



ST2310HI

HIGH VOLTAGE FAST-SWITCHING NPN POWER TRANSISTOR

- NEW SERIES, ENHANCED PERFORMANCE
- FULLY INSULATED PACKAGE (U.L. COMPLIANT) FOR EASY MOUNTING
- HIGH VOLTAGE CAPABILITY (> 1500 V)
- HIGH SWITCHING SPEED
- TIGHTER h_{fe} CONTROL
- IMPROVED RUGGEDNESS

APPLICATIONS:

- HORIZONTAL DEFLECTION FOR MONITORS 15" AND HIGH END TVS

DESCRIPTION

The device is manufactured using Diffused Collector technology for more stable operation Vs base drive circuit variations resulting in very low worst case dissipation.

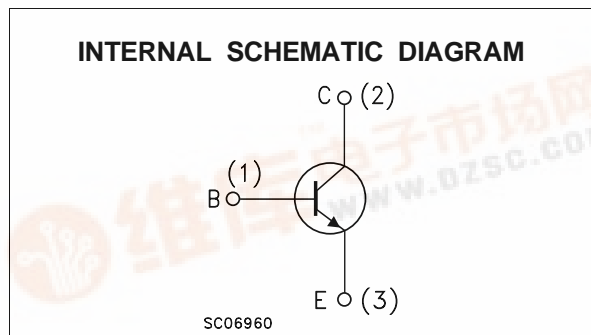
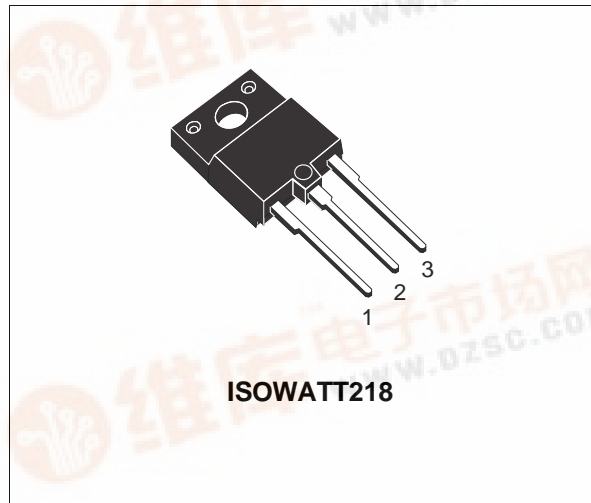

ABSOLUTE MAXIMUM RATINGS

Symbol	Parameter	Value	Unit
V_{CES}	Collector-Emitter Voltage ($V_{BE} = 0$)	1500	V
V_{CEO}	Collector-Emitter Voltage ($I_B = 0$)	600	V
V_{EBO}	Emitter-Base Voltage ($I_C = 0$)	7	V
I_C	Collector Current	12	A
I_{CM}	Collector Peak Current ($t_p < 5$ ms)	25	A
I_B	Base Current	7	A
P_{tot}	Total Dissipation at $T_C = 25$ °C	55	W
V_{isol}	Insulation Withstand Voltage (RMS) from All Three Leads to External Heatsink	2500	V
T_{stg}	Storage Temperature	-65 to 150	°C
T_j	Max. Operating Junction Temperature	150	°C



ST2310HI

THERMAL DATA

$R_{thj-case}$	Thermal Resistance Junction-case	Max	2.3	°C/W
----------------	----------------------------------	-----	-----	------

ELECTRICAL CHARACTERISTICS ($T_{case} = 25\text{ °C}$ unless otherwise specified)

Symbol	Parameter	Test Conditions	Min.	Typ.	Max.	Unit
I_{CES}	Collector Cut-off Current ($V_{BE} = 0$)	$V_{CE} = 1500\text{ V}$ $V_{CE} = 1500\text{ V}$ $T_J = 125\text{ °C}$			1 2	mA mA
I_{EBO}	Emitter Cut-off Current ($I_C = 0$)	$V_{EB} = 7\text{ V}$			1	mA
$V_{CE(sus)}^*$	Collector-Emitter Sustaining Voltage ($I_B = 0$)	$I_C = 100\text{ mA}$ $L = 25\text{ mH}$	600			V
$V_{CE(sat)}^*$	Collector-Emitter Saturation Voltage	$I_C = 7\text{ A}$ $I_B = 1.75\text{ A}$			3	V
$V_{BE(sat)}^*$	Base-Emitter Saturation Voltage	$I_C = 7\text{ A}$ $I_B = 1.75\text{ A}$			1.1	V
h_{FE}^*	DC Current Gain	$I_C = 1\text{ A}$ $V_{CE} = 5\text{ V}$ $I_C = 7\text{ A}$ $V_{CE} = 1\text{ V}$ $I_C = 7\text{ A}$ $V_{CE} = 5\text{ V}$	6.5	25 5.4	9.5	
t_s t_f	INDUCTIVE LOAD Storage Time Fall Time	$I_C = 6\text{ A}$ $f_h = 64\text{ KHz}$ $I_{B(on)} = 1\text{ A}$ $V_{BE(off)} = -2.5\text{ V}$ $L_{B(off)} = 1.3\text{ }\mu\text{H}$ (see figure 1)		2.3 0.16	3 0.35	μs μs

* Pulsed: Pulse duration = 300 μs , duty cycle 1.5 %

Safe Operating Area

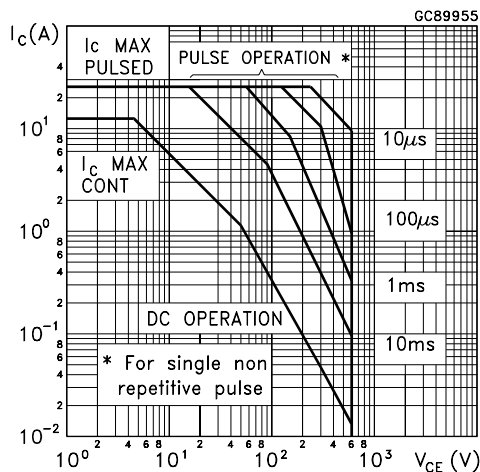

Thermal Impedance

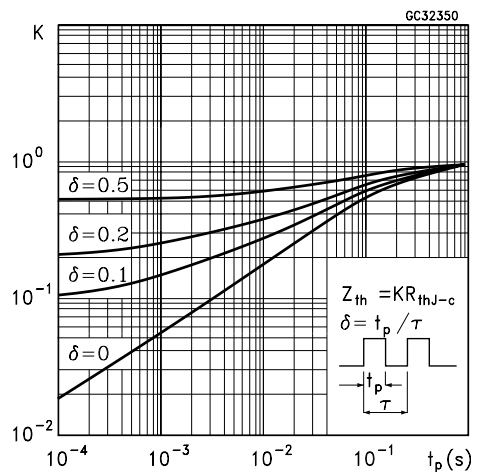

Derating Curve

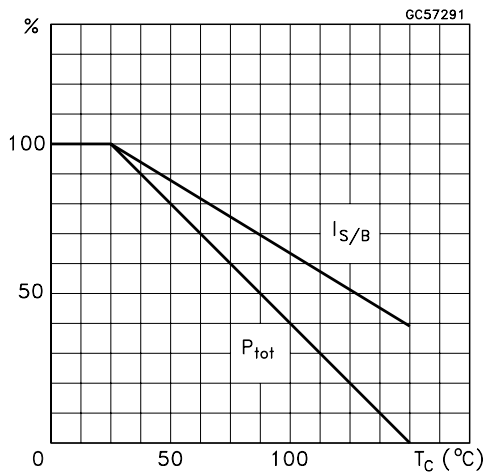

Output Characteristics

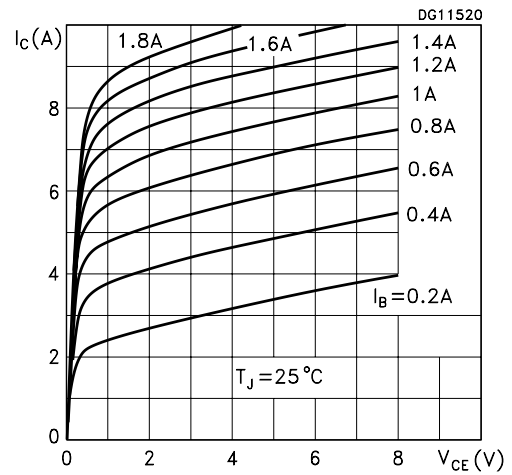

Collector Emitter Saturation Voltage

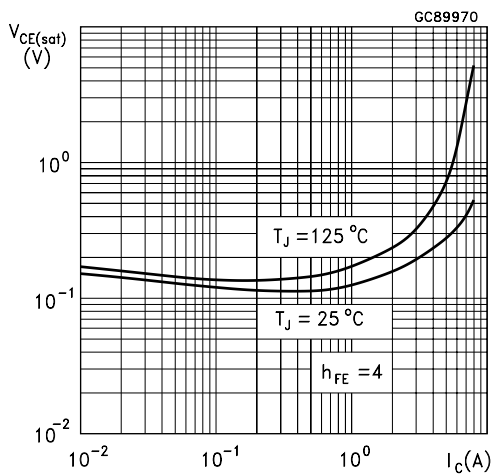

Base Emitter Saturation Voltage

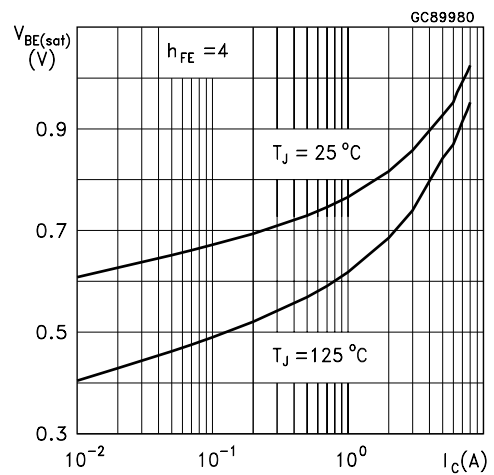

DC Current Gain

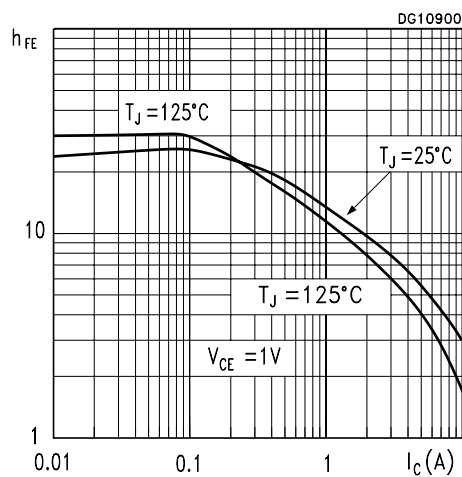

DC Current Gain

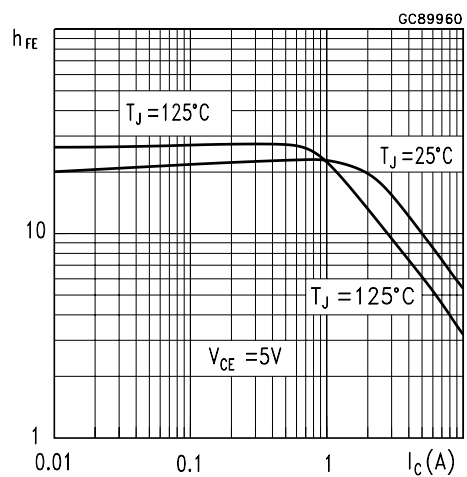

Power Losses

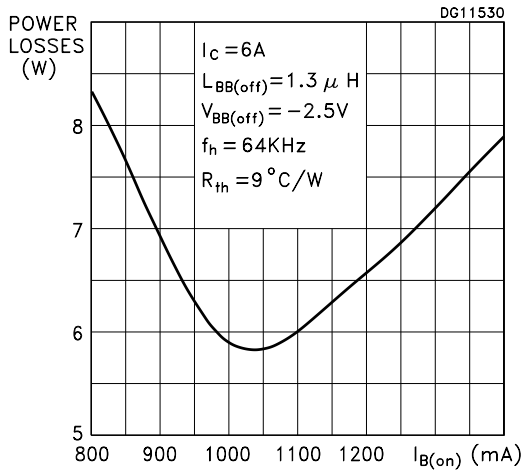

Switching Time Inductive Load

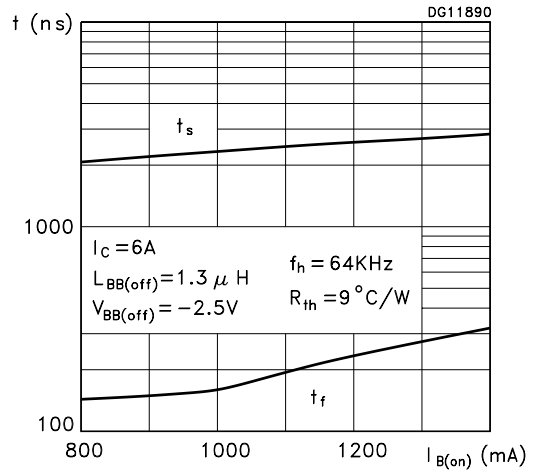

Reverse Biased SOA

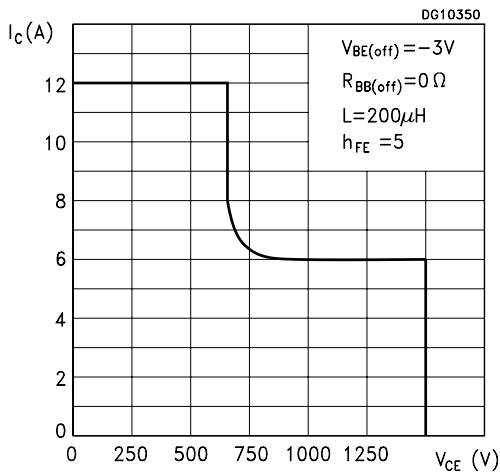
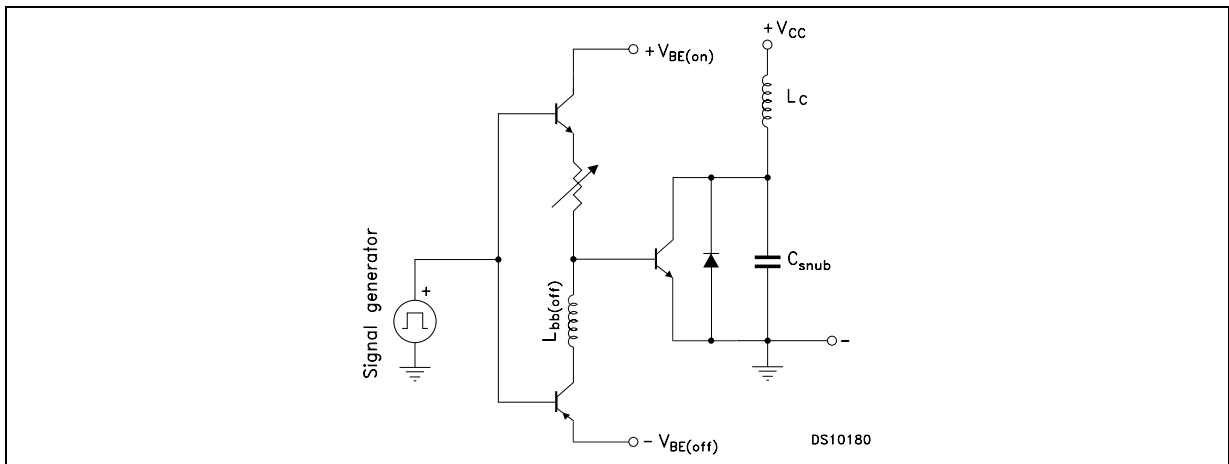
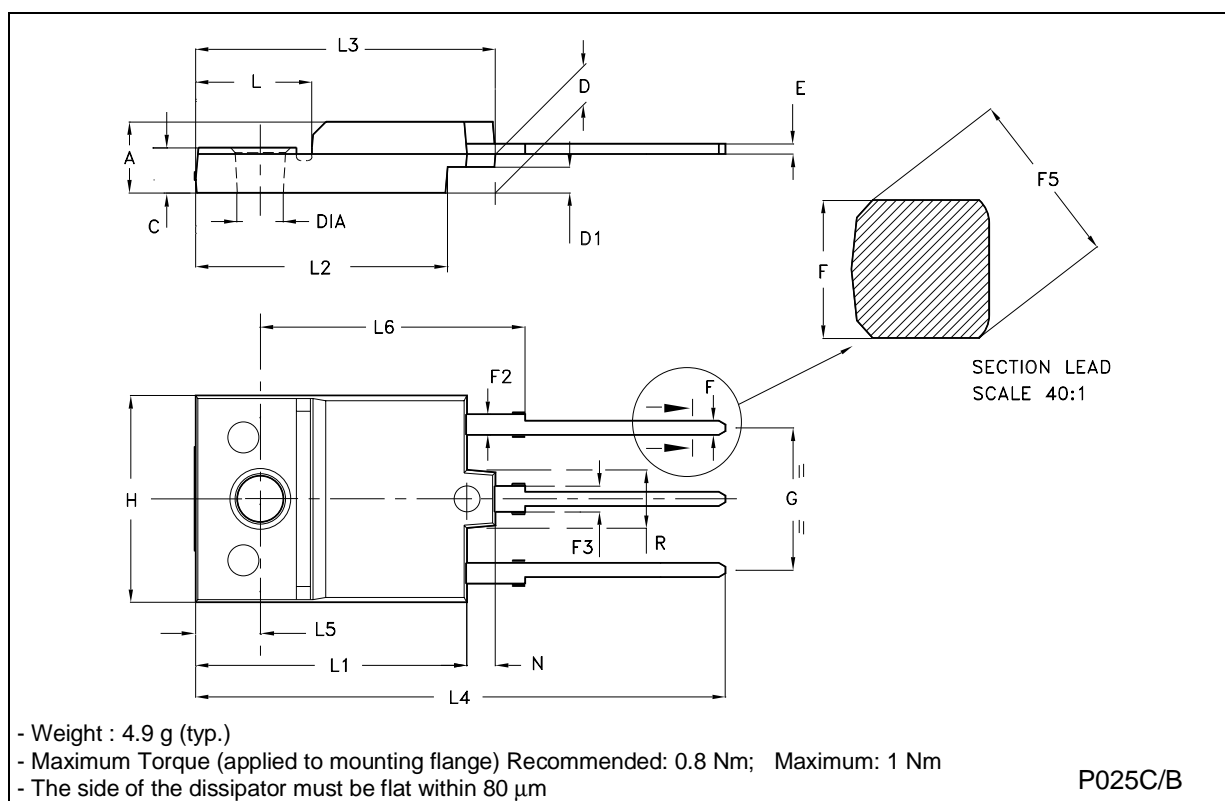

Figure 1: Inductive Load Switching Test Circuit.



ISOWATT218 NARROW LEADS MECHANICAL DATA

DIM.	mm			inch		
	MIN.	TYP.	MAX.	MIN.	TYP.	MAX.
A	5.35		5.65	0.211		0.222
C	3.30		3.80	0.130		0.150
D	2.90		3.10	0.114		0.122
D1	1.88		2.08	0.074		0.082
E	0.75		0.95	0.030		0.037
F	0.75		0.95	0.030		0.037
F2	1.50		1.70	0.059		0.067
F3	1.90		2.10	0.075		0.083
F5			1.10			0.043
G	10.80		11.20	0.425		0.441
H	15.80		16.20	0.622		0.638
L		9			0.354	
L1	20.80		21.20	0.819		0.835
L2	19.10		19.90	0.752		0.783
L3	22.80		23.60	0.898		0.929
L4	40.50		42.50	1.594		1.673
L5	4.85		5.25	0.191		0.207
L6	20.25		20.75	0.797		0.817
N	2.1		2.3	0.083		0.091
R		4.6			0.181	
DIA	3.5		3.7	0.138		0.146



Information furnished is believed to be accurate and reliable. However, STMicroelectronics assumes no responsibility for the consequences of use of such information nor for any infringement of patents or other rights of third parties which may result from its use. No license is granted by implication or otherwise under any patent or patent rights of STMicroelectronics. Specification mentioned in this publication are subject to change without notice. This publication supersedes and replaces all information previously supplied. STMicroelectronics products are not authorized for use as critical components in life support devices or systems without express written approval of STMicroelectronics.

The ST logo is a trademark of STMicroelectronics

© 2002 STMicroelectronics – Printed in Italy – All Rights Reserved
STMicroelectronics GROUP OF COMPANIES

Australia - Brazil - Canada - China - Finland - France - Germany - Hong Kong - India - Israel - Italy - Japan - Malaysia - Malta - Morocco -
Singapore - Spain - Sweden - Switzerland - United Kingdom - United States.

<http://www.st.com>