



# T2550H-600T

SNUBBERLESS™ HIGH TEMPERATURE

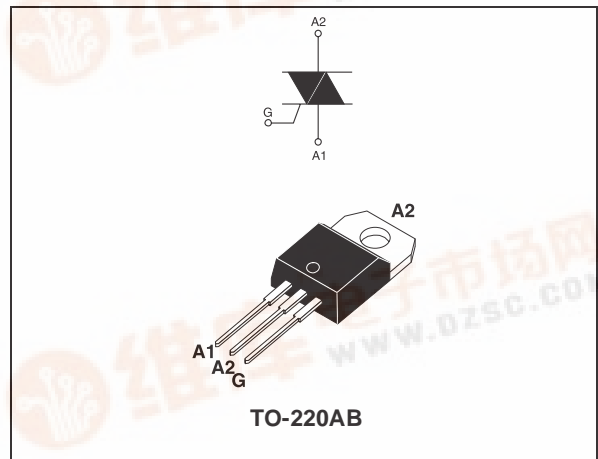
25A TRIACs

### MAIN FEATURES:

Symbol	Value	Unit
$I_{T(RMS)}$	25	A
$V_{DRM}/V_{RRM}$	600	V
$I_{GT}(Q_1)$	50	mA

### DESCRIPTION

Specifically designed for use in high temperature environment (found in hot appliances such as cookers, ovens, hobs, electric heaters, coffee machines...), the new 25 Amps T25500H triacs provide an enhanced performance in terms of power loss and thermal dissipation. This allows optimization of the heatsinking dimensioning, leading to space and cost effectiveness when compared to electro-mechanical solutions. Based on ST snubberless technology, they offer high commutation switching capabilities and high noise immunity levels. And, thanks to their clip assembly technique, they provide a superior performance in surge current handling.



### ABSOLUTE MAXIMUM RATINGS

Symbol	Parameter		Value	Unit
$I_{T(RMS)}$	RMS on-state current (full sine wave)		$T_c = 125^\circ\text{C}$ 25	A
$I_{TSM}$	Non repetitive surge peak on-state current (full cycle, $T_j$ initial = $25^\circ\text{C}$ )	F = 60 Hz    t = 16.7 ms	260	A
		F = 50 Hz    t = 20 ms	250	
$I^2t$	$I^2t$ Value for fusing	tp = 10 ms	340	$\text{A}^2\text{s}$
di/dt	Critical rate of rise of on-state current $I_G = 2 \times I_{GT}$ , tr ≤ 100 ns	F = 120 Hz $T_j = 150^\circ\text{C}$	50	A/μs
$V_{DSM}/V_{RSM}$	Non repetitive surge peak off-state voltage	tp = 10 ms $T_j = 25^\circ\text{C}$	700	V
$I_{GM}$	Peak gate current	tp = 20 μs $T_j = 150^\circ\text{C}$	4	A
$P_{G(AV)}$	Average gate power dissipation	$T_j = 150^\circ\text{C}$	1	W
$T_{stg}$ $T_j$	Storage junction temperature range Operating junction temperature range		- 40 to + 150 - 40 to + 150	$^\circ\text{C}$



## T2550H-600T

### ELECTRICAL CHARACTERISTICS (T<sub>j</sub> = 25°C, unless otherwise specified)

Symbol	Test Conditions	Quadrant		Value	Unit
I <sub>GT</sub> (1)	V <sub>D</sub> = 12 V    R <sub>L</sub> = 33 Ω	I - II - III	MAX.	50	mA
V <sub>GT</sub>		I - II - III	MAX.	1.3	V
V <sub>GD</sub>	V <sub>D</sub> = V <sub>DRM</sub> R <sub>L</sub> = 3.3 kΩ    T <sub>j</sub> = 150°C	I - II - III	MIN.	0.15	V
I <sub>H</sub> (2)	I <sub>T</sub> = 500 mA		MAX.	75	mA
I <sub>L</sub>	I <sub>G</sub> = 1.2 I <sub>GT</sub>	I - II - III	MAX.	90	mA
dV/dt (2)	V <sub>D</sub> = 67 % V <sub>DRM</sub> gate open    T <sub>j</sub> = 150°C		MIN.	500	V/μs
(dI/dt) <sub>c</sub> (2)	Without snubber    T <sub>j</sub> = 150°C		MIN.	11.1	A/ms

### STATIC CHARACTERISTICS

Symbol	Test Conditions		Value	Unit	
V <sub>TM</sub> (2)	I <sub>TM</sub> = 35 A    t <sub>p</sub> = 380 μs	T <sub>j</sub> = 25°C	MAX.	1.5	V
V <sub>to</sub> (2)	Threshold voltage		MAX.	0.80	V
R <sub>d</sub> (2)	Dynamic resistance		MAX.	19	mΩ
I <sub>DRM</sub> I <sub>RRM</sub>	V <sub>DRM</sub> = V <sub>RRM</sub>  V <sub>DRM</sub> / V <sub>RRM</sub> = 400 V (at mains peak voltage)	T <sub>j</sub> = 25°C	MAX.	5	μA
		T <sub>j</sub> = 150°C		8.5	mA
T <sub>j</sub> = 150°C	5.5				

**Note 1:** minimum IGT is guaranteed at 10% of IGT max.

**Note 2:** for both polarities of A2 referenced to A1

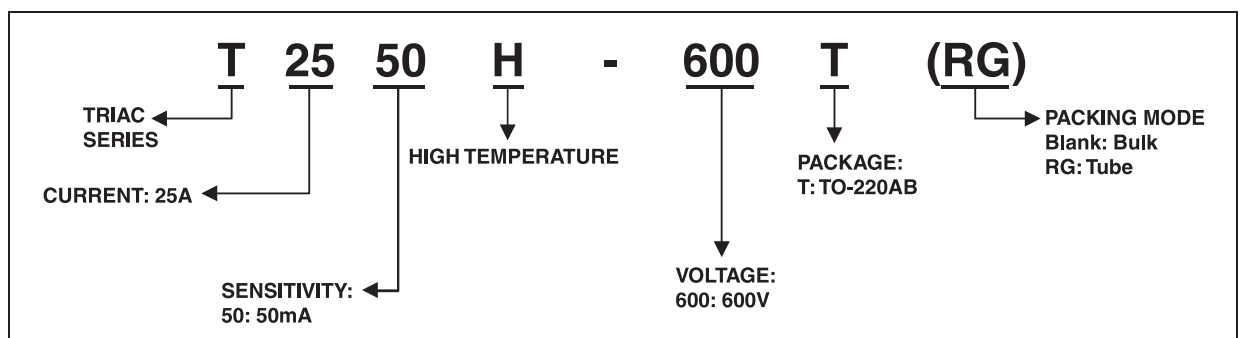
### THERMAL RESISTANCE

Symbol	Parameter	Value	Unit
R <sub>th(j-c)</sub>	Junction to case (AC)	0.8	°C/W

### PRODUCT SELECTOR

Part Number	Voltage	Sensitivity	Type	Package
T2550H-600T	600 V	50 mA	Snubberless	TO-220AB

### ORDERING INFORMATION



OTHER INFORMATION

Part Number	Marking	Weight	Base quantity	Packing mode
T2550H-600T	T2550H600T	2.3 g	250	Bulk
T2550H-600TRG	T2550H600T	2.3 g	50	Tube

Fig. 1: Maximum power dissipation versus RMS on-state current (full cycle).

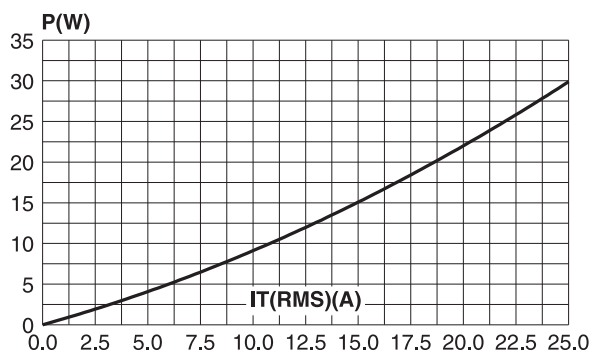


Fig. 3: Relative variation of thermal impedance versus pulse duration.

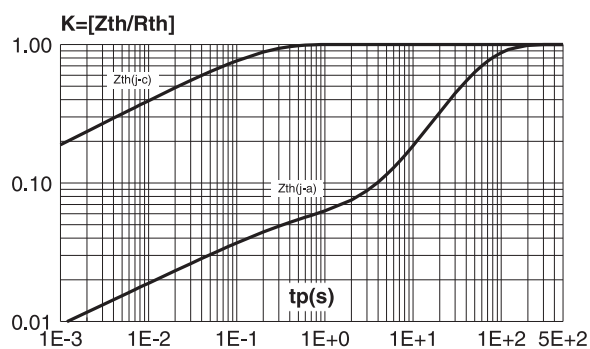


Fig. 2: RMS on-state current versus case temperature (full cycle).

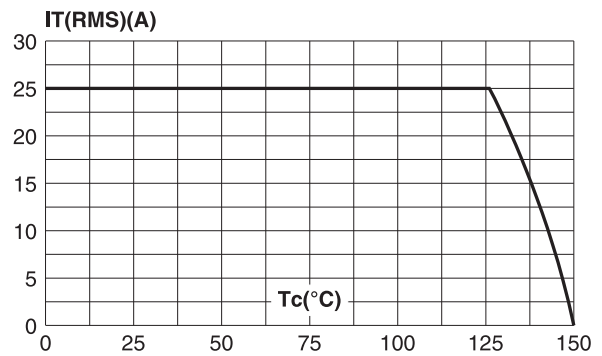
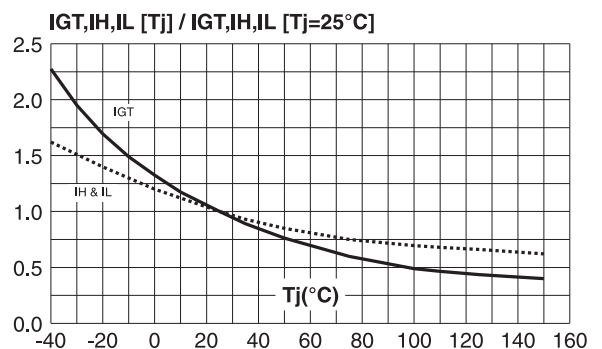
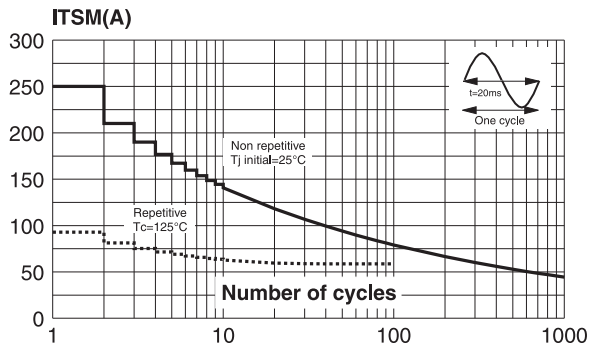


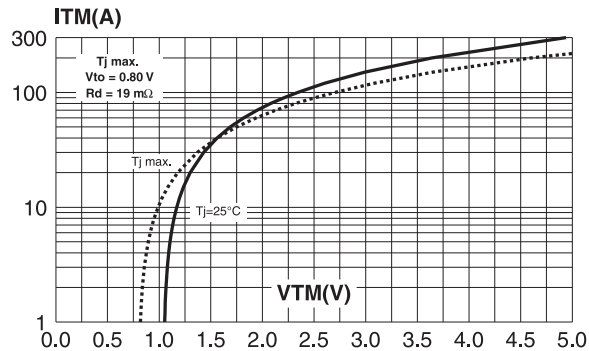
Fig. 4: Relative variation of gate trigger current, holding current and latching current versus junction temperature (typical values).



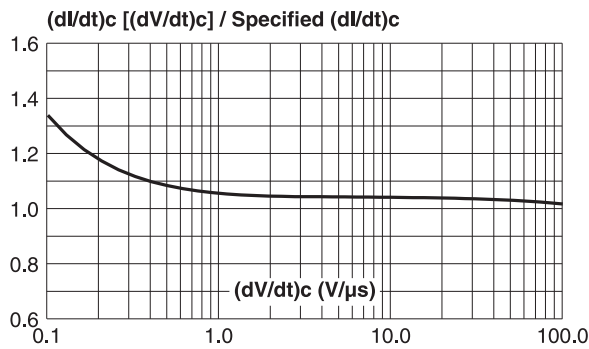
**Fig. 5:** Surge peak on-state current versus number of cycles.



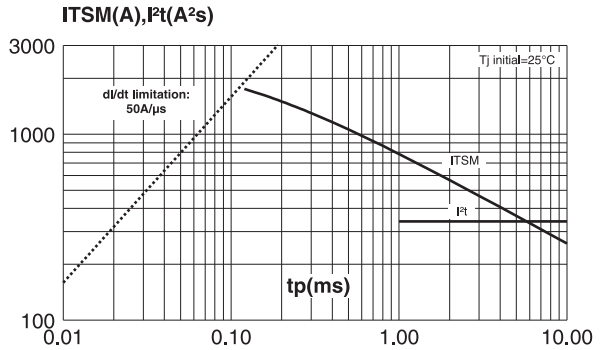
**Fig. 7:** On-state characteristics (maximum values).



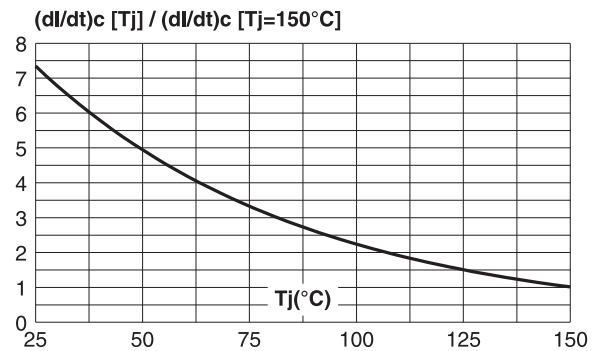
**Fig. 9:** Relative variation of critical rate of decrease of main current versus (dV/dt)c (typical values).



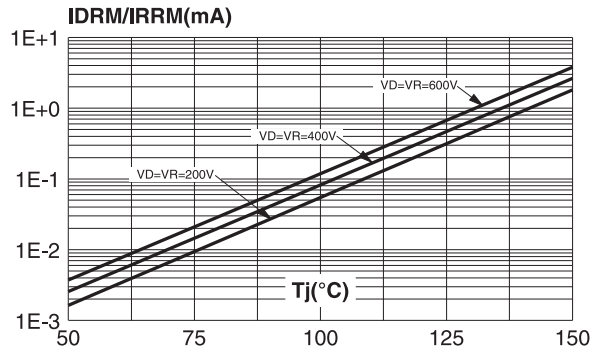
**Fig. 6:** Non-repetitive surge peak on-state current for a sinusoidal pulse with width  $t_p < 10\text{ms}$ , and corresponding value of  $I^2t$ .



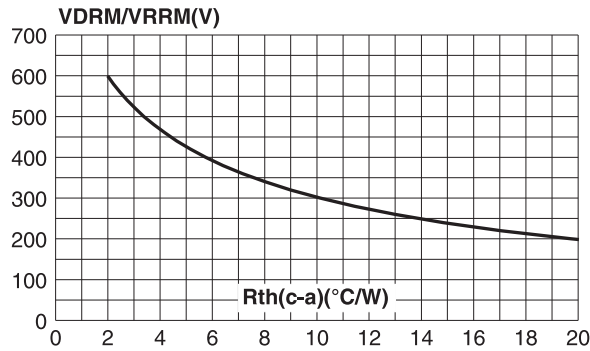
**Fig. 8:** Relative variation of critical rate of decrease of main current versus junction temperature (typical values).



**Fig. 10:** Leakage current versus junction temperature for different values of blocking voltage (typical values).

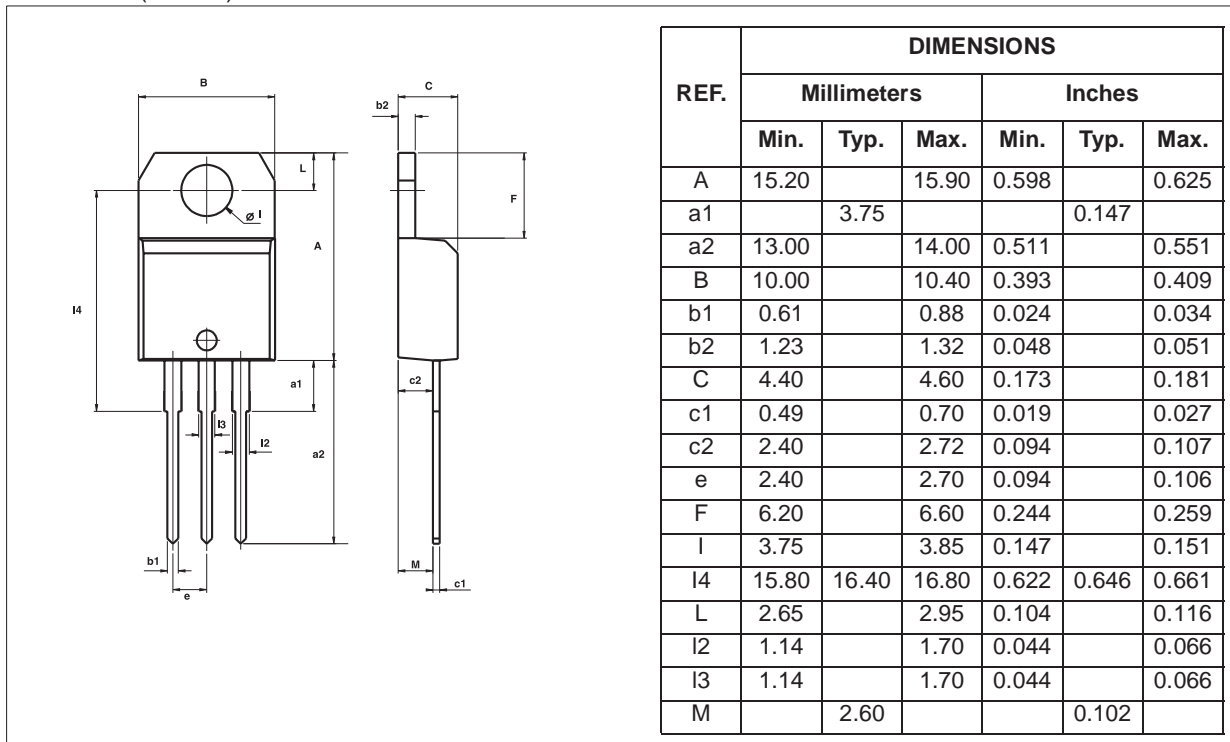


**Fig. 11:** Acceptable repetitive peak off-state voltage versus case-ambient thermal resistance.



**PACKAGE MECHANICAL DATA**

TO-220AB (Plastic)



Information furnished is believed to be accurate and reliable. However, STMicroelectronics assumes no responsibility for the consequences of use of such information nor for any infringement of patents or other rights of third parties which may result from its use. No license is granted by implication or otherwise under any patent or patent rights of STMicroelectronics. Specifications mentioned in this publication are subject to change without notice. This publication supersedes and replaces all information previously supplied. STMicroelectronics products are not authorized for use as critical components in life support devices or systems without express written approval of STMicroelectronics.

© The ST logo is a registered trademark of STMicroelectronics

© 2002 STMicroelectronics - Printed in Italy - All Rights Reserved

STMicroelectronics GROUP OF COMPANIES  
 Australia - Brazil - Canada - China - Finland - France - Germany  
 Hong Kong - India - Israel - Italy - Japan - Malaysia - Malta - Morocco - Singapore  
 Spain - Sweden - Switzerland - United Kingdom - United States.

<http://www.st.com>