



STPS340U/S/B

POWER SCHOTTKY RECTIFIER

MAIN PRODUCT CHARACTERISTICS

I_{F(AV)}	3 A
V_{RRM}	40 V
T_j (max)	150 °C
V_F (max)	0.57 V

FEATURES AND BENEFITS

- VERY SMALL CONDUCTION LOSSES
- NEGLIGIBLE SWITCHING LOSSES
- LOW FORWARD VOLTAGE DROP
- LOW THERMAL RESISTANCE
- EXTREMELY FAST SWITCHING
- SURFACE MOUNTED DEVICE
- AVALANCHE CAPABILITY SPECIFIED

DESCRIPTION

Single chip Schottky rectifier suited for Switch Mode Power Supplies and high frequency DC to DC converters.

Packaged in SMB, SMC and DPAK this device is intended for use in low and medium voltage operation, high frequency inverters, free wheeling and polarity protection applications where low switching losses are required.

ABSOLUTE RATINGS (limiting values)

Symbol	Parameter		Value	Unit	
V _{RRM}	Repetitive peak reverse voltage		40	V	
I _{F(RMS)}	RMS forward current		DPAK	6	A
			SMB / SMC	10	
I _{F(AV)}	Average forward current	T _c = 135°C δ = 0.5	DPAK	3	A
		T _L = 105°C δ = 0.5	SMB / SMC		
I _{FSM}	Surge non repetitive forward current	tp = 10 ms Sinusoidal	75	A	
I _{RRM}	Repetitive peak reverse current	tp = 2 μs F = 1kHz square	1	A	
P _{ARM}	Repetitive peak avalanche power	tp = 1μs T _j = 25°C	1300	W	
T _{stg}	Storage temperature range		- 65 to + 150	°C	
T _j	Maximum operating junction temperature		+ 150	°C	
dV/dt	Critical rate of rise of reverse voltage		10000	V/μs	

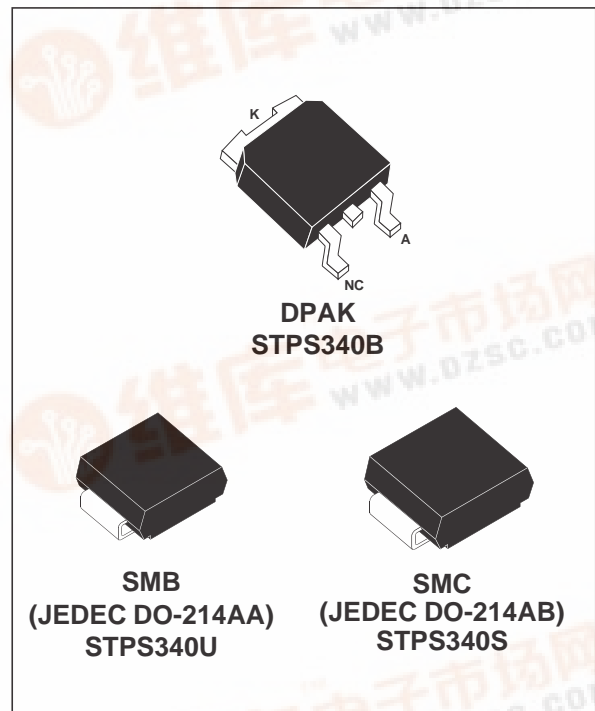

STPS340U/S/B

THERMAL RESISTANCES

Symbol	Parameter		Value	Unit
$R_{th(j-l)}$	Junction to leads	SMC	20	$^{\circ}\text{C}/\text{W}$
		SMB	25	
$R_{th(j-c)}$	Junction to case	DPAK	5.5	$^{\circ}\text{C}/\text{W}$

STATIC ELECTRICAL CHARACTERISTICS

Symbol	Tests Conditions	Tests Conditions	Min.	Typ.	Max.	Unit
I_R^*	Reverse leakage current	$T_j = 25^{\circ}\text{C}$ $V_R = V_{RRM}$			20	μA
		$T_j = 125^{\circ}\text{C}$ $V_R = V_{RRM}$		2	10	mA
V_F^*	Forward voltage drop	$T_j = 25^{\circ}\text{C}$ $I_F = 3\text{ A}$			0.63	V
		$T_j = 25^{\circ}\text{C}$ $I_F = 6\text{ A}$			0.84	
		$T_j = 125^{\circ}\text{C}$ $I_F = 3\text{ A}$		0.52	0.57	
		$T_j = 125^{\circ}\text{C}$ $I_F = 6\text{ A}$		0.63	0.72	

Pulse test : * $t_p = 380\ \mu\text{s}$, $\delta < 2\%$

To evaluate the maximum conduction losses use the following equation :

$$P = 0.42 \times I_{F(AV)} + 0.050 I_{F(RMS)}^2$$

Fig. 1: Average forward power dissipation versus average forward current.

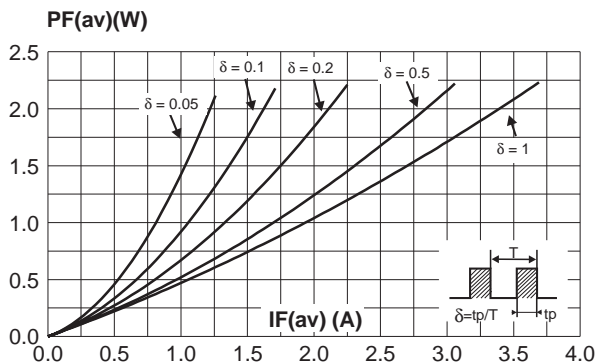

Fig. 3: Normalized avalanche power derating versus pulse duration.

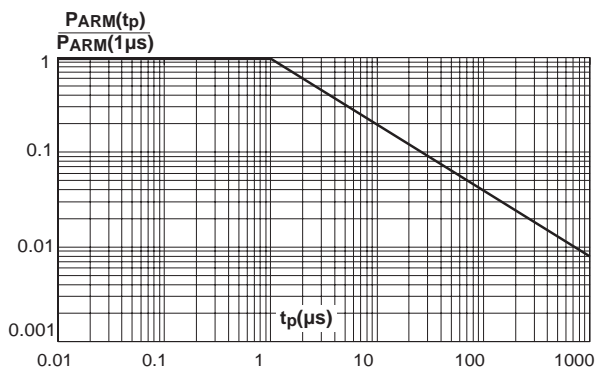

Fig. 2: Average current versus ambient temperature ($\delta = 0.5$).

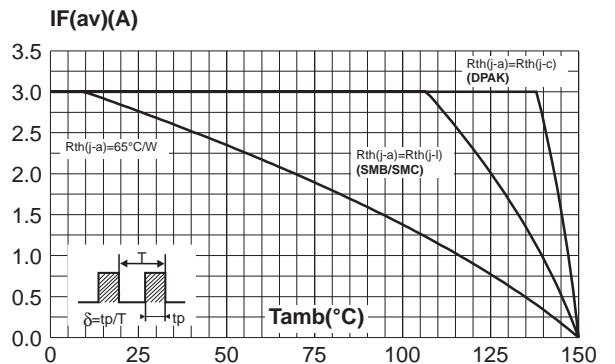

Fig. 4: Normalized avalanche power derating versus junction temperature.

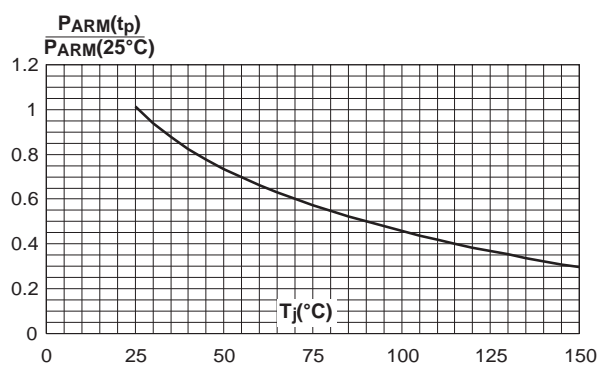

Fig. 5-1: Non repetitive surge peak forward current versus overload duration (SMB)(Maximum values).

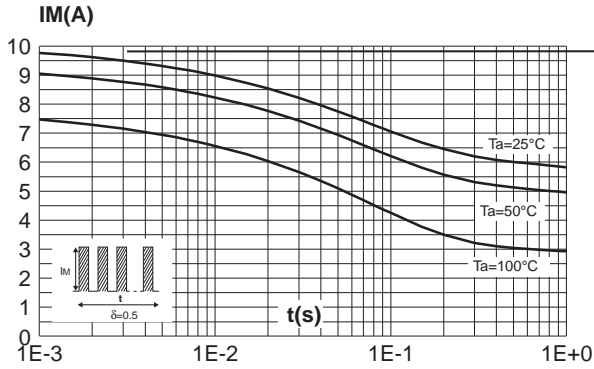

Fig. 5-2: Non repetitive surge peak forward current versus overload duration (SMC) (Maximum values).

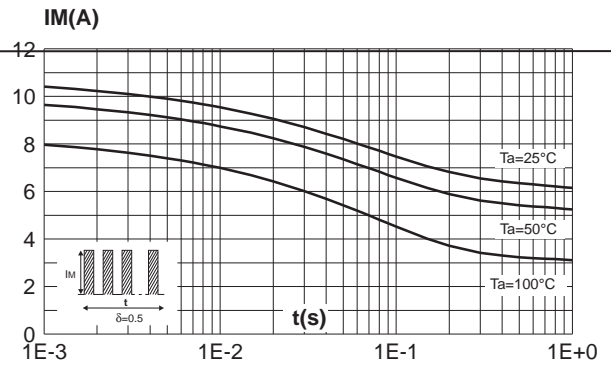

Fig. 5-3: Non repetitive surge peak forward current versus overload duration (DPAK) (Maximum values).

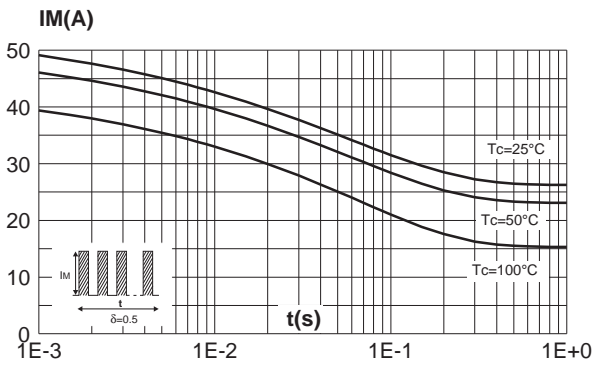

Fig. 6-1: Relative variation of thermal transient impedance junction to lead versus pulse duration (SMB).

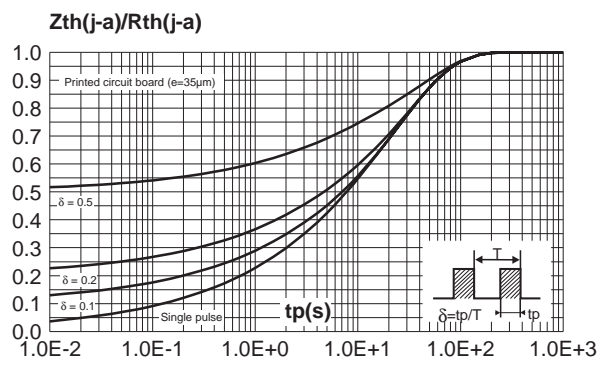

Fig. 6-2: Relative variation of thermal transient impedance junction to lead versus pulse duration (SMC).

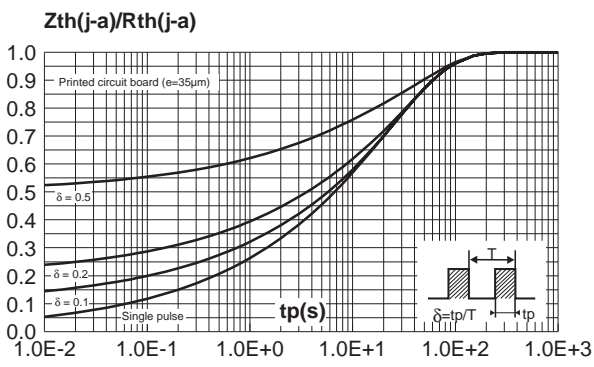
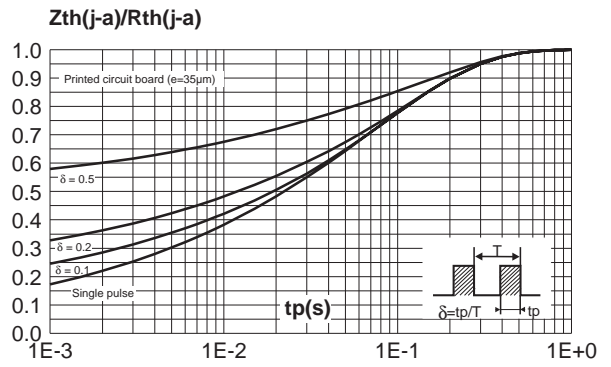

Fig. 6-3: Relative variation of thermal transient impedance junction to lead versus pulse duration(DPAK).



STPS340U/S/B

Fig. 7: Reverse leakage current versus reverse voltage applied (Typical values).

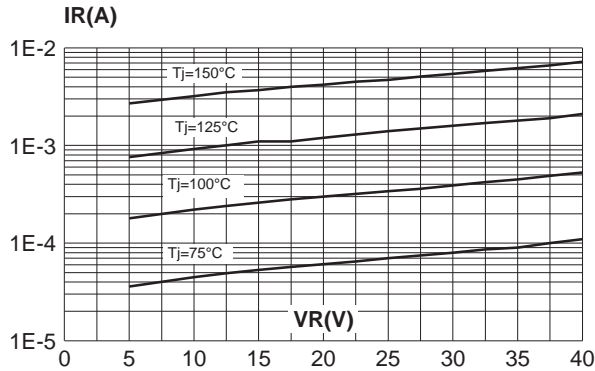

Fig. 8: Junction capacitance versus reverse voltage applied (Typical values).

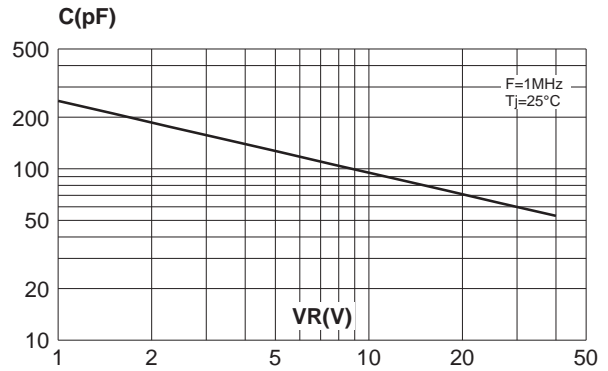

Fig. 9: Forward voltage drop versus forward current (Maximum values).

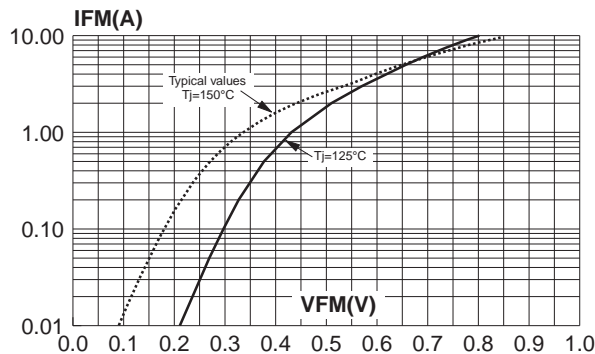

Fig. 10-1: Thermal resistance junction to ambient versus copper surface under each lead (Epoxy printed circuit board FR4, copper thickness: $35\mu\text{m}$) (SMB).

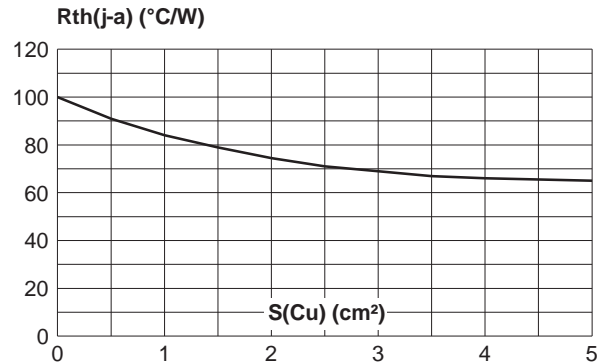

Fig. 10-2: Thermal resistance junction to ambient versus copper surface under each lead (Epoxy printed circuit board FR4, copper thickness: $35\mu\text{m}$) (SMC).

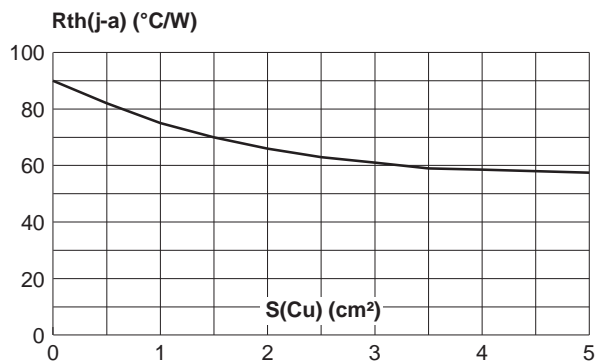
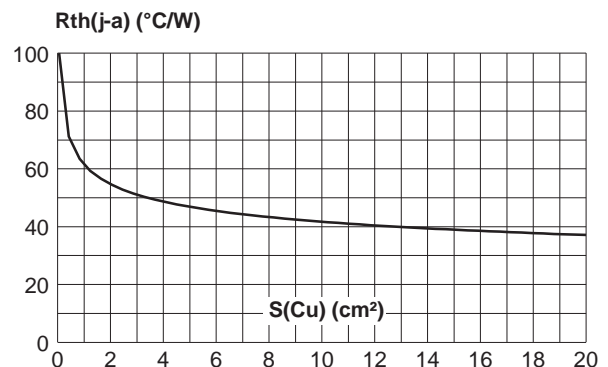
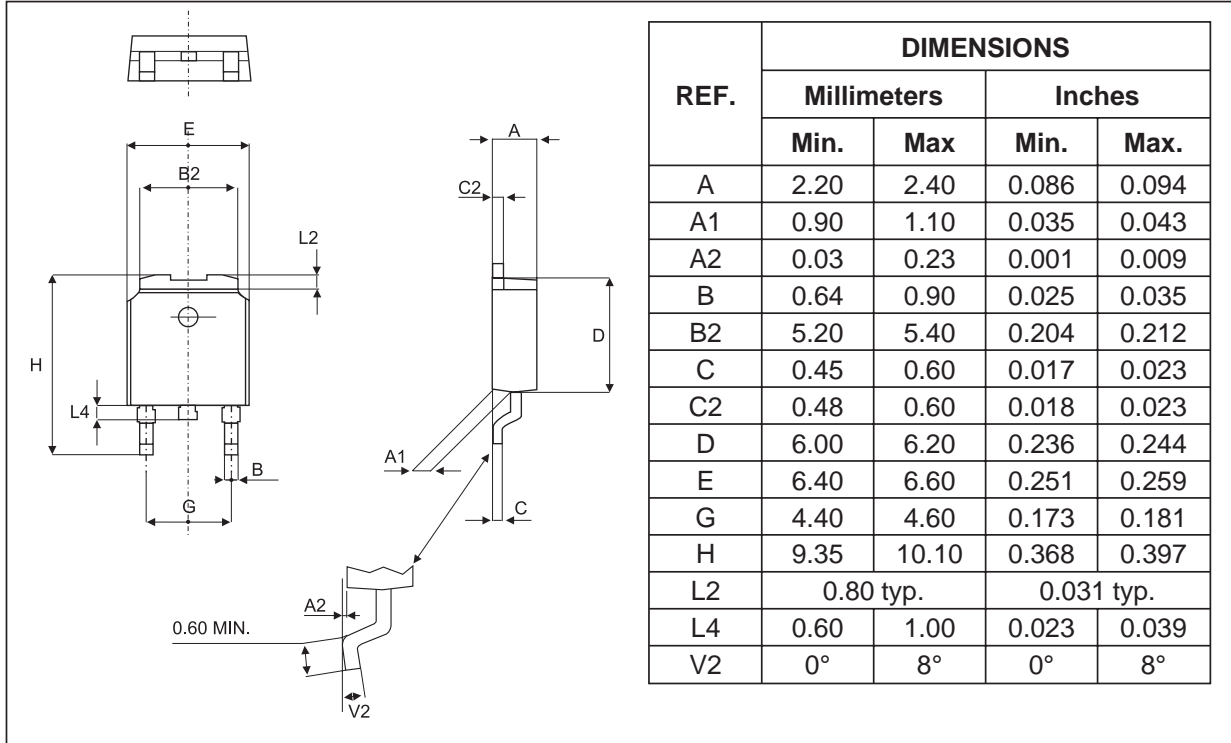

Fig. 10-3: Thermal resistance junction to ambient versus copper surface under each lead (Epoxy printed circuit board FR4, copper thickness: $35\mu\text{m}$) (DPAK).



PACKAGE MECHANICAL DATA
DPAK



FOOTPRINT DIMENSIONS (in millimeters)

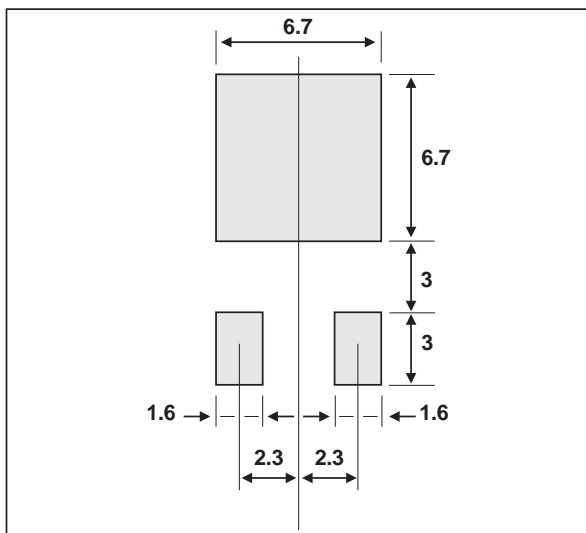

STPS340U/S/B

PACKAGE MECHANICAL DATA SMB

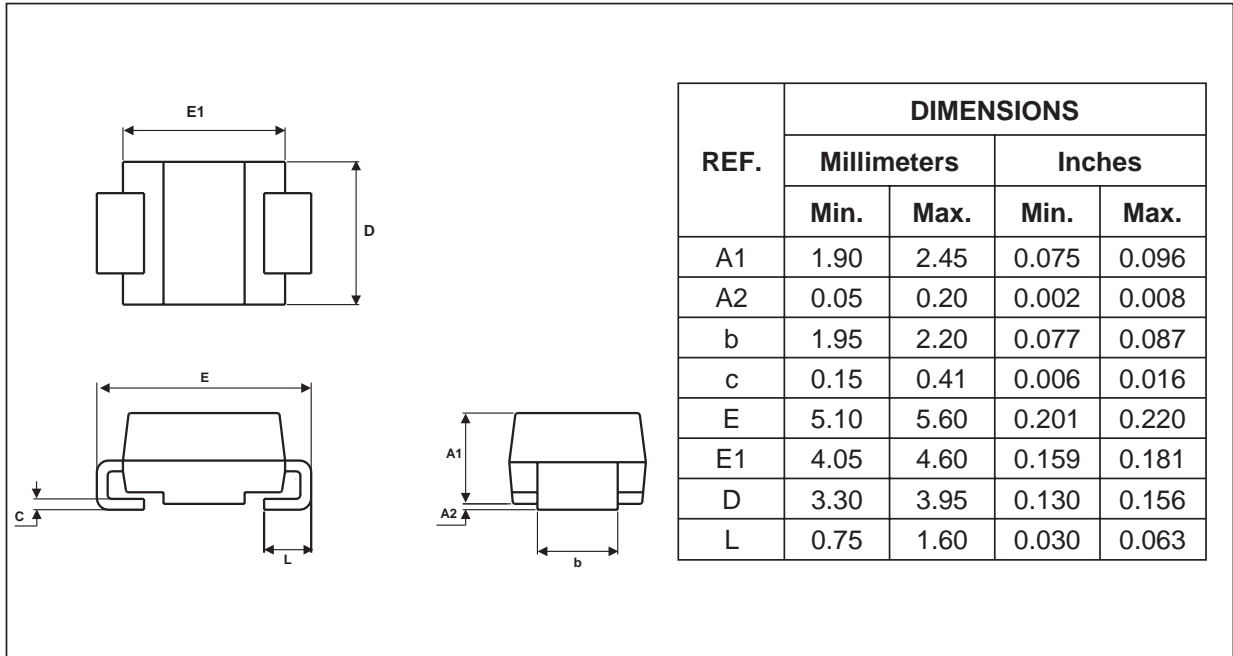

FOOTPRINT DIMENSIONS (in millimeters)

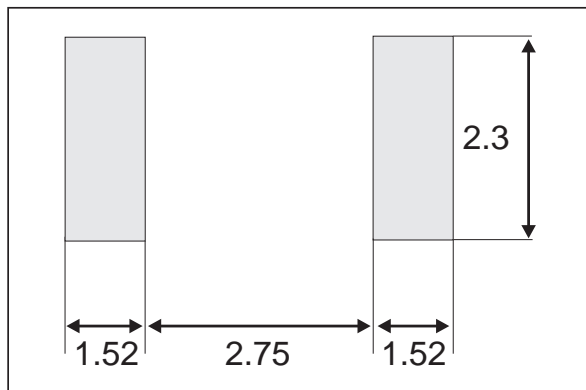

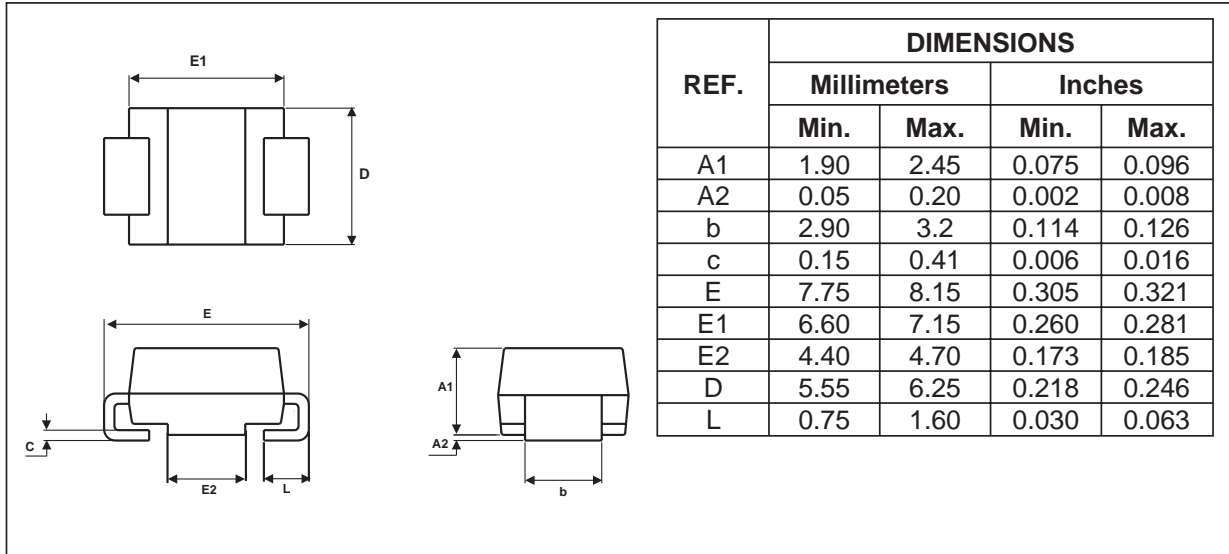
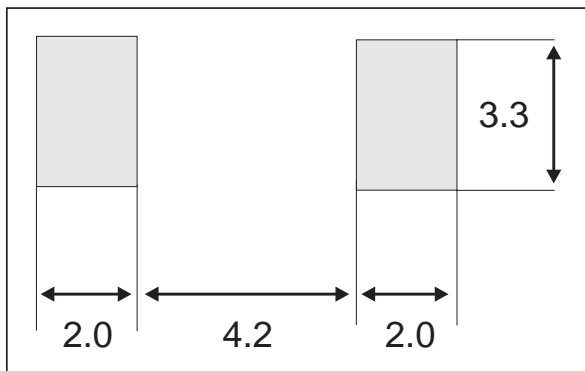
PACKAGE MECHANICAL DATA
 SMC

FOOTPRINT DIMENSIONS (in millimeters)

Ordering type	Marking	Package	Weight	Base qty	Delivery mode
STPS340U	U34	SMB	0.107g	2500	Tape and reel
STPS340S	S34	SMC	0.243g	2500	Tape and reel
STPS340B	S340	DPAK	0.30g	75	Tube
STPS340B-TR	S340	DPAK	0.30g	2500	Tape and reel

- BAND INDICATES CATHODE ON SMB, SMC
- EPOXY MEETS UL94,V0

Information furnished is believed to be accurate and reliable. However, STMicroelectronics assumes no responsibility for the consequences of use of such information nor for any infringement of patents or other rights of third parties which may result from its use. No license is granted by implication or otherwise under any patent or patent rights of STMicroelectronics. Specifications mentioned in this publication are subject to change without notice. This publication supersedes and replaces all information previously supplied.

STMicroelectronics products are not authorized for use as critical components in life support devices or systems without express written approval of STMicroelectronics.

The ST logo is a registered trademark of STMicroelectronics

© 2003 STMicroelectronics - Printed in Italy - All rights reserved.

STMicroelectronics GROUP OF COMPANIES

Australia - Brazil - Canada - China - Finland - France - Germany
 Hong Kong - India - Israel - Italy - Japan - Malaysia - Malta - Morocco - Singapore
 Spain - Sweden - Switzerland - United Kingdom - United States.

<http://www.st.com>