



STPS745D/F/G/FP

POWER SCHOTTKY RECTIFIER

MAIN PRODUCT CHARACTERISTICS

I_{F(AV)}	7.5 A
V_{RRM}	45 V
T_{j (max)}	175 °C
V_{F (max)}	0.57 V

FEATURES AND BENEFITS

- VERY SMALL CONDUCTION LOSSES
- NEGLIGIBLE SWITCHING LOSSES
- EXTREMELY FAST SWITCHING
- INSULATED PACKAGE: ISOWATT220AC, TO-220FPAC
Insulating voltage = 2000V DC
Capacitance = 12pF
- AVALANCHE CAPABILITY SPECIFIED

DESCRIPTION

Single Schottky rectifier suited for Switch Mode Power Supply and high frequency DC to DC converters.

Packaged either in TO-220AC, ISOWATT220AC, TO-220FPAC or D²PAK, this device is intended for use in low voltage, high frequency inverters, free wheeling and polarity protection applications.

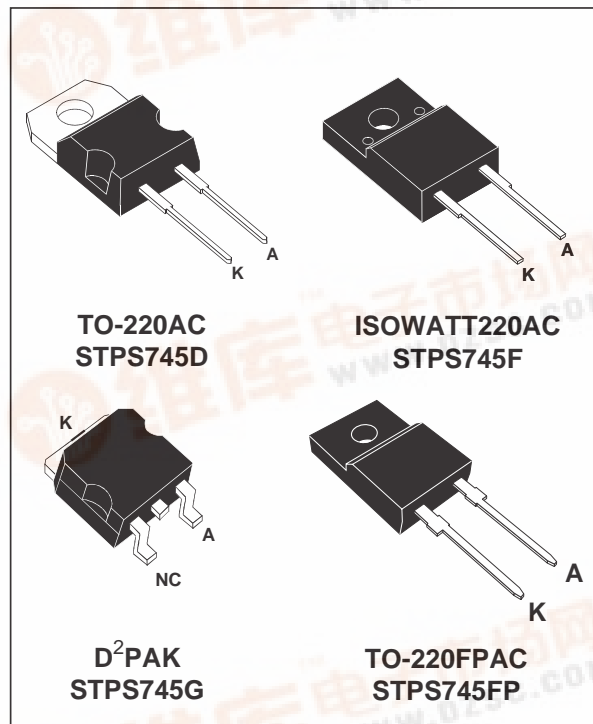

ABSOLUTE RATINGS (limiting values)

Symbol	Parameter		Value	Unit	
V _{RRM}	Repetitive peak reverse voltage		45	V	
I _{F(RMS)}	RMS forward current		20	A	
I _{F(AV)}	Average forward current δ = 0.5	TO-220AC / D ² PAK	T _c = 160°C	7.5	A
		ISOWATT220AC / TO-220FPAC	T _c = 145°C		
I _{FSM}	Surge non repetitive forward current	tp = 10 ms sinusoidal	150	A	
I _{R(RM)}	Repetitive peak reverse current	tp = 2 μs square F = 1kHz	1	A	
I _{R(SM)}	Non repetitive peak reverse current	tp = 100 μs square	2	A	
P _{ARM}	Repetitive peak avalanche power	tp = 1μs T _j = 25°C	2700	W	
T _{stg}	Storage temperature range		- 65 to + 175	°C	
T _j	Maximum operating junction temperature *		175	°C	
dV/dt	Critical rate of rise of reverse voltage		10000	V/μs	

* : $\frac{dP_{tot}}{dT_j} < \frac{1}{R_{th(j-a)}}$ thermal runaway condition for a diode on its own heatsink

STPS745D/F/G/FP

THERMAL RESISTANCES

Symbol	Parameter		Value	Unit
$R_{th(j-c)}$	Junction to case	TO-220AC / D ² PAK	3.0	°C/W
		ISOWATT220AC/ TO-220FPAC	5.5	

STATIC ELECTRICAL CHARACTERISTICS

Symbol	Parameter	Tests Conditions		Min.	Typ.	Max.	Unit
I_R^*	Reverse leakage current	$T_j = 25^\circ\text{C}$	$V_R = V_{RRM}$			100	μA
		$T_j = 125^\circ\text{C}$			5	15	mA
V_F^*	Forward voltage drop	$T_j = 125^\circ\text{C}$	$I_F = 7.5\text{ A}$		0.5	0.57	V
		$T_j = 25^\circ\text{C}$	$I_F = 15\text{ A}$			0.84	
		$T_j = 125^\circ\text{C}$	$I_F = 15\text{ A}$		0.65	0.72	

Pulse test : * $t_p = 380\ \mu\text{s}$, $\delta < 2\%$

To evaluate the conduction losses use the following equation :

$$P = 0.42 \times I_{F(AV)} + 0.020 I_{F(RMS)}^2$$

Fig. 1: Average forward power dissipation versus average forward current.

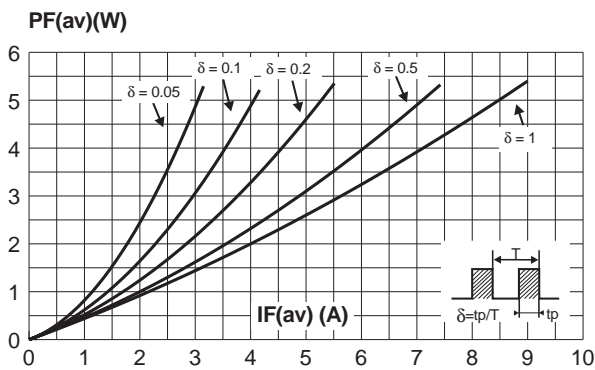

Fig. 2: Average current versus ambient temperature ($\delta = 0.5$).

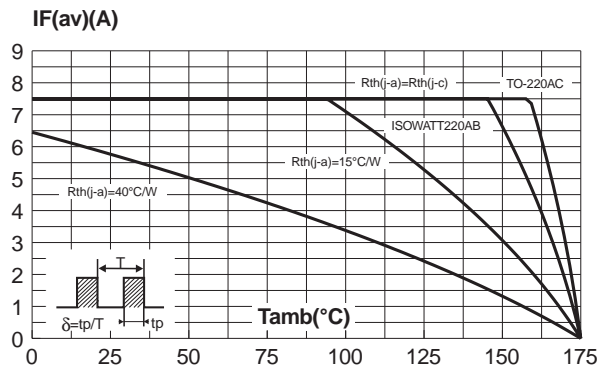

Fig. 3: Normalized avalanche power derating versus pulse duration.

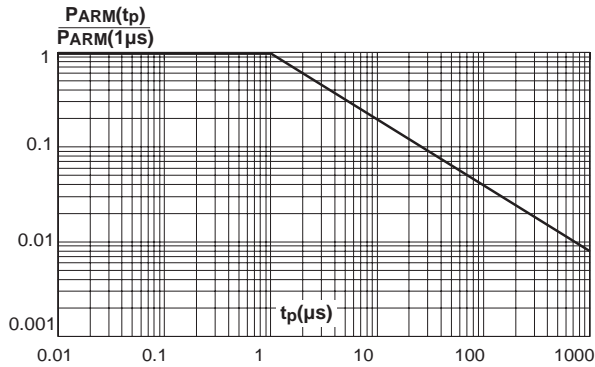

Fig. 4: Normalized avalanche power derating versus junction temperature.

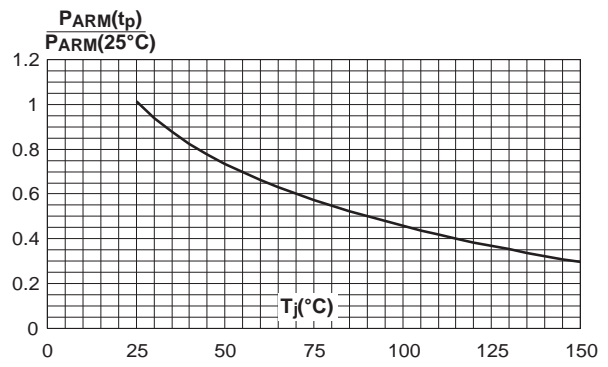

Fig. 5-1: Non repetitive surge peak forward current versus overload duration (maximum values) (TO-220AC and D²PAK).

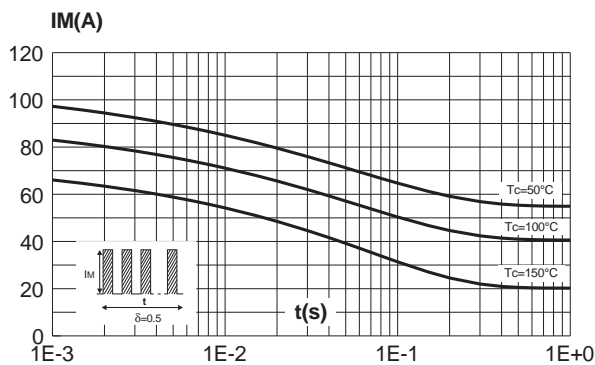

Fig. 5-2: Non repetitive surge peak forward current versus overload duration (maximum values) (ISOWATT220AC/TO-220FPAC).

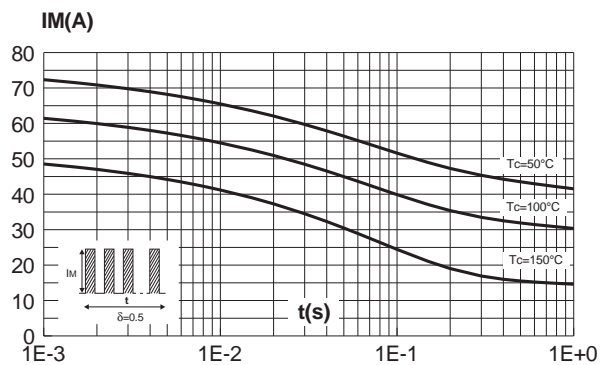

Fig. 6-1: Relative variation of thermal transient impedance junction to case versus pulse duration (TO-220AC and D²PAK).

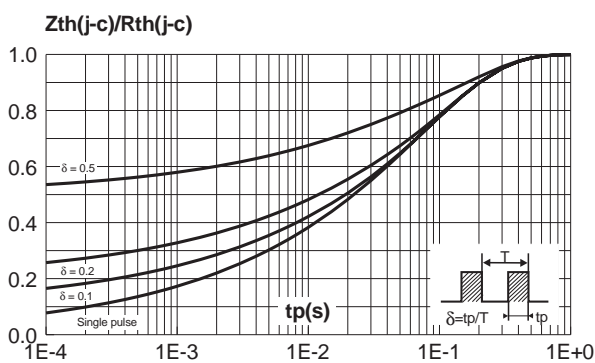

Fig. 6-2: Relative variation of thermal transient impedance junction to case versus pulse duration (ISOWATT220AC/TO-220FPAC).

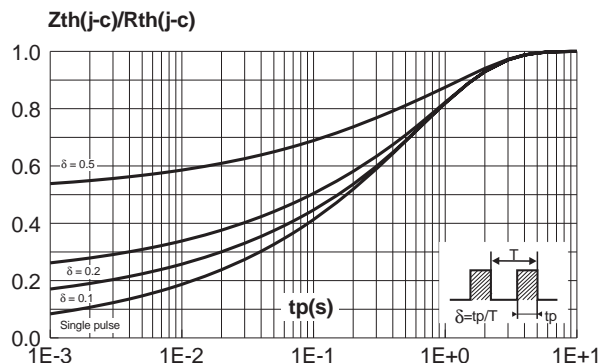

Fig. 7: Reverse leakage current versus reverse voltage applied (typical values).

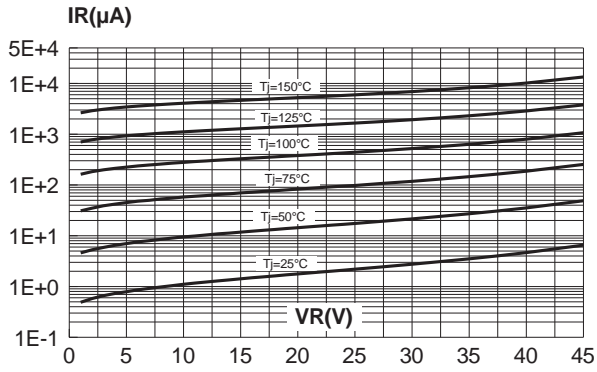

Fig. 8: Junction capacitance versus reverse voltage applied (typical values).

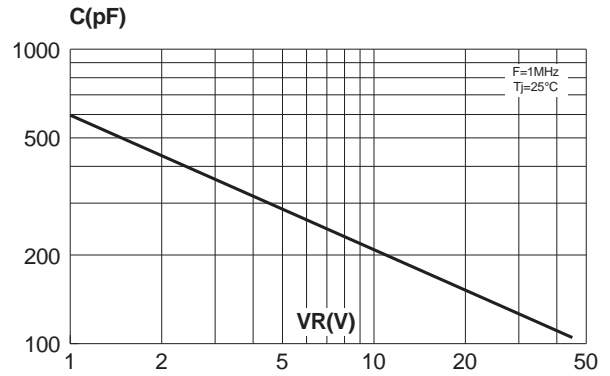

Fig. 9: Forward voltage drop versus forward current (maximum values).

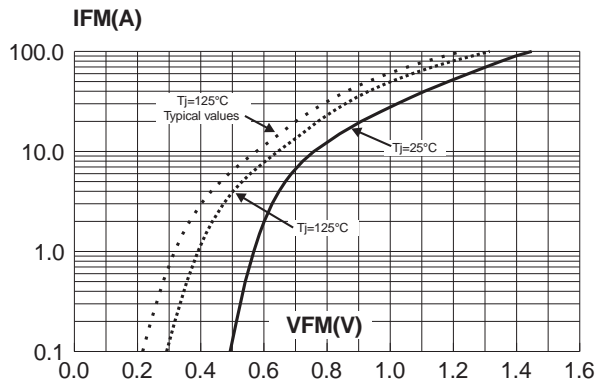
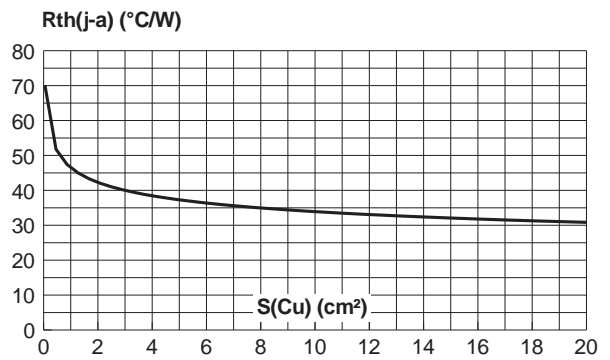
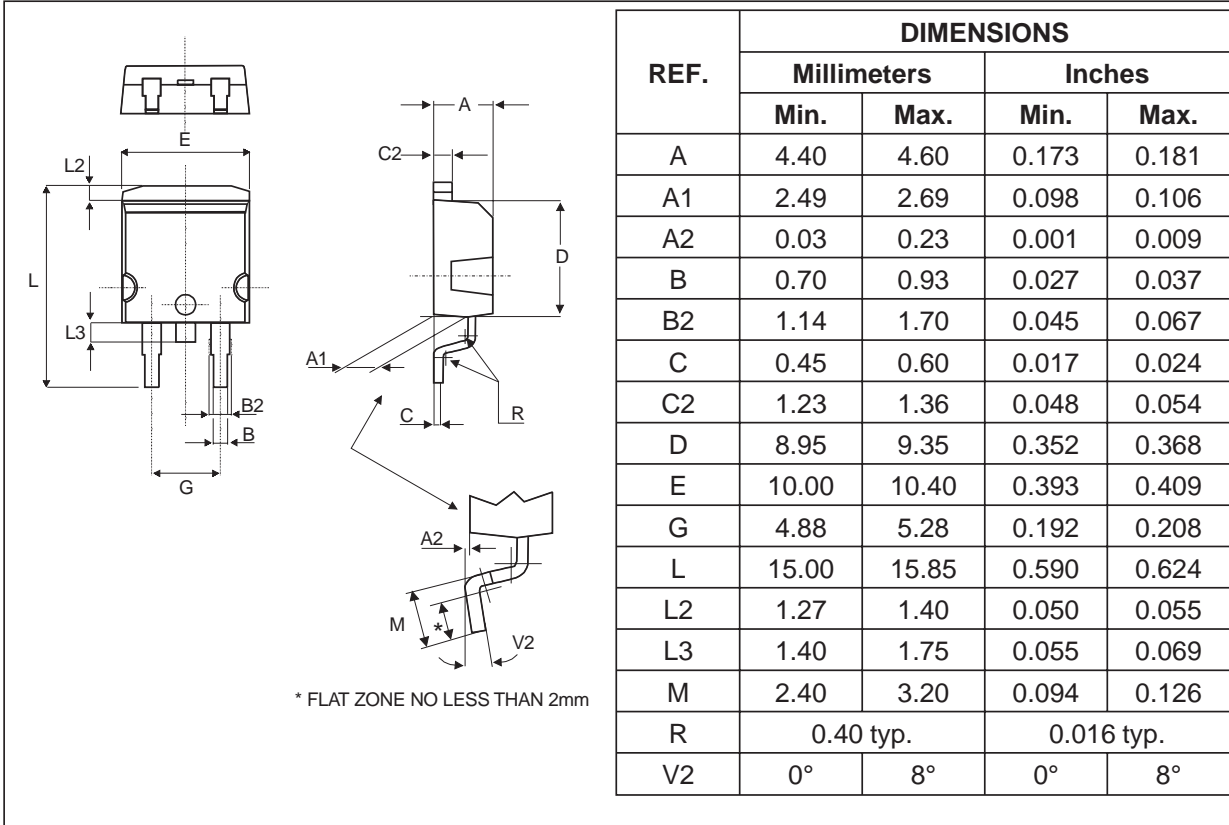

Fig. 10: Thermal resistance junction to ambient versus copper surface under tab (Epoxy printed circuit board, copper thickness: $35\mu m$).



PACKAGE MECHANICAL DATA
D²PAK (Plastic)



FOOTPRINT DIMENSIONS (in millimeters)

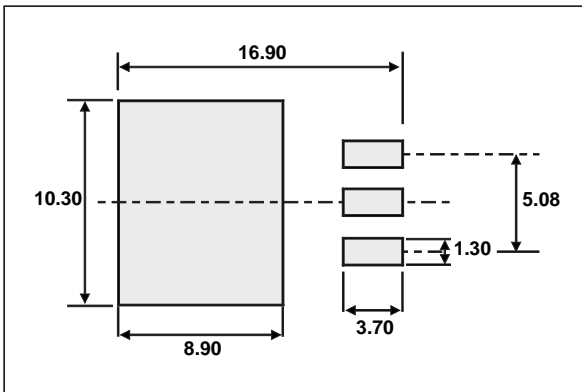

STPS745D/F/G/FP

PACKAGE MECHANICAL DATA
TO-220FPAC

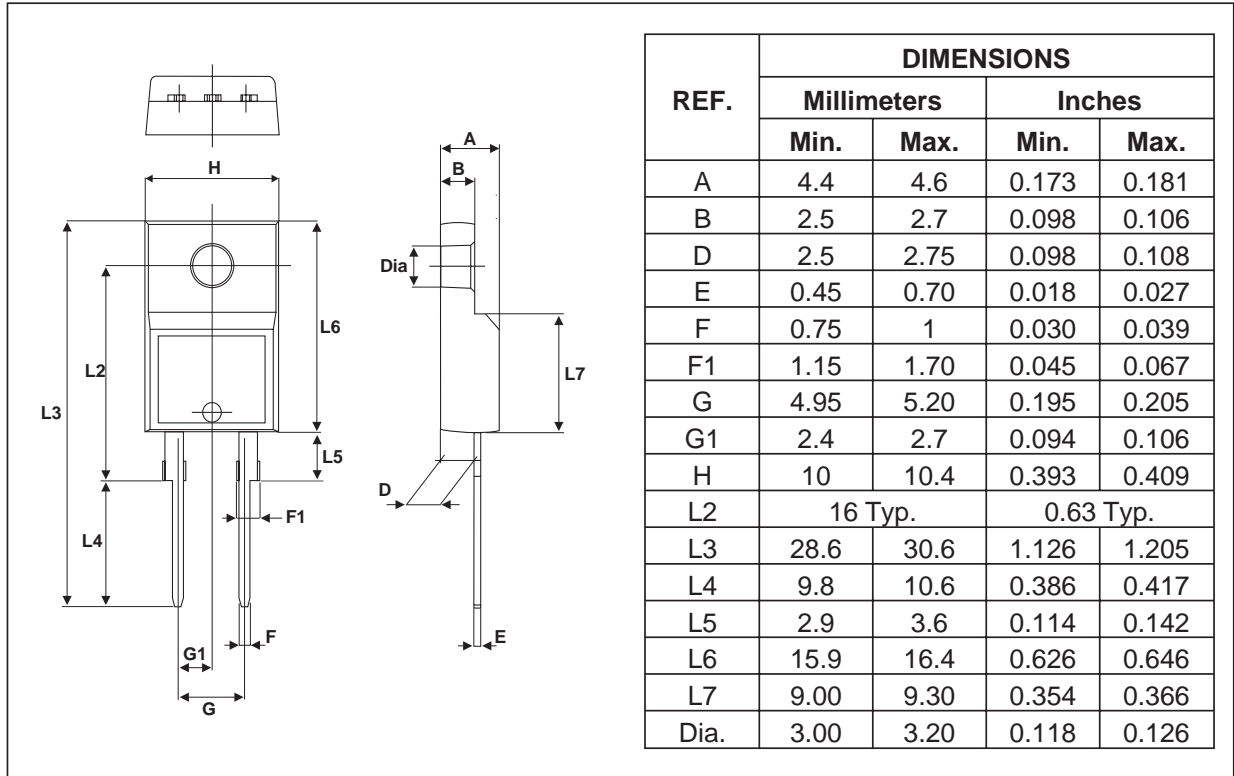

PACKAGE MECHANICAL DATA
TO-220AC

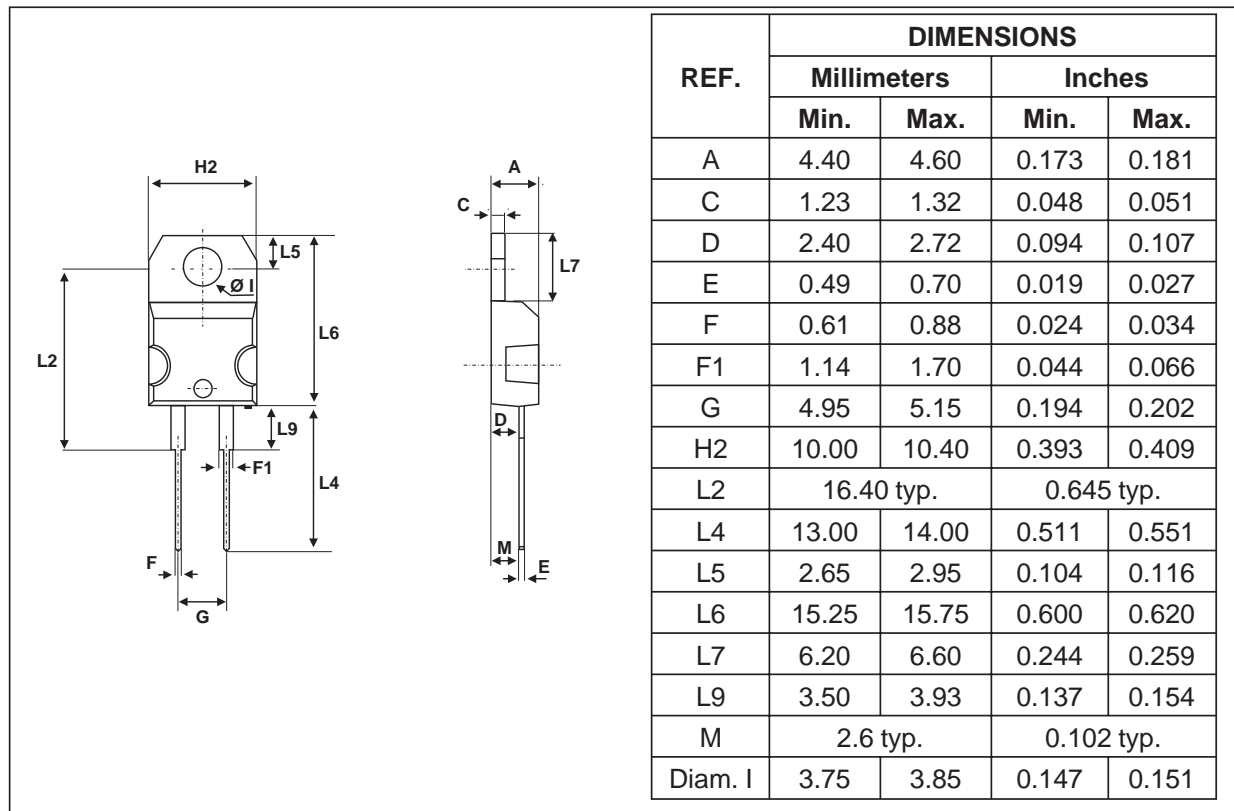

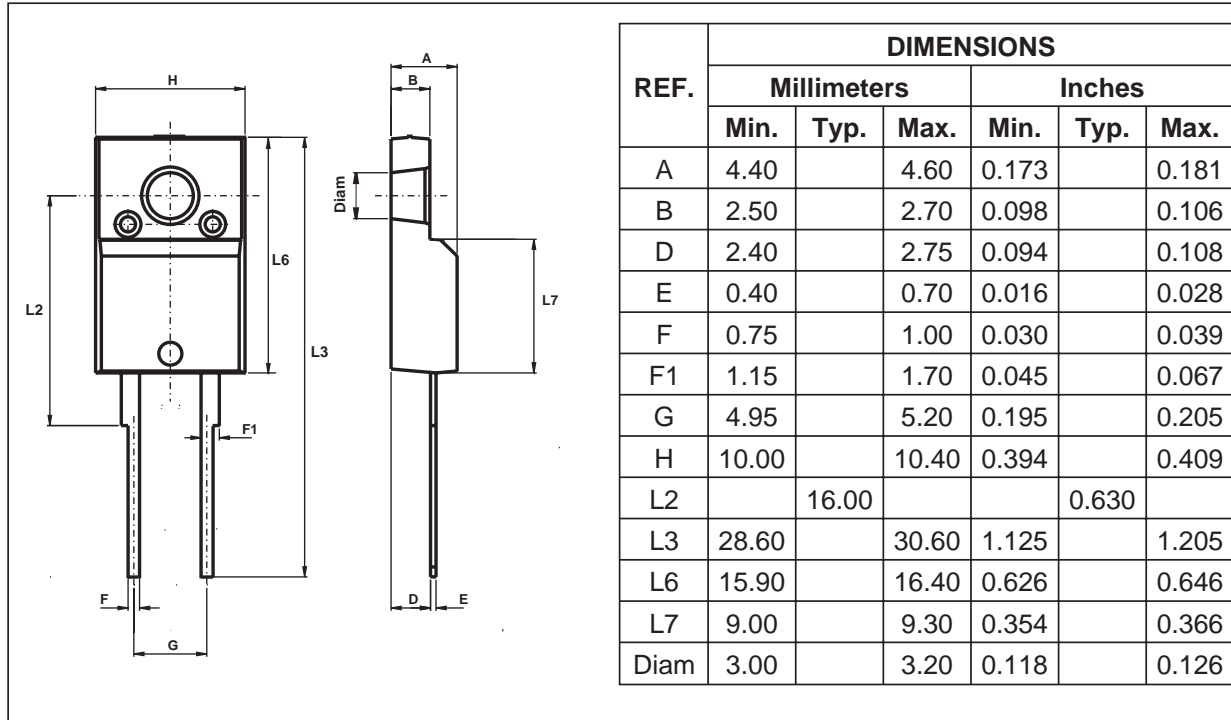
PACKAGE MECHANICAL DATA
 ISOWATT220AC

Type	Marking	Package	Weight	Base qty	Delivery mode
STPS745D	STPS745D	TO-220AC	1.86 g.	50	Tube
STPS745F	STPS745F	ISOWATT220AC	2 g.	50	Tube
STPS745G	STPS745G	D ² PAK	1.48 g.	50	Tube
STPS745G-TR	STPS745G	D ² PAK	1.48 g.	1000	Tape & reel
STPS745FP	STPS745FP	TO-220FPAC	1.9 g.	50	Tube

- Cooling method: by conduction (C)
- Recommended torque value: 0.55 N.m
- Maximum torque value: 0.7 N.m.
- Epoxy meets UL94,V0

Information furnished is believed to be accurate and reliable. However, STMicroelectronics assumes no responsibility for the consequences of use of such information nor for any infringement of patents or other rights of third parties which may result from its use. No license is granted by implication or otherwise under any patent or patent rights of STMicroelectronics. Specifications mentioned in this publication are subject to change without notice. This publication supersedes and replaces all information previously supplied.

STMicroelectronics products are not authorized for use as critical components in life support devices or systems without express written approval of STMicroelectronics.

The ST logo is a registered trademark of STMicroelectronics

© 2003 STMicroelectronics - Printed in Italy - All rights reserved.

STMicroelectronics GROUP OF COMPANIES

Australia - Brazil - Canada - China - Finland - France - Germany
 Hong Kong - India - Israel - Italy - Japan - Malaysia - Malta - Morocco - Singapore
 Spain - Sweden - Switzerland - United Kingdom - United States.

<http://www.st.com>