



Application Specific Discretes
A.S.D.™

ESDAxxSC5 ESDAxxSC6

QUAD TRANSIL ARRAY FOR ESD PROTECTION

APPLICATIONS

Where transient overvoltage protection in ESD sensitive equipment is required, such as :

- Computers
- Printers
- Communication systems
- Cellular phone handsets and accessories
- Other telephone set
- Set top boxes

FEATURES

- 4 Unidirectional Transil™ Functions
- Low leakage current: $I_R \text{ max.} < 20 \mu\text{A}$ at V_{BR}
- 500 W Peak pulse power (8/20 μs)

DESCRIPTION

The ESDAxxSC5 and ESDAxxSC6 are monolithic voltage suppressors designed to protect components which are connected to data and transmission lines against ESD.

They clamp the voltage just above the logic level supply for positive transients, and to a diode drop below ground for negative transient.

BENEFITS

- High ESD protection level : up to 25 kV
- High integration
- Suitable for high density boards

COMPLIES WITH THE FOLLOWING STANDARDS:

IEC61000-4-2 : level 4

- 15kV (air discharge)
- 8kV (contact discharge)

MIL STD 883E-Method 3015-7 : class3B
(human body model)

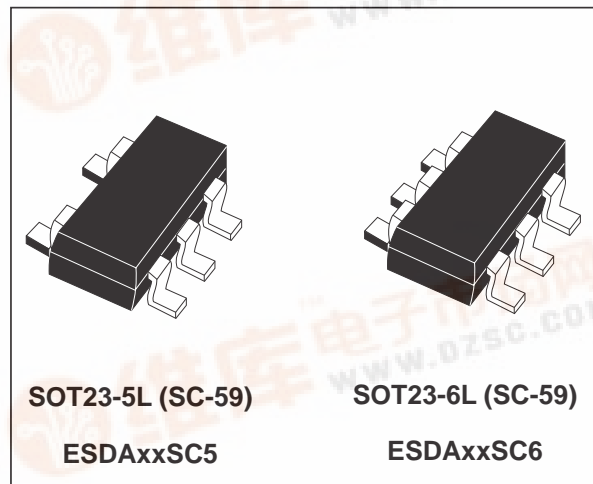

FUNCTIONAL DIAGRAM SOT23-5L

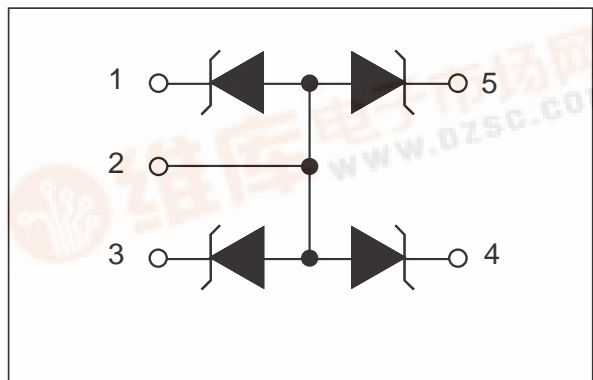

SOT23-6L

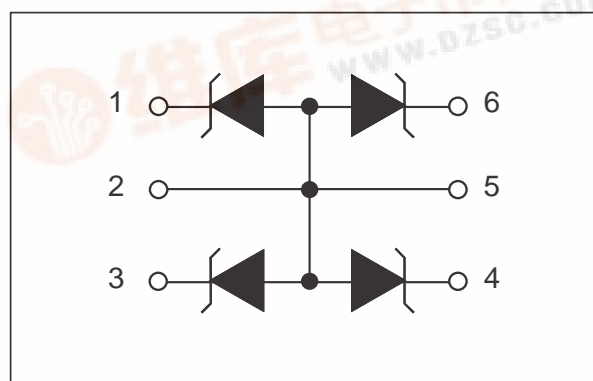

ESDAxxSC5 / ESDAxxSC6

ABSOLUTE MAXIMUM RATINGS ($T_{amb} = 25^{\circ}\text{C}$)

Symbol	Test conditions	Value	Unit
V_{PP}	ESD discharge - MIL STD 883E - Method 3015-7 IEC61000-4-2 air discharge IEC61000-4-2 contact discharge	25	kV
P_{PP}	Peak pulse power (8/20 μs) note1	ESDA5V3SCx ESDA6V1SCx	500 W
		ESDA14V2SCx ESDA17SC6 ESDA19SC6 ESDA25SC6	300 W
T_j	Junction temperature	150	$^{\circ}\text{C}$
T_{stg}	Storage temperature range	-55 to +150	$^{\circ}\text{C}$
T_L	Lead solder temperature (10 second duration)	260	$^{\circ}\text{C}$
T_{op}	Operating temperature range	-40 to +125	$^{\circ}\text{C}$

ELECTRICAL CHARACTERISTICS ($T_{amb} = 25^{\circ}\text{C}$)

Symbol	Parameter
V_{RM}	Stand-off voltage
V_{BR}	Breakdown voltage
V_{CL}	Clamping voltage
I_{RM}	Leakage current
I_{PP}	Peak pulse current
αT	Voltage temperature coefficient
C	Capacitance
R_d	Dynamic resistance
V_F	Forward voltage drop

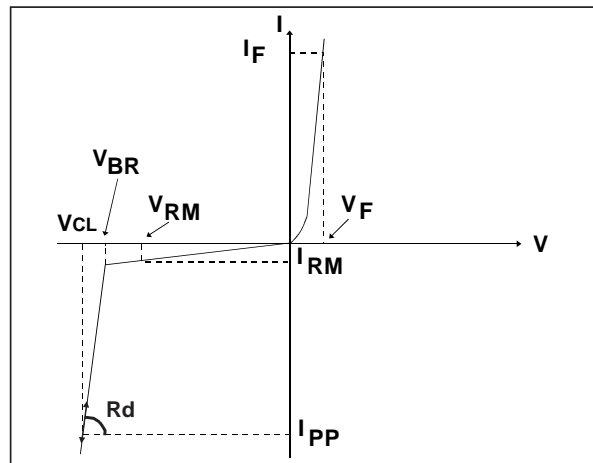

Types	V _{BR} @ I _R		I _{RM} @ V _{RM}		R _d typ. note 1	αT max. note 2	C typ. 0V bias	V _F @ I _F		
	min.	max.	max.					max.		
	V	V	mA	μA	V	mΩ	10 ⁻⁴ /°C	pF	V	mA
ESDA5V3SC5 ESDA5V3SC6	5.3	5.9	1	2	3	230	5	280	1.25	200
ESDA6V1SC5 ESDA6V1SC6	6.1	7.2	1	20	5.25	350	6	190	1.25	200
ESDA14V2SC5 ESDA14V2SC6	14.2	15.8	1	5	12	650	10	100	1.25	200
ESDA17SC6 ESDA19SC6	17 19	19 21	1 1	0.075 0.1	14 15	700 800	10 8.5	85 80	1.2 1.2	10 10
ESDA25SC6	25	30	1	1	24	1000	10	60	1.2	10

note 1 : Square pulse, I_{pp} = 15A, t_p = 2.5μs.

note 2 : ΔV_{BR} = αT * (T_{amb} - 25°C) * V_{BR} (25°C)

**CALCULATION OF THE CLAMPING VOLTAGE
USE OF THE DYNAMIC RESISTANCE**

The ESDA family has been designed to clamp fast spikes like ESD. Generally the PCB designers need to calculate easily the clamping voltage V_{CL}. This is why we give the dynamic resistance in addition to the classical parameters. The voltage across the protection cell can be calculated with the following formula:

$$V_{CL} = V_{BR} + R_d I_{pp}$$

Where I_{pp} is the peak current through the ESDA cell.

As the value of the dynamic resistance remains stable for a surge duration lower than 20μs, the 2.5μs rectangular surge is well adapted. In addition both rise and fall times are optimized to avoid any parasitic phenomenon during the measurement of R_d.

DYNAMIC RESISTANCE MEASUREMENT

The short duration of the ESD has led us to prefer a more adapted test wave, as below defined, to the classical 8/20μs and 10/1000μs surges.

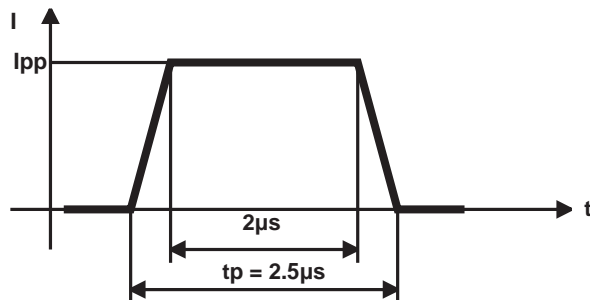

2.5μs duration measurement wave.

ESDAxxSC5 / ESDAxxSC6

Fig. 1: Peak power dissipation versus initial junction temperature.

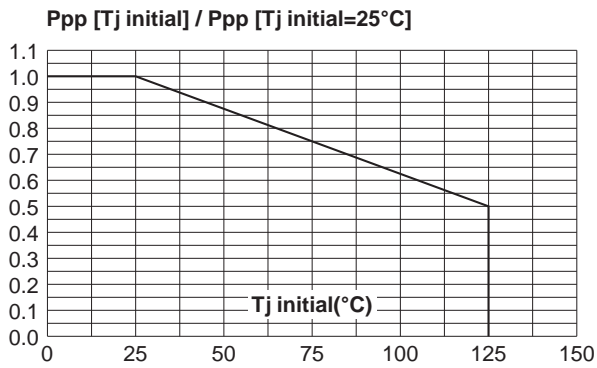

Fig. 2: Peak pulse power versus exponential pulse duration ($T_j \text{ initial} = 25^\circ\text{C}$).

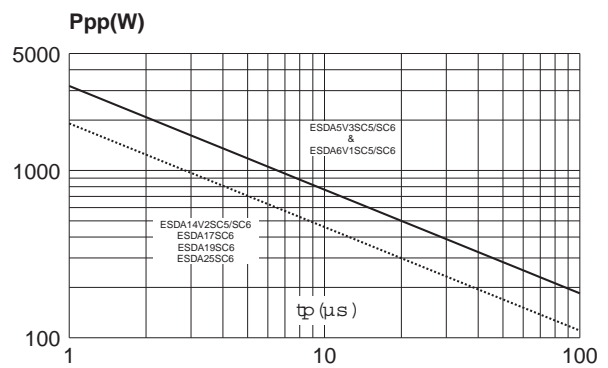

Fig. 3: Clamping voltage versus peak pulse current ($T_j \text{ initial} = 25^\circ\text{C}$). Rectangular waveform ($t_p = 2.5 \mu\text{s}$).

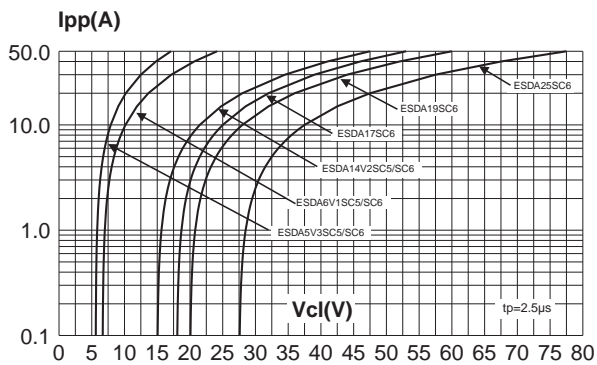

Fig. 4: Capacitance versus reverse applied voltage (typical values).

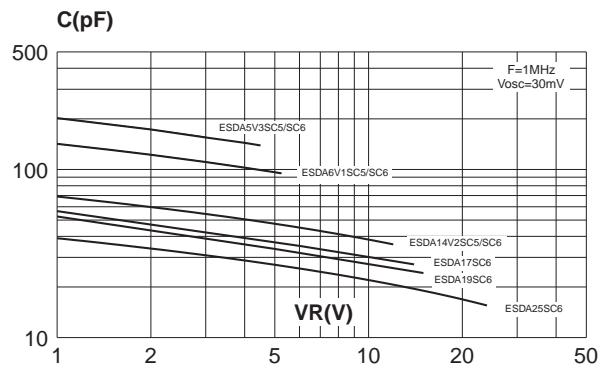

Fig. 5: Relative variation of leakage current versus junction temperature (typical values).

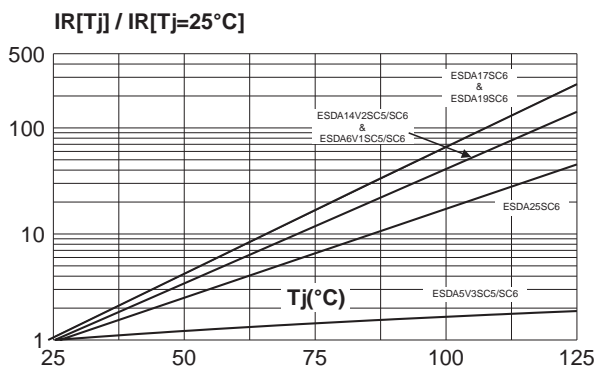
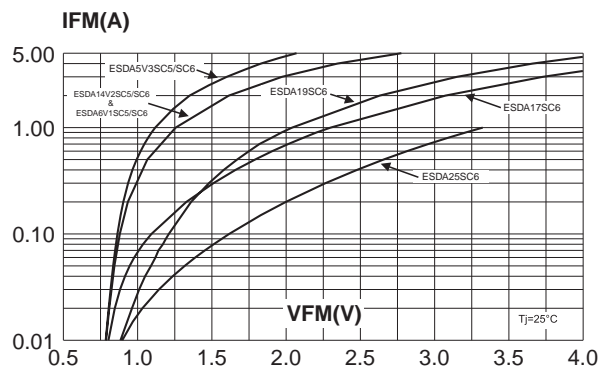

Fig. 6: Peak forward voltage drop versus peak forward current (typical values).



ESD protection by ESDAXXXSCX

Electrostatic discharge (ESD) is a major cause of failure in electronic systems.

Transient Voltage Suppressors (TVS) are an ideal choice for ESD protection. They are capable of clamping the incoming transient overvoltage to a low enough level such that damage to the protected semiconductor is prevented.

They serve as parallel protection elements, connected between the signal line and ground. As the transient rises above the operating voltage of the device, the TVS array becomes a low impedance path diverting the transient current to ground.

Surface mount TVS arrays offer the best choice for minimal lead inductance.

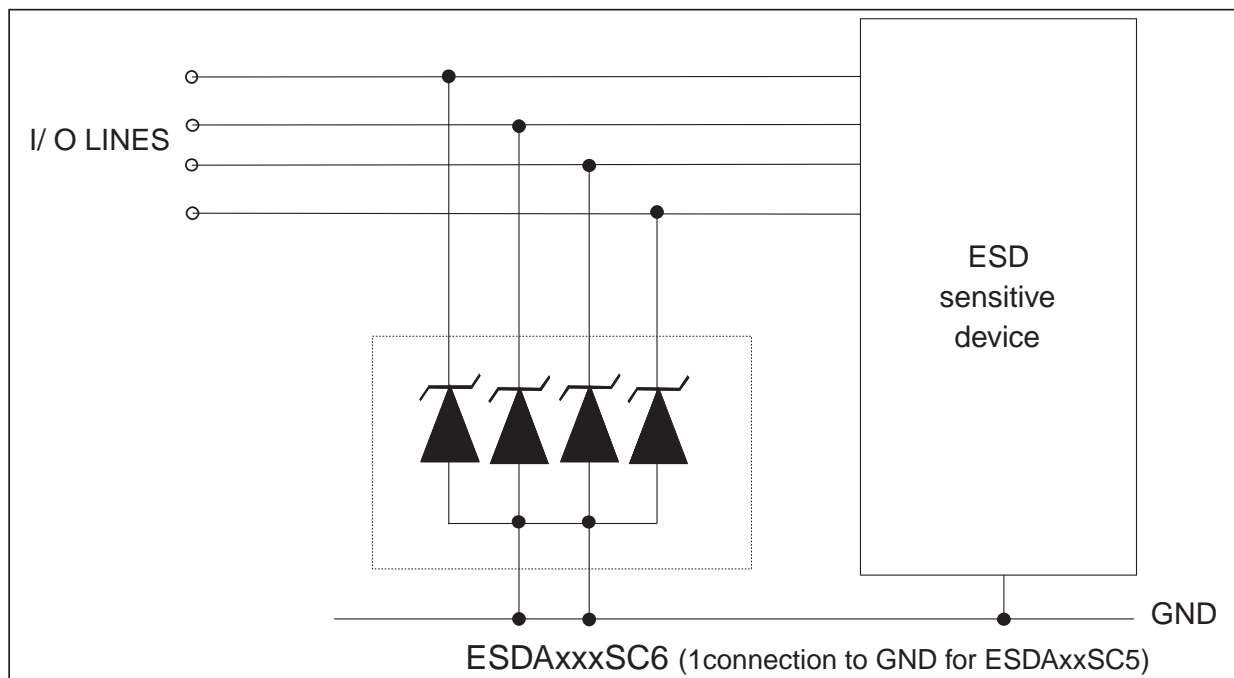

The ESDAxxSCx array is the ideal board level protection of ESD sensitive semiconductor components.

The tiny SOT23-5L and SOT23-6L packages allow design flexibility in the high density boards where the space saving is at a premium. This enables to shorten the routing and contributes to hardening against ESD.

ADVICE FOR OPTIMIZING CIRCUIT BOARD LAYOUT

Circuit board layout is a critical design step in the suppression of ESD induced transients. The following guidelines are recommended :

- The ESDAxxSC5/6 should be placed as close as possible to the input terminals or connectors.
- The path length between the ESD suppressor and the protected line should be minimized
- All conductive loops, including power and ground loops should be minimized
- The ESD transient return path to ground should be kept as short as possible.
- Ground planes should be used whenever possible.

ADVICE FOR OPTIMIZING CIRCUIT BOARD LAYOUT

Circuit board layout is a critical design step in the suppression of ESD induced transients. The following guidelines are recommended:

- The ESDA19SC6 should be placed as close as possible to the input terminals or connectors.
- The path length between the ESD suppressor and the protected line should be minimized.
- All conductive loops, including power and ground loops should be minimized.
- The ESD transient return path to ground should be kept as short as possible.
- Ground planes should be used whenever possible.

TECHNICAL INFORMATION

ESD PROTECTION

The **ESDA19SC6** is particularly optimized to perform ESD protection. ESD protection is achieved by clamping the unwanted overvoltage. The clamping voltage is given by the following formula :

$$V_{CL} = V_{BR} + R_d \cdot I_{pp}$$

As shown in figure A1, the ESD strikes are clamped by the transient voltage suppressor.

Fig. A1: ESD clamping behavior (example)

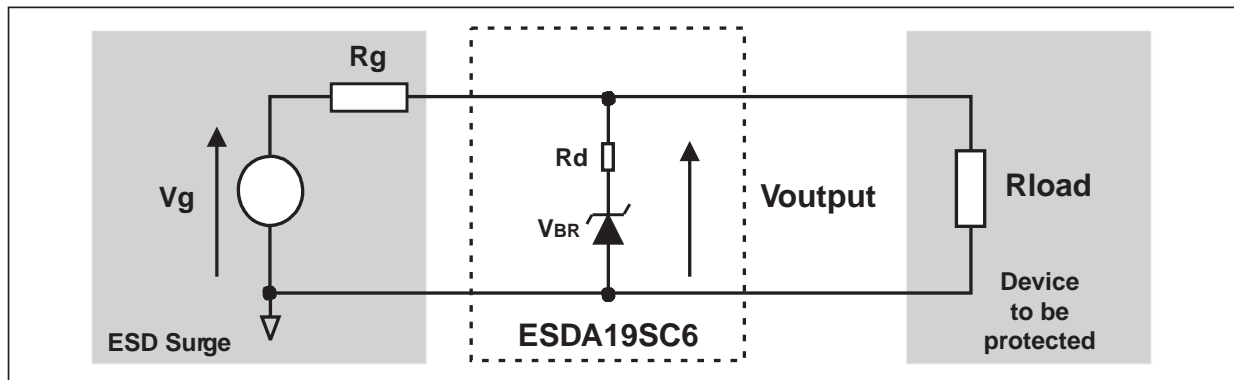

To have a good approximation of the remaining voltages at both VI/O side, we provide the typical dynamical resistance value Rd. By taking into account the following hypothesis :

$$R_g > R_d \text{ and } R_{load} > R_d$$

we have:

$$V_{Output} = V_{BR} + R_d \times \frac{V_g}{R_g}$$

The results of the calculation done for Vg = 8 kV, Rg = 330 Ω (IEC61000-4-2 standard), Vbr = 19 V (typ.) and Rd = 0.80 Ω (typ.) give:

$$V_{Output} = 38.4 \text{ V}$$

This confirms the very low remaining voltage across the device to be protected. It is also important to note that in this approximation the parasitic inductance effect was not taken into account. This could be a few tenths of volts during a few nanoseconds at the output side.

ORDER CODE

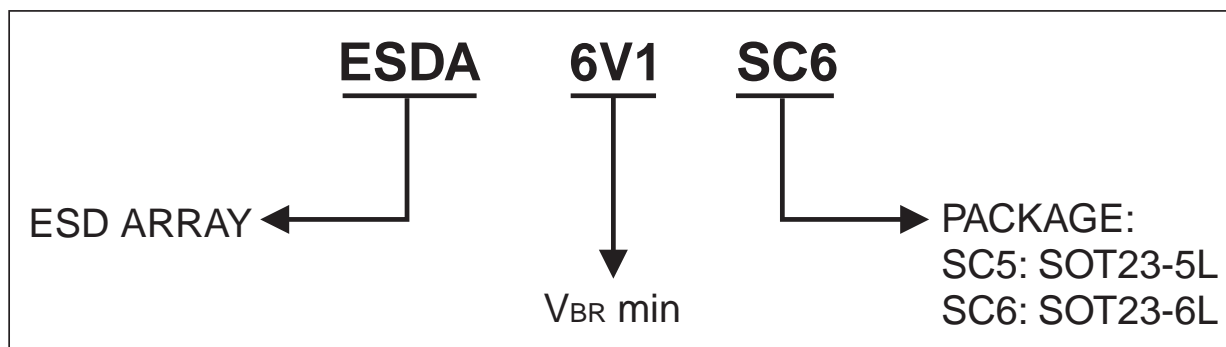

ORDERING INFORMATION

Odering Type	Marking	Package	Weight	Base qty	Delivery mode
ESDA5V3SC5	EC53	SOT23-5L	16.7 mg	3000	Tape & reel
ESDA5V3SC6	ES53	SOT23-6L	16.7 mg	3000	Tape & reel
ESDA6V1SC5	EC61	SOT23-5L	16.7 mg	3000	Tape & reel
ESDA6V1SC6	ES61	SOT23-6L	16.7 mg	3000	Tape & reel
ESDA14V2SC5	EC15	SOT23-5L	16.7 mg	3000	Tape & reel
ESDA14V2SC6	ES15	SOT23-6L	16.7 mg	3000	Tape & reel
ESDA17SC6	ES17	SOT23-6L	16.7 mg	3000	Tape & reel
ESDA19SC6	ES19	SOT23-6L	16.7 mg	3000	Tape & reel
ESDA25SC6	ES25	SOT23-6L	16.7 mg	3000	Tape & reel

- Epoxy meets UL94-V0 standard

ESDAxxSC5 / ESDAxxSC6

PACKAGE MECHANICAL DATA
SOT23-5L

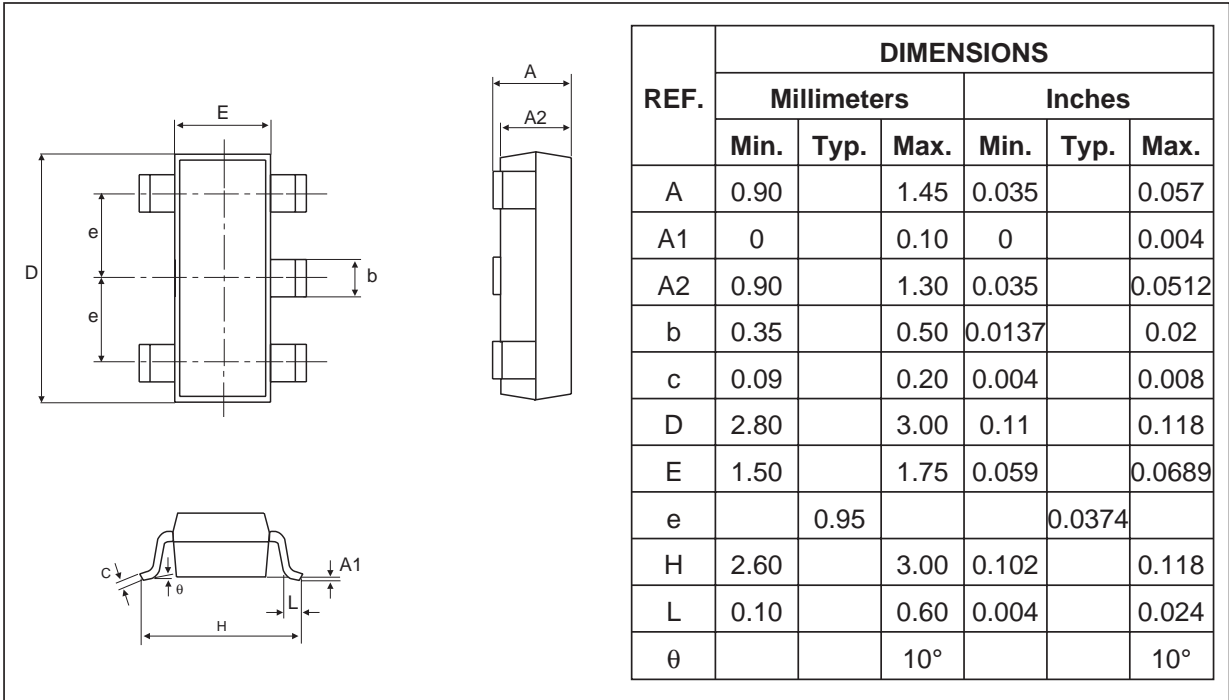

FOOT PRINT

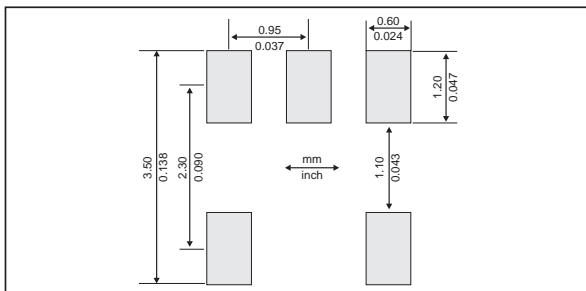

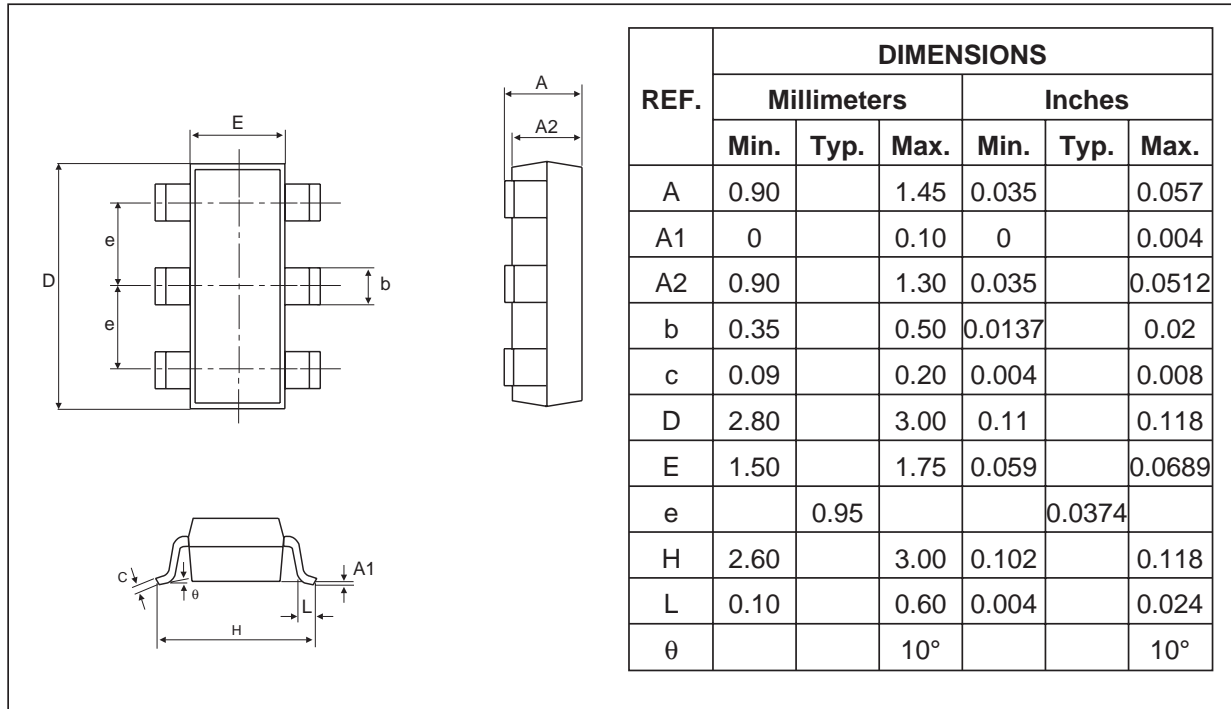
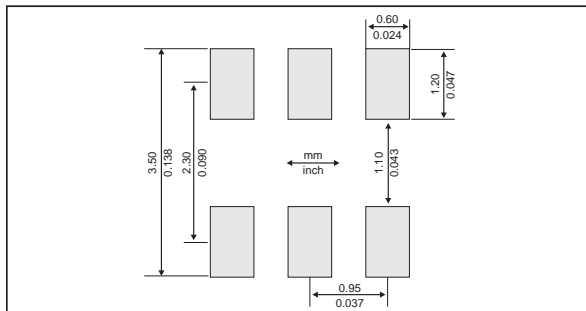
PACKAGE MECHANICAL DATA
 SOT23-6L

FOOT PRINT

Information furnished is believed to be accurate and reliable. However, STMicroelectronics assumes no responsibility for the consequences of use of such information nor for any infringement of patents or other rights of third parties which may result from its use. No license is granted by implication or otherwise under any patent or patent rights of STMicroelectronics. Specifications mentioned in this publication are subject to change without notice. This publication supersedes and replaces all information previously supplied.

STMicroelectronics products are not authorized for use as critical components in life support devices or systems without express written approval of STMicroelectronics.

The ST logo is a registered trademark of STMicroelectronics

© 2002 STMicroelectronics - Printed in Italy - All rights reserved.

STMicroelectronics GROUP OF COMPANIES

Australia - Brazil - Canada - China - Finland - France - Germany
 Hong Kong - India - Israel - Italy - Japan - Malaysia - Malta - Morocco - Singapore
 Spain - Sweden - Switzerland - United Kingdom - United States.

<http://www.st.com>