



CMOS 4/8 Channel Analog Multiplexers

AD7501/AD7502/AD7503

FEATURES

- DTL/TTL/CMOS Direct Interface
- Power Dissipation: 30 μ W
- R_{ON}: 170 Ω
- Standard 16-Pin DIPs and 20-Terminal Surface Mount Packages

GENERAL DESCRIPTION

The AD7501 and AD7503 are monolithic CMOS, 8-channel analog multiplexers which switches one of 8 inputs to a common output depending on the state of three binary address lines and an "enable" input. The AD7503 is identical to the AD7501 except its "enable" logic is inverted. All digital inputs are TTL/DTL and CMOS logic compatible.

The AD7502 is a monolithic CMOS dual 4-channel analog multiplexer. Depending on the state of 2 binary address inputs and an "enable", it switches two output buses to two of 8 inputs.

FUNCTIONAL BLOCK DIAGRAMS

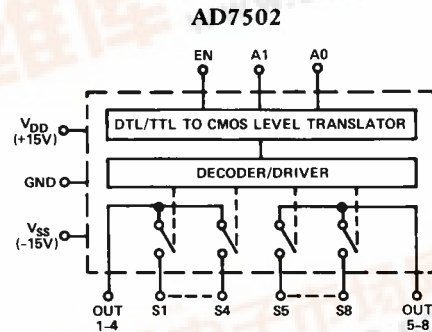
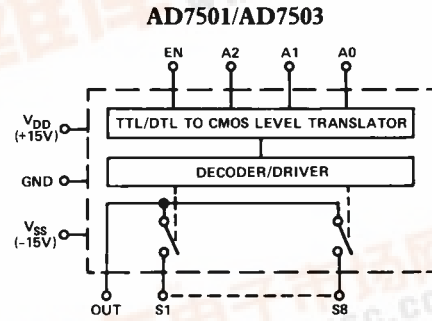

TRUTH TABLES

AD7501				
A ₂	A ₁	A ₀	E _N	"ON"
0	0	0	1	1
0	0	1	1	2
0	1	0	1	3
0	1	1	1	4
1	0	0	1	5
1	0	1	1	6
1	1	0	1	7
1	1	1	1	8
X	X	X	0	None

AD7503				
A ₂	A ₁	A ₀	E _N	"ON"
0	0	0	0	1
0	0	1	0	2
0	1	0	0	3
0	1	1	0	4
1	0	0	0	5
1	0	1	0	6
1	1	0	0	7
1	1	1	0	8
X	X	X	1	None

AD7502			
A ₁	A ₀	E _N	"ON"
0	0	1	1 & 5
0	1	1	2 & 6
1	0	1	3 & 7
1	1	1	4 & 8
X	X	0	None

REV. A

Information furnished by Analog Devices is believed to be accurate and reliable. However, no responsibility is assumed by Analog Devices for its use, nor for any infringements of patents or other rights of third parties which may result from its use. No license is granted by implication or otherwise under any patent or patent rights of Analog Devices.

AD7501/AD7502/AD7503—SPECIFICATIONS ($V_{DD} = +15V$, $V_{SS} = -15V$ unless otherwise noted.)

PARAMETER	VERSION ¹	SWITCH CONDITION	@25°C		OVER SPECIFIED TEMP. RANGE		TEST CONDITIONS
			AD7501, AD7503	AD7502	AD7501, AD7503	AD7502	
ANALOG SWITCH							
R_{ON}	All	ON	170Ω typ, 300Ω max	*			$-10V \leq V_S \leq +10V$
R_{ON} vs. V_S	All	ON	20% typ	*			$I_S = 1.0mA$
R_{ON} vs. Temperature	All	ON	0.5%/°C typ	*			$V_S = 0V$, $I_S = 1.0mA$
ΔR_{ON} Between Switches	All	ON	4% typ	*			
R_{ON} vs. Temperature Between Switches	All	ON	±0.01%/°C	*			
I_S	K	OFF	0.2nA typ, 2nA max	*	50nA max	*	$V_S = -10V$, $V_{OUT} = +10V$ and
	S	OFF	0.5nA max	*	50nA max	*	$V_S = +10V$, $V_{OUT} = -10V$
I_{OUT}	K	OFF	1nA typ, 10nA max	0.6nA typ, 5nA max	250nA max	125nA max	$V_S = -10V$, $V_{OUT} = +10V$ and
	S	OFF	5nA max	3nA max	250nA max	125nA max	$V_S = +10V$, $V_{OUT} = -10V$
							AD7501/02: Enable LOW
							AD7503: Enable HIGH
$ I_{OUT} - I_S $	K	ON	12nA max	7nA max	300nA max	175nA max	$V_S = 0$
	S	ON	5.5nA max	3.5nA max	300nA max	175nA max	
DIGITAL CONTROL							
V_{INL}	All				0.8V max	*	
V_{INH}	All				2.4V min	*	
I_{INL} or I_{INH}	All		10nA typ	*			
C_{IN}	All		3pF typ	*			
DYNAMIC CHARACTERISTICS							
t_{ON}	All		0.8μs typ	*			$V_{IN} = 0$ to +5.0V
t_{OFF}	All		0.8μs typ	*			(See Test Circuit 2)
C_S	All	OFF	5pF typ	*			
C_{OUT}	All	OFF	30pF typ	15pF typ			
C_{S-OUT}	All	OFF	0.5pF typ	*			
C_{SS} Between Any Two Switches	All	OFF	0.5pF typ	*			
POWER SUPPLY							
I_{DD}	All		500μA max	*	500μA max	*	All Digital Inputs Low
I_{SS}	All		500μA max	*	500μA max	*	
I_{DD}	All		800μA max	*	800μA max	*	All Digital Inputs High
I_{SS}	All		800μA max	*	800μA max	*	

NOTES

*Same specifications as AD7501 and AD7503.

¹KN version specified for 0 to +70°C, KQ version for -25°C to +85°C; and SQ, SE versions for -55°C to +125°C.

Specifications subject to change without notice.

ABSOLUTE MAXIMUM RATINGS*

($T_A = +25^\circ C$ unless otherwise noted)

V_{DD} to GND	+17V
V_{SS} to GND	-17V
V Between Any Switch Terminals (see Note 1)	25V
Digital Input Voltage Range	V_{DD} to GND
Overvoltage at V_{OUT} (V_S)	V_{SS} , V_{DD}
Switch Current (I_S , Continuous One Channel)	35mA
Switch Current (I_S , Surge One Channel)	
1ms Duration, 10% Duty Cycle	50mA
Power Dissipation (Any Package)	
Up to +75°C	450mW
Derates above +75°C by	6mW/°C

Operating Temperature

Commercial (KN Version)	0 to +70°C
Industrial (KQ Version)	-25°C to +85°C
Extended (SQ, SE Versions)	-55°C to +125°C
Storage Temperature	-65°C to +150°C
Lead Temperature (Soldering, 10sec)	+300°C

CAUTION

- Do not apply voltages higher than V_{DD} and V_{SS} to any other terminal, especially when $V_{SS} = V_{DD} = 0V$ all other pins should be at 0V.
- The digital control inputs are diode protected; however, permanent damage may occur on unconnected units under high energy electrostatic fields. Keep unused units in conductive foam at all times.

CAUTION:

ESD (electrostatic discharge) sensitive device. The digital control inputs are diode protected; however, permanent damage may occur on unconnected devices subject to high energy electrostatic fields. Unused devices must be stored in conductive foam or shunts. The protective foam should be discharged to the destination socket before devices are inserted.



AD7501/AD7502/AD7503

ORDERING GUIDE

Model ¹	Temperature Range	Package Option ²
AD7501KN	0°C to +70°C	N-16
AD7501KQ	-25°C to +85°C	Q-16
AD7501SQ	-55°C to +125°C	Q-16
AD7501SE	-55°C to +125°C	E-20A
AD7502KN	0°C to +70°C	N-16
AD7502KQ	-25°C to +85°C	Q-16
AD7502SQ	-55°C to +125°C	Q-16
AD7502SE	-55°C to +125°C	E-20A
AD7503KN	0°C to +70°C	N-16
AD7503KQ	-25°C to +85°C	Q-16
AD7503SQ	-55°C to +125°C	Q-16
AD7503SE	-55°C to +125°C	E-20A

NOTES

¹To order MIL-STD-883, Class B processed parts, add/883B to part number.

See the Analog Devices' 1990 Military Databook for military data sheet.

²E = Leadless Ceramic Chip Carrier; N = Narrow Plastic DIP; Q = Cerdip.

PIN CONFIGURATIONS

DIP

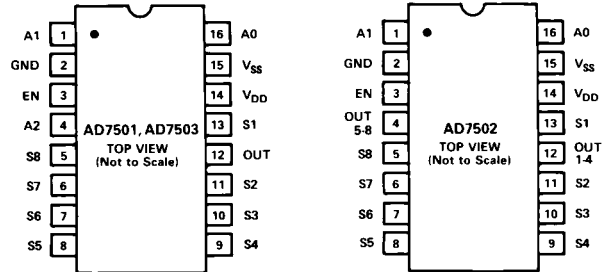

LCCC

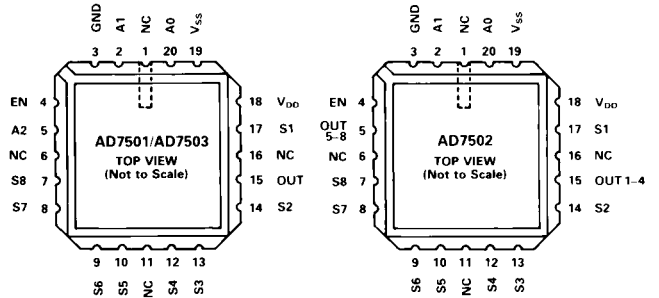

NC = NO CONNECT

Typical Performance Characteristics

1. R_{ON} Versus V_S

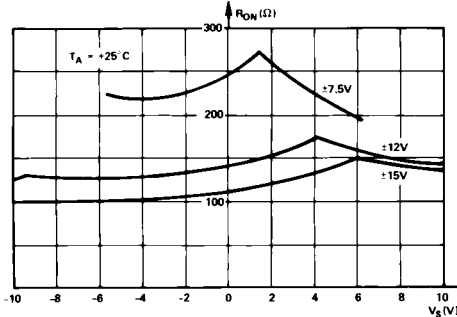

At Different Power Supplies

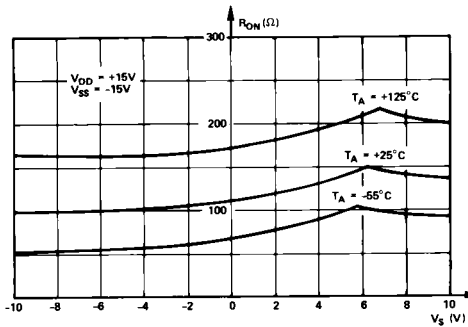

At Different Temperatures

2. Digital Threshold Voltage (V_{INH}, V_{NIL})

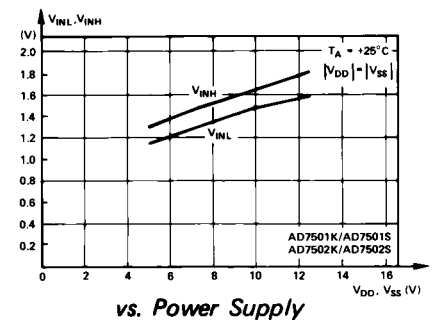

vs. Power Supply

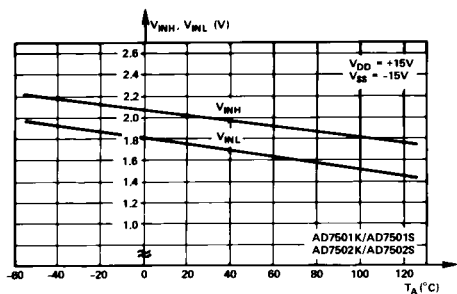

vs. Temperature

3. t_{ON}, t_{OFF}

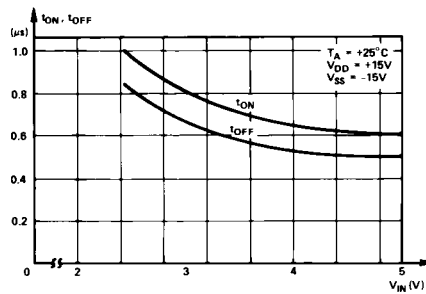

vs. Digital Input Voltage

4. Power Dissipation

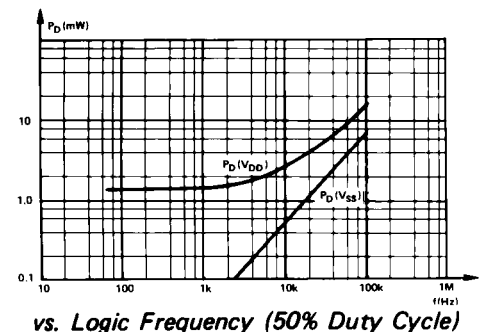

vs. Logic Frequency (50% Duty Cycle)

AD7501/AD7502/AD7503

TYPICAL SWITCHING CHARACTERISTICS

TEST CIRCUIT 1

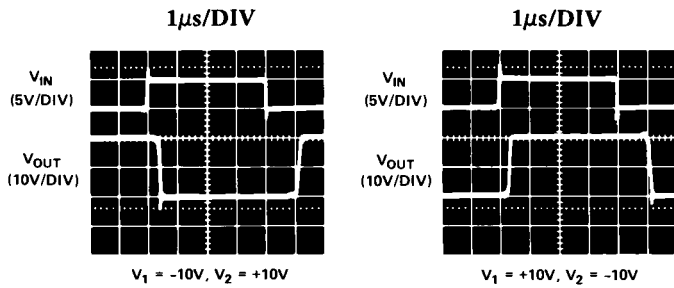
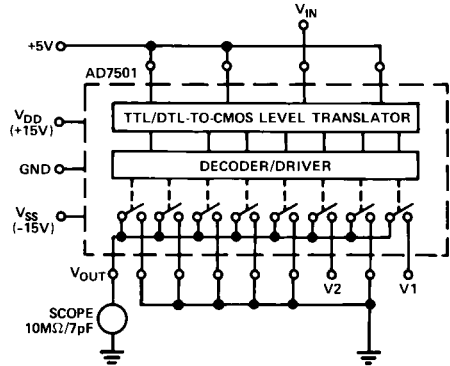

TEST CIRCUIT 2

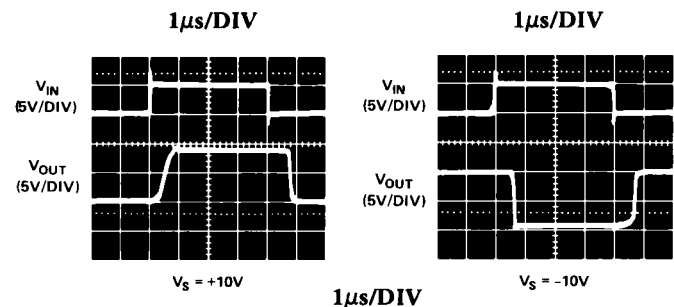
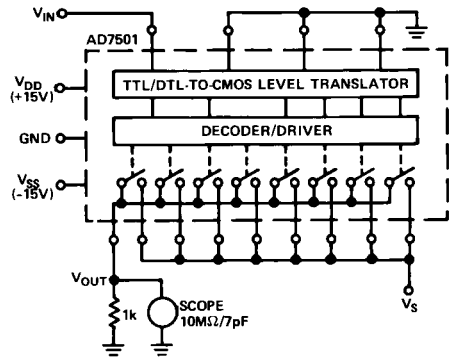

$V_S = +10V$ $1\mu s/DIV$ $V_S = -10V$

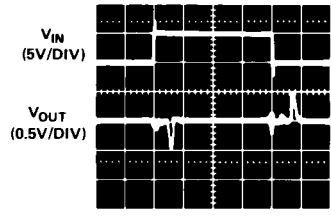

$V_S = OPEN$

OUTLINE DIMENSIONS

Dimensions shown in inches and (mm).

16-Pin Plastic DIP (N-16)

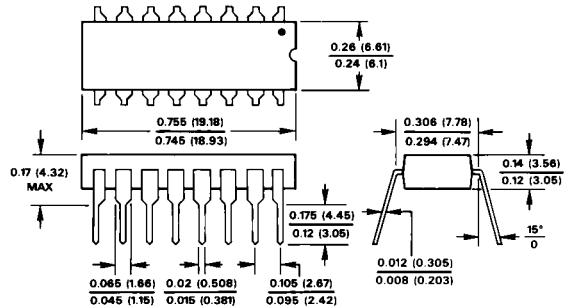

LEAD NO. 1 IDENTIFIED BY DOT OR NOTCH
LEADS ARE SOLDER OR TIN-PLATED KOVAR OR ALLOY 42

16-Pin Cerdip (Q-16)

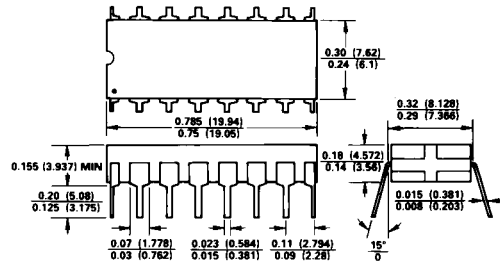

20-Terminal Leadless Ceramic Chip Carrier (E-20A)

