

## TLE207x, TLE207xA, TLE207xY EXCALIBUR LOW-NOISE HIGH-SPEED JFET-INPUT OPERATIONAL AMPLIFIERS

SLOS181A – FEBRUARY 1997 – REVISED MARCH 2000

- Direct Upgrades to TL05x, TL07x, and TL08x BiFET Operational Amplifiers
- Greater Than 2× Bandwidth (10 MHz) and 3× Slew Rate (45 V/μs) Than TL07x
- Ensured Maximum Noise Floor 17 nV/√Hz
- On-Chip Offset Voltage Trimming for Improved DC Performance
- Wider Supply Rails Increase Dynamic Signal Range to ±19 V

### description

The TLE207x series of JFET-input operational amplifiers more than double the bandwidth and triple the slew rate of the TL07x and TL08x families of BiFET operational amplifiers. Texas Instruments Excalibur process yields a typical noise floor of 11.6 nV/√Hz, 17-nV/√Hz ensured maximum, offering immediate improvement in noise-sensitive circuits designed using the TL07x. The TLE207x also has wider supply voltage rails, increasing the dynamic signal range for BiFET circuits to ±19 V. On-chip zener trimming of offset voltage yields precision grades for greater accuracy in dc-coupled applications. The TLE207x are pin-compatible with lower performance BiFET operational amplifiers for ease in improving performance in existing designs.

BiFET operational amplifiers offer the inherently higher input impedance of the JFET-input transistors, without sacrificing the output drive associated with bipolar amplifiers. This makes them better suited for interfacing with high-impedance sensors or very low-level ac signals. They also feature inherently better ac response than bipolar or CMOS devices having comparable power consumption.

The TLE207x family of BiFET amplifiers are Texas Instruments highest performance BiFETs, with tighter input offset voltage and ensured maximum noise specifications. Designers requiring less stringent specifications but seeking the improved ac characteristics of the TLE207x should consider the TLE208x operational amplifier family.

Because BiFET operational amplifiers are designed for use with dual power supplies, care must be taken to observe common-mode input voltage limits and output swing when operating from a single supply. DC biasing of the input signal is required and loads should be terminated to a virtual ground node at mid-supply. Texas Instruments TLE2426 integrated virtual ground generator is useful when operating BiFET amplifiers from single supplies.

The TLE207x are fully specified at ±15 V and ±5 V. For operation in low-voltage and/or single-supply systems, Texas Instruments LinCMOS families of operational amplifiers (TLC- and TLV-prefix) are recommended. When moving from BiFET to CMOS amplifiers, particular attention should be paid to slew rate and bandwidth requirements and output loading.

Please be aware that an important notice concerning availability, standard warranty, and use in critical applications of Texas Instruments semiconductor products and disclaimers thereto appears at the end of this data sheet.

# TLE207x, TLE207xA, TLE207xY EXCALIBUR LOW-NOISE HIGH-SPEED JFET-INPUT OPERATIONAL AMPLIFIERS

SLOS181A – FEBRUARY 1997 – REVISED MARCH 2000

## TLE2071 AVAILABLE OPTIONS

T <sub>A</sub>	V <sub>IO</sub> max AT 25°C	PACKAGED DEVICES				CHIP FORM‡ (Y)
		SMALL OUTLINE† (D)	CHIP CARRIER (FK)	CERAMIC DIP (JG)	PLASTIC DIP (P)	
0°C to 70°C	2 mV 4 mV	TLE2071ACD TLE2071CD	—	—	TLE2071ACP TLE2071CP	— TLE2071Y
–40°C to 85°C	2 mV 4 mV	TLE2071AID TLE2071ID	—	—	TLE2071AIP TLE2071IP	—
–55°C to 125°C	2 mV 4 mV	— —	TLE2071AMFK TLE2071MFK	TLE2071AMJG TLE2071MJG	— —	—

† The D packages are available taped and reeled. Add R suffix to device type (e.g., TLE2071ACDR).

‡ Chip-form versions are tested at T<sub>A</sub> = 25°C.

## TLE2072 AVAILABLE OPTIONS

T <sub>A</sub>	V <sub>IO</sub> max AT 25°C	PACKAGED DEVICES				CHIP FORM‡ (Y)
		SMALL OUTLINE† (D)	CHIP CARRIER (FK)	CERAMIC DIP (JG)	PLASTIC DIP (P)	
0°C to 70°C	3.5 mV 6 mV	TLE2072ACD TLE2072CD	—	—	TLE2072ACP TLE2072CP	— TLE2072Y
–40°C to 85°C	3.5 mV 6 mV	TLE2072AID TLE2072ID	—	—	TLE2072AIP TLE2072IP	—
–55°C to 125°C	3.5 mV 6 mV	—	TLE2072AMFK TLE2072MFK	TLE2072AMJG TLE2072MJG	—	—

† The D packages are available taped and reeled. Add R suffix to device type (e.g., TLE2072ACDR).

‡ Chip-form versions are tested at T<sub>A</sub> = 25°C.

## TLE2074 AVAILABLE OPTIONS

T <sub>A</sub>	V <sub>IO</sub> max AT 25°C	PACKAGED DEVICES				CHIP FORM‡ (Y)
		SMALL OUTLINE† (DW)	CHIP CARRIER (FK)	CERAMIC DIP (J)	PLASTIC DIP (N)	
0°C to 70°C	3 mV 5 mV	TLE2074ACDW TLE2074CDW	—	—	TLE2074ACN TLE2074CN	— TLE2074Y
–40°C to 85°C	3 mV 5 mV	TLE2074AIDW TLE2074IDW	—	—	TLE2074AIN TLE2074IN	—
–55°C to 125°C	3 mV 5 mV	—	TLE2074AMFK TLE2074MFK	TLE2074AMJ TLE2074MJ	—	—

† The DW packages are available taped and reeled. Add R suffix to device type (e.g., TLE2074ACDWR).

‡ Chip-form versions are tested at T<sub>A</sub> = 25°C.

# TLE207x, TLE207xA, TLE207xY EXCALIBUR LOW-NOISE HIGH-SPEED JFET-INPUT OPERATIONAL AMPLIFIERS

SLOS181A – FEBRUARY 1997 – REVISED MARCH 2000

**TLE2071 AND TLE2071A**  
D, JG, OR P PACKAGE  
(TOP VIEW)

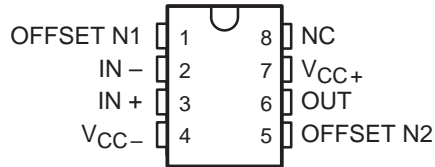

**TLE2072 AND TLE2072A**  
D, JG, OR P PACKAGE  
(TOP VIEW)

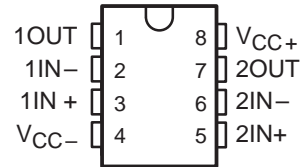

**TLE2074 AND TLE2074A**  
J OR N PACKAGE  
(TOP VIEW)

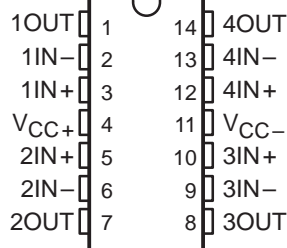

**TLE2074 AND TLE2074A**  
DW PACKAGE  
(TOP VIEW)

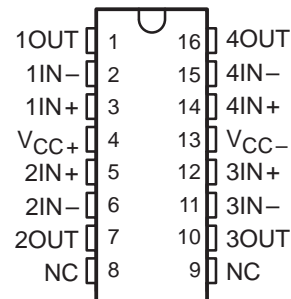

**TLE2071M AND TLE2071AM**  
FK PACKAGE  
(TOP VIEW)

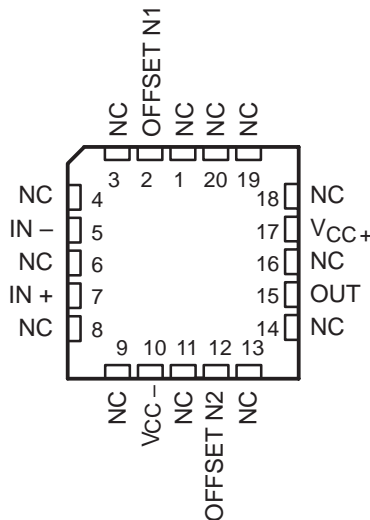

**TLE2072M AND TLE2072AM**  
FK PACKAGE  
(TOP VIEW)

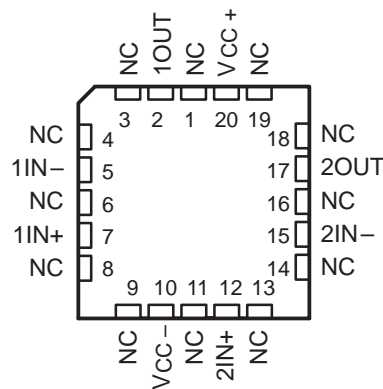

**TLE2074M AND TLE2074AM**  
FK PACKAGE  
(TOP VIEW)

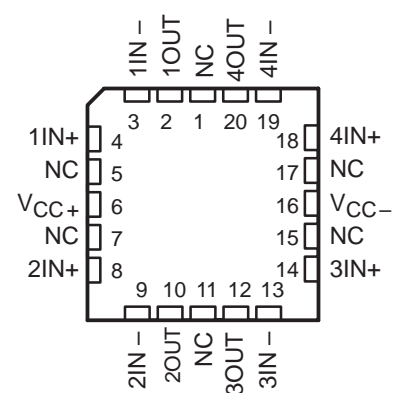

NC – No internal connection

## symbol

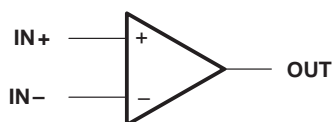

# TLE207x, TLE207xA, TLE207xY EXCALIBUR LOW-NOISE HIGH-SPEED JFET-INPUT OPERATIONAL AMPLIFIERS

SLOS181A – FEBRUARY 1997 – REVISED MARCH 2000

## TLE2071Y chip information

This chip, when properly assembled, displays characteristics similar to the TLE2071C. Thermal compression or ultrasonic bonding may be used on the doped-aluminum bonding pads. Chips may be mounted with conductive epoxy or a gold-silicon preform.

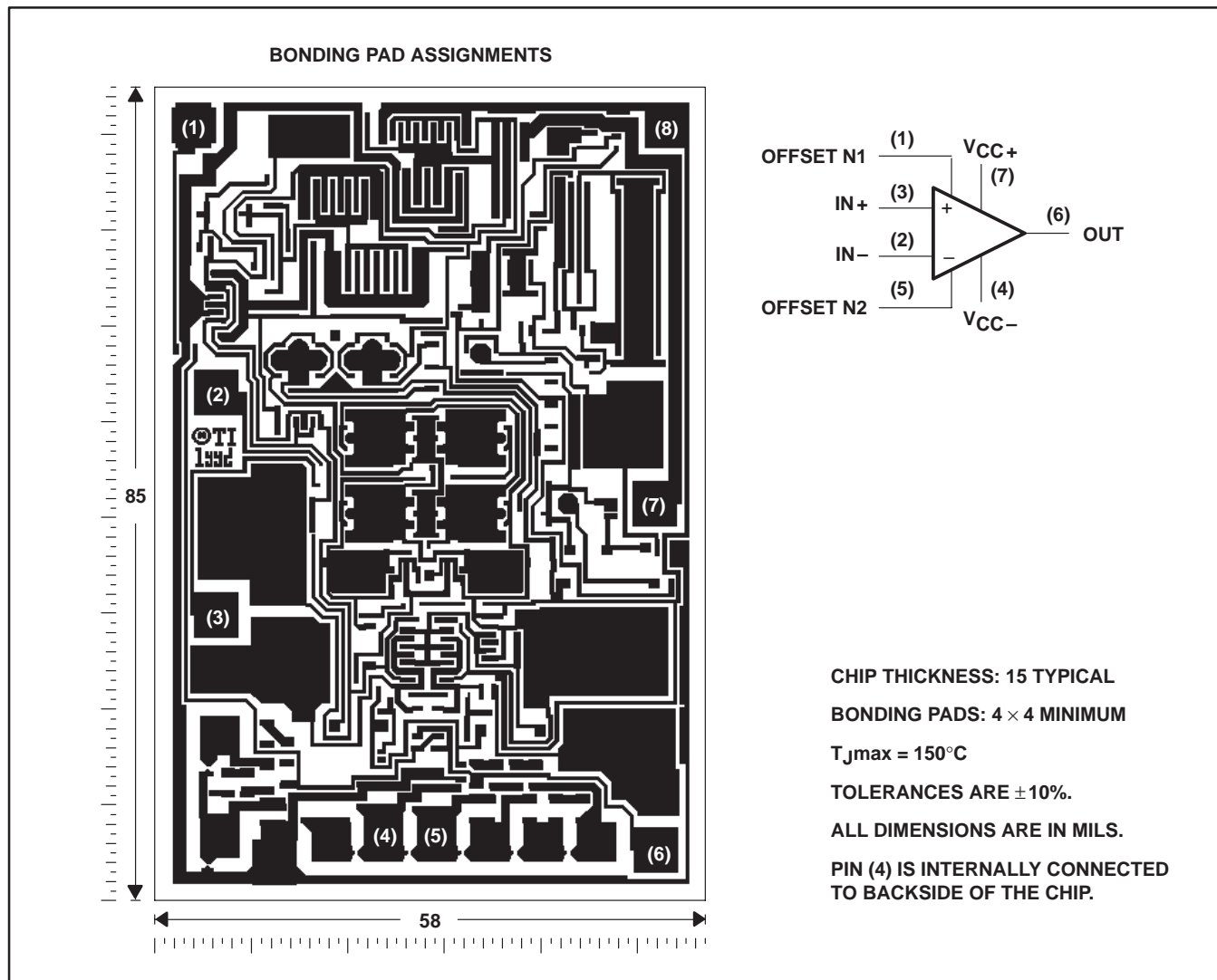

# TLE207x, TLE207xA, TLE207xY EXCALIBUR LOW-NOISE HIGH-SPEED JFET-INPUT OPERATIONAL AMPLIFIERS

SLOS181A – FEBRUARY 1997 – REVISED MARCH 2000

## TLE2072Y chip information

This chip, when properly assembled, displays characteristics similar to the TLE2072C. Thermal compression or ultrasonic bonding may be used on the doped-aluminum bonding pads. Chips may be mounted with conductive epoxy or a gold-silicon preform.

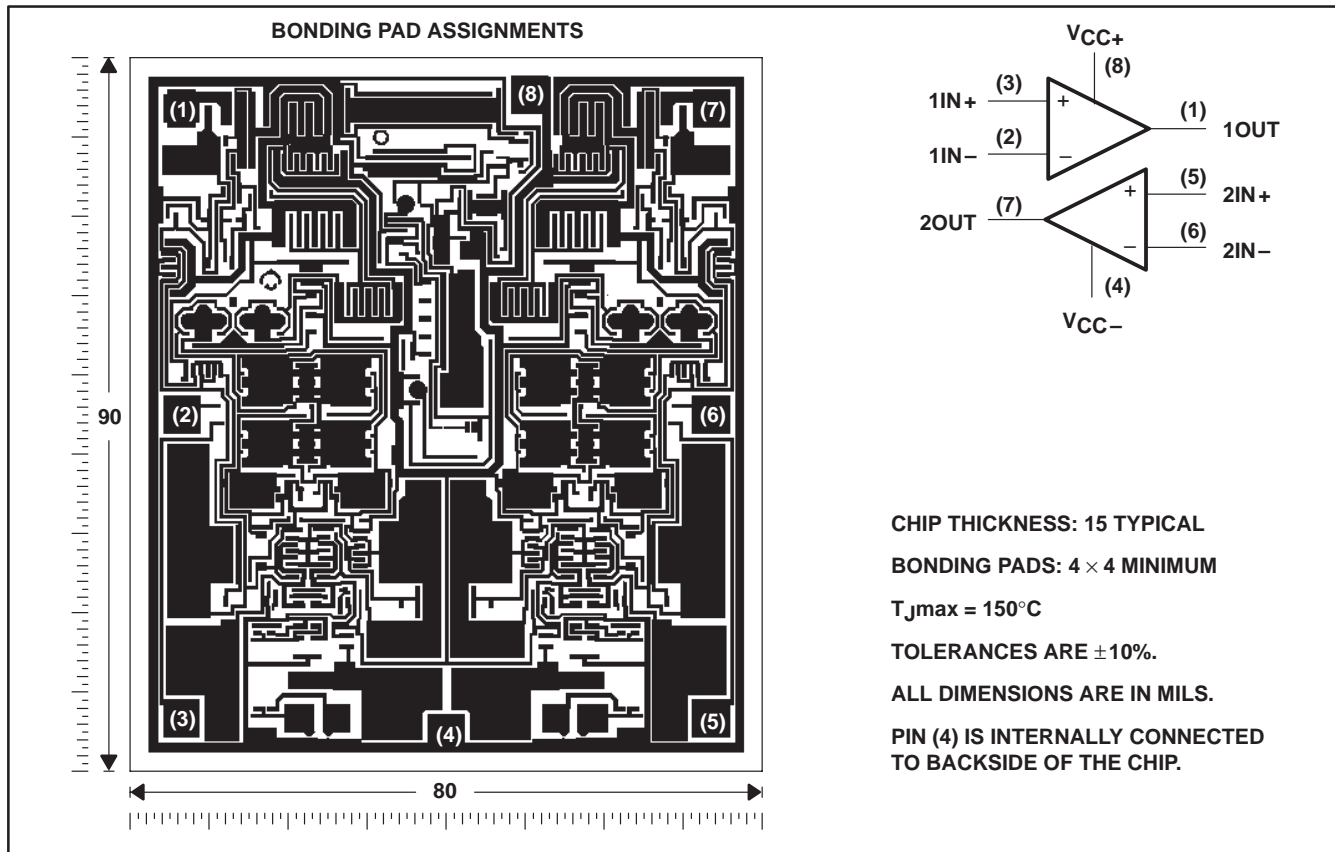

# TLE207x, TLE207xA, TLE207xY EXCALIBUR LOW-NOISE HIGH-SPEED JFET-INPUT OPERATIONAL AMPLIFIERS

SLOS181A – FEBRUARY 1997 – REVISED MARCH 2000

## TLE2074Y chip information

This chip, when properly assembled, displays characteristics similar to the TLE2074C. Thermal compression or ultrasonic bonding may be used on the doped-aluminum bonding pads. Chips may be mounted with conductive epoxy or a gold-silicon preform.

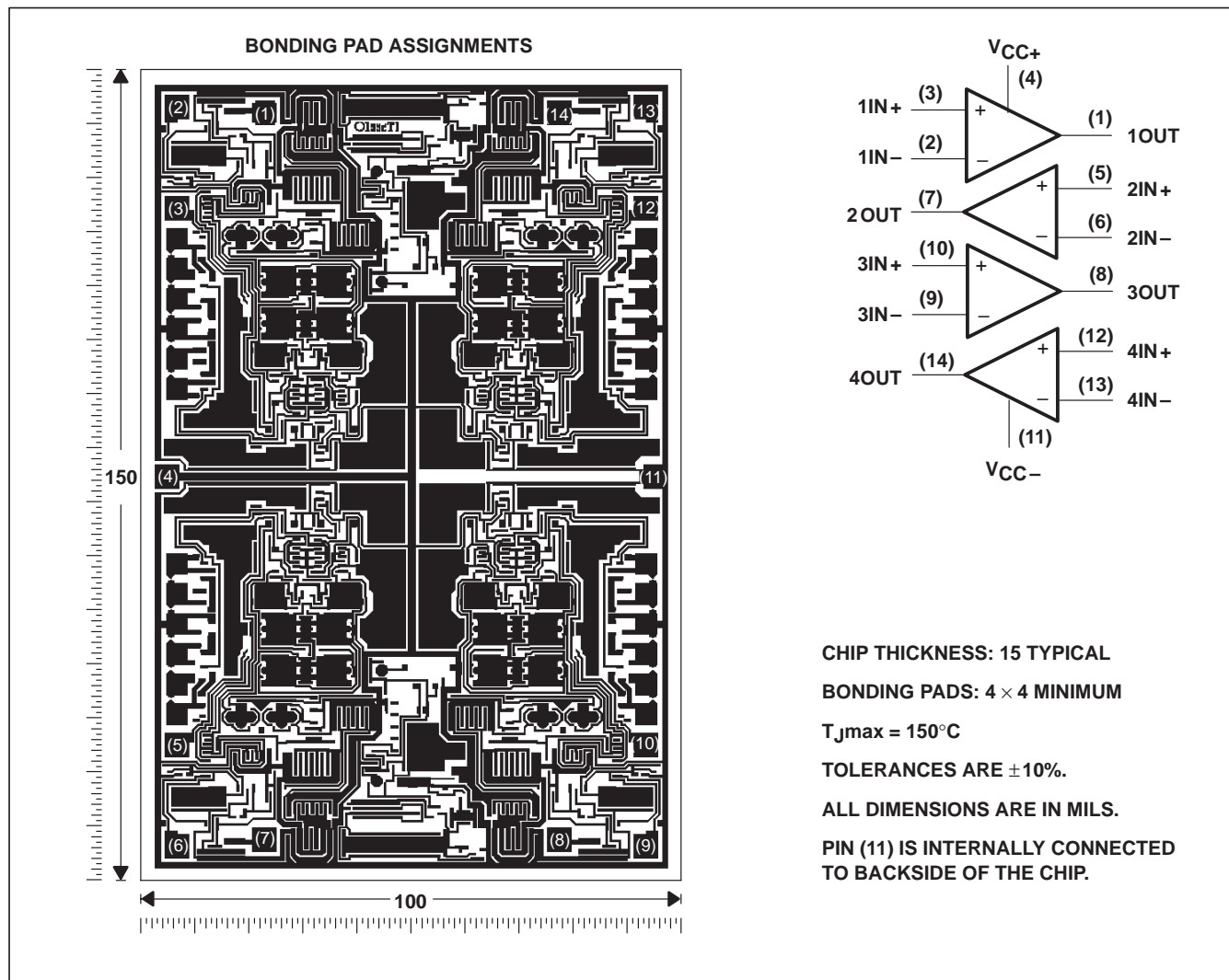

TLE207x, TLE207xA, TLE207xY  
 EXCALIBUR LOW-NOISE HIGH-SPEED  
 JFET-INPUT OPERATIONAL AMPLIFIERS  
 SLOS181A – FEBRUARY 1997 – REVISED MARCH 2000

equivalent schematic

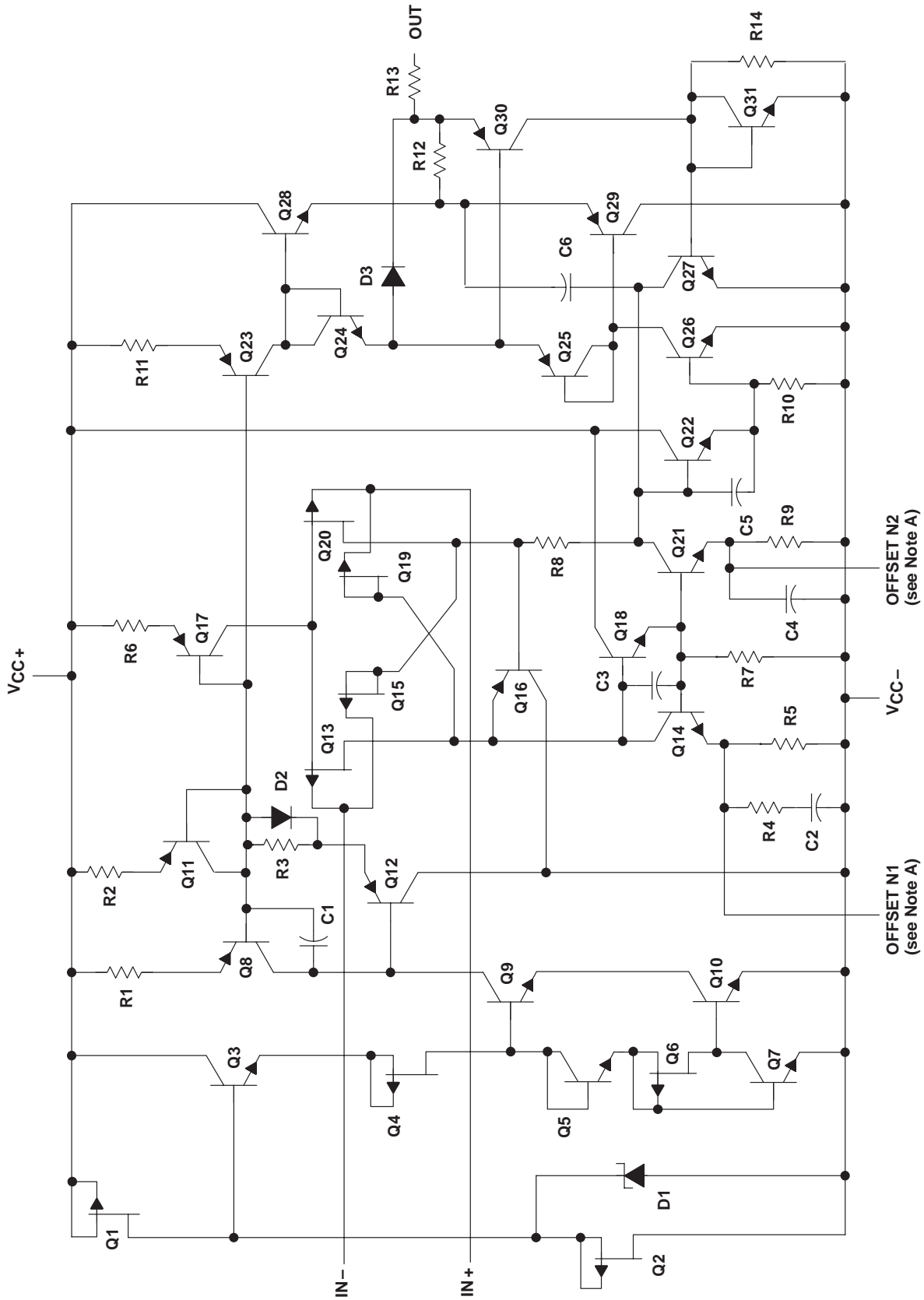

NOTES: A. OFFSET N1 AND OFFSET N2 are only available on the TLE2071x devices.

**TLE207x, TLE207xA, TLE207xY**  
**EXCALIBUR LOW-NOISE HIGH-SPEED**  
**JFET-INPUT OPERATIONAL AMPLIFIERS**  
SLOS181A – FEBRUARY 1997 – REVISED MARCH 2000

---

equivalent schematic (continued)

ACTUAL DEVICE COMPONENT COUNT			
COMPONENT	TLE2071	TLE2072	TLE2074
Transistors	33	57	114
Resistors	25	37	74
Diodes	8	5	10
Capacitors	6	11	22



**TLE207x, TLE207xA, TLE207xY**  
**EXCALIBUR LOW-NOISE HIGH-SPEED**  
**JFET-INPUT OPERATIONAL AMPLIFIERS**  
SLOS181A – FEBRUARY 1997 – REVISED MARCH 2000

**absolute maximum ratings over operating free-air temperature range (unless otherwise noted)†**

Supply voltage, $V_{CC+}$ (see Note 1)	19 V
Supply voltage, $V_{CC-}$ (see Note 1)	-19 V
Differential input voltage range, $V_{ID}$ (see Note 2)	$V_{CC+}$ to $V_{CC-}$
Input voltage range, $V_I$ (any input)	$V_{CC+}$ to $V_{CC-}$
Input current, $I_I$ (each input)	$\pm 1$ mA
Output current, $I_O$ (each output)	$\pm 80$ mA
Total current into $V_{CC+}$	160 mA
Total current out of $V_{CC-}$	160 mA
Duration of short-circuit current at (or below) 25°C (see Note 3)	unlimited
Continuous total dissipation	See Dissipation Rating Table
Operating free-air temperature range, $T_A$ : C suffix	0°C to 70°C
I suffix	-40°C to 85°C
M suffix	-55°C to 125°C
Storage temperature range	-65°C to 150°C
Case temperature for 60 seconds: FK package	260°C
Lead temperature 1,6 mm (1/16 inch) from case for 10 seconds: DW or N package	260°C
Lead temperature 1,6 mm (1/16 inch) from case for 60 seconds: J package	300°C

† Stresses beyond those listed under “absolute maximum ratings” may cause permanent damage to the device. These are stress ratings only, and functional operation of the device at these or any other conditions beyond those indicated under “recommended operating conditions” is not implied. Exposure to absolute-maximum-rated conditions for extended periods may affect device reliability.

- NOTES:
1. All voltage values, except differential voltages, are with respect to the midpoint between  $V_{CC+}$  and  $V_{CC-}$ .
  2. Differential voltages are at the noninverting input with respect to the inverting input.
  3. The output may be shorted to either supply. Temperatures and/or supply voltages must be limited to ensure that the maximum dissipation rate is not exceeded.

**DISSIPATION RATING TABLE**

PACKAGE	$T_A \leq 25^\circ\text{C}$	DERATING FACTOR ABOVE $T_A = 25^\circ\text{C}$	$T_A = 70^\circ\text{C}$	$T_A = 85^\circ\text{C}$	$T_A = 125^\circ\text{C}$
	POWER RATING		POWER RATING	POWER RATING	POWER RATING
D	725 mW	5.8 mW/°C	464 mW	377 mW	—
DW	1025 mW	8.2 mW/°C	656 mW	533 mW	205 mW
FK	1375 mW	11.0 mW/°C	880 mW	715 mW	275 mW
J	1375 mW	11.0 mW/°C	880 mW	715 mW	275 mW
JG	1050 mW	8.4 mW/°C	672 mW	546 mW	210 mW
N	1150 mW	9.2 mW/°C	736 mW	598 mW	230 mW
P	1000 mW	8.0 mW/°C	640 mW	344 mW	—

**recommended operating conditions**

	C SUFFIX		I SUFFIX		M SUFFIX		UNIT
	MIN	MAX	MIN	MAX	MIN	MAX	
Supply voltage, $V_{CC\pm}$	$\pm 2.25$	$\pm 19$	$\pm 2.25$	$\pm 19$	$\pm 2.25$	$\pm 19$	V
Common-mode input voltage, $V_{IC}$	$V_{CC\pm} = \pm 5$ V		-0.9	5	-0.8	5	V
	$V_{CC\pm} = \pm 15$ V		-10.9	15	-10.8	15	
Operating free-air temperature, $T_A$	0	70	-40	85	-55	125	°C

# TLE207x, TLE207xA, TLE207xY EXCALIBUR LOW-NOISE HIGH-SPEED JFET-INPUT OPERATIONAL AMPLIFIERS

SLOS181A – FEBRUARY 1997 – REVISED MARCH 2000

**TLE2071C electrical characteristics at specified free-air temperature,  $V_{CC\pm} = \pm 5$  V (unless otherwise noted)**

PARAMETER	TEST CONDITIONS	T <sub>A</sub> †	TLE2071C			TLE2071AC			UNIT	
			MIN	TYP	MAX	MIN	TYP	MAX		
V <sub>IO</sub> Input offset voltage	V <sub>IC</sub> = 0, V <sub>O</sub> = 0, R <sub>S</sub> = 50 Ω	25°C	0.34	4		0.3	2	mV		
		Full range			6		4			
α <sub>VIO</sub> Temperature coefficient of input offset voltage		Full range	3.2	29		3.2	29	μV/°C		
I <sub>IO</sub> Input offset current	V <sub>IC</sub> = 0, V <sub>O</sub> = 0, See Figure 4	25°C	5	100		5	100	pA		
		Full range			1.4		1.4	nA		
I <sub>IB</sub> Input bias current		25°C	15	175		15	175	pA		
		Full range			5		5	nA		
V <sub>ICR</sub> Common-mode input voltage range	R <sub>S</sub> = 50 Ω	25°C	5 to -1	5 to -1.9		5 to -1	5 to -1.9	V		
		Full range	5 to -0.9			5 to -0.9				
V <sub>OM+</sub> Maximum positive peak output voltage swing	I <sub>O</sub> = -200 μA	25°C	3.8	4.1		3.8	4.1	V		
		Full range	3.7			3.7				
	I <sub>O</sub> = -2 mA	25°C	3.5	3.9		3.5	3.9			
		Full range	3.4			3.4				
	I <sub>O</sub> = -20 mA	25°C	1.5	2.3		1.5	2.3			
		Full range	1.5			1.5				
V <sub>OM-</sub> Maximum negative peak output voltage swing	I <sub>O</sub> = 200 μA	25°C	-3.5	-4.2		-3.5	-4.2	V		
		Full range	-3.4			-3.4				
	I <sub>O</sub> = 2 mA	25°C	-3.7	-4.1		-3.7	-4.1			
		Full range	-3.6			-3.6				
	I <sub>O</sub> = 20 mA	25°C	-1.5	-2.4		-1.5	-2.4			
		Full range	-1.5			-1.5				
A <sub>VD</sub> Large-signal differential voltage amplification	V <sub>O</sub> = ± 2.3 V	R <sub>L</sub> = 600 Ω	25°C	80	91		80	91	dB	
			Full range	79			79			
		R <sub>L</sub> = 2 kΩ	25°C	90	100		90	100		
			Full range	89			89			
		R <sub>L</sub> = 10 kΩ	25°C	95	106		95	106		
			Full range	94			94			
r <sub>i</sub> Input resistance	V <sub>IC</sub> = 0	25°C	10 <sup>12</sup>			10 <sup>12</sup>			Ω	
c <sub>i</sub> Input capacitance	V <sub>IC</sub> = 0, See Figure 5	Common mode	25°C	11			11			pF
		Differential	25°C	2.5			2.5			
z <sub>o</sub> Open-loop output impedance	f = 1 MHz	25°C	80			80			Ω	
CMRR Common-mode rejection ratio	V <sub>IC</sub> = V <sub>ICRmin</sub> , V <sub>O</sub> = 0, R <sub>S</sub> = 50 Ω	25°C	70	89		70	89	dB		
		Full range	68			68				
k <sub>SVR</sub> Supply-voltage rejection ratio (ΔV <sub>CC±</sub> / ΔV <sub>IO</sub> )	V <sub>CC±</sub> = ±5 V to ±15 V, V <sub>O</sub> = 0, R <sub>S</sub> = 50 Ω	25°C	82	99		82	99	dB		
		Full range	80			80				

† Full range is 0°C to 70°C.

**TLE207x, TLE207xA, TLE207xY**  
**EXCALIBUR LOW-NOISE HIGH-SPEED**  
**JFET-INPUT OPERATIONAL AMPLIFIERS**  
 SLOS181A – FEBRUARY 1997 – REVISED MARCH 2000

**TLE2071C electrical characteristics at specified free-air temperature,  $V_{CC\pm} = \pm 5\text{ V}$  (unless otherwise noted) (continued)**

PARAMETER	TEST CONDITIONS	$T_A$ †	TLE2071C			TLE2071AC			UNIT
			MIN	TYP	MAX	MIN	TYP	MAX	
$I_{CC}$ Supply current	$V_O = 0$ , No load	25°C	1.35	1.6	2.2	1.35	1.6	2.2	mA
		Full range	2.2			2.2			
$I_{OS}$ Short-circuit output current	$V_O = 0$	25°C	$V_{ID} = 1\text{ V}$			$V_{ID} = -1\text{ V}$			mA
			-35			-35			
			45			45			

† Full range is 0°C to 70°C.

**TLE2071C operating characteristics at specified free-air temperature,  $V_{CC\pm} = \pm 5\text{ V}$**

PARAMETER	TEST CONDITIONS	$T_A$ †	TLE2071C			TLE2071AC			UNIT	
			MIN	TYP	MAX	MIN	TYP	MAX		
SR+ Positive slew rate	$V_{O(PP)} = \pm 2.3\text{ V}$ , $A_{VD} = -1$ , $C_L = 100\text{ pF}$ , $R_L = 2\text{ k}\Omega$ , See Figure 1	25°C	35			35			V/ $\mu$ s	
		Full range	23			23				
SR- Negative slew rate		25°C	38			38			V/ $\mu$ s	
		Full range	23			23				
$t_s$ Settling time	$A_{VD} = -1$ , 2-V step, $R_L = 1\text{ k}\Omega$ , $C_L = 100\text{ pF}$	25°C	To 10 mV	0.25			0.25			$\mu$ s
			To 1 mV	0.4			0.4			
$V_n$ Equivalent input noise voltage	$R_S = 20\ \Omega$ , See Figure 3	25°C	f = 10 Hz	28	55	28	55	nV/ $\sqrt{\text{Hz}}$		
			f = 10 kHz	11.6	17	11.6	17			
$V_{N(PP)}$ Peak-to-peak equivalent input noise voltage		f = 10 Hz to 10 kHz	25°C	6			6			$\mu$ V
				f = 0.1 Hz to 10 Hz	0.6			0.6		
$I_n$ Equivalent input noise current	$V_{IC} = 0$ , f = 10 kHz	25°C	2.8			2.8			fA/ $\sqrt{\text{Hz}}$	
THD + N Total harmonic distortion plus noise	$V_{O(PP)} = 5\text{ V}$ , f = 1 kHz, $R_S = 25\ \Omega$	$A_{VD} = 10$ , $R_L = 2\text{ k}\Omega$	25°C	0.013%			0.013%			
$B_1$ Unity-gain bandwidth	$V_I = 10\text{ mV}$ , $C_L = 25\text{ pF}$ ,	$R_L = 2\text{ k}\Omega$ , See Figure 2	25°C	9.4			9.4			MHz
$B_{OM}$ Maximum output-swing bandwidth	$V_{O(PP)} = 4\text{ V}$ , $R_L = 2\text{ k}\Omega$ ,	$A_{VD} = -1$ , $C_L = 25\text{ pF}$	25°C	2.8			2.8			MHz
$\phi_m$ Phase margin at unity gain	$V_I = 10\text{ mV}$ , $C_L = 25\text{ pF}$ ,	$R_L = 2\text{ k}\Omega$ , See Figure 2	25°C	56°			56°			

† Full range is 0°C to 70°C.

**TLE207x, TLE207xA, TLE207xY**  
**EXCALIBUR LOW-NOISE HIGH-SPEED**  
**JFET-INPUT OPERATIONAL AMPLIFIERS**

SLOS181A – FEBRUARY 1997 – REVISED MARCH 2000

**TLE2071C electrical characteristics at specified free-air temperature,  $V_{CC\pm} = \pm 15$  V (unless otherwise noted)**

PARAMETER	TEST CONDITIONS	T <sub>A</sub> †	TLE2071C			TLE2071AC			UNIT	
			MIN	TYP	MAX	MIN	TYP	MAX		
V <sub>IO</sub> Input offset voltage	V <sub>IC</sub> = 0, V <sub>O</sub> = 0, R <sub>S</sub> = 50 Ω	25°C	0.49		4	0.47		2	mV	
		Full range			6			4		
α <sub>VIO</sub> Temperature coefficient of input offset voltage		Full range	3.2		29	3.2		29	μV/°C	
I <sub>IO</sub> Input offset current	V <sub>IC</sub> = 0, V <sub>O</sub> = 0, See Figure 4	25°C	6		100	6		100	pA	
		Full range			1.4			1.4	nA	
I <sub>IB</sub> Input bias current		25°C	20		175	20		175	pA	
		Full range			5			5	nA	
V <sub>ICR</sub> Common-mode input voltage range	R <sub>S</sub> = 50 Ω	25°C	15 to -11	15 to -11.9		15 to -11	15 to -11.9		V	
		Full range	15 to -10.9			15 to -10.9				
V <sub>OM+</sub> Maximum positive peak output voltage swing	I <sub>O</sub> = -200 μA	25°C	13.8	14.1		13.8	14.1		V	
		Full range	13.7			13.7				
	I <sub>O</sub> = -2 mA	25°C	13.5	13.9		13.5	13.9			
		Full range	13.4			13.4				
	I <sub>O</sub> = -20 mA	25°C	11.5	12.3		11.5	12.3			
		Full range	11.5			11.5				
V <sub>OM-</sub> Maximum negative peak output voltage swing	I <sub>O</sub> = 200 μA	25°C	-13.8	-14.2		-13.8	-14.2		V	
		Full range	-13.7			-13.7				
	I <sub>O</sub> = 2 mA	25°C	-13.5	-14		-13.5	-14			
		Full range	-13.4			-13.4				
	I <sub>O</sub> = 20 mA	25°C	-11.5	-12.4		-11.5	-12.4			
		Full range	-11.5			-11.5				
A <sub>VD</sub> Large-signal differential voltage amplification	V <sub>O</sub> = ± 10 V	R <sub>L</sub> = 600 Ω	25°C	80	96		80	96	dB	
			Full range	79			79			
		R <sub>L</sub> = 2 kΩ	25°C	90	109		90	109		
			Full range	89			89			
		R <sub>L</sub> = 10 kΩ	25°C	95	118		95	118		
			Full range	94			94			
r <sub>i</sub> Input resistance	V <sub>IC</sub> = 0	25°C	10 <sup>12</sup>			10 <sup>12</sup>		Ω		
c <sub>i</sub> Input capacitance	V <sub>IC</sub> = 0, See Figure 5	Common mode	25°C	7.5			7.5		pF	
		Differential	25°C	2.5			2.5			
z <sub>o</sub> Open-loop output impedance	f = 1 MHz	25°C	80			80		Ω		
CMRR Common-mode rejection ratio	V <sub>IC</sub> = V <sub>ICRmin</sub> , V <sub>O</sub> = 0, R <sub>S</sub> = 50 Ω	25°C	80	98		80	98	dB		
		Full range	79			79				
k <sub>SVR</sub> Supply-voltage rejection ratio (ΔV <sub>CC±</sub> /ΔV <sub>IO</sub> )	V <sub>CC±</sub> = ±5 V to ±15 V, V <sub>O</sub> = 0, R <sub>S</sub> = 50 Ω	25°C	82	99		82	99	dB		
		Full range	80			81				

† Full range is 0°C to 70°C.

**TLE207x, TLE207xA, TLE207xY**  
**EXCALIBUR LOW-NOISE HIGH-SPEED**  
**JFET-INPUT OPERATIONAL AMPLIFIERS**  
 SLOS181A – FEBRUARY 1997 – REVISED MARCH 2000

**TLE2071C electrical characteristics at specified free-air temperature,  $V_{CC\pm} = \pm 15$  V (unless otherwise noted) (continued)**

PARAMETER	TEST CONDITIONS	$T_A$ †	TLE2071C			TLE2071AC			UNIT
			MIN	TYP	MAX	MIN	TYP	MAX	
$I_{CC}$ Supply current	$V_O = 0$ , No load	25°C	1.35	1.7	2.2	1.35	1.7	2.2	mA
		Full range	2.2			2.2			
$I_{OS}$ Short-circuit output current	$V_O = 0$	25°C	-30	-45		-30	-45		mA
			30	48		30	48		

† Full range is 0°C to 70°C.

**TLE2071C operating characteristics at specified free-air temperature,  $V_{CC\pm} = \pm 15$  V**

PARAMETER	TEST CONDITIONS	$T_A$ †	TLE2071C			TLE2071AC			UNIT
			MIN	TYP	MAX	MIN	TYP	MAX	
SR+ Positive slew rate	$V_{O(PP)} = 10$ V, $A_{VD} = -1$ , $R_L = 2$ k $\Omega$ , See Figure 1	25°C	30	40		30	40		V/ $\mu$ s
		Full range	27			27			
SR- Negative slew rate		25°C	30	45		30	45		V/ $\mu$ s
		Full range	27			27			
$t_s$ Settling time	$A_{VD} = -1$ , 10-V step, $R_L = 1$ k $\Omega$ , $C_L = 100$ pF	25°C	0.4			0.4			$\mu$ s
			1.5			1.5			
$V_n$ Equivalent input noise voltage		25°C	28	55		28	55		nV/ $\sqrt{Hz}$
			11.6	17		11.6	17		
$V_{N(PP)}$ Peak-to-peak equivalent input noise voltage	$R_S = 20$ $\Omega$ , See Figure 3	25°C	6			6			$\mu$ V
			0.6			0.6			
$I_n$ Equivalent input noise current	$V_{IC} = 0$ , $f = 10$ kHz	25°C	2.8			2.8			fA/ $\sqrt{Hz}$
THD + N Total harmonic distortion plus noise	$V_{O(PP)} = 20$ V, $A_{VD} = 10$ , $f = 1$ kHz, $R_S = 25$ $\Omega$	25°C	0.008%			0.008%			
$B_1$ Unity-gain bandwidth	$V_I = 10$ mV, $R_L = 2$ k $\Omega$ , $C_L = 25$ pF, See Figure 2	25°C	8	10		8	10		MHz
$B_{OM}$ Maximum output-swing bandwidth	$V_{O(PP)} = 20$ V, $A_{VD} = -1$ , $R_L = 2$ k $\Omega$ , $C_L = 25$ pF	25°C	478	637		478	637		kHz
$\phi_m$ Phase margin at unity gain	$V_I = 10$ mV, $R_L = 2$ k $\Omega$ , $C_L = 25$ pF, See Figure 2	25°C	57°			57°			

† Full range is 0°C to 70°C.

**TLE207x, TLE207xA, TLE207xY**  
**EXCALIBUR LOW-NOISE HIGH-SPEED**  
**JFET-INPUT OPERATIONAL AMPLIFIERS**

SLOS181A – FEBRUARY 1997 – REVISED MARCH 2000

**TLE2071I electrical characteristics at specified free-air temperature,  $V_{CC\pm} = \pm 5\text{ V}$  (unless otherwise noted)**

PARAMETER	TEST CONDITIONS	$T_A$ †	TLE2071I			TLE2071AI			UNIT	
			MIN	TYP	MAX	MIN	TYP	MAX		
$V_{IO}$ Input offset voltage	$V_{IC} = 0, V_O = 0, R_S = 50\ \Omega$	25°C	0.34		4	0.3		2	mV	
		Full range			7.6			5.6		
$\alpha_{VIO}$ Temperature coefficient of input offset voltage		Full range	3.2		29	3.2		29	$\mu\text{V}/^\circ\text{C}$	
$I_{IO}$ Input offset current	$V_{IC} = 0, V_O = 0, \text{See Figure 4}$	25°C	5		100	5		100	pA	
		Full range			5			5	nA	
$I_{IB}$ Input bias current		25°C	15		175	15		175	pA	
		Full range			10			10	nA	
$V_{ICR}$ Common-mode input voltage range	$R_S = 50\ \Omega$	25°C	5 to -1		5 to -1.9	5 to -1		5 to -1.9	V	
		Full range	5 to -0.8			5 to -0.8				
$V_{OM+}$ Maximum positive peak output voltage swing	$I_O = -200\ \mu\text{A}$	25°C	3.8		4.1	3.8		4.1	V	
		Full range			3.7			3.7		
	$I_O = -2\ \text{mA}$	25°C	3.5		3.9	3.5		3.9		
		Full range			3.4			3.4		
	$I_O = -20\ \text{mA}$	25°C	1.5		2.3	1.5		2.3		
		Full range			1.5			1.5		
$V_{OM-}$ Maximum negative peak output voltage swing	$I_O = 200\ \mu\text{A}$	25°C	-3.8		-4.2	-3.8		-4.2	V	
		Full range			-3.7			-3.7		
	$I_O = 2\ \text{mA}$	25°C	-3.5		-4.1	-3.5		-4.1		
		Full range			-3.4			-3.4		
	$I_O = 20\ \text{mA}$	25°C	-1.5		-2.4	-1.5		-2.4		
		Full range			-1.5			-1.5		
$A_{VD}$ Large-signal differential voltage amplification	$V_O = \pm 2.3\ \text{V}$	$R_L = 600\ \Omega$	25°C	80		91	80		91	dB
			Full range			79			79	
		$R_L = 2\ \text{k}\Omega$	25°C	90		100	90		100	
			Full range			89			89	
		$R_L = 10\ \text{k}\Omega$	25°C	95		106	95		106	
			Full range			94			94	
$r_i$ Input resistance	$V_{IC} = 0$	25°C	10 <sup>12</sup>			10 <sup>12</sup>		$\Omega$		
$c_i$ Input capacitance	$V_{IC} = 0, \text{See Figure 5}$	Common mode	25°C		11		11		pF	
		Differential	25°C		2.5		2.5			
$z_o$ Open-loop output impedance	$f = 1\ \text{MHz}$	25°C	80			80		$\Omega$		
CMRR Common-mode rejection ratio	$V_{IC} = V_{ICRmin}, V_O = 0, R_S = 50\ \Omega$	25°C	70		89	70		89	dB	
		Full range			68			68		
$k_{SVR}$ Supply-voltage rejection ratio ( $\Delta V_{CC\pm}/\Delta V_{IO}$ )	$V_{CC\pm} = \pm 5\ \text{V to } \pm 15\ \text{V}, V_O = 0, R_S = 50\ \Omega$	25°C	82		99	82		99	dB	
		Full range			80			80		

† Full range is -40°C to 85°C.

**TLE207x, TLE207xA, TLE207xY**  
**EXCALIBUR LOW-NOISE HIGH-SPEED**  
**JFET-INPUT OPERATIONAL AMPLIFIERS**  
 SLOS181A – FEBRUARY 1997 – REVISED MARCH 2000

**TLE2071I electrical characteristics at specified free-air temperature,  $V_{CC\pm} = \pm 5$  V (unless otherwise noted) (continued)**

PARAMETER	TEST CONDITIONS	$T_A$ †	TLE2071I			TLE2071AI			UNIT
			MIN	TYP	MAX	MIN	TYP	MAX	
$I_{CC}$ Supply current	$V_O = 0$ , No load	25°C	1.35	1.6	2.2	1.35	1.6	2.2	mA
		Full range	2.2			2.2			
$I_{OS}$ Short-circuit output current	$V_O = 0$	25°C	$V_{ID} = 1$ V			–35			mA
			$V_{ID} = -1$ V			45			

† Full range is –40°C to 85°C.

**TLE2071I operating characteristics at specified free-air temperature,  $V_{CC\pm} = \pm 5$  V**

PARAMETER	TEST CONDITIONS	$T_A$ †	TLE2071I			TLE2071AI			UNIT
			MIN	TYP	MAX	MIN	TYP	MAX	
SR+ Positive slew rate	$V_{O(PP)} = \pm 2.3$ V, $A_{VD} = -1$ , $R_L = 2$ k $\Omega$ , $C_L = 100$ pF, See Figure 1	25°C	35			35			V/ $\mu$ s
		Full range	22			22			
SR– Negative slew rate		25°C	38			38			V/ $\mu$ s
		Full range	22			22			
$t_s$ Settling time	$A_{VD} = -1$ , 2-V step, $R_L = 1$ k $\Omega$ , $C_L = 100$ pF	25°C	To 10 mV			0.25			$\mu$ s
			To 1 mV			0.4			
$V_n$ Equivalent input noise voltage		25°C	f = 10 Hz		28		55		nV/ $\sqrt{Hz}$
			f = 10 kHz		11.6		17		
$V_{N(PP)}$ Peak-to-peak equivalent input noise voltage	$R_S = 20$ $\Omega$ , See Figure 3	25°C	f = 10 Hz to 10 kHz		6		6		$\mu$ V
			f = 0.1 Hz to 10 Hz		0.6		0.6		
$I_n$ Equivalent input noise current	$V_{IC} = 0$ , f = 10 kHz	25°C	2.8		2.8		fA/ $\sqrt{Hz}$		
THD + N Total harmonic distortion plus noise	$V_{O(PP)} = 5$ V, $A_{VD} = 10$ , f = 1 kHz, $R_L = 2$ k $\Omega$ , $R_S = 25$ $\Omega$	25°C	0.013%		0.013%				
$B_1$ Unity-gain bandwidth	$V_I = 10$ mV, $R_L = 2$ k $\Omega$ , $C_L = 25$ pF, See Figure 2	25°C	9.4		9.4		MHz		
$B_{OM}$ Maximum output-swing bandwidth	$V_{O(PP)} = 4$ V, $A_{VD} = -1$ , $R_L = 2$ k $\Omega$ , $C_L = 25$ pF	25°C	2.8		2.8		MHz		
$\phi_m$ Phase margin at unity gain	$V_I = 10$ mV, $R_L = 2$ k $\Omega$ , $C_L = 25$ pF, See Figure 2	25°C	56°		56°				

† Full range is –40°C to 85°C.

# TLE207x, TLE207xA, TLE207xY EXCALIBUR LOW-NOISE HIGH-SPEED JFET-INPUT OPERATIONAL AMPLIFIERS

SLOS181A – FEBRUARY 1997 – REVISED MARCH 2000

**TLE2071I electrical characteristics at specified free-air temperature,  $V_{CC\pm} = \pm 15$  V (unless otherwise noted)**

PARAMETER	TEST CONDITIONS	$T_A$ †	TLE2071I			TLE2071AI			UNIT	
			MIN	TYP	MAX	MIN	TYP	MAX		
$V_{IO}$ Input offset voltage	$V_{IC} = 0,$ $R_S = 50 \Omega,$ $V_O = 0,$	25°C	0.49		4	0.47		2	mV	
		Full range			7.6			5.6		
$\alpha_{VIO}$ Temperature coefficient of input offset voltage		Full range	3.2		29	3.2		29	$\mu\text{V}/^\circ\text{C}$	
$I_{IO}$ Input offset current	$V_{IC} = 0,$ $V_O = 0,$ See Figure 4	25°C	6		100	6		100	pA	
		Full range			5			5	nA	
$I_{IB}$ Input bias current		25°C	20		175	20		175	pA	
		Full range			10			10	nA	
$V_{ICR}$ Common-mode input voltage range	$R_S = 50 \Omega$	25°C	15 to -11	15 to -11.9		15 to -11	15 to -11.9		V	
		Full range	15 to -10.8			15 to -10.8				
$V_{OM+}$ Maximum positive peak output voltage swing	$I_O = -200 \mu\text{A}$	25°C	13.8	14.1		13.8	14.1		V	
		Full range	13.7			13.7				
	$I_O = -2 \text{ mA}$	25°C	13.5	13.9		13.5	13.9			
		Full range	13.4			13.4				
	$I_O = -20 \text{ mA}$	25°C	11.5	12.3		11.5	12.3			
		Full range	11.5			11.5				
$V_{OM-}$ Maximum negative peak output voltage swing	$I_O = 200 \mu\text{A}$	25°C	-13.8	-14.2		-13.8	-14.2		V	
		Full range	-13.7			-13.7				
	$I_O = 2 \text{ mA}$	25°C	-13.5	-14		-13.5	-14			
		Full range	-13.4			-13.4				
	$I_O = 20 \text{ mA}$	25°C	-11.5	-12.4		-11.5	-12.4			
		Full range	-11.5			-11.5				
$A_{VD}$ Large-signal differential voltage amplification	$V_O = \pm 10 \text{ V}$	$R_L = 600 \Omega$	25°C	80	96		80	96	dB	
			Full range	79			79			
		$R_L = 2 \text{ k}\Omega$	25°C	90	109		90	109		
			Full range	89			89			
		$R_L = 10 \text{ k}\Omega$	25°C	95	118		95	118		
			Full range	94			94			
$r_i$ Input resistance	$V_{IC} = 0$	25°C	10 <sup>12</sup>			10 <sup>12</sup>		$\Omega$		
$c_i$ Input capacitance	$V_{IC} = 0,$ See Figure 5	Common mode	25°C		7.5		7.5		pF	
		Differential	25°C		2.5		2.5			
$z_o$ Open-loop output impedance	$f = 1 \text{ MHz}$	25°C	80			80		$\Omega$		
CMRR Common-mode rejection ratio	$V_{IC} = V_{ICRmin},$ $V_O = 0,$ $R_S = 50 \Omega$	25°C	80	98		80	98	dB		
		Full range	79			79				
$k_{SVR}$ Supply-voltage rejection ratio ( $\Delta V_{CC\pm}/\Delta V_{IO}$ )	$V_{CC\pm} = \pm 5 \text{ V to } \pm 15 \text{ V},$ $V_O = 0,$ $R_S = 50 \Omega$	25°C	82	99		82	99	dB		
		Full range	80			80				

† Full range is  $-40^\circ\text{C}$  to  $85^\circ\text{C}$ .



**TLE207x, TLE207xA, TLE207xY**  
**EXCALIBUR LOW-NOISE HIGH-SPEED**  
**JFET-INPUT OPERATIONAL AMPLIFIERS**

SLOS181A – FEBRUARY 1997 – REVISED MARCH 2000

**TLE2071I electrical characteristics at specified free-air temperature,  $V_{CC\pm} = \pm 15$  V (unless otherwise noted) (continued)**

PARAMETER	TEST CONDITIONS	$T_A$ †	TLE2071I			TLE2071AI			UNIT
			MIN	TYP	MAX	MIN	TYP	MAX	
$I_{CC}$ Supply current	$V_O = 0$ , No load	25°C	1.35	1.7	2.2	1.35	1.7	2.2	mA
		Full range	2.2			2.2			
$I_{OS}$ Short-circuit output current	$V_O = 0$	25°C	$V_{ID} = 1$ V		-30	-45	-30	-45	mA
			$V_{ID} = -1$ V		30	48	30	48	

† Full range is  $-40^\circ\text{C}$  to  $85^\circ\text{C}$ .

**TLE2071I operating characteristics at specified free-air temperature,  $V_{CC\pm} = \pm 15$  V**

PARAMETER	TEST CONDITIONS	$T_A$ †	TLE2071I			TLE2071AI			UNIT
			MIN	TYP	MAX	MIN	TYP	MAX	
$SR+$ Positive slew rate	$V_{O(PP)} = \pm 10$ V, $A_{VD} = -1$ , $C_L = 100$ pF, $R_L = 2$ k $\Omega$ , See Figure 1	25°C	30	40		30	40		V/ $\mu$ s
		Full range	24			24			
$SR-$ Negative slew rate	$V_{O(PP)} = \pm 10$ V, $A_{VD} = -1$ , $C_L = 100$ pF, $R_L = 2$ k $\Omega$ , See Figure 1	25°C	30	45		30	45		V/ $\mu$ s
		Full range	24			24			
$t_s$ Settling time	$A_{VD} = -1$ , 10-V step, $R_L = 1$ k $\Omega$ , $C_L = 100$ pF	To 10 mV	0.4			0.4			$\mu$ s
		To 1 mV	1.5			1.5			
$V_n$ Equivalent input noise voltage	$R_S = 20$ $\Omega$ , See Figure 3	f = 10 Hz	28	55		28	55	nV/ $\sqrt{\text{Hz}}$	
		f = 10 kHz	11.6	17		11.6	17		
$V_{N(PP)}$ Peak-to-peak equivalent input noise voltage	$R_S = 20$ $\Omega$ , See Figure 3	f = 10 Hz to 10 kHz	6			6			$\mu$ V
		f = 0.1 Hz to 10 Hz	0.6			0.6			
$I_n$ Equivalent input noise current	$V_{IC} = 0$ , f = 10 kHz	25°C	2.8			2.8			fA/ $\sqrt{\text{Hz}}$
THD + N Total harmonic distortion plus noise	$V_{O(PP)} = 20$ V, $A_{VD} = 10$ , f = 1 kHz, $R_L = 2$ k $\Omega$ , $R_S = 25$ $\Omega$	25°C	0.008%			0.008%			
$B_1$ Unity-gain bandwidth	$V_I = 10$ mV, $R_L = 2$ k $\Omega$ , $C_L = 25$ pF, See Figure 2	25°C	8	10		8	10	MHz	
$B_{OM}$ Maximum output-swing bandwidth	$V_{O(PP)} = 20$ V, $A_{VD} = -1$ , $R_L = 2$ k $\Omega$ , $C_L = 25$ pF	25°C	478	637		478	637	kHz	
$\phi_m$ Phase margin at unity gain	$V_I = 10$ mV, $R_L = 2$ k $\Omega$ , $C_L = 25$ pF, See Figure 2	25°C	57°			57°			

† Full range is  $-40^\circ\text{C}$  to  $85^\circ\text{C}$ .

# TLE207x, TLE207xA, TLE207xY EXCALIBUR LOW-NOISE HIGH-SPEED JFET-INPUT OPERATIONAL AMPLIFIERS

SLOS181A – FEBRUARY 1997 – REVISED MARCH 2000

**TLE2071M electrical characteristics at specified free-air temperature,  $V_{CC\pm} = \pm 5$  V (unless otherwise noted)**

PARAMETER	TEST CONDITIONS	T <sub>A</sub> †	TLE2071M			TLE2071AM			UNIT	
			MIN	TYP	MAX	MIN	TYP	MAX		
V <sub>IO</sub> Input offset voltage	V <sub>IC</sub> = 0, V <sub>O</sub> = 0, R <sub>S</sub> = 50 Ω	25°C	0.34		4	0.3		2	mV	
		Full range			9.2			7.2		
α <sub>VIO</sub> Temperature coefficient of input offset voltage		Full range	3.2		29*	3.2		29*	μV/°C	
I <sub>IO</sub> Input offset current	V <sub>IC</sub> = 0, V <sub>O</sub> = 0, See Figure 4	25°C	5		100	5		100	pA	
		Full range			20			20	nA	
I <sub>IB</sub> Input bias current		25°C	15		175	15		175	pA	
		Full range			60			60	nA	
V <sub>ICR</sub> Common-mode input voltage range	R <sub>S</sub> = 50 Ω	25°C	5 to -1	5 to -1.9		5 to -1	5 to -1.9		V	
		Full range	5 to -0.8			5 to -0.8				
V <sub>OM+</sub> Maximum positive peak output voltage swing	I <sub>O</sub> = -200 μA	25°C	3.8		4.1	3.8		4.1	V	
		Full range			3.6			3.6		
	I <sub>O</sub> = -2 mA	25°C	3.5		3.9	3.5		3.9		
		Full range			3.3			3.3		
	I <sub>O</sub> = -20 mA	25°C	1.5		2.3	1.5		2.3		
		Full range			1.4			1.4		
V <sub>OM-</sub> Maximum negative peak output voltage swing	I <sub>O</sub> = 200 μA	25°C	-3.8		-4.2	-3.8		-4.2	V	
		Full range			-3.6			-3.6		
	I <sub>O</sub> = 2 mA	25°C	-3.5		-4.1	-3.5		-4.1		
		Full range			-3.3			-3.3		
	I <sub>O</sub> = 20 mA	25°C	-1.5		-2.4	-1.5		-2.4		
		Full range			-1.4			-1.4		
A <sub>VD</sub> Large-signal differential voltage amplification	V <sub>O</sub> = ± 2.3 V	R <sub>L</sub> = 600 Ω	25°C	80		91	80		91	dB
			Full range			78			78	
		R <sub>L</sub> = 2 kΩ	25°C	90		100	90		100	
			Full range			88			88	
		R <sub>L</sub> = 10 kΩ	25°C	95		106	95		106	
			Full range			93			93	
r <sub>i</sub> Input resistance	V <sub>IC</sub> = 0	25°C	10 <sup>12</sup>			10 <sup>12</sup>		Ω		
c <sub>i</sub> Input capacitance	V <sub>IC</sub> = 0, See Figure 5	Common mode	25°C	11			11		pF	
		Differential	25°C	2.5			2.5			
z <sub>o</sub> Open-loop output impedance	f = 1 MHz	25°C	80			80		Ω		
CMRR Common-mode rejection ratio	V <sub>IC</sub> = V <sub>ICRmin</sub> , V <sub>O</sub> = 0, R <sub>S</sub> = 50 Ω	25°C	70		89	70		89	dB	
		Full range			68			68		
k <sub>SVR</sub> Supply-voltage rejection ratio (ΔV <sub>CC±</sub> /ΔV <sub>IO</sub> )	V <sub>CC±</sub> = ±5 V to ±15 V, V <sub>O</sub> = 0, R <sub>S</sub> = 50 Ω	25°C	82		99	82		99	dB	
		Full range			80			80		

\*On products compliant to MIL-PRF-38535, Class B, this parameter is not production tested.

† Full range is -55°C to 125°C.

**TLE207x, TLE207xA, TLE207xY**  
**EXCALIBUR LOW-NOISE HIGH-SPEED**  
**JFET-INPUT OPERATIONAL AMPLIFIERS**

SLOS181A – FEBRUARY 1997 – REVISED MARCH 2000

**TLE2071M electrical characteristics at specified free-air temperature,  $V_{CC\pm} = \pm 5\text{ V}$  (unless otherwise noted)**

PARAMETER	TEST CONDITIONS	$T_A$ †	TLE2071M			TLE2071AM			UNIT
			MIN	TYP	MAX	MIN	TYP	MAX	
$I_{CC}$ Supply current	$V_O = 0$ , No load	25°C	1.35	1.6	2.2	1.35	1.6	2.2	mA
		Full range	2.2			2.2			
$I_{OS}$ Short-circuit output current	$V_O = 0$	25°C	$V_{ID} = 1\text{ V}$			$-35$			mA
			$V_{ID} = -1\text{ V}$			45			

† Full range is  $-55^\circ\text{C}$  to  $125^\circ\text{C}$ .

**TLE2071M operating characteristics at specified free-air temperature,  $V_{CC\pm} = \pm 5\text{ V}$**

PARAMETER	TEST CONDITIONS	$T_A$ †	TLE2071M			TLE2071AM			UNIT	
			MIN	TYP	MAX	MIN	TYP	MAX		
SR+ Positive slew rate	$V_{O(PP)} = \pm 2.3\text{ V}$ , $A_{VD} = -1$ , $R_L = 2\text{ k}\Omega$ , $C_L = 100\text{ pF}$ , See Figure 1	25°C	35			35			$\text{V}/\mu\text{s}$	
		Full range	20*			20*				
SR- Negative slew rate		25°C	38			38			$\text{V}/\mu\text{s}$	
		Full range	20*			20*				
$t_s$ Settling time	$A_{VD} = -1$ , 2-V step, $R_L = 1\text{ k}\Omega$ , $C_L = 100\text{ pF}$	25°C	To 10 mV			0.25			$\mu\text{s}$	
			To 1 mV			0.4				
$V_n$ Equivalent input noise voltage		25°C	f = 10 Hz			28 55*			$\text{nV}/\sqrt{\text{Hz}}$	
			f = 10 kHz			11.6 17*				
$V_{N(PP)}$ Peak-to-peak equivalent input noise voltage	$R_S = 20\ \Omega$ , See Figure 3	25°C	f = 10 Hz to 10 kHz			6			$\mu\text{V}$	
			f = 0.1 Hz to 10 Hz			0.6				
$I_n$ Equivalent input noise current	$V_{IC} = 0$ , f = 10 kHz	25°C	2.8			2.8			$\text{fA}/\sqrt{\text{Hz}}$	
THD + N Total harmonic distortion plus noise	$V_{O(PP)} = 5\text{ V}$ , f = 1 kHz, $R_S = 25\ \Omega$	$A_{VD} = 10$ , $R_L = 2\text{ k}\Omega$ ,	25°C	0.013%			0.013%			
$B_1$ Unity-gain bandwidth	$V_I = 10\text{ mV}$ , $C_L = 25\text{ pF}$ ,	$R_L = 2\text{ k}\Omega$ , See Figure 2	25°C	9.4			9.4			MHz
$B_{OM}$ Maximum output-swing bandwidth	$V_{O(PP)} = 4\text{ V}$ , $R_L = 2\text{ k}\Omega$ ,	$A_{VD} = -1$ , $C_L = 25\text{ pF}$	25°C	2.8			2.8			MHz
$\phi_m$ Phase margin at unity gain	$V_I = 10\text{ mV}$ , $C_L = 25\text{ pF}$ ,	$R_L = 2\text{ k}\Omega$ , See Figure 2	25°C	56°			56°			

\*On products compliant to MIL-PRF-38535, Class B, this parameter is not production tested.

† Full range is  $-55^\circ\text{C}$  to  $125^\circ\text{C}$ .

**TLE207x, TLE207xA, TLE207xY**  
**EXCALIBUR LOW-NOISE HIGH-SPEED**  
**JFET-INPUT OPERATIONAL AMPLIFIERS**

SLOS181A – FEBRUARY 1997 – REVISED MARCH 2000

**TLE2071M electrical characteristics at specified free-air temperature,  $V_{CC\pm} = \pm 15$  V (unless otherwise noted)**

PARAMETER	TEST CONDITIONS	$T_A$ †	TLE2071M			TLE2071AM			UNIT
			MIN	TYP	MAX	MIN	TYP	MAX	
$V_{IO}$ Input offset voltage	$V_{IC} = 0, V_O = 0, R_S = 50 \Omega$	25°C	0.49		4	0.47		2	mV
		Full range			9.2			7.2	
$\alpha_{VIO}$ Temperature coefficient of input offset voltage		Full range	3.2		29*	3.2		29*	$\mu\text{V}/^\circ\text{C}$
$I_{IO}$ Input offset current	$V_{IC} = 0, V_O = 0, \text{See Figure 4}$	25°C	6		100	6		100	pA
		Full range			20			20	nA
$I_{IB}$ Input bias current		25°C	20		175	20		175	pA
		Full range			60			60	nA
$V_{ICR}$ Common-mode input voltage range	$R_S = 50 \Omega$	25°C	15 to -11	15 to -11.9		15 to -11	15 to -11.9		V
		Full range	15 to -10.9			15 to -10.9			
$V_{OM+}$ Maximum positive peak output voltage swing	$I_O = -200 \mu\text{A}$	25°C	13.8	14.1		13.8	14.1		V
		Full range	13.6			13.6			
	$I_O = -2 \text{ mA}$	25°C	13.5	13.9		13.5	13.9		
		Full range	13.3			13.3			
	$I_O = -20 \text{ mA}$	25°C	11.5	12.3		11.5	12.3		
		Full range	11.4			11.4			
$V_{OM-}$ Maximum negative peak output voltage swing	$I_O = 200 \mu\text{A}$	25°C	-13.8	-14.2		-13.8	-14.2		V
		Full range	-13.6			-13.6			
	$I_O = 2 \text{ mA}$	25°C	-13.5	-14		-13.5	-14		
		Full range	-13.3			-13.3			
	$I_O = 20 \text{ mA}$	25°C	-11.5	-12.4		-11.5	-12.4		
		Full range	-11.4			-11.4			
$AVD$ Large-signal differential voltage amplification	$V_O = \pm 10 \text{ V}$	$R_L = 600 \Omega$	25°C	80	96		80	96	dB
			Full range	78			78		
		$R_L = 2 \text{ k}\Omega$	25°C	90	109		90	109	
			Full range	88			88		
		$R_L = 10 \text{ k}\Omega$	25°C	95	118		95	118	
			Full range	93			93		
$r_i$ Input resistance	$V_{IC} = 0$	25°C	$10^{12}$			$10^{12}$		$\Omega$	
$c_i$ Input capacitance	$V_{IC} = 0, \text{See Figure 5}$	Common mode	25°C	7.5			7.5		pF
		Differential	25°C	2.5			2.5		
$z_o$ Open-loop output impedance	$f = 1 \text{ MHz}$	25°C	80			80		$\Omega$	
CMRR Common-mode rejection ratio	$V_{IC} = V_{ICRmin}, V_O = 0, R_S = 50 \Omega$	25°C	80	98		80	98	dB	
		Full range	78			78			
$k_{SVR}$ Supply-voltage rejection ratio ( $\Delta V_{CC\pm}/\Delta V_{IO}$ )	$V_{CC\pm} = \pm 5 \text{ V to } \pm 15 \text{ V}, V_O = 0, R_S = 50 \Omega$	25°C	82	99		82	99	dB	
		Full range	80			80			

\*On products compliant to MIL-PRF-38535, Class B, this parameter is not production tested.

† Full range is  $-55^\circ\text{C}$  to  $125^\circ\text{C}$ .

**TLE207x, TLE207xA, TLE207xY**  
**EXCALIBUR LOW-NOISE HIGH-SPEED**  
**JFET-INPUT OPERATIONAL AMPLIFIERS**

SLOS181A – FEBRUARY 1997 – REVISED MARCH 2000

**TLE2071M electrical characteristics at specified free-air temperature,  $V_{CC\pm} = \pm 15\text{ V}$  (unless otherwise noted) (continued)**

PARAMETER	TEST CONDITIONS	$T_A$ †	TLE2071M			TLE2071AM			UNIT
			MIN	TYP	MAX	MIN	TYP	MAX	
$I_{CC}$ Supply current	$V_O = 0$ , No load	25°C	1.35	1.7	2.2	1.35	1.7	2.2	mA
		Full range	2.2			2.2			
$I_{OS}$ Short-circuit output current	$V_O = 0$	25°C	$V_{ID} = 1\text{ V}$		-30	-45	-30	-45	mA
			$V_{ID} = -1\text{ V}$		30	48	30	48	

† Full range is  $-55^\circ\text{C}$  to  $125^\circ\text{C}$ .

**TLE2071M operating characteristics at specified free-air temperature,  $V_{CC\pm} = \pm 15\text{ V}$**

PARAMETER	TEST CONDITIONS	$T_A$ †	TLE2071M			TLE2071AM			UNIT	
			MIN	TYP	MAX	MIN	TYP	MAX		
$SR+$ Positive slew rate	$V_{O(PP)} = 10\text{ V}$ , $A_{VD} = -1$ , $R_L = 2\text{ k}\Omega$ , See Figure 1	25°C	30	40		30	40		$\text{V}/\mu\text{s}$	
		Full range	22			22				
$SR-$ Negative slew rate		25°C	30	45		30	45		$\text{V}/\mu\text{s}$	
		Full range	22			22				
$t_s$ Settling time	$A_{VD} = -1$ , 10-V step, $R_L = 1\text{ k}\Omega$ , $C_L = 100\text{ pF}$	25°C	To 10 mV		0.4		0.4		$\mu\text{s}$	
			To 1 mV		1.5		1.5			
$V_n$ Equivalent input noise voltage	$R_S = 20\ \Omega$ , See Figure 3	25°C	$f = 10\text{ Hz}$		28	55*	28	55*	$\text{nV}/\sqrt{\text{Hz}}$	
			$f = 10\text{ kHz}$		11.6	17*	11.6	17*		
$V_{N(PP)}$ Peak-to-peak equivalent input noise voltage		$f = 10\text{ Hz to } 10\text{ kHz}$	25°C			6		6		$\mu\text{V}$
				$f = 0.1\text{ Hz to } 10\text{ Hz}$		0.6		0.6		
$I_n$ Equivalent input noise current	$V_{IC} = 0$ , $f = 10\text{ kHz}$	25°C			2.8		2.8		$\text{fA}/\sqrt{\text{Hz}}$	
THD + N Total harmonic distortion plus noise	$V_{O(PP)} = 20\text{ V}$ , $A_{VD} = 10$ , $f = 1\text{ kHz}$ , $R_S = 25\ \Omega$	25°C			0.008%		0.008%			
$B_1$ Unity-gain bandwidth	$V_I = 10\text{ mV}$ , $C_L = 25\text{ pF}$ , $R_L = 2\text{ k}\Omega$ , See Figure 2	25°C	8*	10		8*	10		MHz	
$B_{OM}$ Maximum output-swing bandwidth	$V_{O(PP)} = 20\text{ V}$ , $A_{VD} = -1$ , $R_L = 2\text{ k}\Omega$ , $C_L = 25\text{ pF}$	25°C	478*	637		478*	637		kHz	
$\phi_m$ Phase margin at unity gain	$V_I = 10\text{ mV}$ , $C_L = 25\text{ pF}$ , See Figure 2	25°C			57°		57°			

\*On products compliant to MIL-PRF-38535, Class B, this parameter is not production tested.

† Full range is  $-55^\circ\text{C}$  to  $125^\circ\text{C}$ .

**TLE207x, TLE207xA, TLE207xY**  
**EXCALIBUR LOW-NOISE HIGH-SPEED**  
**JFET-INPUT OPERATIONAL AMPLIFIERS**

SLOS181A – FEBRUARY 1997 – REVISED MARCH 2000

**TLE2071Y electrical characteristics at  $V_{CC\pm} = \pm 15\text{ V}$ ,  $T_A = 25^\circ\text{C}$**

PARAMETER	TEST CONDITIONS	TLE2071Y			UNIT	
		MIN	TYP	MAX		
$V_{IO}$ Input offset voltage	$V_{IC} = 0$ , $V_O = 0$ , $R_S = 50\ \Omega$		0.49	4	mV	
$I_{IO}$ Input offset current	$V_{IC} = 0$ , $V_O = 0$ , See Figure 4		6	100	pA	
$I_{IB}$ Input bias current			20	175	pA	
$V_{ICR}$ Common-mode input voltage range	$R_S = 50\ \Omega$	15 to -11	15 to 11.9		V	
$V_{OM+}$ Maximum positive peak output voltage swing	$I_O = -200\ \mu\text{A}$	13.8	14.1		V	
	$I_O = -2\ \text{mA}$	13.5	13.9			
	$I_O = -20\ \text{mA}$	11.5	12.3			
$V_{OM-}$ Maximum negative peak output voltage swing	$I_O = 200\ \mu\text{A}$	-13.8	-14.2		V	
	$I_O = 2\ \text{mA}$	-13.5	-14			
	$I_O = 20\ \text{mA}$	-11.5	-12.4			
$A_{VD}$ Large-signal differential voltage amplification	$V_O = \pm 10\ \text{V}$	$R_L = 600\ \Omega$	80	96	dB	
		$R_L = 2\ \text{k}\Omega$	90	109		
		$R_L = 10\ \text{k}\Omega$	95	118		
$r_i$ Input resistance	$V_{IC} = 0$		$10^{12}$		$\Omega$	
$c_i$ Input capacitance	$V_O = 0$ , See Figure 5	Common mode	7.5		pF	
		Differential	2.5			
$z_o$ Open-loop output impedance	$f = 1\ \text{MHz}$		80		$\Omega$	
CMRR Common-mode rejection ratio	$V_{IC} = V_{ICRmin}$ , $R_S = 50\ \Omega$ , $V_O = 0$		80	98	dB	
$k_{SVR}$ Supply-voltage rejection ratio ( $\Delta V_{CC\pm}/\Delta V_{IO}$ )	$V_{CC\pm} = \pm 5\ \text{V}$ to $\pm 15\ \text{V}$ , $R_S = 50\ \Omega$ , $V_O = 0$		82	99	dB	
$I_{CC}$ Supply current	$V_O = 0$ , No load		1.35	1.7	2.2	mA
$I_{OS}$ Short-circuit output current	$V_O = 0$	$V_{ID} = 1\ \text{V}$	-30	-45	mA	
		$V_{ID} = -1\ \text{V}$	30	48		

**TLE207x, TLE207xA, TLE207xY**  
**EXCALIBUR LOW-NOISE HIGH-SPEED**  
**JFET-INPUT OPERATIONAL AMPLIFIERS**  
SLOS181A – FEBRUARY 1997 – REVISED MARCH 2000

**TLE2072C electrical characteristics at specified free-air temperature,  $V_{CC\pm} = \pm 5$  V (unless otherwise noted)**

PARAMETER	TEST CONDITIONS	$T_A$ †	TLE2072C			TLE2072AC			UNIT	
			MIN	TYP	MAX	MIN	TYP	MAX		
$V_{IO}$ Input offset voltage	$V_{IC} = 0, V_O = 0, R_S = 50 \Omega$	25°C	0.9 6			0.65 3.5			mV	
		Full range	7.8			5.3				
$\alpha_{VIO}$ Temperature coefficient of input offset voltage		Full range	2.3 25			2.3 25			$\mu V/^\circ C$	
$I_{IO}$ Input offset current	$V_{IC} = 0, V_O = 0, \text{ See Figure 4}$	25°C	5 100			5 100			pA	
		Full range	1.4			1.4			nA	
$I_{IB}$ Input bias current		25°C	15 175			15 175			pA	
		Full range	5			5			nA	
$V_{ICR}$ Common-mode input voltage range	$R_S = 50 \Omega$	25°C	5 to -1 to -1.9			5 to -1 to -1.9			V	
		Full range	5 to -0.9			5 to -0.9				
$V_{OM+}$ Maximum positive peak output voltage swing	$I_O = -200 \mu A$	25°C	3.8 4.1			3.8 4.1			V	
		Full range	3.7			3.7				
	$I_O = -2 \text{ mA}$	25°C	3.5 3.9			3.5 3.9				
		Full range	3.4			3.4				
	$I_O = -20 \text{ mA}$	25°C	1.5 2.3			1.5 2.3				
		Full range	1.5			1.5				
$V_{OM-}$ Maximum negative peak output voltage swing	$I_O = 200 \mu A$	25°C	-3.8 -4.2			-3.8 -4.2			V	
		Full range	-3.7			-3.7				
	$I_O = 2 \text{ mA}$	25°C	-3.5 -4.1			-3.5 -4.1				
		Full range	-3.4			-3.4				
	$I_O = 20 \text{ mA}$	25°C	-1.5 -2.4			-1.5 -2.4				
		Full range	-1.5			-1.5				
$A_{VD}$ Large-signal differential voltage amplification	$V_O = \pm 2.3 \text{ V}$	$R_L = 600 \Omega$	25°C	80 91			80 91			dB
			Full range	79			79			
		$R_L = 2 \text{ k}\Omega$	25°C	90 100			90 100			
			Full range	89			89			
		$R_L = 10 \text{ k}\Omega$	25°C	95 106			95 106			
			Full range	94			94			
$r_i$ Input resistance	$V_{IC} = 0$	25°C	$10^{12}$			$10^{12}$			$\Omega$	
$c_i$ Input capacitance	$V_{IC} = 0, \text{ See Figure 5}$	Common mode	25°C	11			11			pF
		Differential	25°C	2.5			2.5			
$z_o$ Open-loop output impedance	$f = 1 \text{ MHz}$	25°C	80			80			$\Omega$	
CMRR Common-mode rejection ratio	$V_{IC} = V_{ICRmin}, V_O = 0, R_S = 50 \Omega$	25°C	70 89			70 89			dB	
		Full range	68			68				
$k_{SVR}$ Supply-voltage rejection ratio ( $\Delta V_{CC\pm} / \Delta V_{IO}$ )	$V_{CC\pm} = \pm 5 \text{ V to } \pm 15 \text{ V}, V_O = 0, R_S = 50 \Omega$	25°C	82 99			82 99			dB	
		Full range	80			80				

† Full range is 0°C to 70°C.

**TLE207x, TLE207xA, TLE207xY**  
**EXCALIBUR LOW-NOISE HIGH-SPEED**  
**JFET-INPUT OPERATIONAL AMPLIFIERS**

SLOS181A – FEBRUARY 1997 – REVISED MARCH 2000

**TLE2072C electrical characteristics at specified free-air temperature,  $V_{CC\pm} = \pm 5$  V (unless otherwise noted)**  
**(continued)**

PARAMETER	TEST CONDITIONS	T <sub>A</sub>	TLE2072C			TLE2072AC			UNIT
			MIN	TYP	MAX	MIN	TYP	MAX	
I <sub>CC</sub>	Supply current (both channels) V <sub>O</sub> = 0, No load	25°C	2.7	2.9	3.9	2.7	2.9	3.9	mA
		Full range	3.9			3.9			
a <sub>x</sub>	Crosstalk attenuation V <sub>IC</sub> = 0, R <sub>L</sub> = 2 kΩ	25°C	120			120			dB
I <sub>OS</sub>	Short-circuit output current V <sub>O</sub> = 0	25°C	V <sub>ID</sub> = 1 V			-35			mA
			V <sub>ID</sub> = -1 V			45			

**TLE2072C operating characteristics at specified free-air temperature,  $V_{CC\pm} = \pm 5$  V**

PARAMETER	TEST CONDITIONS	T <sub>A</sub> †	TLE2072C			TLE2072AC			UNIT
			MIN	TYP	MAX	MIN	TYP	MAX	
SR+	Positive slew rate V <sub>O</sub> (PP) = ±2.3 V, A <sub>VD</sub> = -1, R <sub>L</sub> = 2 kΩ, C <sub>L</sub> = 100 pF, See Figure 1	25°C	35			35			V/μs
		Full range	22			22			
SR-	Negative slew rate	25°C	38			38			V/μs
		Full range	22			22			
t <sub>s</sub>	Settling time A <sub>VD</sub> = -1, 2-V step, R <sub>L</sub> = 1 kΩ, C <sub>L</sub> = 100 pF	25°C	To 10 mV			0.25			μs
			To 1 mV			0.4			
V <sub>n</sub>	Equivalent input noise voltage R <sub>S</sub> = 20 Ω, See Figure 3	25°C	f = 10 Hz			28 55			nV/√Hz
			f = 10 kHz			11.6 17			
V <sub>N</sub> (PP)	Peak-to-peak equivalent input noise voltage	25°C	f = 10 Hz to 10 kHz			6			μV
			f = 0.1 Hz to 10 Hz			0.6			
I <sub>n</sub>	Equivalent input noise current V <sub>IC</sub> = 0, f = 10 kHz	25°C	2.8			2.8			fA/√Hz
THD + N	Total harmonic distortion plus noise V <sub>O</sub> (PP) = 5 V, f = 1 kHz, R <sub>S</sub> = 25 Ω, A <sub>VD</sub> = 10, R <sub>L</sub> = 2 kΩ	25°C	0.013%			0.013%			
B <sub>1</sub>	Unity-gain bandwidth V <sub>I</sub> = 10 mV, C <sub>L</sub> = 25 pF, R <sub>L</sub> = 2 kΩ, See Figure 2	25°C	9.4			9.4			MHz
B <sub>OM</sub>	Maximum output-swing bandwidth V <sub>O</sub> (PP) = 4 V, R <sub>L</sub> = 2 kΩ, A <sub>VD</sub> = -1, C <sub>L</sub> = 25 pF	25°C	2.8			2.8			MHz
φ <sub>m</sub>	Phase margin at unity gain V <sub>I</sub> = 10 mV, C <sub>L</sub> = 25 pF, R <sub>L</sub> = 2 kΩ, See Figure 2	25°C	56°			56°			

† Full range is 0°C to 70°C.



**TLE207x, TLE207xA, TLE207xY**  
**EXCALIBUR LOW-NOISE HIGH-SPEED**  
**JFET-INPUT OPERATIONAL AMPLIFIERS**  
SLOS181A – FEBRUARY 1997 – REVISED MARCH 2000

**TLE2072C electrical characteristics at specified free-air temperature,  $V_{CC\pm} = \pm 15$  V (unless otherwise noted)**

PARAMETER	TEST CONDITIONS	$T_A$ †	TLE2072C			TLE2072AC			UNIT	
			MIN	TYP	MAX	MIN	TYP	MAX		
$V_{IO}$ Input offset voltage	$V_{IC} = 0, V_O = 0, R_S = 50 \Omega$	25°C	1.1	6		0.7	3.5	mV		
		Full range			7.8		5.3			
$\alpha_{VIO}$ Temperature coefficient of input offset voltage		Full range	2.4	25		2.4	25	$\mu\text{V}/^\circ\text{C}$		
$I_{IO}$ Input offset current	$V_{IC} = 0, V_O = 0, \text{See Figure 4}$	25°C	6	100		6	100	pA		
		Full range			1.4		1.4	nA		
$I_{IB}$ Input bias current		25°C	20	175		20	175	pA		
		Full range			5		5	nA		
$V_{ICR}$ Common-mode input voltage range	$R_S = 50 \Omega$	25°C	15 to -11	15 to -11.9		15 to -11	15 to -11.9	V		
		Full range	15 to -10.9			15 to -10.9				
$V_{OM+}$ Maximum positive peak output voltage swing	$I_O = -200 \mu\text{A}$	25°C	13.8	14.1		13.8	14.1	V		
		Full range	13.6			13.6				
	$I_O = -2 \text{ mA}$	25°C	13.5	13.9		13.5	13.9			
		Full range	13.4			13.4				
	$I_O = -20 \text{ mA}$	25°C	11.5	12.3		11.5	12.3			
		Full range	11.5			11.5				
$V_{OM-}$ Maximum negative peak output voltage swing	$I_O = 200 \mu\text{A}$	25°C	-13.8	-14.2		-13.8	-14.2	V		
		Full range	-13.7			-13.7				
	$I_O = 2 \text{ mA}$	25°C	-13.5	-14		-13.5	-14			
		Full range	-13.4			-13.4				
	$I_O = 20 \text{ mA}$	25°C	-11.5	-12.4		-11.5	-12.4			
		Full range	-11.5			-11.5				
$A_{VD}$ Large-signal differential voltage amplification	$V_O = \pm 10 \text{ V}$	$R_L = 600 \Omega$	25°C	80	96		80	96	dB	
			Full range	79			79			
		$R_L = 2 \text{ k}\Omega$	25°C	90	109		90	109		
			Full range	89			89			
		$R_L = 10 \text{ k}\Omega$	25°C	95	118		95	118		
			Full range	94			94			
$r_i$ Input resistance	$V_{IC} = 0$	25°C	$10^{12}$			$10^{12}$			$\Omega$	
$c_i$ Input capacitance	$V_{IC} = 0, \text{See Figure 5}$	Common mode	25°C	7.5			7.5			pF
		Differential	25°C	2.5			2.5			
$z_o$ Open-loop output impedance	$f = 1 \text{ MHz}$	25°C	80			80			$\Omega$	
CMRR Common-mode rejection ratio	$V_{IC} = V_{ICRmin}, V_O = 0, R_S = 50 \Omega$	25°C	80	98		80	98	dB		
		Full range	79			79				
$k_{SVR}$ Supply-voltage rejection ratio ( $\Delta V_{CC\pm}/\Delta V_{IO}$ )	$V_{CC\pm} = \pm 5 \text{ V to } \pm 15 \text{ V}, V_O = 0, R_S = 50 \Omega$	25°C	82	99		82	99	dB		
		Full range	81			81				

† Full range is 0°C to 70°C.

**TLE207x, TLE207xA, TLE207xY**  
**EXCALIBUR LOW-NOISE HIGH-SPEED**  
**JFET-INPUT OPERATIONAL AMPLIFIERS**

SLOS181A – FEBRUARY 1997 – REVISED MARCH 2000

**TLE2072C electrical characteristics at specified free-air temperature,  $V_{CC\pm} = \pm 15\text{ V}$  (unless otherwise noted) (continued)**

PARAMETER	TEST CONDITIONS	$T_A$	TLE2072C			TLE2072AC			UNIT	
			MIN	TYP	MAX	MIN	TYP	MAX		
$I_{CC}$	Supply current (both channels)	$V_O = 0$ , No load	25°C	2.7	3.1	3.9	2.7	3.1	3.9	mA
			Full range	3.9			3.9			
$a_x$	Crosstalk attenuation	$V_{IC} = 0$ , $R_L = 2\text{ k}\Omega$	25°C	120			120			dB
$I_{OS}$	Short-circuit output current	$V_O = 0$	25°C	$V_{ID} = 1\text{ V}$		-30		-45		mA
				$V_{ID} = -1\text{ V}$		30		48		

**TLE2072C operating characteristics at specified free-air temperature,  $V_{CC\pm} = \pm 15\text{ V}$**

PARAMETER	TEST CONDITIONS	$T_A$ †	TLE2072C			TLE2072AC			UNIT	
			MIN	TYP	MAX	MIN	TYP	MAX		
SR+	Positive slew rate	$V_{O(PP)} = 10\text{ V}$ , $A_{VD} = -1$ , $C_L = 100\text{ pF}$ , $R_L = 2\text{ k}\Omega$ , See Figure 1	25°C	28	40		28	40	V/ $\mu$ s	
			Full range	25			25			
SR-	Negative slew rate		25°C	30	45		30	45	V/ $\mu$ s	
			Full range	25			25			
$t_s$	Settling time	$A_{VD} = -1$ , 10-V step, $R_L = 1\text{ k}\Omega$ , $C_L = 100\text{ pF}$	25°C	To 10 mV		0.4		0.4		$\mu$ s
				To 1 mV		1.5		1.5		
$V_n$	Equivalent input noise voltage	$R_S = 20\ \Omega$ , See Figure 3	25°C	f = 10 Hz	28	55	28	55	nV/ $\sqrt{\text{Hz}}$	
				f = 10 kHz	11.6	17	11.6	17		
$V_{N(PP)}$	Peak-to-peak equivalent input noise voltage		25°C	f = 10 Hz to 10 kHz		6		6		$\mu$ V
				f = 0.1 Hz to 10 Hz		0.6		0.6		
$I_n$	Equivalent input noise current	$V_{IC} = 0$ , f = 10 kHz	25°C	2.8			2.8			fA/ $\sqrt{\text{Hz}}$
THD + N	Total harmonic distortion plus noise	$V_{O(PP)} = 20\text{ V}$ , f = 1 kHz, $R_S = 25\ \Omega$	25°C	0.008%			0.008%			
$B_1$	Unity-gain bandwidth	$V_I = 10\text{ mV}$ , $C_L = 25\text{ pF}$ , $R_L = 2\text{ k}\Omega$ , See Figure 2	25°C	8	10		8	10	MHz	
BOM	Maximum output-swing bandwidth	$V_{O(PP)} = 20\text{ V}$ , $R_L = 2\text{ k}\Omega$ , $A_{VD} = -1$ , $C_L = 25\text{ pF}$	25°C	478	637		478	637	kHz	
$\phi_m$	Phase margin at unity gain	$V_I = 10\text{ mV}$ , $C_L = 25\text{ pF}$ , $R_L = 2\text{ k}\Omega$ , See Figure 2	25°C	57°			57°			

† Full range is 0°C to 70°C.

**TLE207x, TLE207xA, TLE207xY**  
**EXCALIBUR LOW-NOISE HIGH-SPEED**  
**JFET-INPUT OPERATIONAL AMPLIFIERS**  
 SLOS181A – FEBRUARY 1997 – REVISED MARCH 2000

**TLE2072I electrical characteristics at specified free-air temperature,  $V_{CC\pm} = \pm 5$  V (unless otherwise noted)**

PARAMETER	TEST CONDITIONS	$T_A$ †	TLE2072I			TLE2072AI			UNIT	
			MIN	TYP	MAX	MIN	TYP	MAX		
$V_{IO}$ Input offset voltage	$V_{IC} = 0, V_O = 0, R_S = 50 \Omega$	25°C	0.9 6			0.65 3.5			mV	
		Full range	9.1			6.4				
$\alpha_{VIO}$ Temperature coefficient of input offset voltage		Full range	2.4 25			2.4 25			$\mu V/^\circ C$	
$I_{IO}$ Input offset current	$V_{IC} = 0, V_O = 0, \text{See Figure 4}$	25°C	5 100			5 100			pA	
		Full range	5			5			nA	
$I_{IB}$ Input bias current		25°C	15 175			15 175			pA	
		Full range	10			10			nA	
$V_{ICR}$ Common-mode input voltage range	$R_S = 50 \Omega$	25°C	5 to -1 to -1.9			5 to -1 to -1.9			V	
		Full range	5 to -0.8			5 to -0.8				
$V_{OM+}$ Maximum positive peak output voltage swing	$I_O = -200 \mu A$	25°C	3.8 4.1			3.8 4.1			V	
		Full range	3.7			3.7				
	$I_O = -2 \text{ mA}$	25°C	3.5 3.9			3.5 3.9				
		Full range	3.4			3.4				
	$I_O = -20 \text{ mA}$	25°C	1.5 2.3			1.5 2.3				
		Full range	1.5			1.5				
$V_{OM-}$ Maximum negative peak output voltage swing	$I_O = 200 \mu A$	25°C	-3.8 -4.2			-3.8 -4.2			V	
		Full range	-3.7			-3.7				
	$I_O = 2 \text{ mA}$	25°C	-3.5 -4.1			-3.5 -4.1				
		Full range	-3.4			-3.4				
	$I_O = 20 \text{ mA}$	25°C	-1.5 -2.4			-1.5 -2.4				
		Full range	-1.5			-1.5				
$A_{VD}$ Large-signal differential voltage amplification	$V_O = \pm 2.3 \text{ V}$	$R_L = 600 \Omega$	25°C	80 91			80 91			dB
			Full range	79			79			
		$R_L = 2 \text{ k}\Omega$	25°C	90 100			90 100			
			Full range	89			89			
		$R_L = 10 \text{ k}\Omega$	25°C	95 106			95 106			
			Full range	94			94			
$r_i$ Input resistance	$V_{IC} = 0$	25°C	$10^{12}$			$10^{12}$			$\Omega$	
$c_i$ Input capacitance	$V_{IC} = 0, \text{See Figure 5}$	Common mode	25°C	11			11			pF
		Differential	25°C	2.5			2.5			
$z_o$ Open-loop output impedance	$f = 1 \text{ MHz}$	25°C	80			80			$\Omega$	
CMRR Common-mode rejection ratio	$V_{IC} = V_{ICRmin}, V_O = 0, R_S = 50 \Omega$	25°C	70 89			70 89			dB	
		Full range	68			68				
$k_{SVR}$ Supply-voltage rejection ratio ( $\Delta V_{CC\pm}/\Delta V_{IO}$ )	$V_{CC\pm} = \pm 5 \text{ V to } \pm 15 \text{ V}, V_O = 0, R_S = 50 \Omega$	25°C	82 99			82 99			dB	
		Full range	80			80				

† Full range is  $-40^\circ C$  to  $85^\circ C$ .

**TLE207x, TLE207xA, TLE207xY**  
**EXCALIBUR LOW-NOISE HIGH-SPEED**  
**JFET-INPUT OPERATIONAL AMPLIFIERS**

SLOS181A – FEBRUARY 1997 – REVISED MARCH 2000

**TLE2072I electrical characteristics at specified free-air temperature,  $V_{CC\pm} = \pm 5\text{ V}$  (unless otherwise noted) (continued)**

PARAMETER	TEST CONDITIONS	T <sub>A</sub>	TLE2072I			TLE2072AI			UNIT	
			MIN	TYP	MAX	MIN	TYP	MAX		
I <sub>CC</sub>	Supply current (both channels)	V <sub>O</sub> = 0, No load	25°C	2.7	2.9	3.9	2.7	2.9	3.9	mA
			Full range			3.9			3.9	
a <sub>x</sub>	Crosstalk attenuation	V <sub>IC</sub> = 0, R <sub>L</sub> = 2 kΩ	25°C	120			120			dB
I <sub>OS</sub>	Short-circuit output current	V <sub>O</sub> = 0	25°C	V <sub>ID</sub> = 1 V			-35			mA
				V <sub>ID</sub> = -1 V			45			

**TLE2072I operating characteristics at specified free-air temperature,  $V_{CC\pm} = \pm 5\text{ V}$**

PARAMETER	TEST CONDITIONS	T <sub>A</sub> †	TLE2072I			TLE2072AI			UNIT	
			MIN	TYP	MAX	MIN	TYP	MAX		
SR+	Positive slew rate	V <sub>O(PP)</sub> = ±2.3 V, A <sub>VD</sub> = -1, R <sub>L</sub> = 2 kΩ, C <sub>L</sub> = 100 pF, See Figure 1	25°C	35			35			V/μs
			Full range	20			20			
SR-	Negative slew rate	V <sub>O(PP)</sub> = ±2.3 V, A <sub>VD</sub> = -1, R <sub>L</sub> = 2 kΩ, C <sub>L</sub> = 100 pF, See Figure 1	25°C	38			38			V/μs
			Full range	20			20			
t <sub>s</sub>	Settling time	A <sub>VD</sub> = -1, 2-V step, R <sub>L</sub> = 1 kΩ, C <sub>L</sub> = 100 pF	25°C	To 10 mV			0.25			μs
				To 1 mV			0.4			
V <sub>n</sub>	Equivalent input noise voltage	R <sub>S</sub> = 20 Ω, See Figure 3	25°C	f = 10 Hz			28			nV/√Hz
				f = 10 kHz			11.6			
V <sub>N(PP)</sub>	Peak-to-peak equivalent input noise voltage	R <sub>S</sub> = 20 Ω, See Figure 3	25°C	f = 10 Hz to 10 kHz			6			μV
				f = 0.1 Hz to 10 Hz			0.6			
I <sub>n</sub>	Equivalent input noise current	V <sub>IC</sub> = 0, f = 10 kHz	25°C	2.8			2.8			fA/√Hz
THD + N	Total harmonic distortion plus noise	V <sub>O(PP)</sub> = 5 V, f = 1 kHz, R <sub>S</sub> = 25 Ω	25°C	0.013%			0.013%			
B <sub>1</sub>	Unity-gain bandwidth	V <sub>I</sub> = 10 mV, C <sub>L</sub> = 25 pF, R <sub>L</sub> = 2 kΩ, See Figure 2	25°C	9.4			9.4			MHz
B <sub>OM</sub>	Maximum output-swing bandwidth	V <sub>O(PP)</sub> = 4 V, R <sub>L</sub> = 2 kΩ, A <sub>VD</sub> = -1, C <sub>L</sub> = 25 pF	25°C	2.8			2.8			MHz
φ <sub>m</sub>	Phase margin at unity gain	V <sub>I</sub> = 10 mV, C <sub>L</sub> = 25 pF, R <sub>L</sub> = 2 kΩ, See Figure 2	25°C	56°			56°			

† Full range is 40°C to 85°C.

**TLE207x, TLE207xA, TLE207xY**  
**EXCALIBUR LOW-NOISE HIGH-SPEED**  
**JFET-INPUT OPERATIONAL AMPLIFIERS**  
 SLOS181A – FEBRUARY 1997 – REVISED MARCH 2000

**TLE2072I electrical characteristics at specified free-air temperature,  $V_{CC\pm} = \pm 15$  V (unless otherwise noted)**

PARAMETER	TEST CONDITIONS	$T_A$ †	TLE2072I			TLE2072AI			UNIT	
			MIN	TYP	MAX	MIN	TYP	MAX		
$V_{IO}$ Input offset voltage	$V_{IC} = 0, V_O = 0, R_S = 50 \Omega$	25°C	1.1 6			0.7 3.5			mV	
		Full range				6.4				
$\alpha_{VIO}$ Temperature coefficient of input offset voltage		Full range	2.4 25			2.4 25			$\mu V/^\circ C$	
$I_{IO}$ Input offset current	$V_{IC} = 0, V_O = 0, \text{See Figure 4}$	25°C	6 100			6 100			pA	
		Full range				5			nA	
$I_{IB}$ Input bias current		25°C	20 175			20 175			pA	
		Full range				10			nA	
$V_{ICR}$ Common-mode input voltage range	$R_S = 50 \Omega$	25°C	15 to -11.9			15 to -11.9			V	
		Full range	15 to -10.8			15 to -10.8				
$V_{OM+}$ Maximum positive peak output voltage swing	$I_O = -200 \mu A$	25°C	13.8 14.1			13.8 14.1			V	
		Full range	13.7			13.7				
	$I_O = -2 \text{ mA}$	25°C	13.5 13.9			13.5 13.9				
		Full range	13.4			13.4				
	$I_O = -20 \text{ mA}$	25°C	11.5 12.3			11.5 12.3				
		Full range	11.5			11.5				
$V_{OM-}$ Maximum negative peak output voltage swing	$I_O = 200 \mu A$	25°C	-13.8 -14.2			-13.8 -14.2			V	
		Full range	-13.7			-13.7				
	$I_O = 2 \text{ mA}$	25°C	-13.5 -14			-13.5 -14				
		Full range	-13.4			-13.4				
	$I_O = 20 \text{ mA}$	25°C	-11.5 -12.4			-11.5 -12.4				
		Full range	-11.5			-11.5				
$A_{VD}$ Large-signal differential voltage amplification	$V_O = \pm 10 \text{ V}$	$R_L = 600 \Omega$	25°C	80 96			80 96			dB
			Full range	79			79			
		$R_L = 2 \text{ k}\Omega$	25°C	90 109			90 109			
			Full range	89			89			
		$R_L = 10 \text{ k}\Omega$	25°C	95 118			95 118			
			Full range	94			94			
$r_i$ Input resistance	$V_{IC} = 0$	25°C	$10^{12}$			$10^{12}$			$\Omega$	
$c_i$ Input capacitance	$V_{IC} = 0, \text{See Figure 5}$	Common mode	25°C	7.5			7.5			pF
		Differential	25°C	2.5			2.5			
$z_o$ Open-loop output impedance	$f = 1 \text{ MHz}$	25°C	80			80			$\Omega$	
CMRR Common-mode rejection ratio	$V_{IC} = V_{ICRmin}, V_O = 0, R_S = 50 \Omega$	25°C	80 98			80 98			dB	
		Full range	79			79				
$k_{SVR}$ Supply-voltage rejection ratio ( $\Delta V_{CC\pm}/\Delta V_{IO}$ )	$V_{CC\pm} = \pm 5 \text{ V to } \pm 15 \text{ V}, V_O = 0, R_S = 50 \Omega$	25°C	82 99			82 99			dB	
		Full range	80			80				

† Full range is  $-40^\circ C$  to  $85^\circ C$ .

**TLE207x, TLE207xA, TLE207xY**  
**EXCALIBUR LOW-NOISE HIGH-SPEED**  
**JFET-INPUT OPERATIONAL AMPLIFIERS**

SLOS181A – FEBRUARY 1997 – REVISED MARCH 2000

**TLE2072I electrical characteristics at specified free-air temperature,  $V_{CC\pm} = \pm 15$  V (unless otherwise noted)**  
**(continued)**

PARAMETER	TEST CONDITIONS	T <sub>A</sub>	TLE2072I			TLE2072AI			UNIT
			MIN	TYP	MAX	MIN	TYP	MAX	
I <sub>CC</sub>	Supply current (both channels) V <sub>O</sub> = 0, No load	25°C	2.7	3.1	3.9	2.7	3.1	3.9	mA
		Full range	3.9			3.9			
a <sub>x</sub>	Crosstalk attenuation V <sub>IC</sub> = 0, R <sub>L</sub> = 2 kΩ	25°C	120			120			dB
I <sub>OS</sub>	Short-circuit output current V <sub>O</sub> = 0	25°C	V <sub>ID</sub> = 1 V		-30 -45		-30 -45		mA
			V <sub>ID</sub> = -1 V		30 48		30 48		

**TLE2072I operating characteristics at specified free-air temperature,  $V_{CC\pm} = \pm 15$  V**

PARAMETER	TEST CONDITIONS	T <sub>A</sub> †	TLE2072I			TLE2072AI			UNIT
			MIN	TYP	MAX	MIN	TYP	MAX	
SR+	Positive slew rate V <sub>O(PP)</sub> = ±10 V, A <sub>VD</sub> = -1, C <sub>L</sub> = 100 pF, R <sub>L</sub> = 2 kΩ, See Figure 1	25°C	28	40		28	40		V/μs
		Full range	22			22			
SR-	Negative slew rate	25°C	30	45		30	45		V/μs
		Full range	22			22			
t <sub>s</sub>	Settling time A <sub>VD</sub> = -1, 10-V step, R <sub>L</sub> = 1 kΩ, C <sub>L</sub> = 100 pF	25°C	To 10 mV		0.4		0.4		μs
			To 1 mV		1.5		1.5		
V <sub>n</sub>	Equivalent input noise voltage	25°C	f = 10 Hz	28	55	28	55	nV/√Hz	
			f = 10 kHz	11.6	17	11.6	17		
V <sub>N(PP)</sub>	Peak-to-peak equivalent input noise voltage R <sub>S</sub> = 20 Ω, See Figure 3	25°C	f = 0 Hz to 10 kHz		6		6		μV
			f = 0.1 Hz to 10 Hz		0.6		0.6		
I <sub>n</sub>	Equivalent input noise current V <sub>IC</sub> = 0, f = 10 kHz	25°C	2.8			2.8			fA/√Hz
THD + N	Total harmonic distortion plus noise V <sub>O(PP)</sub> = 20 V, f = 1 kHz, R <sub>S</sub> = 25 Ω, A <sub>VD</sub> = 10, R <sub>L</sub> = 2 kΩ	25°C	0.008%			0.008%			
B <sub>1</sub>	Unity-gain bandwidth V <sub>I</sub> = 10 mV, C <sub>L</sub> = 25 pF, R <sub>L</sub> = 2 kΩ, See Figure 2	25°C	8	10		8	10	MHz	
B <sub>OM</sub>	Maximum output-swing bandwidth V <sub>O(PP)</sub> = 20 V, A <sub>VD</sub> = -1, R <sub>L</sub> = 2 kΩ, C <sub>L</sub> = 25 pF	25°C	478	637		478	637	kHz	
φ <sub>m</sub>	Phase margin at unity gain V <sub>I</sub> = 10 mV, C <sub>L</sub> = 25 pF, R <sub>L</sub> = 2 kΩ, See Figure 2	25°C	57°			57°			

† Full range is -40°C to 85°C.

**TLE207x, TLE207xA, TLE207xY**  
**EXCALIBUR LOW-NOISE HIGH-SPEED**  
**JFET-INPUT OPERATIONAL AMPLIFIERS**  
SLOS181A – FEBRUARY 1997 – REVISED MARCH 2000

**TLE2072M electrical characteristics at specified free-air temperature,  $V_{CC\pm} = \pm 5$  V (unless otherwise noted)**

PARAMETER	TEST CONDITIONS	$T_A$ †	TLE2072M			TLE2072AM			UNIT	
			MIN	TYP	MAX	MIN	TYP	MAX		
$V_{IO}$ Input offset voltage	$V_{IC} = 0, V_O = 0,$ $R_S = 50 \Omega,$	25°C	0.9 6			0.65 3.5			mV	
		Full range	10.5			8				
$\alpha_{VIO}$ Temperature coefficient of input offset voltage		Full range	2.3 25*			2.3 25*			$\mu V/^\circ C$	
$I_{IO}$ Input offset current	$V_{IC} = 0, V_O = 0,$ See Figure 4	25°C	5 100			5 100			pA	
		Full range	20			20			nA	
$I_{IB}$ Input bias current		25°C	15 175			15 175			pA	
		Full range	60			60			nA	
$V_{ICR}$ Common-mode input voltage range	$R_S = 50 \Omega$	25°C	5 to -1 5 to -1.9			5 to -1 5 to -1.9			V	
		Full range	5 to -0.8			5 to -0.8				
$V_{OM+}$ Maximum positive peak output voltage swing	$I_O = -200 \mu A$	25°C	3.8 4.1			3.8 4.1			V	
		Full range	3.6			3.6				
	$I_O = -2$ mA	25°C	3.5 3.9			3.5 3.9				
		Full range	3.3			3.3				
	$I_O = -20$ mA	25°C	1.5 2.3			1.5 2.3				
		Full range	1.4			1.4				
$V_{OM-}$ Maximum negative peak output voltage swing	$I_O = 200 \mu A$	25°C	-3.8 -4.2			-3.8 -4.2			V	
		Full range	-3.6			-3.6				
	$I_O = 2$ mA	25°C	-3.5 -4.1			-3.5 -4.1				
		Full range	-3.3			-3.3				
	$I_O = 20$ mA	25°C	-1.5 -2.4			-1.5 -2.4				
		Full range	-1.4			-1.4				
$A_{VD}$ Large-signal differential voltage amplification	$V_O = \pm 2.3$ V	$R_L = 600 \Omega$	25°C	80 91			80 91			dB
			Full range	78			78			
		$R_L = 2$ k $\Omega$	25°C	90 100			90 100			
			Full range	88			88			
		$R_L = 10$ k $\Omega$	25°C	95 106			95 106			
			Full range	93			93			
$r_i$ Input resistance	$V_{IC} = 0$	25°C	$10^{12}$			$10^{12}$			$\Omega$	
$c_i$ Input capacitance	$V_{IC} = 0,$ See Figure 5	Common mode	25°C	11			11			pF
		Differential	25°C	2.5			2.5			
$z_o$ Open-loop output impedance	$f = 1$ MHz	25°C	80			80			$\Omega$	
CMRR Common-mode rejection ratio	$V_{IC} = V_{ICRmin},$ $V_O = 0,$ $R_S = 50 \Omega$	25°C	70 89			70 89			dB	
		Full range	68			68				

\*On products compliant to MIL-PRF-38535, Class B, this parameter is not production tested.

† Full range is  $-55^\circ C$  to  $125^\circ C$ .

**TLE207x, TLE207xA, TLE207xY**  
**EXCALIBUR LOW-NOISE HIGH-SPEED**  
**JFET-INPUT OPERATIONAL AMPLIFIERS**

SLOS181A – FEBRUARY 1997 – REVISED MARCH 2000

**TLE2072M electrical characteristics at specified free-air temperature,  $V_{CC\pm} = \pm 5\text{ V}$  (unless otherwise noted) (continued)**

PARAMETER	TEST CONDITIONS	$T_A^\dagger$	TLE2072M			TLE2072AM			UNIT	
			MIN	TYP	MAX	MIN	TYP	MAX		
$k_{SVR}$	Supply-voltage rejection ratio ( $\Delta V_{CC\pm} / \Delta V_{IO}$ )	$V_{CC\pm} = \pm 5\text{ V}$ to $\pm 15\text{ V}$ , $V_O = 0$ , $R_S = 50\ \Omega$	Full range	80			80			dB
$I_{CC}$	Supply current (both channels)	$V_O = 0$ , No load	25°C	2.7	2.9	3.6	2.7	2.9	3.6	mA
			Full range			3.6			3.6	
$a_x$	Crosstalk attenuation	$V_{IC} = 0$ , $R_L = 2\text{ k}\Omega$	25°C		120			120		dB
$I_{OS}$	Short-circuit output current	$V_O = 0$	25°C	$V_{ID} = 1\text{ V}$			$-35$			mA
				$V_{ID} = -1\text{ V}$			45			

$^\dagger$  Full range is  $-55^\circ\text{C}$  to  $125^\circ\text{C}$ .

**TLE2072M operating characteristics at specified free-air temperature,  $V_{CC\pm} = \pm 5\text{ V}$**

PARAMETER	TEST CONDITIONS	$T_A^\dagger$	TLE2072M			TLE2072AM			UNIT		
			MIN	TYP	MAX	MIN	TYP	MAX			
SR+	Positive slew rate	$V_{O(PP)} = \pm 2.3\text{ V}$ , $A_{VD} = -1$ , $C_L = 100\text{ pF}$ , $R_L = 2\text{ k}\Omega$ , See Figure 1	25°C		35			35	V/ $\mu\text{s}$		
			Full range	18*			18*				
SR-	Negative slew rate	$V_{O(PP)} = \pm 2.3\text{ V}$ , $A_{VD} = -1$ , $C_L = 100\text{ pF}$ , $R_L = 2\text{ k}\Omega$ , See Figure 1	25°C		38			38	V/ $\mu\text{s}$		
			Full range	18*			18*				
$t_s$	Settling time	$A_{VD} = -1$ , 2-V step, $R_L = 1\text{ k}\Omega$ , $C_L = 100\text{ pF}$	To 10 mV	25°C		0.25			0.25	$\mu\text{s}$	
			To 1 mV			0.4			0.4		
$V_n$	Equivalent input noise voltage	$R_S = 20\ \Omega$ , See Figure 3	f = 10 Hz	25°C		28	55*		28	55*	nV/ $\sqrt{\text{Hz}}$
			f = 10 kHz			11.6	17*		11.6	17*	
$V_{N(PP)}$	Peak-to-peak equivalent input noise voltage	$R_S = 20\ \Omega$ , See Figure 3	f = 10 Hz to 10 kHz	25°C		6			6	$\mu\text{V}$	
			f = 0.1 Hz to 10 Hz			0.6			0.6		
$I_n$	Equivalent input noise current	$V_{IC} = 0$ , f = 10 kHz	25°C		2.8			2.8	fA/ $\sqrt{\text{Hz}}$		
THD + N	Total harmonic distortion plus noise	$V_{O(PP)} = 5\text{ V}$ , f = 1 kHz, $R_S = 25\ \Omega$	25°C		0.013%			0.013%			
$B_1$	Unity-gain bandwidth	$V_I = 10\text{ mV}$ , $C_L = 25\text{ pF}$ , $R_L = 2\text{ k}\Omega$ , See Figure 2	25°C		9.4			9.4	MHz		
BOM	Maximum output-swing bandwidth	$V_{O(PP)} = 4\text{ V}$ , $R_L = 2\text{ k}\Omega$ , $A_{VD} = -1$ , $C_L = 25\text{ pF}$	25°C		2.8			2.8	MHz		
$\phi_m$	Phase margin at unity gain	$V_I = 10\text{ mV}$ , $C_L = 25\text{ pF}$ , $R_L = 2\text{ k}\Omega$ , See Figure 2	25°C		56°			56°			

\*On products compliant to MIL-PRF-38535, Class B, this parameter is not production tested.

$^\dagger$  Full range is  $-55^\circ\text{C}$  to  $125^\circ\text{C}$ .



**TLE207x, TLE207xA, TLE207xY**  
**EXCALIBUR LOW-NOISE HIGH-SPEED**  
**JFET-INPUT OPERATIONAL AMPLIFIERS**  
SLOS181A – FEBRUARY 1997 – REVISED MARCH 2000

**TLE2072M electrical characteristics at specified free-air temperature,  $V_{CC\pm} = \pm 15$  V (unless otherwise noted)**

PARAMETER	TEST CONDITIONS	$T_A$ †	TLE2072M			TLE2072AM			UNIT	
			MIN	TYP	MAX	MIN	TYP	MAX		
$V_{IO}$ Input offset voltage	$V_{IC} = 0, V_O = 0, R_S = 50 \Omega$	25°C	1.1 6			0.7 3.5			mV	
		Full range	10.5			8				
$\alpha_{VIO}$ Temperature coefficient of input offset voltage		Full range	2.4 25*			2.4 25*			$\mu V/^\circ C$	
$I_{IO}$ Input offset current	$V_{IC} = 0, V_O = 0, \text{See Figure 4}$	25°C	6 100			6 100			pA	
		Full range	20			20			nA	
$I_{IB}$ Input bias current		25°C	20 175			20 175			pA	
		Full range	60			60			nA	
$V_{ICR}$ Common-mode input voltage range	$R_S = 50 \Omega$	25°C	15 to -11 15 to -11.9			15 to -11 15 to -11.9			V	
		Full range	15 to -10.8			15 to -10.8				
$V_{OM+}$ Maximum positive peak output voltage swing	$I_O = -200 \mu A$	25°C	13.8 14.1			13.8 14.1			V	
		Full range	13.6			13.6				
	$I_O = -2 \text{ mA}$	25°C	13.5 13.9			13.5 13.9				
		Full range	13.3			13.3				
	$I_O = -20 \text{ mA}$	25°C	11.5 12.3			11.5 12.3				
		Full range	11.4			11.4				
$V_{OM-}$ Maximum negative peak output voltage swing	$I_O = 200 \mu A$	25°C	-13.8 -14.2			-13.8 -14.2			V	
		Full range	-13.6			-13.6				
	$I_O = 2 \text{ mA}$	25°C	-13.5 -14			-13.5 -14				
		Full range	-13.3			-13.3				
	$I_O = 20 \text{ mA}$	25°C	-11.5 -12.4			-11.5 -12.4				
		Full range	-11.4			-11.4				
$A_{VD}$ Large-signal differential voltage amplification	$V_O = \pm 10 \text{ V}$	$R_L = 600 \Omega$	25°C	80 96			80 96			dB
			Full range	78			78			
		$R_L = 2 \text{ k}\Omega$	25°C	90 109			90 109			
			Full range	89			89			
		$R_L = 10 \text{ k}\Omega$	25°C	95 118			95 118			
			Full range	93			93			
$r_i$ Input resistance	$V_{IC} = 0$	25°C	$10^{12}$			$10^{12}$			$\Omega$	
$c_i$ Input capacitance	$V_{IC} = 0, \text{See Figure 5}$	Common mode	25°C	7.5			7.5			pF
		Differential	25°C	2.5			2.5			
$z_o$ Open-loop output impedance	$f = 1 \text{ MHz}$	25°C	80			80			$\Omega$	
CMRR Common-mode rejection ratio	$V_{IC} = V_{ICRmin}, V_O = 0, R_S = 50 \Omega$	25°C	80 98			80 98			dB	
		Full range	78			78				
$k_{SVR}$ Supply-voltage rejection ratio ( $\Delta V_{CC\pm}/\Delta V_{IO}$ )	$V_{CC\pm} = \pm 5 \text{ V to } \pm 15 \text{ V}, V_O = 0, R_S = 50 \Omega$	25°C	82 99			82 99			dB	
		Full range	80			80				

\*On products compliant to MIL-PRF-38535, Class B, this parameter is not production tested.

† Full range is  $-55^\circ C$  to  $125^\circ C$ .

# TLE207x, TLE207xA, TLE207xY EXCALIBUR LOW-NOISE HIGH-SPEED JFET-INPUT OPERATIONAL AMPLIFIERS

SLOS181A – FEBRUARY 1997 – REVISED MARCH 2000

**TLE2072M electrical characteristics at specified free-air temperature,  $V_{CC\pm} = \pm 15$  V (unless otherwise noted)**

PARAMETER	TEST CONDITIONS	$T_A$ †	TLE2072M			TLE2072AM			UNIT
			MIN	TYP	MAX	MIN	TYP	MAX	
$I_{CC}$	Supply current (both channels) $V_O = 0$ , No load	25°C	2.7	3.1	3.6	2.7	3.1	3.6	mA
		Full range	3.6			3.6			
$a_x$	Crosstalk attenuation $V_{IC} = 0$ , $R_L = 2$ k $\Omega$	25°C	120			120			dB
$I_{OS}$	Short-circuit output current $V_O = 0$	25°C	$V_{ID} = 1$ V		-30	-45	-30	-45	mA
			$V_{ID} = -1$ V		30	48	30	48	

† Full range is  $-55^\circ\text{C}$  to  $125^\circ\text{C}$ .

**TLE2072M operating characteristics at specified free-air temperature,  $V_{CC\pm} = \pm 15$  V**

PARAMETER	TEST CONDITIONS	$T_A$ †	TLE2072M			TLE2072AM			UNIT
			MIN	TYP	MAX	MIN	TYP	MAX	
SR+	Positive slew rate $V_{O(PP)} = 10$ V, $A_{VD} = -1$ , $R_L = 2$ k $\Omega$ , $C_L = 100$ pF, See Figure 1	25°C	28	40		28	40		V/ $\mu$ s
		Full range	20			20			
SR-	Negative slew rate	25°C	30	45		30	45		V/ $\mu$ s
		Full range	20			20			
$t_s$	Settling time $A_{VD} = -1$ , 10-V step, $R_L = 1$ k $\Omega$ , $C_L = 100$ pF	25°C	To 10 mV		0.4		0.4		$\mu$ s
			To 1 mV		1.5		1.5		
$V_n$	Equivalent input noise voltage $R_S = 20$ $\Omega$ , See Figure 3	25°C	f = 10 Hz	28	55*	28	55*	nV/ $\sqrt{\text{Hz}}$	
			f = 10 kHz	11.6	17*	11.6	17*		
$V_{N(PP)}$	Peak-to-peak equivalent input noise voltage	25°C	f = 10 Hz to 10 kHz		6		6		$\mu$ V
			f = 0.1 Hz to 10 Hz		0.6		0.6		
$I_n$	Equivalent input noise current $V_{IC} = 0$ , f = 10 kHz	25°C	2.8			2.8			fA/ $\sqrt{\text{Hz}}$
THD + N	Total harmonic distortion plus noise $V_{O(PP)} = 20$ V, $A_{VD} = 10$ , f = 1 kHz, $R_L = 2$ k $\Omega$ , $R_S = 25$ $\Omega$	25°C	0.008%			0.008%			
$B_1$	Unity-gain bandwidth $V_I = 10$ mV, $R_L = 2$ k $\Omega$ , $C_L = 25$ pF, See Figure 2	25°C	8*	10		8*	10	MHz	
$B_{OM}$	Maximum output-swing bandwidth $V_{O(PP)} = 20$ V, $A_{VD} = -1$ , $R_L = 2$ k $\Omega$ , $C_L = 25$ pF	25°C	478*	637		478*	637	kHz	
$\phi_m$	Phase margin at unity gain $V_I = 10$ mV, $R_L = 2$ k $\Omega$ , $C_L = 25$ pF, See Figure 2	25°C	57°			57°			

\*On products compliant to MIL-PRF-38535, Class B, this parameter is not production tested.

† Full range is  $-55^\circ\text{C}$  to  $125^\circ\text{C}$ .

**TLE207x, TLE207xA, TLE207xY**  
**EXCALIBUR LOW-NOISE HIGH-SPEED**  
**JFET-INPUT OPERATIONAL AMPLIFIERS**

SLOS181A – FEBRUARY 1997 – REVISED MARCH 2000

**TLE2072Y electrical characteristics at  $V_{CC\pm} = \pm 15\text{ V}$ ,  $T_A = 25^\circ\text{C}$**

PARAMETER	TEST CONDITIONS	TLE2072Y			UNIT
		MIN	TYP	MAX	
$V_{IO}$ Input offset voltage	$V_{IC} = 0$ , $V_O = 0$ , $R_S = 50\ \Omega$		1.1	6	mV
$I_{IO}$ Input offset current	$V_{IC} = 0$ , $V_O = 0$ , See Figure 4		6	100	pA
$I_{IB}$ Input bias current			20	175	pA
$V_{ICR}$ Common-mode input voltage range	$R_S = 50\ \Omega$	15 to -11	15 to 11.9		V
$V_{OM+}$ Maximum positive peak output voltage swing	$I_O = -200\ \mu\text{A}$	13.8	14.1		V
	$I_O = -2\ \text{mA}$	13.5	13.9		
	$I_O = -20\ \text{mA}$	11.5	12.3		
$V_{OM-}$ Maximum negative peak output voltage swing	$I_O = 200\ \mu\text{A}$	-13.8	-14.2		V
	$I_O = 2\ \text{mA}$	-13.5	-14		
	$I_O = 20\ \text{mA}$	-11.5	-12.4		
$A_{VD}$ Large-signal differential voltage amplification	$V_O = \pm 10\ \text{V}$	$R_L = 600\ \Omega$	80	96	dB
		$R_L = 2\ \text{k}\Omega$	90	109	
		$R_L = 10\ \text{k}\Omega$	95	118	
$r_i$ Input resistance	$V_{IC} = 0$	10 <sup>12</sup>		$\Omega$	
$c_i$ Input capacitance	$V_{IC} = 0$ , See Figure 5	Common mode	7.5		pF
		Differential	2.5		
$z_o$ Open-loop output impedance	$f = 1\ \text{MHz}$	80		$\Omega$	
CMRR Common-mode rejection ratio	$V_{IC} = V_{ICRmin}$ , $V_O = 0$ , $R_S = 50\ \Omega$	80	98		dB
$k_{SVR}$ Supply-voltage rejection ratio ( $\Delta V_{CC\pm}/\Delta V_{IO}$ )	$V_{CC\pm} = \pm 5\ \text{V}$ to $\pm 15\ \text{V}$ , $V_O = 0$ , $R_S = 50\ \Omega$	82	99		dB
$I_{CC}$ Supply current (both channels)	$V_O = 0$ , No load	2.7	3.1	3.9	mA
$I_{OS}$ Short-circuit output current	$V_O = 0$	$V_{ID} = 1\ \text{V}$	-30	-45	mA
		$V_{ID} = -1\ \text{V}$	30	48	

# TLE207x, TLE207xA, TLE207xY EXCALIBUR LOW-NOISE HIGH-SPEED JFET-INPUT OPERATIONAL AMPLIFIERS

SLOS181A – FEBRUARY 1997 – REVISED MARCH 2000

**TLE2074C electrical characteristics at specified free-air temperature,  $V_{CC\pm} = \pm 5$  V (unless otherwise noted)**

PARAMETER	TEST CONDITIONS	$T_A$ †	TLE2074C			TLE2074AC			UNIT	
			MIN	TYP	MAX	MIN	TYP	MAX		
$V_{IO}$ Input offset voltage	$V_{IC} = 0, V_O = 0, R_S = 50 \Omega$	25°C	-1.6	5		-0.5	3	mV		
		Full range			7.1		5.1			
$\alpha_{VIO}$ Temperature coefficient of input offset voltage		Full range	10.1	30		10.1	30	$\mu V/^\circ C$		
$I_{IO}$ Input offset current	$V_{IC} = 0, V_O = 0, \text{See Figure 4}$	25°C	15	100		15	100	pA		
		Full range			1400		1400			
$I_{IB}$ Input bias current		25°C	20	175		20	175	pA		
		Full range			5000		5000			
$V_{ICR}$ Common-mode input voltage range	$R_S = 50 \Omega$	25°C	5 to -1	5 to -1.9		5 to -1	5 to -1.9	V		
		Full range	5 to -0.9			5 to -0.9				
$V_{OM+}$ Maximum positive peak output voltage swing	$I_O = -200 \mu A$	25°C	3.8	4.1		3.8	4.1	V		
		Full range	3.7			3.7				
	$I_O = -2 \text{ mA}$	25°C	3.5	3.9		3.5	3.9			
		Full range	3.4			3.4				
	$I_O = -20 \text{ mA}$	25°C	1.5	2.3		1.5	2.3			
		Full range	1.5			1.5				
$V_{OM-}$ Maximum negative peak output voltage swing	$I_O = 200 \mu A$	25°C	-3.8	-4.2		-3.8	-4.2	V		
		Full range	-3.7			-3.7				
	$I_O = 2 \text{ mA}$	25°C	-3.5	-4.1		-3.5	-4.1			
		Full range	-3.4			-3.4				
	$I_O = 20 \text{ mA}$	25°C	-1.5	-2.4		-1.5	-2.4			
		Full range	-1.5			-1.5				
$A_{VD}$ Large-signal differential voltage amplification	$V_O = \pm 2.3 \text{ V}$	$R_L = 600 \Omega$	25°C	80	91		80	91	dB	
			Full range	79			79			
		$R_L = 2 \text{ k}\Omega$	25°C	90	100		90	100		
			Full range	89			89			
		$R_L = 10 \text{ k}\Omega$	25°C	95	106		95	106		
			Full range	94			94			
$r_i$ Input resistance	$V_{IC} = 0$	25°C	$10^{12}$			$10^{12}$			$\Omega$	
$c_i$ Input capacitance	Common mode	$V_{IC} = 0, \text{See Figure 5}$	25°C	11			11			pF
	Differential		25°C	2.5			2.5			
$z_o$ Open-loop output impedance	$f = 1 \text{ MHz}$	25°C	80			80			$\Omega$	
CMRR Common-mode rejection ratio	$V_{IC} = V_{ICRmin}, V_O = 0, R_S = 50 \Omega$	25°C	70	89		70	89	dB		
		Full range	68			68				
$k_{SVR}$ Supply-voltage rejection ratio ( $\Delta V_{CC\pm} / \Delta V_{IO}$ )	$V_{CC\pm} = \pm 5 \text{ V to } \pm 15 \text{ V}, V_O = 0, R_S = 50 \Omega$	25°C	82	99		82	99	dB		
		Full range	80			80				

† Full range is 0°C to 70°C.

**TLE207x, TLE207xA, TLE207xY**  
**EXCALIBUR LOW-NOISE HIGH-SPEED**  
**JFET-INPUT OPERATIONAL AMPLIFIERS**  
SLOS181A – FEBRUARY 1997 – REVISED MARCH 2000

**TLE2074C electrical characteristics at specified free-air temperature,  $V_{CC\pm} = \pm 5$  V (unless otherwise noted) (continued)**

PARAMETER	TEST CONDITIONS	$T_A$ †	TLE2074C			TLE2074AC			UNIT	
			MIN	TYP	MAX	MIN	TYP	MAX		
$I_{CC}$	Supply current (four amplifiers)	$V_O = 0$ , No load	25°C	5.2	6.3	7.5	5.2	6.3	7.5	mA
			Full range	7.5			7.5			
	Crosstalk attenuation	$V_{IC} = 0$ , $R_L = 2$ k $\Omega$	25°C	120			120			dB
$I_{OS}$	Short-circuit output current	$V_O = 0$	$V_{ID} = 1$ V	-35			-35			mA
			$V_{ID} = -1$ V	45			45			

† Full range is 0°C to 70°C.

**TLE2074C operating characteristics at specified free-air temperature,  $V_{CC\pm} = \pm 5$  V**

PARAMETER	TEST CONDITIONS	$T_A$ †	TLE2074C			TLE2074AC			UNIT	
			MIN	TYP	MAX	MIN	TYP	MAX		
SR+	Positive slew rate	$V_{O(PP)} = \pm 2.3$ V, $A_{VD} = -1$ , $C_L = 100$ pF, $R_L = 2$ k $\Omega$ , See Figure 1	25°C	35			35			V/ $\mu$ s
			Full range	22			22			
SR-	Negative slew rate		25°C	38			38			V/ $\mu$ s
			Full range	22			22			
$t_s$	Settling time	$A_{VD} = -1$ , 2-V step, $R_L = 1$ k $\Omega$ , $C_L = 100$ pF	To 10 mV	0.25			0.25			$\mu$ s
			To 1 mV	0.4			0.4			
$V_n$	Equivalent input noise voltage	$R_S = 20$ $\Omega$ , See Figure 3	f = 10 Hz	28	55		28	55	nV/ $\sqrt{Hz}$	
			f = 10 kHz	11.6	17		11.6	17		
$V_{N(PP)}$	Peak-to-peak equivalent input noise voltage		f = 10 Hz to 10 kHz	6			6			$\mu$ V
			f = 0.1 Hz to 10 Hz	0.6			0.6			
$I_n$	Equivalent input noise current	$V_{IC} = 0$ , f = 10 kHz	25°C	2.8			2.8			fA/ $\sqrt{Hz}$
THD + N	Total harmonic distortion plus noise	$V_{O(PP)} = 5$ V, f = 1 kHz, $R_S = 25$ $\Omega$	25°C	0.013%			0.013%			
$B_1$	Unity-gain bandwidth	$V_I = 10$ mV, $C_L = 25$ pF, $R_L = 2$ k $\Omega$ , See Figure 2	25°C	9.4			9.4			MHz
$B_{OM}$	Maximum output-swing bandwidth	$V_{O(PP)} = 4$ V, $R_L = 2$ k $\Omega$ , $A_{VD} = -1$ , $C_L = 25$ pF	25°C	2.8			2.8			MHz
$\phi_m$	Phase margin at unity gain	$V_I = 10$ mV, $C_L = 25$ pF, $R_L = 2$ k $\Omega$ , See Figure 2	25°C	56°			56°			

† Full range is 0°C to 70°C.

**TLE207x, TLE207xA, TLE207xY**  
**EXCALIBUR LOW-NOISE HIGH-SPEED**  
**JFET-INPUT OPERATIONAL AMPLIFIERS**

SLOS181A – FEBRUARY 1997 – REVISED MARCH 2000

**TLE2074C electrical characteristics at specified free-air temperature,  $V_{CC\pm} = \pm 15$  V (unless otherwise noted)**

PARAMETER	TEST CONDITIONS	$T_A$ †	TLE2074C			TLE2074AC			UNIT	
			MIN	TYP	MAX	MIN	TYP	MAX		
$V_{IO}$ Input offset voltage	$V_{IC} = 0, V_O = 0, R_S = 50 \Omega$	25°C	-1.6	5		-0.5	3	mV		
		Full range			7.1		5.1			
$\alpha_{VIO}$ Temperature coefficient of input offset voltage		Full range	10.1	30		10.1	30	$\mu V/^\circ C$		
$I_{IO}$ Input offset current	$V_{IC} = 0, V_O = 0, \text{See Figure 4}$	25°C	15	100		15	100	pA		
		Full range			1400		1400			
$I_{IB}$ Input bias current		25°C	25	175		25	175	pA		
		Full range			5000		5000			
$V_{ICR}$ Common-mode input voltage range	$R_S = 50 \Omega$	25°C	15 to -11	15 to -11.9		15 to -11	15 to -11.9	V		
		Full range	15 to -10.9			15 to -10.9				
$V_{OM+}$ Maximum positive peak output voltage swing	$I_O = -200 \mu A$	25°C	13.8	14.1		13.8	14.1	V		
		Full range	13.7			13.7				
	$I_O = -2 \text{ mA}$	25°C	13.5	13.9		13.5	13.9			
		Full range	13.4			13.4				
	$I_O = -20 \text{ mA}$	25°C	11.5	12.3		11.5	12.3			
		Full range	11.5			11.5				
$V_{OM-}$ Maximum negative peak output voltage swing	$I_O = 200 \mu A$	25°C	-13.8	-14.2		-13.8	-14.2	V		
		Full range	-13.7			-13.7				
	$I_O = 2 \text{ mA}$	25°C	-13.7	-14		-13.7	-14			
		Full range	-13.6			-13.6				
	$I_O = 20 \text{ mA}$	25°C	-11.5	-12.4		-11.5	-12.4			
		Full range	-11.5			-11.5				
$A_{VD}$ Large-signal differential voltage amplification	$V_O = \pm 10 \text{ V}$	$R_L = 600 \Omega$	25°C	80	96		80	96	dB	
			Full range	79			79			
		$R_L = 2 \text{ k}\Omega$	25°C	90	109		90	109		
			Full range	89			89			
		$R_L = 10 \text{ k}\Omega$	25°C	95	118		95	118		
			Full range	94			94			
$r_i$ Input resistance	$V_{IC} = 0$	25°C	$10^{12}$			$10^{12}$			$\Omega$	
$c_i$ Input capacitance	Common mode	$V_{IC} = 0, \text{See Figure 5}$	25°C	7.5			7.5			pF
	Differential		25°C	2.5			2.5			
$z_o$ Open-loop output impedance	$f = 1 \text{ MHz}$	25°C	80			80			$\Omega$	
CMRR Common-mode rejection ratio	$V_{IC} = V_{ICRmin}, V_O = 0, R_S = 50 \Omega$	25°C	80	98		80	98	dB		
		Full range	79			79				
$k_{SVR}$ Supply-voltage rejection ratio ( $\Delta V_{CC\pm} / \Delta V_{IO}$ )	$V_{CC\pm} = \pm 5 \text{ V to } \pm 15 \text{ V}, V_O = 0, R_S = 50 \Omega$	25°C	82	99		82	99	dB		
		Full range	81			81				

† Full range is 0°C to 70°C.

**TLE207x, TLE207xA, TLE207xY**  
**EXCALIBUR LOW-NOISE HIGH-SPEED**  
**JFET-INPUT OPERATIONAL AMPLIFIERS**  
SLOS181A – FEBRUARY 1997 – REVISED MARCH 2000

**TLE2074C electrical characteristics at specified free-air temperature,  $V_{CC\pm} = \pm 15$  V (unless otherwise noted) (continued)**

PARAMETER	TEST CONDITIONS	$T_A$ †	TLE2074C			TLE2074AC			UNIT	
			MIN	TYP	MAX	MIN	TYP	MAX		
$I_{CC}$	Supply current (four amplifiers)	$V_O = 0$ , No load	25°C	5.2	6.5	7.5	5.2	6.5	7.5	mA
			Full range	7.5			7.5			
	Crosstalk attenuation	$V_{IC} = 0$ , $R_L = 2$ k $\Omega$	25°C	120			120			dB
$I_{OS}$	Short-circuit output current	$V_O = 0$	25°C	$V_{ID} = 1$ V	-30	-45	-30	-45	mA	
				$V_{ID} = -1$ V	30	48	30	48		

† Full range is 0°C to 70°C.

**TLE2074C operating characteristics at specified free-air temperature,  $V_{CC\pm} = \pm 15$  V**

PARAMETER	TEST CONDITIONS	$T_A$ †	TLE2074C			TLE2074AC			UNIT
			MIN	TYP	MAX	MIN	TYP	MAX	
SR+	Positive slew rate	$V_{O(PP)} = 10$ V, $A_{VD} = -1$ , $R_L = 2$ k $\Omega$ , $C_L = 100$ pF, See Figure 1	25°C	25	40	25	40	V/ $\mu$ s	
			Full range	22			22		
SR-	Negative slew rate	$V_{O(PP)} = 10$ V, $A_{VD} = -1$ , $R_L = 2$ k $\Omega$ , $C_L = 100$ pF, See Figure 1	25°C	30	45	30	45	V/ $\mu$ s	
			Full range	25			25		
$t_s$	Settling time	$A_{VD} = -1$ , 10-V step, $R_L = 1$ k $\Omega$ , $C_L = 100$ pF	25°C	To 10 mV	0.4		0.4		$\mu$ s
				To 1 mV	1.5		1.5		
$V_n$	Equivalent input noise voltage	$R_S = 20$ $\Omega$ , See Figure 3	25°C	$f = 10$ Hz	28	55	28	55	nV/ $\sqrt{Hz}$
				$f = 10$ kHz	11.6	17	11.6	17	
$V_{N(PP)}$	Peak-to-peak equivalent input noise voltage	$R_S = 20$ $\Omega$ , See Figure 3	25°C	$f = 10$ Hz to 10 kHz	6		6		$\mu$ V
				$f = 0.1$ Hz to 10 Hz	0.6		0.6		
$I_n$	Equivalent input noise current	$V_{IC} = 0$ , $f = 10$ kHz	25°C	2.8		2.8		fA/ $\sqrt{Hz}$	
THD + N	Total harmonic distortion plus noise	$V_{O(PP)} = 20$ V, $f = 1$ kHz, $R_S = 25$ $\Omega$	25°C	0.008%		0.008%			
$B_1$	Unity-gain bandwidth	$V_I = 10$ mV, $R_L = 2$ k $\Omega$ , $C_L = 25$ pF, See Figure 2	25°C	8	10	8	10	MHz	
$B_{OM}$	Maximum output-swing bandwidth	$V_{O(PP)} = 20$ V, $R_L = 2$ k $\Omega$ , $C_L = 25$ pF	25°C	478	637	478	637	kHz	
$\phi_m$	Phase margin at unity gain	$V_I = 10$ mV, $R_L = 2$ k $\Omega$ , $C_L = 25$ pF, See Figure 2	25°C	57°		57°			

† Full range is 0°C to 70°C.

# TLE207x, TLE207xA, TLE207xY EXCALIBUR LOW-NOISE HIGH-SPEED JFET-INPUT OPERATIONAL AMPLIFIERS

SLOS181A – FEBRUARY 1997 – REVISED MARCH 2000

**TLE2074I electrical characteristics at specified free-air temperature,  $V_{CC\pm} = \pm 5\text{ V}$  (unless otherwise noted)**

PARAMETER	TEST CONDITIONS	$T_A$ †	TLE2074I			TLE2074AI			UNIT	
			MIN	TYP	MAX	MIN	TYP	MAX		
$V_{IO}$ Input offset voltage	$V_{IC} = 0, V_O = 0, R_S = 50\ \Omega$	25°C	-1.6 5			-0.5 3			mV	
		Full range				7				
$\alpha_{VIO}$ Temperature coefficient of input offset voltage		Full range	10.1 30			10.1 30			$\mu\text{V}/^\circ\text{C}$	
$I_{IO}$ Input offset current	$V_{IC} = 0, V_O = 0, \text{See Figure 4}$	25°C	15 100			15 100			pA	
		Full range				5			nA	
$I_{IB}$ Input bias current		25°C	20 175			20 175			pA	
		Full range				10			nA	
$V_{ICR}$ Common-mode input voltage range	$R_S = 50\ \Omega$	25°C	5 to -1 5 to -1.9			5 to -1 5 to -1.9			V	
		Full range	5 to -0.8			5 to -0.8				
$V_{OM+}$ Maximum positive peak output voltage swing	$I_O = -200\ \mu\text{A}$	25°C	3.8 4.1			3.8 4.1			V	
		Full range	3.7			3.7				
	$I_O = -2\ \text{mA}$	25°C	3.5 3.9			3.5 3.9				
		Full range	3.4			3.4				
	$I_O = -20\ \text{mA}$	25°C	1.5 2.3			1.5 2.3				
		Full range	1.5			1.5				
$V_{OM-}$ Maximum negative peak output voltage swing	$I_O = 200\ \mu\text{A}$	25°C	-3.8 -4.2			-3.8 -4.2			V	
		Full range	-3.7			-3.7				
	$I_O = 2\ \text{mA}$	25°C	-3.5 -4.1			-3.5 -4.1				
		Full range	-3.4			-3.4				
	$I_O = 20\ \text{mA}$	25°C	-1.5 -2.4			-1.5 -2.4				
		Full range	-1.5			-1.5				
$A_{VD}$ Large-signal differential voltage amplification	$V_O = \pm 2.3\ \text{V}$	$R_L = 600\ \Omega$	25°C	80 91			80 91			dB
			Full range	79			79			
		$R_L = 2\ \text{k}\Omega$	25°C	90 100			90 100			
			Full range	89			89			
		$R_L = 10\ \text{k}\Omega$	25°C	95 106			95 106			
			Full range	94			94			
$r_i$ Input resistance	$V_{IC} = 0$	25°C	$10^{12}$			$10^{12}$			$\Omega$	
$c_i$ Input capacitance	$V_{IC} = 0, \text{See Figure 5}$	Common mode	25°C	11			11			pF
		Differential	25°C	2.5			2.5			
$z_o$ Open-loop output impedance	$f = 1\ \text{MHz}$	25°C	80			80			$\Omega$	
CMRR Common-mode rejection ratio	$V_{IC} = V_{ICRmin}, V_O = 0, R_S = 50\ \Omega$	25°C	70 89			70 89			dB	
		Full range	68			68				
$k_{SVR}$ Supply-voltage rejection ratio ( $\Delta V_{CC\pm}/\Delta V_{IO}$ )	$V_{CC\pm} = \pm 5\ \text{V to } \pm 15\ \text{V}, V_O = 0, R_S = 50\ \Omega$	25°C	82 99			82 99			dB	
		Full range	80			80				

† Full range is  $-40^\circ\text{C}$  to  $85^\circ\text{C}$ .



**TLE207x, TLE207xA, TLE207xY**  
**EXCALIBUR LOW-NOISE HIGH-SPEED**  
**JFET-INPUT OPERATIONAL AMPLIFIERS**

SLOS181A – FEBRUARY 1997 – REVISED MARCH 2000

**TLE2074I electrical characteristics at specified free-air temperature,  $V_{CC\pm} = \pm 5\text{ V}$  (unless otherwise noted) (continued)**

PARAMETER	TEST CONDITIONS	$T_A$ †	TLE2074I			TLE2074AI			UNIT
			MIN	TYP	MAX	MIN	TYP	MAX	
$I_{CC}$ Supply current (four amplifiers)	$V_O = 0$ , No load	25°C	5.2	6.3	7.5	5.2	6.3	7.5	mA
		Full range	7.5			7.5			
Crosstalk attenuation	$V_{IC} = 0$ , $R_L = 2\text{ k}\Omega$	25°C	120			120			dB
$I_{OS}$ Short-circuit output current	$V_O = 0$	25°C	$V_{ID} = 1\text{ V}$			–35			mA
			$V_{ID} = -1\text{ V}$			45			

† Full range is –40°C to 85°C.

**TLE2074I operating characteristics at specified free-air temperature,  $V_{CC\pm} = \pm 5\text{ V}$**

PARAMETER	TEST CONDITIONS	$T_A$ †	TLE2074I			TLE2074AI			UNIT	
			MIN	TYP	MAX	MIN	TYP	MAX		
SR+ Positive slew rate	$V_{O(PP)} = \pm 2.3\text{ V}$ , $A_{VD} = -1$ , $C_L = 100\text{ pF}$ , $R_L = 2\text{ k}\Omega$ , See Figure 1	25°C	35			35			V/ $\mu$ s	
		Full range	20			20				
SR– Negative slew rate		25°C	38			38			V/ $\mu$ s	
		Full range	20			20				
$t_s$ Settling time	$A_{VD} = -1$ , 2-V step, $R_L = 1\text{ k}\Omega$ , $C_L = 100\text{ pF}$	25°C	To 10 mV			0.25			$\mu$ s	
			To 1 mV			0.4				
$V_n$ Equivalent input noise voltage	$R_S = 20\ \Omega$ , See Figure 3	25°C	f = 10 Hz		28		55		nV/ $\sqrt{\text{Hz}}$	
f = 10 kHz			11.6		17					
$V_{N(PP)}$ Peak-to-peak equivalent input noise voltage		f = 10 Hz to 10 kHz	25°C	6		6		$\mu$ V		
				f = 0.1 Hz to 10 Hz		0.6				
$I_n$ Equivalent input noise current	$V_{IC} = 0$ , f = 10 kHz	25°C	2.8			2.8			fA/ $\sqrt{\text{Hz}}$	
THD + N Total harmonic distortion plus noise	$V_{O(PP)} = 5\text{ V}$ , f = 1 kHz, $R_S = 25\ \Omega$	$A_{VD} = 10$ , $R_L = 2\text{ k}\Omega$ ,	25°C	0.013%			0.013%			
$B_1$ Unity-gain bandwidth	$V_I = 10\text{ mV}$ , $C_L = 25\text{ pF}$ ,	$R_L = 2\text{ k}\Omega$ , See Figure 2	25°C	9.4			9.4			MHz
$B_{OM}$ Maximum output-swing bandwidth	$V_{O(PP)} = 4\text{ V}$ , $R_L = 2\text{ k}\Omega$ ,	$A_{VD} = -1$ , $C_L = 25\text{ pF}$	25°C	2.8			2.8			MHz
$\phi_m$ Phase margin at unity gain	$V_I = 10\text{ mV}$ , $C_L = 25\text{ pF}$ ,	$R_L = 2\text{ k}\Omega$ , See Figure 2	25°C	56°			56°			

† Full range is –40°C to 85°C.

**TLE207x, TLE207xA, TLE207xY**  
**EXCALIBUR LOW-NOISE HIGH-SPEED**  
**JFET-INPUT OPERATIONAL AMPLIFIERS**

SLOS181A – FEBRUARY 1997 – REVISED MARCH 2000

**TLE2074I electrical characteristics at specified free-air temperature,  $V_{CC\pm} = \pm 15\text{ V}$  (unless otherwise noted)**

PARAMETER	TEST CONDITIONS	$T_A$ †	TLE2074I			TLE2074AI			UNIT	
			MIN	TYP	MAX	MIN	TYP	MAX		
$V_{IO}$ Input offset voltage	$V_{IC} = 0, V_O = 0, R_S = 50\ \Omega$	25°C	-1.6	5		-0.5	3	mV		
		Full range			9		7			
$\alpha_{VIO}$ Temperature coefficient of input offset voltage		Full range	10.1	30		10.1	30	$\mu\text{V}/^\circ\text{C}$		
$I_{IO}$ Input offset current	$V_{IC} = 0, V_O = 0, \text{See Figure 4}$	25°C	15	100		15	100	pA		
		Full range			5		5	nA		
$I_{IB}$ Input bias current		25°C	25	175		25	175	pA		
		Full range			10		10	nA		
$V_{ICR}$ Common-mode input voltage range	$R_S = 50\ \Omega$	25°C	15 to -11	15 to -11.9		15 to -11	15 to -11.9	V		
		Full range	15 to -10.8			15 to -10.8				
$V_{OM+}$ Maximum positive peak output voltage swing	$I_O = -200\ \mu\text{A}$	25°C	13.8	14.1		13.8	14.1	V		
		Full range	13.7			13.7				
	$I_O = -2\ \text{mA}$	25°C	13.5	13.9		13.5	13.9			
		Full range	13.4			13.4				
	$I_O = -20\ \text{mA}$	25°C	11.5	12.3		11.5	12.3			
		Full range	11.5			11.5				
$V_{OM-}$ Maximum negative peak output voltage swing	$I_O = 200\ \mu\text{A}$	25°C	-13.8	-14.2		-13.8	-14.2	V		
		Full range	-13.7			-13.7				
	$I_O = 2\ \text{mA}$	25°C	-13.5	-14		-13.5	-14			
		Full range	-13.4			-13.4				
	$I_O = 20\ \text{mA}$	25°C	-11.5	-12.4		-11.5	-12.4			
		Full range	-11.5			-11.5				
$A_{VD}$ Large-signal differential voltage amplification	$V_O = \pm 10\ \text{V}$	$R_L = 600\ \Omega$	25°C	80	96		80	96	dB	
			Full range	79			79			
		$R_L = 2\ \text{k}\Omega$	25°C	90	109		90	109		
			Full range	89			89			
		$R_L = 10\ \text{k}\Omega$	25°C	95	118		95	118		
			Full range	94			94			
$r_i$ Input resistance	$V_{IC} = 0$	25°C	$10^{12}$			$10^{12}$			$\Omega$	
$c_i$ Input capacitance	Common mode	$V_{IC} = 0, \text{See Figure 5}$	25°C	7.5			7.5			pF
			25°C	2.5			2.5			
$z_o$ Open-loop output impedance		$f = 1\ \text{MHz}$	25°C	80			80			$\Omega$
CMRR Common-mode rejection ratio	$V_{IC} = V_{ICRmin}, V_O = 0, R_S = 50\ \Omega$	25°C	80	98		80	98	dB		
		Full range	79			79				
$k_{SVR}$ Supply-voltage rejection ratio ( $\Delta V_{CC\pm}/\Delta V_{IO}$ )	$V_{CC\pm} = \pm 5\ \text{V to } \pm 15\ \text{V}, V_O = 0, R_S = 50\ \Omega$	25°C	82	99		82	99	dB		
		Full range	80			80				

† Full range is  $-40^\circ\text{C}$  to  $85^\circ\text{C}$ .

**TLE207x, TLE207xA, TLE207xY**  
**EXCALIBUR LOW-NOISE HIGH-SPEED**  
**JFET-INPUT OPERATIONAL AMPLIFIERS**  
 SLOS181A – FEBRUARY 1997 – REVISED MARCH 2000

**TLE2074I electrical characteristics at specified free-air temperature,  $V_{CC\pm} = \pm 15$  V (unless otherwise noted) (continued)**

PARAMETER	TEST CONDITIONS	$T_A$ †	TLE2074I			TLE2074AI			UNIT
			MIN	TYP	MAX	MIN	TYP	MAX	
$I_{CC}$ Supply current (four amplifiers)	$V_O = 0$ , No load	25°C	5.2	6.5	7.5	5.2	6.5	7.5	mA
		Full range	7.5			7.5			
Crosstalk attenuation	$V_{IC} = 0$ , $R_L = 2$ k $\Omega$	25°C	120			120			dB
$I_{OS}$ Short-circuit output current	$V_O = 0$	$V_{ID} = 1$ V	-30	-45		-30	-45		mA
		$V_{ID} = -1$ V	30	48		30	48		

† Full range is  $-40^\circ\text{C}$  to  $85^\circ\text{C}$ .

**TLE2074I operating characteristics at specified free-air temperature,  $V_{CC\pm} = \pm 15$  V**

PARAMETER	TEST CONDITIONS	$T_A$ †	TLE2074I			TLE2074AI			UNIT	
			MIN	TYP	MAX	MIN	TYP	MAX		
SR+ Positive slew rate	$V_{O(PP)} = \pm 10$ V, $A_{VD} = -1$ , $C_L = 100$ pF, $R_L = 2$ k $\Omega$ , See Figure 1	25°C	25	40		25	40		V/ $\mu$ s	
		Full range	19			19				
SR- Negative slew rate		25°C	30	45		30	45		V/ $\mu$ s	
		Full range	22			22				
$t_s$ Settling time	$A_{VD} = -1$ , 10-V step, $R_L = 1$ k $\Omega$ , $C_L = 100$ pF	To 10 mV	0.4			0.4			$\mu$ s	
		To 1 mV	1.5			1.5				
$V_n$ Equivalent input noise voltage	$R_S = 20$ $\Omega$ , See Figure 3	f = 10 Hz	28	55		28	55		nV/ $\sqrt{\text{Hz}}$	
		f = 10 kHz	11.6	17		11.6	17			
$V_{N(PP)}$ Peak-to-peak equivalent input noise voltage		f = 10 Hz to 10 kHz	6			6			$\mu$ V	
		f = 0.1 Hz to 10 Hz	0.6			0.6				
$I_n$ Equivalent input noise current	$V_{IC} = 0$ , f = 10 kHz	25°C	2.8			2.8			fA/ $\sqrt{\text{Hz}}$	
THD + N Total harmonic distortion plus noise	$V_{O(PP)} = 20$ V, f = 1 kHz, $R_S = 25$ $\Omega$	$A_{VD} = 10$ , $R_L = 2$ k $\Omega$ ,	25°C	0.008%			0.008%			
$B_1$ Unity-gain bandwidth	$V_I = 10$ mV, $C_L = 25$ pF,	$R_L = 2$ k $\Omega$ , See Figure 2	25°C	8	10		8	10	MHz	
$B_{OM}$ Maximum output-swing bandwidth	$V_{O(PP)} = 20$ V, $R_L = 2$ k $\Omega$ ,	$A_{VD} = -1$ , $C_L = 25$ pF	25°C	478	637		478	637	kHz	
$\phi_m$ Phase margin at unity gain	$V_I = 10$ mV, $C_L = 25$ pF,	$R_L = 2$ k $\Omega$ , See Figure 2	25°C	57°			57°			

† Full range is  $-40^\circ\text{C}$  to  $85^\circ\text{C}$ .

# TLE207x, TLE207xA, TLE207xY EXCALIBUR LOW-NOISE HIGH-SPEED JFET-INPUT OPERATIONAL AMPLIFIERS

SLOS181A – FEBRUARY 1997 – REVISED MARCH 2000

**TLE2074M electrical characteristics at specified free-air temperature,  $V_{CC\pm} = \pm 5$  V (unless otherwise noted)**

PARAMETER	TEST CONDITIONS	$T_A$ †	TLE2074M			TLE2074AM			UNIT	
			MIN	TYP	MAX	MIN	TYP	MAX		
$V_{IO}$ Input offset voltage	$V_{IC} = 0, V_O = 0, R_S = 50\Omega$	25°C	-1.6 5			-0.5 3			mV	
		Full range	10.5			8.5				
$\alpha_{VIO}$ Temperature coefficient of input offset voltage		Full range	10.1 30*			10.1 30*			$\mu V/^\circ C$	
$I_{IO}$ Input offset current	$V_{IC} = 0, V_O = 0, \text{See Figure 4}$	25°C	15 100			15 100			pA	
		Full range	20			20			nA	
$I_{IB}$ Input bias current		25°C	20 175			20 175			pA	
		Full range	60			60			nA	
$V_{ICR}$ Common-mode input voltage range	$R_S = 50\Omega$	25°C	5 to -1		5 to -1.9		5 to -1.9		V	
		Full range	5 to -0.8		5 to -0.8		5 to -0.8			
$V_{OM+}$ Maximum positive peak output voltage swing	$I_O = -200\mu A$	25°C	3.8 4.1		3.8 4.1				V	
		Full range	3.6		3.6					
	$I_O = -2\text{ mA}$	25°C	3.5 3.9		3.5 3.9					
		Full range	3.3		3.3					
	$I_O = -20\text{ mA}$	25°C	1.5 2.3		1.5 2.3					
		Full range	1.4		1.4					
$V_{OM-}$ Maximum negative peak output voltage swing	$I_O = 200\mu A$	25°C	-3.8 -4.2		-3.8 -4.2				V	
		Full range	-3.6		-3.6					
	$I_O = 2\text{ mA}$	25°C	-3.5 -4.1		-3.5 -4.1					
		Full range	-3.3		-3.3					
	$I_O = 20\text{ mA}$	25°C	-1.5 -2.4		-1.5 -2.4					
		Full range	-1.4		-1.4					
$A_{VD}$ Large-signal differential voltage amplification	$V_O = \pm 2.3\text{ V}$	$R_L = 600\Omega$	25°C	80 91		80 91				dB
			Full range	78		78				
		$R_L = 2\text{ k}\Omega$	25°C	90 100		90 100				
			Full range	88		88				
		$R_L = 10\text{ k}\Omega$	25°C	95 106		95 106				
			Full range	93		93				
$r_i$ Input resistance	$V_{IC} = 0$	25°C	10 <sup>12</sup>			10 <sup>12</sup>			$\Omega$	
$c_i$ Input capacitance	Common mode	$V_{IC} = 0, \text{See Figure 5}$	25°C	11			11			pF
	Differential		25°C	2.5			2.5			
$z_o$ Open-loop output impedance	$f = 1\text{ MHz}$	25°C	80			80			$\Omega$	
CMRR Common-mode rejection ratio	$V_{IC} = V_{ICRmin}, V_O = 0, R_S = 50\Omega$	25°C	70 89			70 89			dB	
		Full range	68			68				
$k_{SVR}$ Supply-voltage rejection ratio ( $\Delta V_{CC\pm} / \Delta V_{IO}$ )	$V_{CC\pm} = \pm 5\text{ V to } \pm 15\text{ V}, V_O = 0, R_S = 50\Omega$	25°C	82 99			82 99			dB	
		Full range	80			80				

\*On products compliant to MIL-PRF-38535, Class B, this parameter is not production tested.

† Full range is -55°C to 125°C.

**TLE207x, TLE207xA, TLE207xY**  
**EXCALIBUR LOW-NOISE HIGH-SPEED**  
**JFET-INPUT OPERATIONAL AMPLIFIERS**  
SLOS181A – FEBRUARY 1997 – REVISED MARCH 2000

**TLE2074M electrical characteristics at specified free-air temperature,  $V_{CC\pm} = \pm 5\text{ V}$  (unless otherwise noted) (continued)**

PARAMETER	TEST CONDITIONS	$T_A$ †	TLE2074M			TLE2074AM			UNIT
			MIN	TYP	MAX	MIN	TYP	MAX	
$I_{CC}$ Supply current (four amplifiers)	$V_O = 0$ , No load	25°C	5.2	6.3	7.5	5.2	6.3	7.5	mA
		Full range	7.5			7.5			
Crosstalk attenuation	$V_{IC} = 0$ , $R_L = 2\text{ k}\Omega$	25°C	120			120			dB
$I_{OS}$ Short-circuit output current	$V_O = 0$	25°C	$V_{ID} = 1\text{ V}$			-35			mA
			$V_{ID} = -1\text{ V}$			45			

† Full range is  $-55^\circ\text{C}$  to  $125^\circ\text{C}$ .

**TLE2074M operating characteristics at specified free-air temperature,  $V_{CC\pm} = \pm 5\text{ V}$**

PARAMETER	TEST CONDITIONS	$T_A$ †	TLE2074M			TLE2074AM			UNIT	
			MIN	TYP	MAX	MIN	TYP	MAX		
SR+ Positive slew rate	$V_{O(PP)} = \pm 2.3\text{ V}$ , $A_{VD} = -1$ , $C_L = 100\text{ pF}$ , $R_L = 2\text{ k}\Omega$ , See Figure 1	25°C	35			35			V/ $\mu\text{s}$	
		Full range	18*			18*				
SR- Negative slew rate	$V_{O(PP)} = \pm 2.3\text{ V}$ , $A_{VD} = -1$ , $C_L = 100\text{ pF}$ , $R_L = 2\text{ k}\Omega$ , See Figure 1	25°C	38			38			V/ $\mu\text{s}$	
		Full range	18*			18*				
$t_s$ Settling time	$A_{VD} = -1$ , 2-V step, $R_L = 1\text{ k}\Omega$ , $C_L = 100\text{ pF}$	25°C	To 10 mV			0.25			$\mu\text{s}$	
			To 1 mV			0.4				
$V_n$ Equivalent input noise voltage	$R_S = 20\ \Omega$ , See Figure 3	25°C	f = 10 Hz	28	55*	28	55*	nV/ $\sqrt{\text{Hz}}$		
			f = 10 kHz	11.6	17*	11.6	17*			
$V_{N(PP)}$ Peak-to-peak equivalent input noise voltage	$R_S = 20\ \Omega$ , See Figure 3	25°C	f = 10 Hz to 10 kHz			6			$\mu\text{V}$	
			f = 0.1 Hz to 10 Hz			0.6				
$I_n$ Equivalent input noise current	$V_{IC} = 0$ , f = 10 kHz	25°C	2.8			2.8			fA/ $\sqrt{\text{Hz}}$	
THD + N Total harmonic distortion plus noise	$V_{O(PP)} = 5\text{ V}$ , f = 1 kHz, $R_S = 25\ \Omega$	$A_{VD} = 10$ , $R_L = 2\text{ k}\Omega$	25°C	0.013%			0.013%			
$B_1$ Unity-gain bandwidth	$V_I = 10\text{ mV}$ , $C_L = 25\text{ pF}$	$R_L = 2\text{ k}\Omega$ , See Figure 2	25°C	9.4			9.4			MHz
$B_{OM}$ Maximum output-swing bandwidth	$V_{O(PP)} = 4\text{ V}$ , $R_L = 2\text{ k}\Omega$	$A_{VD} = -1$ , $C_L = 25\text{ pF}$	25°C	2.8			2.8			MHz
$f_m$ Phase margin at unity gain	$V_I = 10\text{ mV}$ , $C_L = 25\text{ pF}$	$R_L = 2\text{ k}\Omega$ , See Figure 2	25°C	56°			56°			

\*On products compliant to MIL-PRF-38535, Class B, this parameter is not production tested.

† Full range is  $-55^\circ\text{C}$  to  $125^\circ\text{C}$ .

**TLE207x, TLE207xA, TLE207xY**  
**EXCALIBUR LOW-NOISE HIGH-SPEED**  
**JFET-INPUT OPERATIONAL AMPLIFIERS**

SLOS181A – FEBRUARY 1997 – REVISED MARCH 2000

**TLE2074M electrical characteristics at specified free-air temperature,  $V_{CC\pm} = \pm 15$  V (unless otherwise noted)**

PARAMETER	TEST CONDITIONS	$T_A$ †	TLE2074M			TLE2074AM			UNIT	
			MIN	TYP	MAX	MIN	TYP	MAX		
$V_{IO}$ Input offset voltage	$V_{IC} = 0, V_O = 0, R_S = 50 \Omega$	25°C	-1.6 5			-0.5 3			mV	
		Full range	10.5			8.5				
$\alpha_{VIO}$ Temperature coefficient of input offset voltage		Full range	10.1 30*			10.1 30*			$\mu V/^\circ C$	
$I_{IO}$ Input offset current	$V_{IC} = 0, V_O = 0, \text{See Figure 4}$	25°C	15 100			15 100			pA	
		Full range	20			20			nA	
$I_{IB}$ Input bias current		25°C	25 175			25 175			pA	
		Full range	60			60			nA	
$V_{ICR}$ Common-mode input voltage range	$R_S = 50 \Omega$	25°C	15 to -11	15 to -11.9		15 to -11	15 to -11.9		V	
		Full range	15 to -10.8			15 to -10.8				
$V_{OM+}$ Maximum positive peak output voltage swing	$I_O = -200 \mu A$	25°C	13.8	14.1		13.8	14.1		V	
		Full range	13.6			13.6				
	$I_O = -2 \text{ mA}$	25°C	13.5	13.9		13.5	13.9			
		Full range	13.3			13.3				
	$I_O = -20 \text{ mA}$	25°C	11.5	12.3		11.5	12.3			
		Full range	11.4			11.4				
$V_{OM-}$ Maximum negative peak output voltage swing	$I_O = 200 \mu A$	25°C	-13.8	-14.2		-13.8	-14.2		V	
		Full range	-13.6			-13.6				
	$I_O = 2 \text{ mA}$	25°C	-13.5	-14		-13.5	-14			
		Full range	-13.3			-13.3				
	$I_O = 20 \text{ mA}$	25°C	-11.5	-12.4		-11.5	-12.4			
		Full range	-11.4			-11.4				
$A_{VD}$ Large-signal differential voltage amplification	$V_O = \pm 10 \text{ V}$	$R_L = 600 \Omega$	25°C	80	96		80	96	dB	
			Full range	78			78			
		$R_L = 2 \text{ k}\Omega$	25°C	90	109		90	109		
			Full range	88			88			
		$R_L = 10 \text{ k}\Omega$	25°C	95	118		95	118		
			Full range	93			93			
$r_i$ Input resistance	$V_{IC} = 0$	25°C	$10^{12}$			$10^{12}$			$\Omega$	
$C_i$ Input capacitance	Common mode	$V_{IC} = 0, \text{See Figure 5}$	25°C	7.5			7.5			pF
	Differential		25°C	2.5			2.5			
$z_o$ Open-loop output impedance	$f = 1 \text{ MHz}$	25°C	80			80			$\Omega$	
CMRR Common-mode rejection ratio	$V_{IC} = V_{ICRmin}, V_O = 0, R_S = 50 \Omega$	25°C	80	98		80	98		dB	
		Full range	78			78				
$k_{SVR}$ Supply-voltage rejection ratio ( $\Delta V_{CC\pm} / \Delta V_{IO}$ )	$V_{CC\pm} = \pm 5 \text{ V to } \pm 15 \text{ V}, V_O = 0, R_S = 50 \Omega$	25°C	82	99		82	99		dB	
		Full range	80			80				

\*On products compliant to MIL-PRF-38535, Class B, this parameter is not production tested.

† Full range is -55°C to 125°C.

**TLE207x, TLE207xA, TLE207xY**  
**EXCALIBUR LOW-NOISE HIGH-SPEED**  
**JFET-INPUT OPERATIONAL AMPLIFIERS**  
 SLOS181A – FEBRUARY 1997 – REVISED MARCH 2000

**TLE2074M electrical characteristics at specified free-air temperature,  $V_{CC\pm} = \pm 15$  V (unless otherwise noted) (continued)**

PARAMETER	TEST CONDITIONS	$T_A$ †	TLE2074M			TLE2074AM			UNIT
			MIN	TYP	MAX	MIN	TYP	MAX	
$I_{CC}$	Supply current (four amplifiers) $V_O = 0$ , No load	25°C	5.2	6.5	7.5	5.2	6.5	7.5	mA
		Full range	7.5			7.5			
	Crosstalk attenuation	$V_{IC} = 0$ , $R_L = 2$ k $\Omega$	120			120			dB
$I_{OS}$	Short-circuit output current $V_O = 0$	25°C	$V_{ID} = 1$ V	-30	-45	-30	-45	mA	
			$V_{ID} = -1$ V	30	48	30	48		

† Full range is  $-55^\circ\text{C}$  to  $125^\circ\text{C}$ .

**TLE2074M operating characteristics at specified free-air temperature,  $V_{CC\pm} = \pm 15$  V**

PARAMETER	TEST CONDITIONS	$T_A$ †	TLE2074M			TLE2074AM			UNIT
			MIN	TYP	MAX	MIN	TYP	MAX	
SR+	Positive slew rate $V_{O(PP)} = 10$ V, $A_{VD} = -1$ , $R_L = 2$ k $\Omega$ , $C_L = 100$ pF, See Figure 1	25°C	25	40		25	40	V/ $\mu$ s	
		Full range	17			17			
SR-	Negative slew rate	25°C	30	45		30	45	V/ $\mu$ s	
		Full range	20			20			
$t_s$	Settling time $A_{VD} = -1$ , 10-V step, $R_L = 1$ k $\Omega$ , $C_L = 100$ pF	25°C	To 10 mV	0.4		0.4		$\mu$ s	
			To 1 mV	1.5		1.5			
$V_n$	Equivalent input noise voltage $R_S = 20$ $\Omega$ , See Figure 3	25°C	f = 10 Hz	28	55*	28	55*	nV/ $\sqrt{\text{Hz}}$	
			f = 10 kHz	11.6	17*	11.6	17*		
$V_{N(PP)}$	Peak-to-peak equivalent input noise voltage	25°C	f = 10 Hz to 10 kHz	6		6		$\mu$ V	
			f = 0.1 Hz to 10 Hz	0.6		0.6			
$I_n$	Equivalent input noise current $V_{IC} = 0$ , f = 10 kHz	25°C	2.8		2.8		fA/ $\sqrt{\text{Hz}}$		
THD + N	Total harmonic distortion plus noise $V_{O(PP)} = 20$ V, $A_{VD} = 10$ , f = 1 kHz, $R_L = 2$ k $\Omega$ , $R_S = 25$ $\Omega$	25°C	0.008%		0.008%				
$B_1$	Unity-gain bandwidth $V_I = 10$ mV, $R_L = 2$ k $\Omega$ , $C_L = 25$ pF, See Figure 2	25°C	8*	10	8*	10	MHz		
$B_{OM}$	Maximum output-swing bandwidth $V_{O(PP)} = 20$ V, $A_{VD} = -1$ , $R_L = 2$ k $\Omega$ , $C_L = 25$ pF	25°C	478*	637	478*	637	kHz		
$\phi_m$	Phase margin at unity gain $V_I = 10$ mV, $R_L = 2$ k $\Omega$ , $C_L = 25$ pF, See Figure 2	25°C	57°		57°				

\*On products compliant to MIL-PRF-38535, Class B, this parameter is not production tested.

† Full range is  $-55^\circ\text{C}$  to  $125^\circ\text{C}$ .

# TLE207x, TLE207xA, TLE207xY EXCALIBUR LOW-NOISE HIGH-SPEED JFET-INPUT OPERATIONAL AMPLIFIERS

SLOS181A – FEBRUARY 1997 – REVISED MARCH 2000

## TLE2074Y electrical characteristics at $V_{CC\pm} = \pm 15\text{ V}$ , $T_A = 25^\circ\text{C}$ (unless otherwise noted)

PARAMETER		TEST CONDITIONS		TLE2074Y			UNIT
				MIN	TYP	MAX	
$V_{IO}$	Input offset voltage	$V_{IC} = 0$ , $R_S = 50\ \Omega$	$V_O = 0$ ,			5	mV
$I_{IO}$	Input offset current	$V_{IC} = 0$ ,	$V_O = 0$ ,		15	100	pA
$I_{IB}$	Input bias current	See Figure 4			25	175	pA
$V_{ICR}$	Common-mode input voltage range	$R_S = 50\ \Omega$		15 to -11	15 to 11.9		V
$V_{OM+}$	Maximum positive peak output voltage swing	$I_O = -200\ \mu\text{A}$		13.8	14.1		V
		$I_O = -2\ \text{mA}$		13.5	13.9		
		$I_O = -20\ \text{mA}$		11.5	12.3		
$V_{OM-}$	Maximum negative peak output voltage swing	$I_O = 200\ \mu\text{A}$		-13.8	-14.2		V
		$I_O = 2\ \text{mA}$		-13.5	-14		
		$I_O = 20\ \text{mA}$		-11.5	-12.4		
$A_{VD}$	Large-signal differential voltage amplification	$V_O = \pm 10\ \text{V}$		$R_L = 600\ \Omega$	80	96	dB
				$R_L = 2\ \text{k}\Omega$	90	109	
				$R_L = 10\ \text{k}\Omega$	95	118	
$r_i$	Input resistance	$V_{IC} = 0$		10 <sup>12</sup>			$\Omega$
$c_i$	Input capacitance	Common mode	$V_O = 0$ ,	See Figure 5		7.5	pF
		Differential				2.5	
$z_o$	Open-loop output impedance	$f = 1\ \text{MHz}$		80			$\Omega$
CMRR	Common-mode rejection ratio	$V_{IC} = V_{ICRmin}$ , $R_S = 50\ \Omega$	$V_O = 0$ ,	80	98		dB
$k_{SVR}$	Supply-voltage rejection ratio ( $\Delta V_{CC\pm}/\Delta V_{IO}$ )	$V_{CC\pm} = \pm 5\ \text{V to } \pm 15\ \text{V}$ , $V_O = 0$ , $R_S = 50\ \Omega$		82	99		dB
$I_{CC}$	Supply current (four amplifiers)	$V_O = 0$ , No load		5.2	6.5	7.5	mA
$I_{OS}$	Short-circuit output current	$V_O = 0$		$V_{ID} = 1\ \text{V}$	-30	-45	mA
				$V_{ID} = -1\ \text{V}$	30	48	

## PARAMETER MEASUREMENT INFORMATION

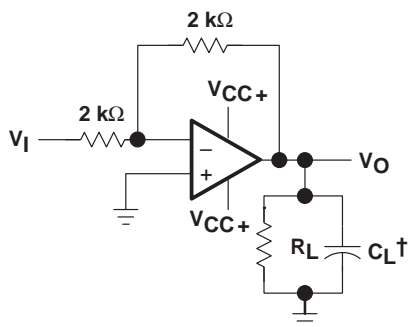

† Includes fixture capacitance

Figure 1. Slew-Rate Test Circuit

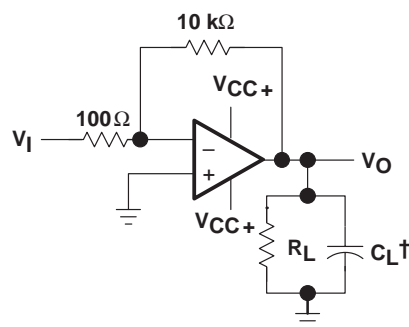

† Includes fixture capacitance

Figure 2. Unity-Gain Bandwidth and Phase-Margin Test Circuit



PARAMETER MEASUREMENT INFORMATION

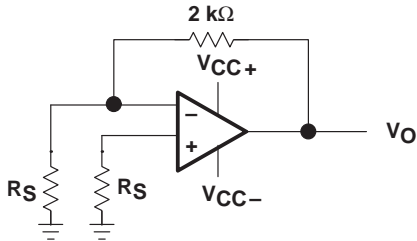

Figure 3. Noise-Voltage Test Circuit

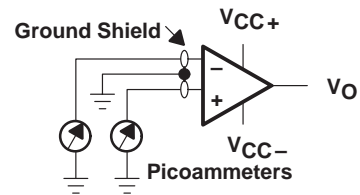

Figure 4. Input-Bias and Offset-Current Test Circuit

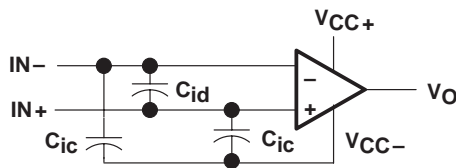

Figure 5. Internal Input Capacitance

typical values

Typical values presented in this data sheet represent the median (50% point) of device parametric performance.

input bias and offset current

At the picoampere bias current level typical of the TLE207x and TLE207xA, accurate measurement of the bias current becomes difficult. Not only does this measurement require a picoammeter but test socket leakages can easily exceed the actual device bias currents. To accurately measure these small currents, Texas Instruments uses a two-step process. The socket leakage is measured using picoammeters with bias voltages applied but with no device in the socket. The device is then inserted in the socket and a second test is performed that measures both the socket leakage and the device input bias current. The two measurements are then subtracted algebraically to determine the bias current of the device.

**TLE207x, TLE207xA, TLE207xY**  
**EXCALIBUR LOW-NOISE HIGH-SPEED**  
**JFET-INPUT OPERATIONAL AMPLIFIERS**

SLOS181A – FEBRUARY 1997 – REVISED MARCH 2000

**TYPICAL CHARACTERISTICS**

**Table of Graphs**

			<b>FIGURE</b>
$V_{IO}$	Input offset voltage	Distribution	6, 7, 8
$\alpha V_{IO}$	Temperature coefficient of input offset voltage	Distribution	9, 10, 11
$I_{IO}$	Input offset current	vs Free-air temperature	12, 13
$I_{IB}$	Input bias current	vs Free-air temperature vs Total supply voltage	12, 13 14
$V_{ICR}$	Common-mode input voltage range	vs Free-air temperature	15
$V_O$	Output voltage	vs Differential input voltage	16, 17
$V_{OM+}$	Maximum positive peak output voltage	vs Output current	18
$V_{OM-}$	Maximum negative peak output voltage	vs Output current	19
$V_{OM}$	Maximum peak output voltage	vs Free-air temperature vs Supply voltage	20, 21 22
$V_{O(PP)}$	Maximum peak-to-peak output voltage	vs Frequency	23
$V_O$	Output voltage	vs Settling time	24
$A_{VD}$	Large-signal differential voltage amplification	vs Load resistance vs Free-air temperature	25 26, 27
$A_{VD}$	Small-signal differential voltage amplification	vs Frequency	28, 29
CMRR	Common-mode rejection ratio	vs Frequency vs Free-air temperature	30 31
$k_{SVR}$	Supply-voltage rejection ratio	vs Frequency vs Free-air temperature	32 33
$I_{CC}$	Supply current	vs Supply voltage vs Free-air temperature vs Differential input voltage	34, 35, 36 37, 38, 39 40 – 45
$I_{OS}$	Short-circuit output current	vs Supply voltage vs Elapsed time vs Free-air temperature	46 47 48
SR	Slew rate	vs Free-air temperature vs Load resistance vs Differential input voltage	49, 50 51 52
$V_n$	Equivalent Input noise voltage (spectral density)	vs Frequency	53
$V_n$	Input referred noise voltage	vs Noise bandwidth Over a 10-second time interval	54 55
	Third-octave spectral noise density	vs Frequency bands	56
THD + N	Total harmonic distortion plus noise	vs Frequency	57, 58
$B_1$	Unity-gain bandwidth	vs Load capacitance	59
	Gain-bandwidth product	vs Free-air temperature vs Supply voltage	60 61
	Gain margin	vs Load capacitance	62
$\phi_m$	Phase margin	vs Free-air temperature vs Supply voltage vs Load capacitance	63 64 65
	Phase shift	vs Frequency	28, 29
	Noninverting large-signal pulse response	vs Time	66
	Small-signal pulse response	vs Time	67
$z_o$	Closed-loop output impedance	vs Frequency	68
	Crosstalk attenuation	vs Frequency	69

TYPICAL CHARACTERISTICS

DISTRIBUTION OF TLE2071  
 INPUT OFFSET VOLTAGE

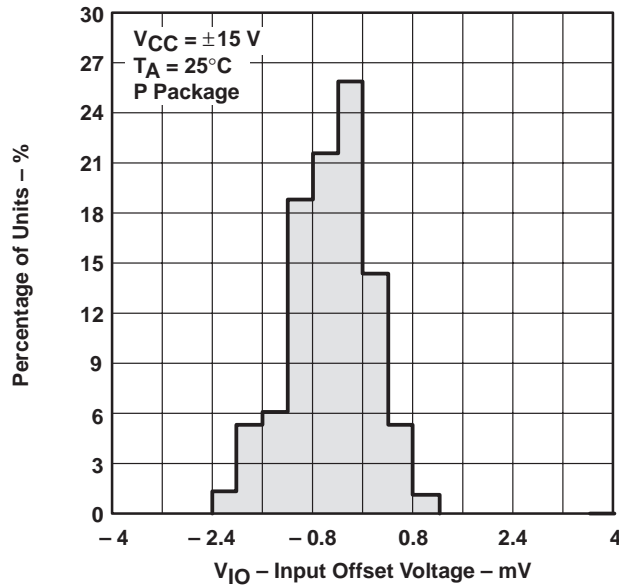

Figure 6

DISTRIBUTION OF TLE2072  
 INPUT OFFSET VOLTAGE

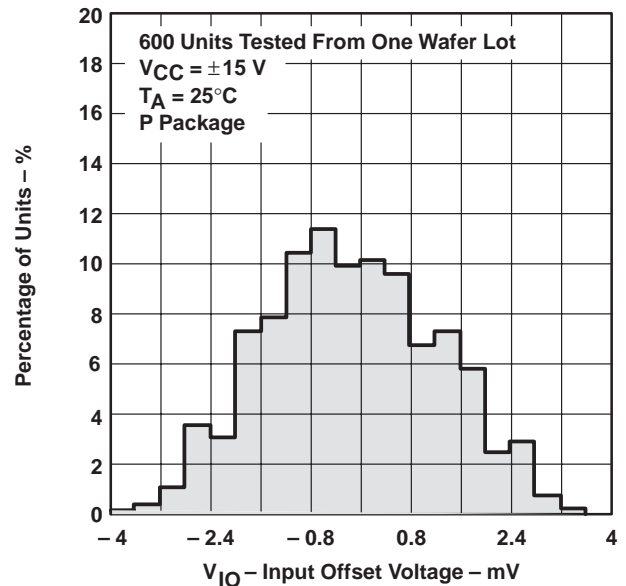

Figure 7

DISTRIBUTION OF TLE2074  
 INPUT OFFSET VOLTAGE

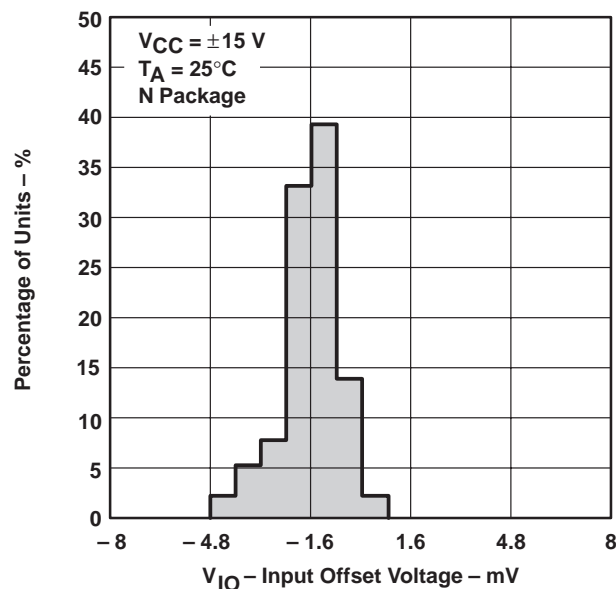

Figure 8

DISTRIBUTION OF TLE2071 INPUT OFFSET  
 VOLTAGE TEMPERATURE COEFFICIENT

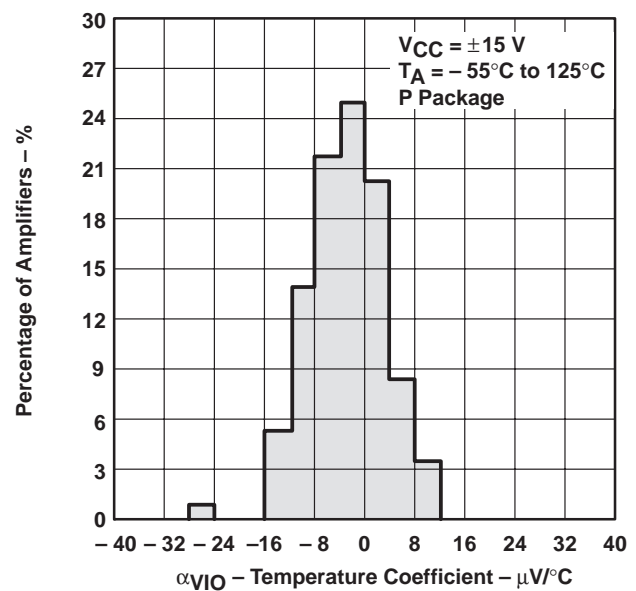
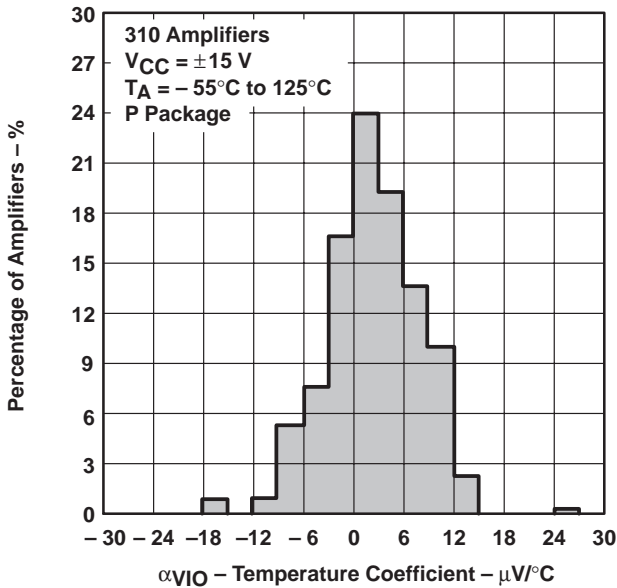

Figure 9

**TLE207x, TLE207xA, TLE207xY**  
**EXCALIBUR LOW-NOISE HIGH-SPEED**  
**JFET-INPUT OPERATIONAL AMPLIFIERS**  
 SLOS181A – FEBRUARY 1997 – REVISED MARCH 2000

**TYPICAL CHARACTERISTICS**

**DISTRIBUTION OF TLE2072 INPUT OFFSET VOLTAGE TEMPERATURE COEFFICIENT**



**Figure 10**

**DISTRIBUTION OF TLE2074 INPUT OFFSET VOLTAGE TEMPERATURE COEFFICIENT**

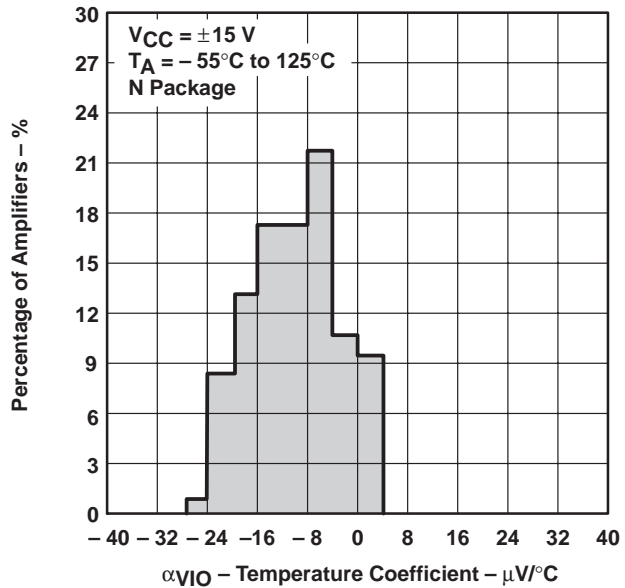

**Figure 11**

**INPUT BIAS CURRENT AND INPUT OFFSET CURRENT† VS FREE-AIR TEMPERATURE**

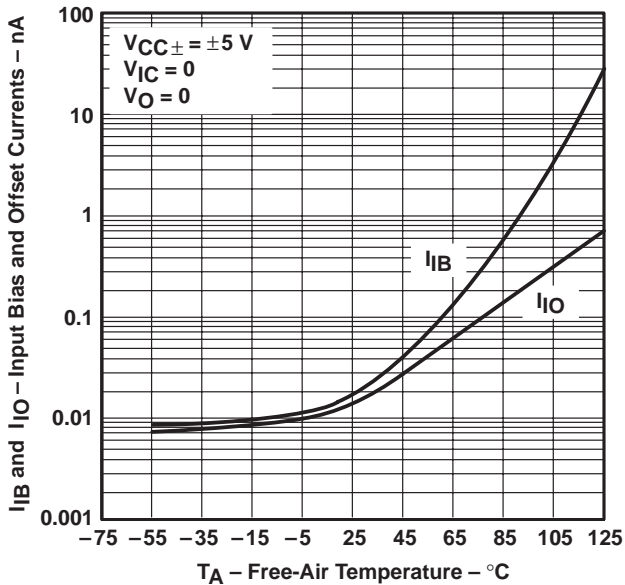

**Figure 12**

**INPUT BIAS CURRENT AND INPUT OFFSET CURRENT† VS FREE-AIR TEMPERATURE**

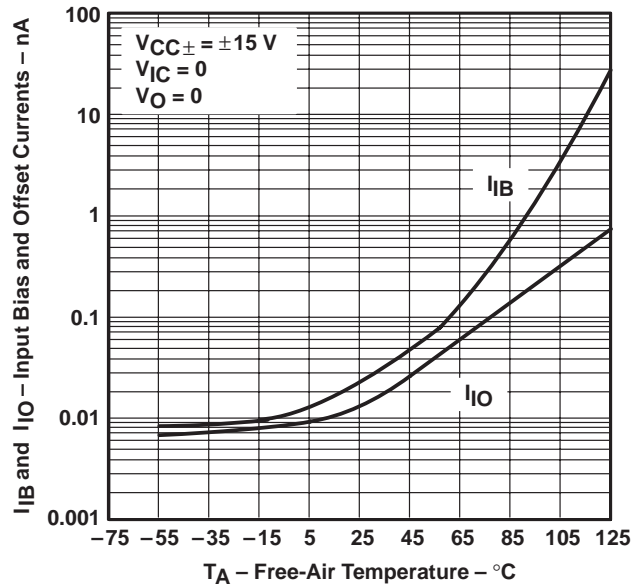

**Figure 13**

† Data at high and low temperatures are applicable only within the rated operating free-air temperature ranges of the various devices.

TYPICAL CHARACTERISTICS

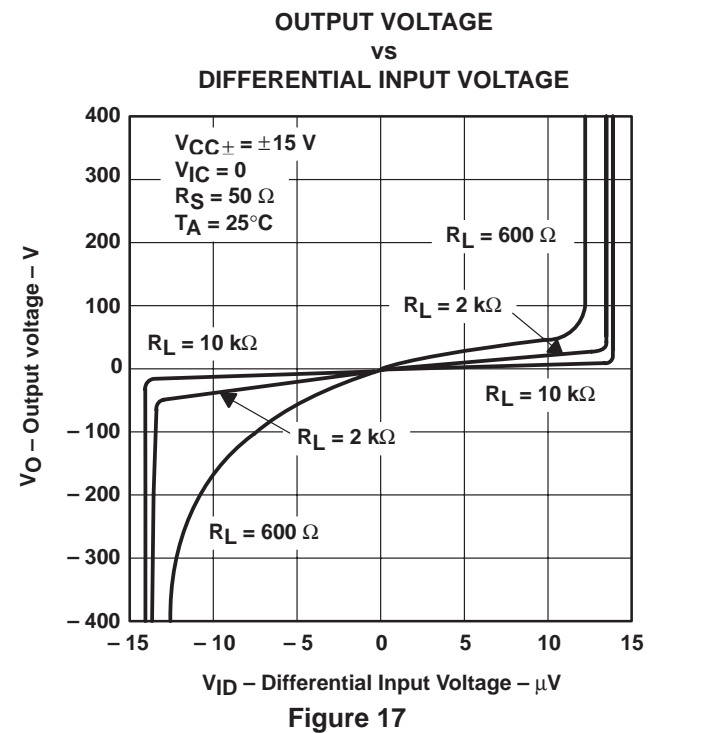
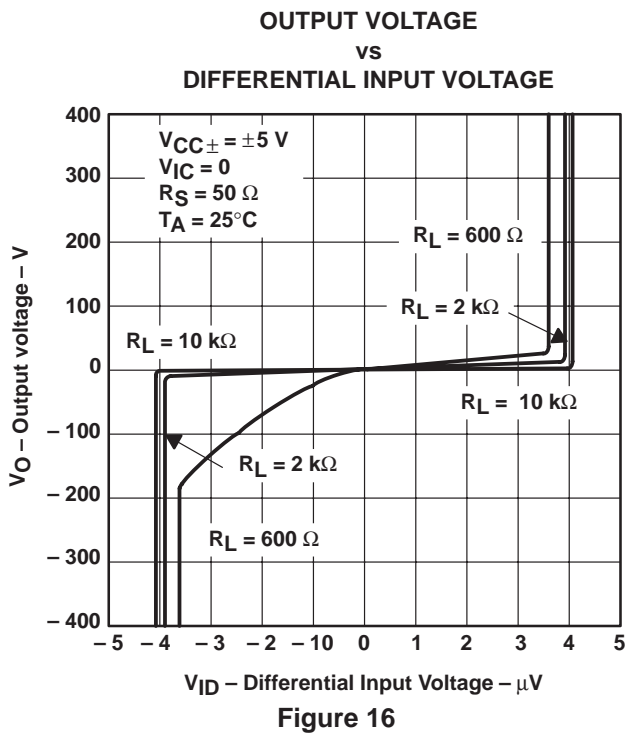
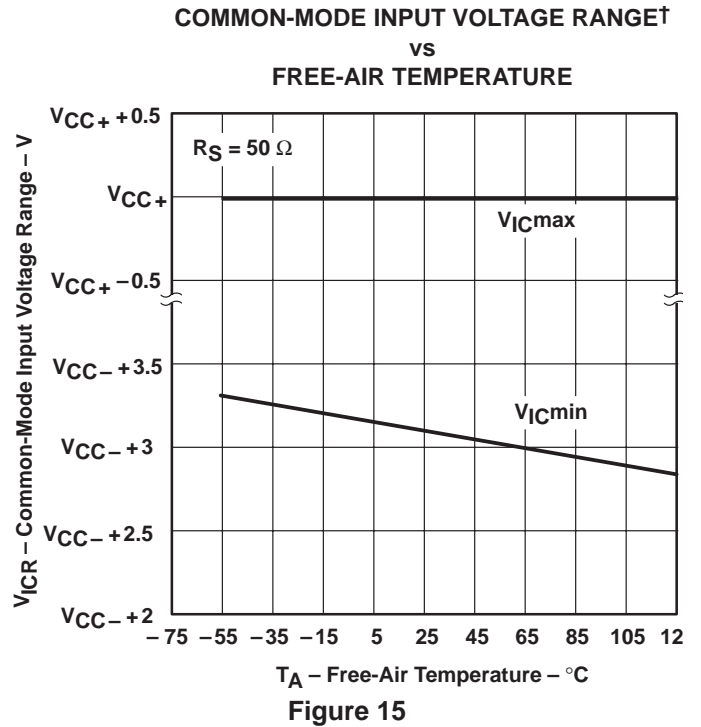
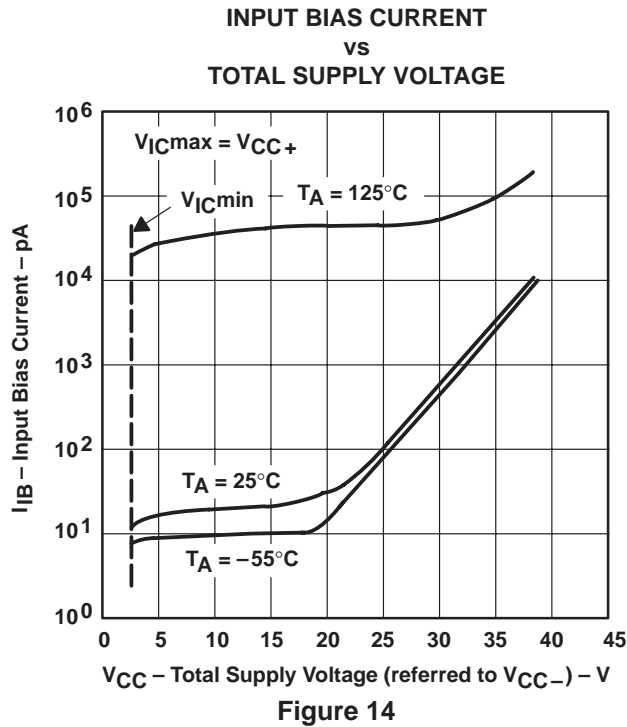

† Data at high and low temperatures are applicable only within the rated operating free-air temperature ranges of the various devices.

TYPICAL CHARACTERISTICS

MAXIMUM POSITIVE PEAK OUTPUT VOLTAGE†  
 vs  
 OUTPUT CURRENT

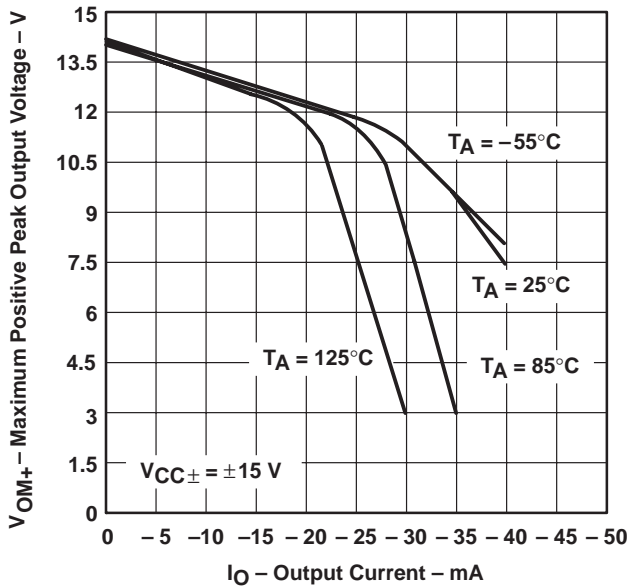

Figure 18

MAXIMUM NEGATIVE PEAK OUTPUT VOLTAGE†  
 vs  
 OUTPUT CURRENT

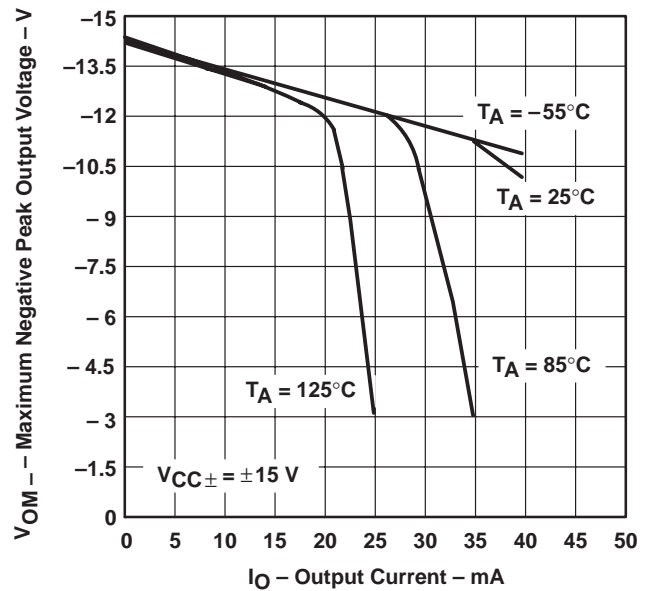

Figure 19

MAXIMUM PEAK OUTPUT VOLTAGE†  
 vs  
 FREE-AIR TEMPERATURE

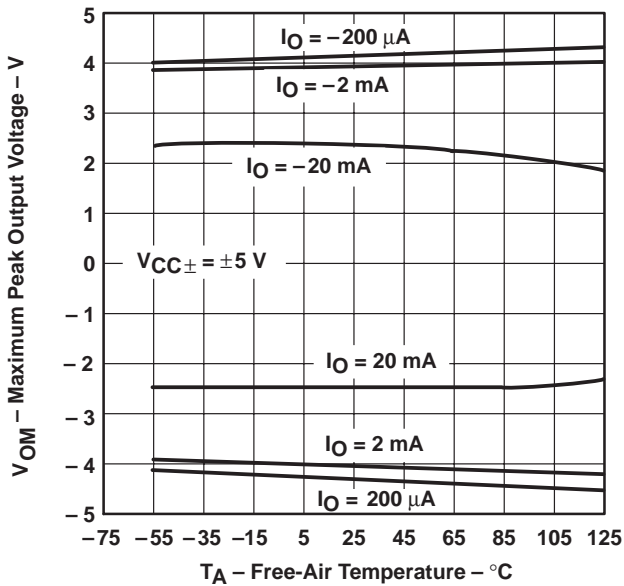

Figure 20

MAXIMUM PEAK OUTPUT VOLTAGE†  
 vs  
 FREE-AIR TEMPERATURE

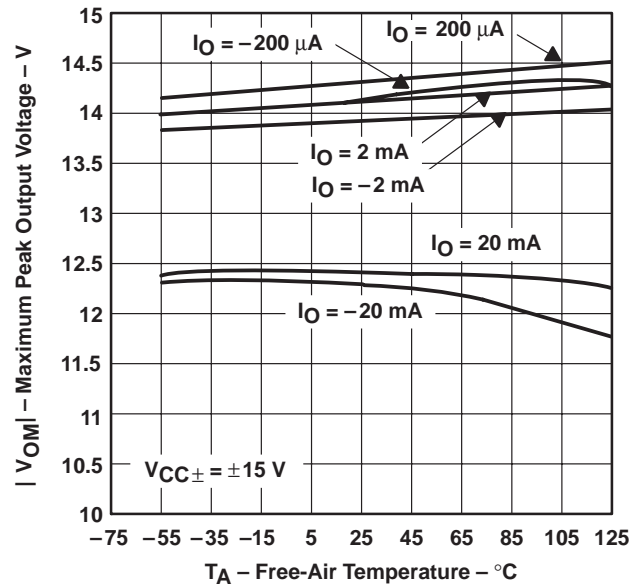
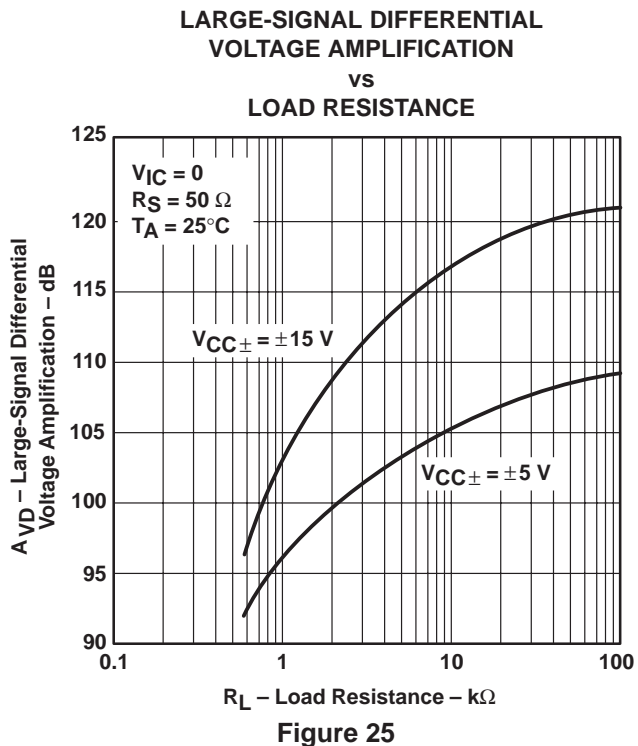
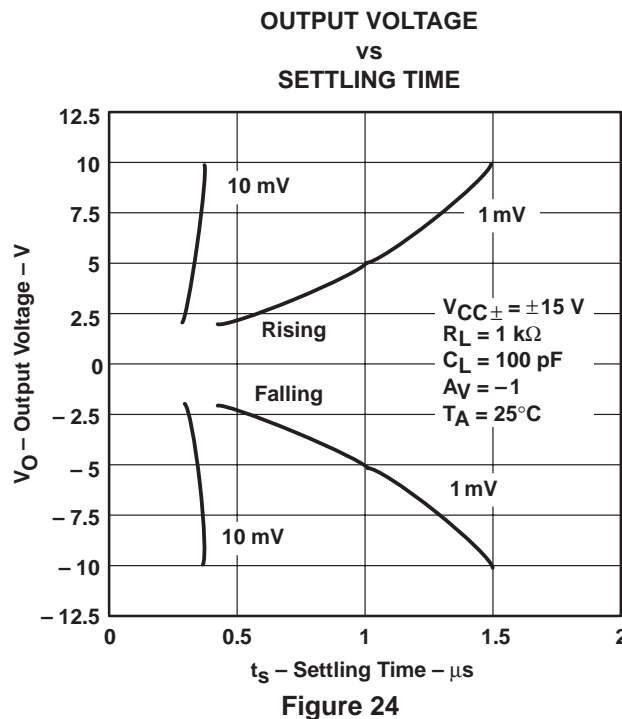
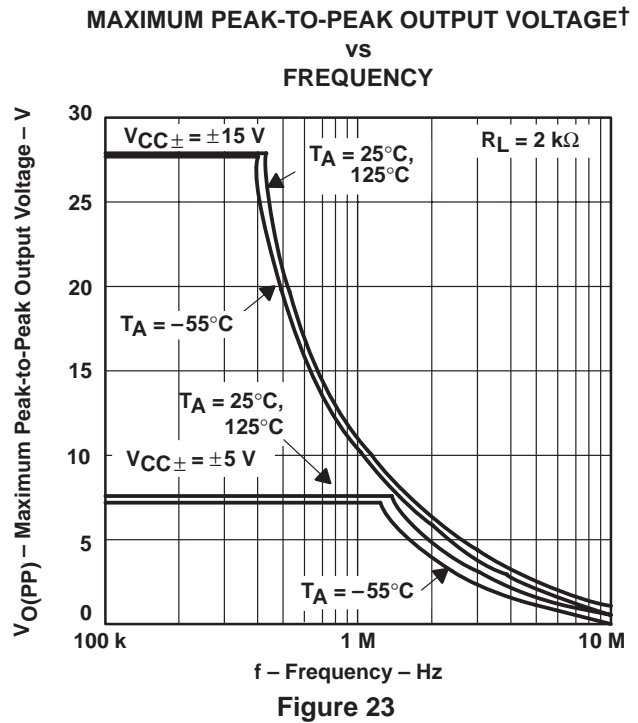
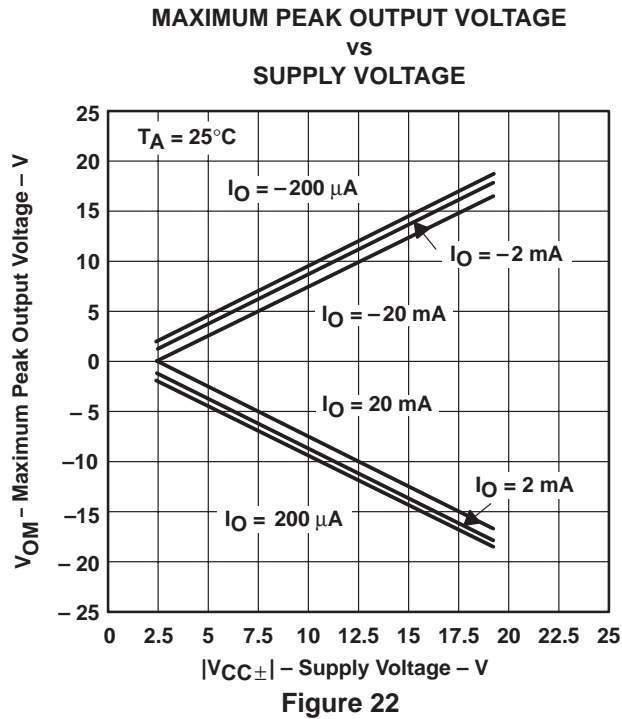

Figure 21

† Data at high and low temperatures are applicable only within the rated operating free-air temperature ranges of the various devices.

**TYPICAL CHARACTERISTICS**



† Data at high and low temperatures are applicable only within the rated operating free-air temperature ranges of the various devices.

TLE207x, TLE207xA, TLE207xY  
 EXCALIBUR LOW-NOISE HIGH-SPEED  
 JFET-INPUT OPERATIONAL AMPLIFIERS

SLOS181A – FEBRUARY 1997 – REVISED MARCH 2000

TYPICAL CHARACTERISTICS

LARGE-SIGNAL DIFFERENTIAL  
 VOLTAGE AMPLIFICATION†  
 vs  
 FREE-AIR TEMPERATURE

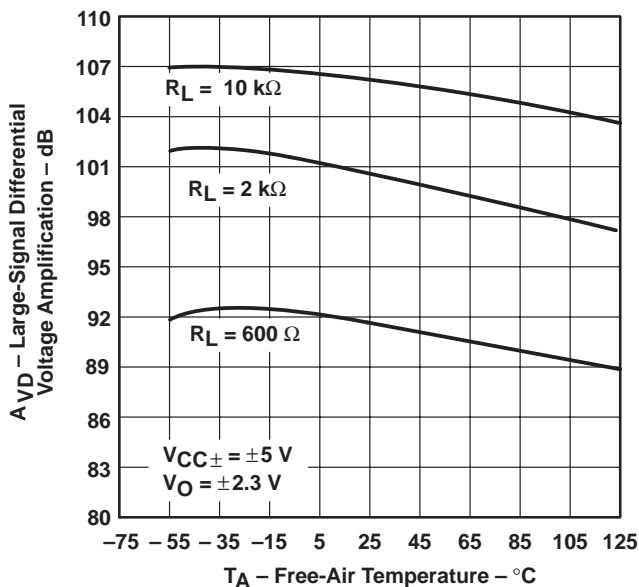

Figure 26

LARGE-SIGNAL DIFFERENTIAL  
 VOLTAGE AMPLIFICATION†  
 vs  
 FREE-AIR TEMPERATURE

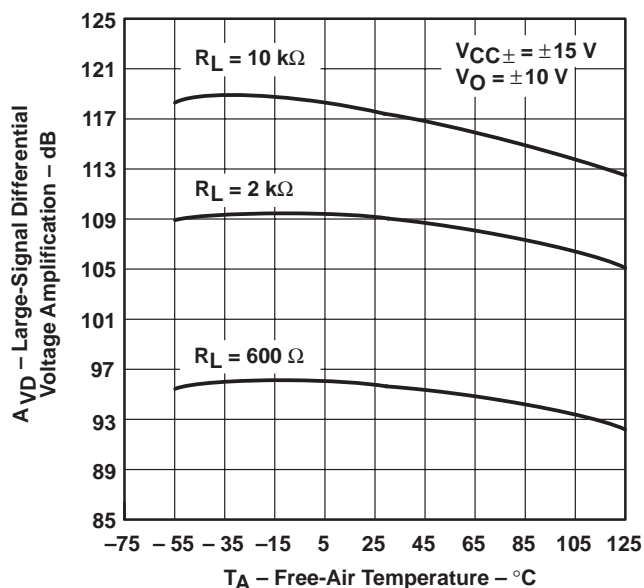

Figure 27

† Data at high and low temperatures are applicable only within the rated operating free-air temperature ranges of the various devices.



TYPICAL CHARACTERISTICS

SMALL-SIGNAL DIFFERENTIAL VOLTAGE  
 AMPLIFICATION AND PHASE SHIFT

vs

FREQUENCY

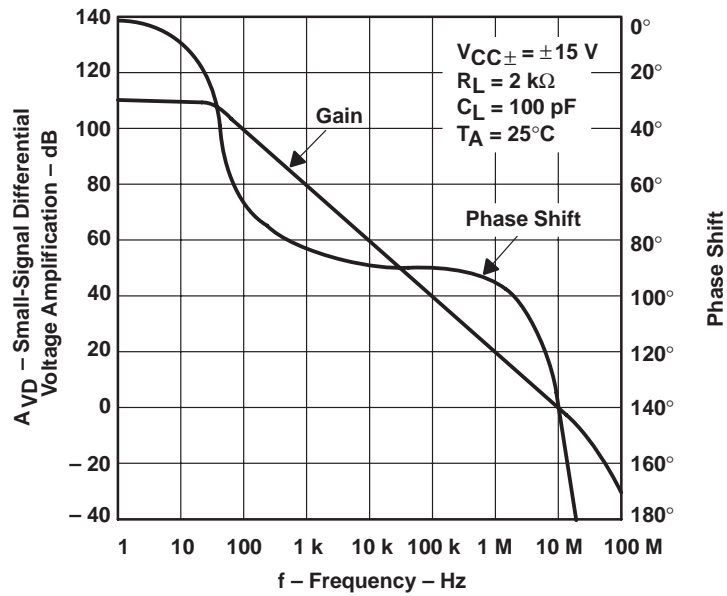

Figure 28

SMALL-SIGNAL DIFFERENTIAL VOLTAGE  
 AMPLIFICATION AND PHASE SHIFT

vs

FREQUENCY

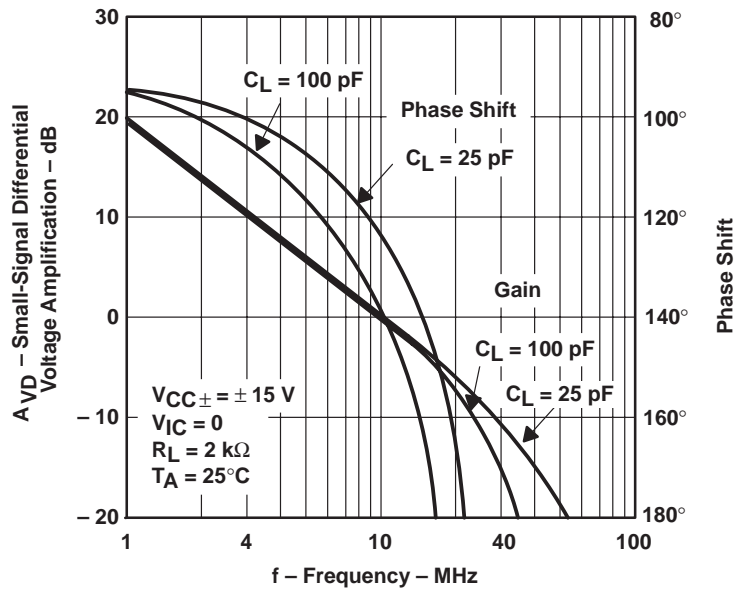
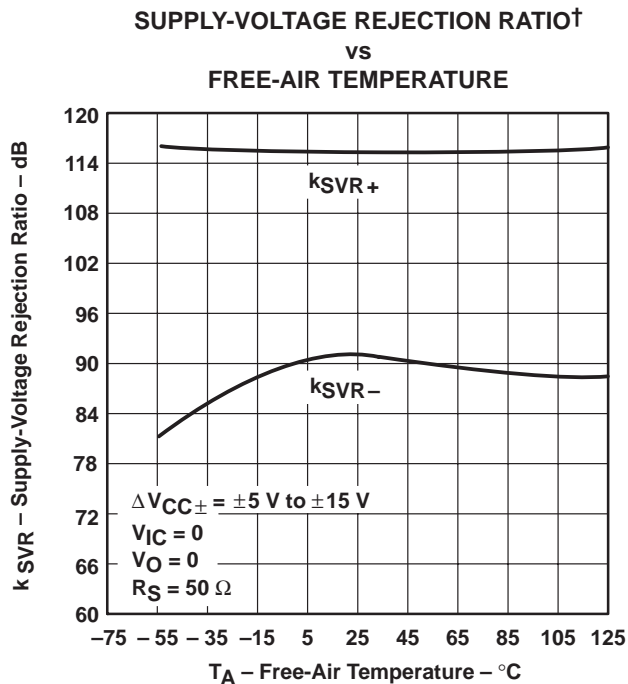
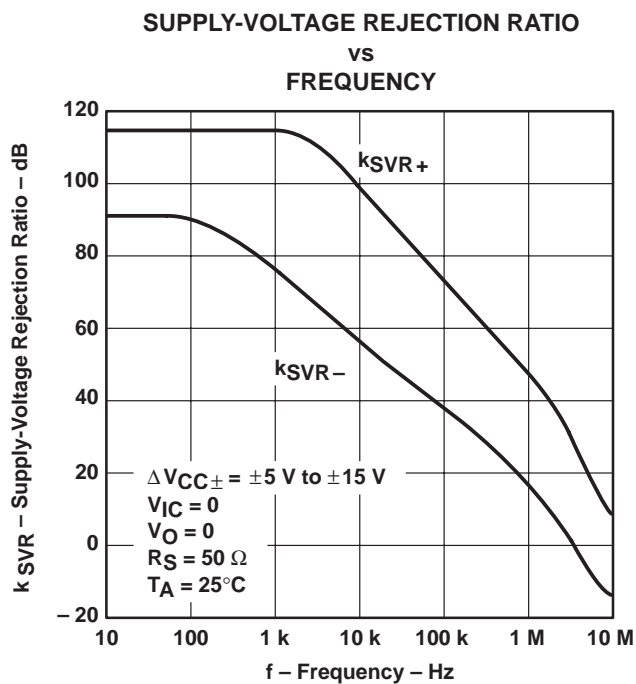
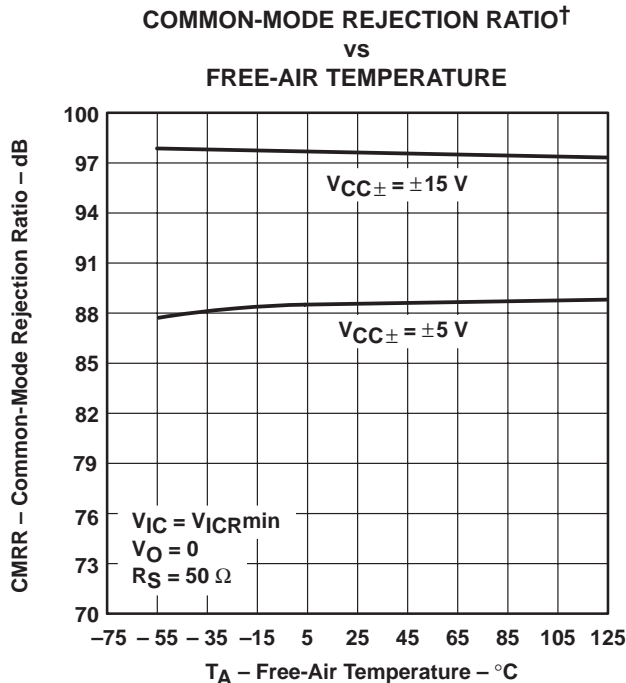
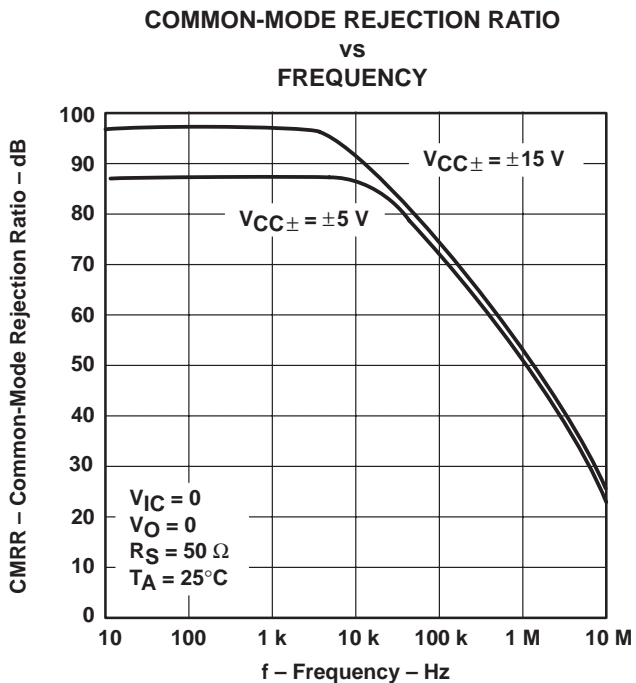

Figure 29

# TLE207x, TLE207xA, TLE207xY EXCALIBUR LOW-NOISE HIGH-SPEED JFET-INPUT OPERATIONAL AMPLIFIERS

SLOS181A – FEBRUARY 1997 – REVISED MARCH 2000

## TYPICAL CHARACTERISTICS



† Data at high and low temperatures are applicable only within the rated operating free-air temperature ranges of the various devices.

TYPICAL CHARACTERISTICS

TLE2071  
 SUPPLY CURRENT  
 vs  
 SUPPLY VOLTAGE

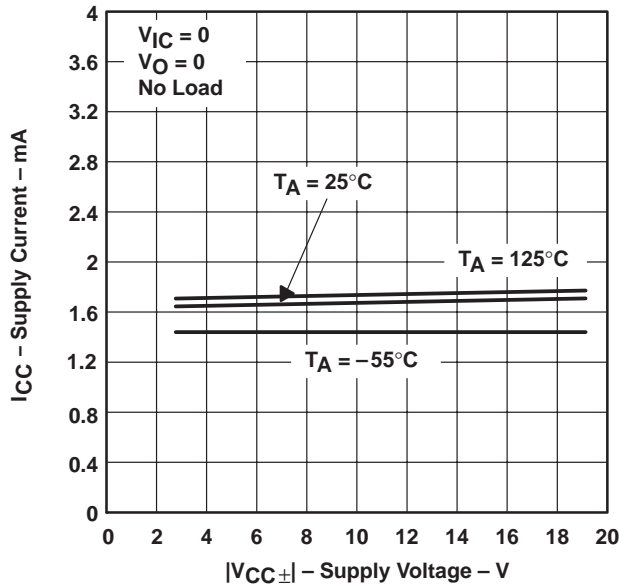

Figure 34

TLE2072  
 SUPPLY CURRENT  
 vs  
 SUPPLY VOLTAGE

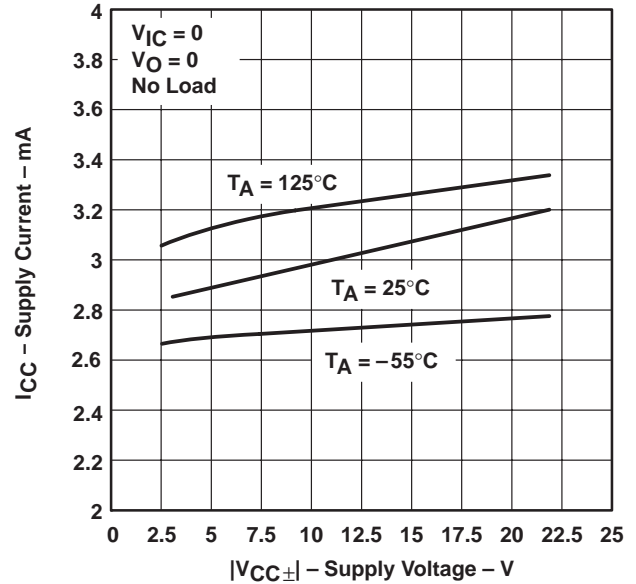

Figure 35

TLE2074  
 SUPPLY CURRENT  
 vs  
 SUPPLY VOLTAGE

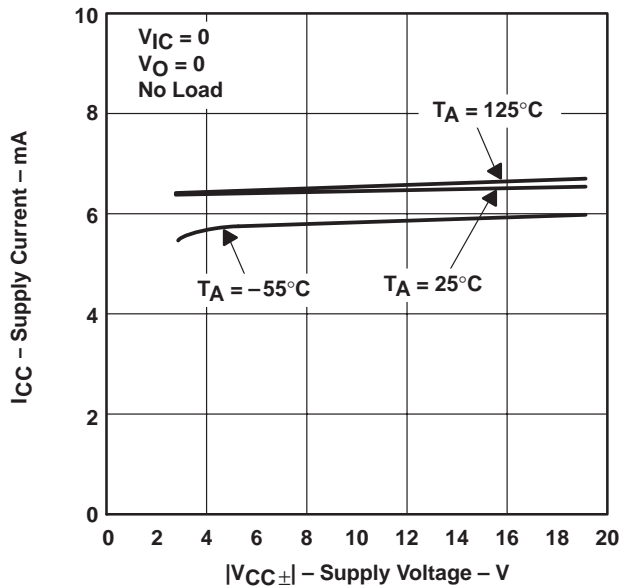

Figure 36

TLE2071  
 SUPPLY CURRENT†  
 vs  
 FREE-AIR TEMPERATURE

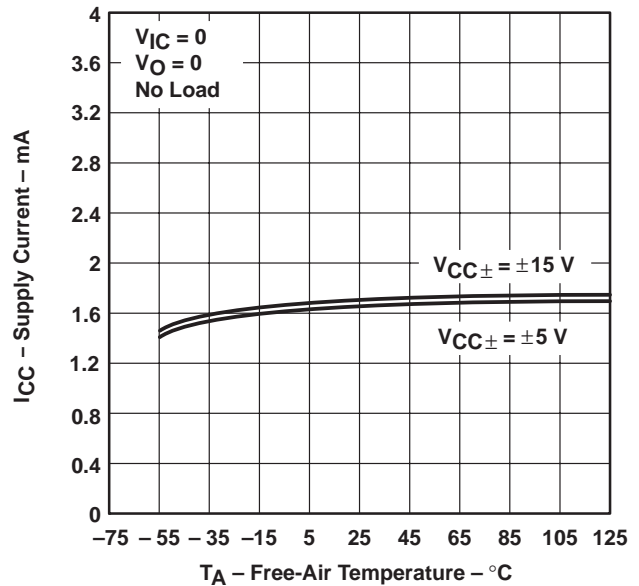

Figure 37

† Data at high and low temperatures are applicable only within the rated operating free-air temperature ranges of the various devices.

# TLE207x, TLE207xA, TLE207xY EXCALIBUR LOW-NOISE HIGH-SPEED JFET-INPUT OPERATIONAL AMPLIFIERS

SLOS181A – FEBRUARY 1997 – REVISED MARCH 2000

## TYPICAL CHARACTERISTICS

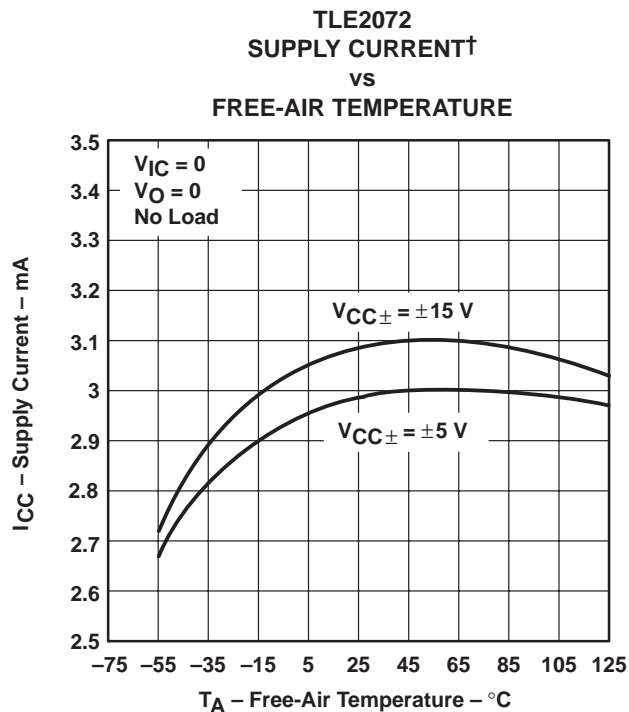

Figure 38

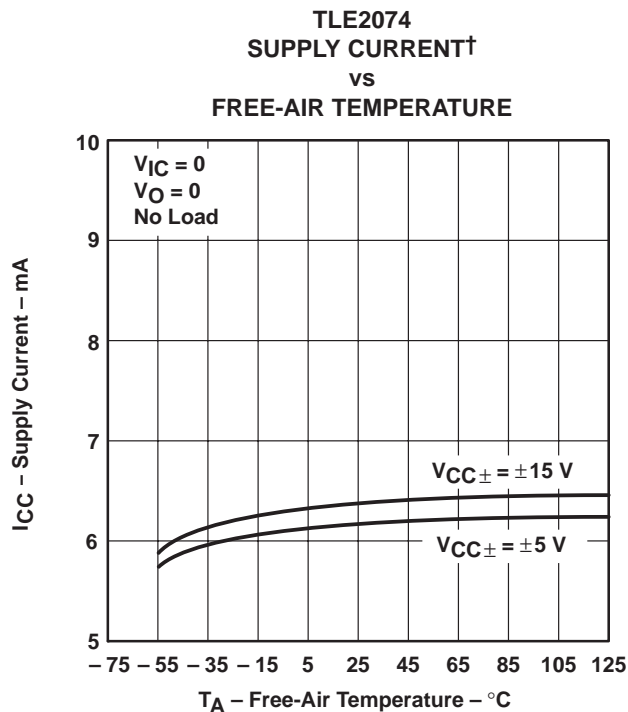

Figure 39

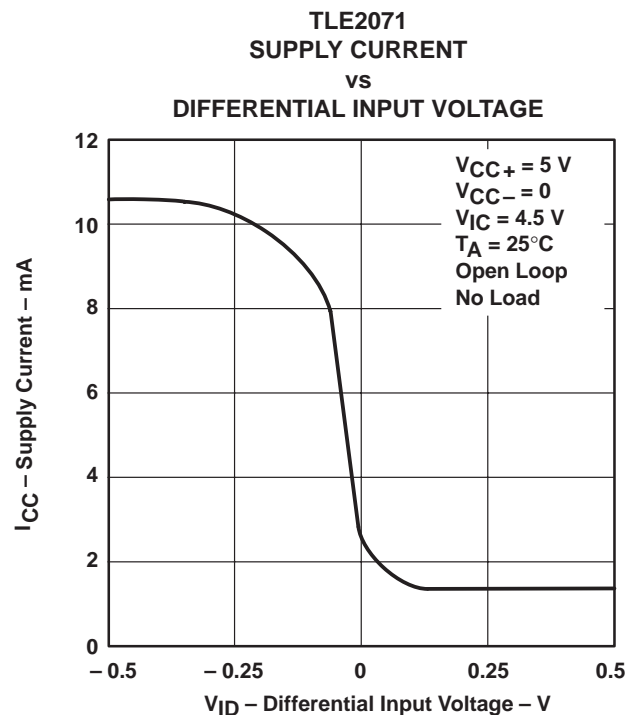

Figure 40

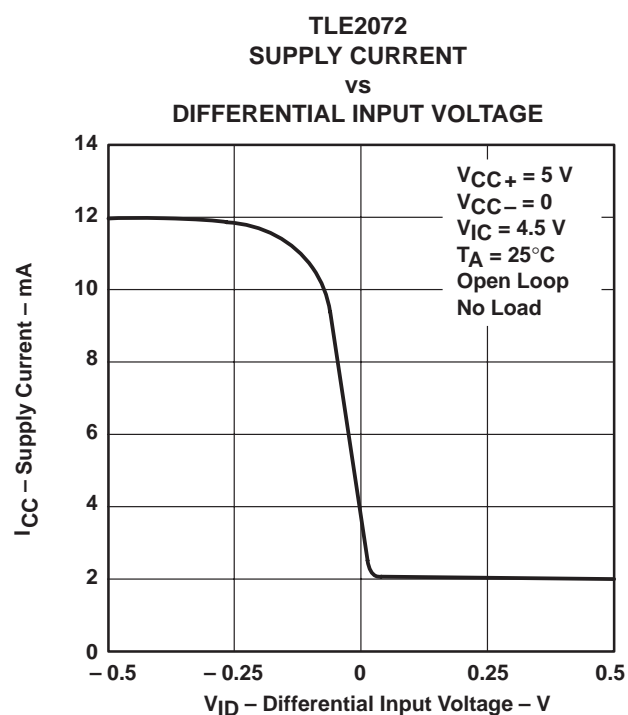

Figure 41

† Data at high and low temperatures are applicable only within the rated operating free-air temperature ranges of the various devices.

TYPICAL CHARACTERISTICS

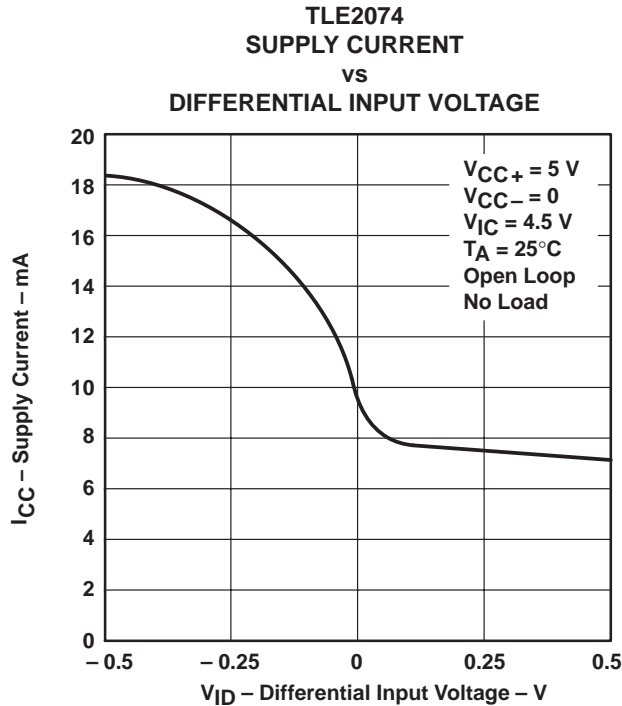

Figure 42

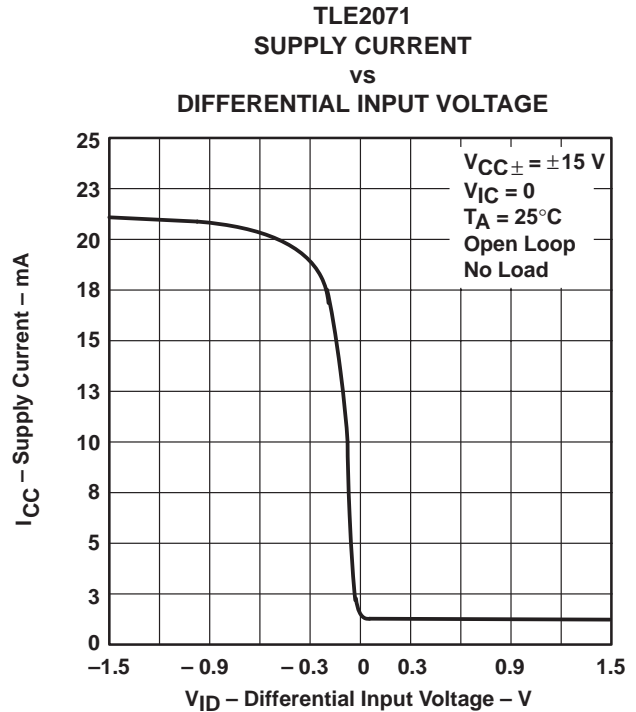

Figure 43

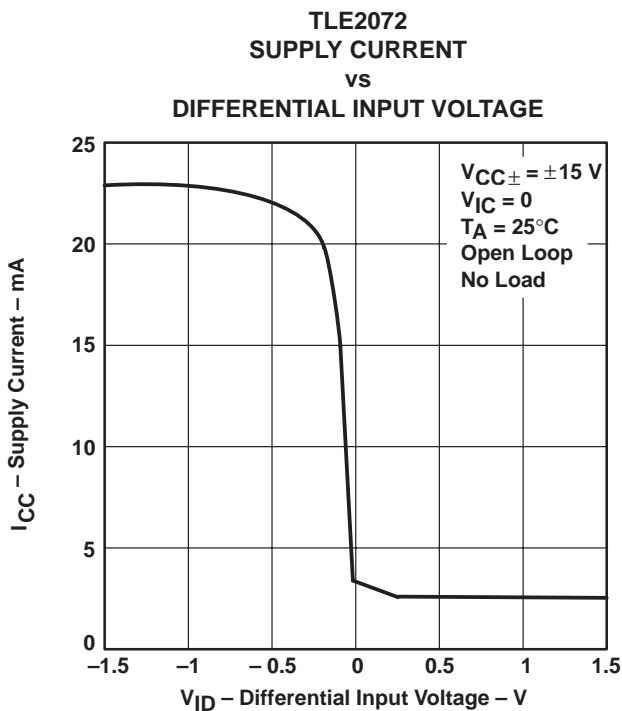

Figure 44

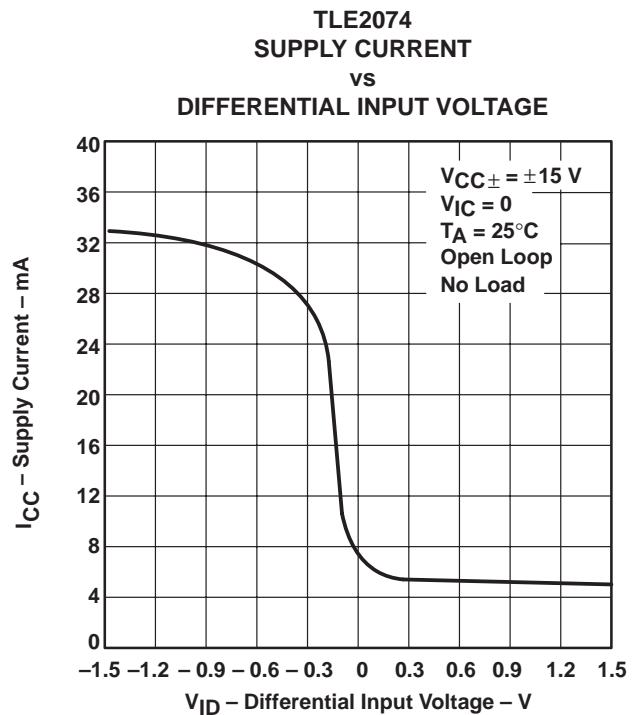

Figure 45

TLE207x, TLE207xA, TLE207xY  
 EXCALIBUR LOW-NOISE HIGH-SPEED  
 JFET-INPUT OPERATIONAL AMPLIFIERS  
 SLOS181A – FEBRUARY 1997 – REVISED MARCH 2000

TYPICAL CHARACTERISTICS

SHORT-CIRCUIT OUTPUT CURRENT  
 vs  
 SUPPLY VOLTAGE

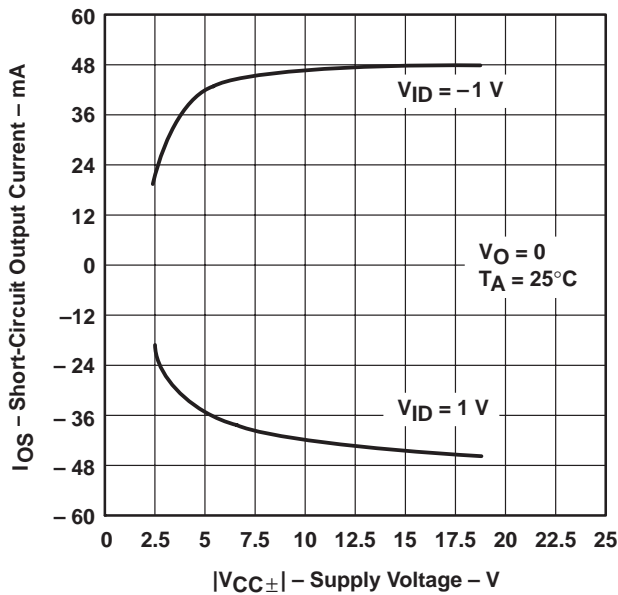

Figure 46

SHORT-CIRCUIT OUTPUT CURRENT  
 vs  
 ELAPSED TIME

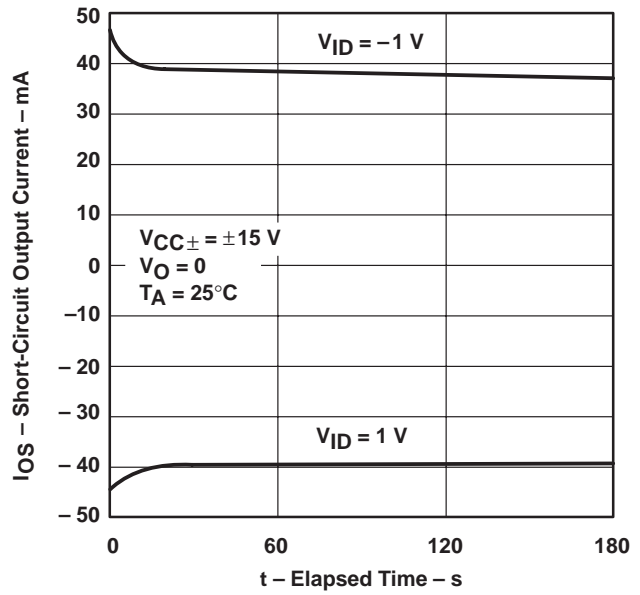

Figure 47

SHORT-CIRCUIT OUTPUT CURRENT†  
 vs  
 FREE-AIR TEMPERATURE

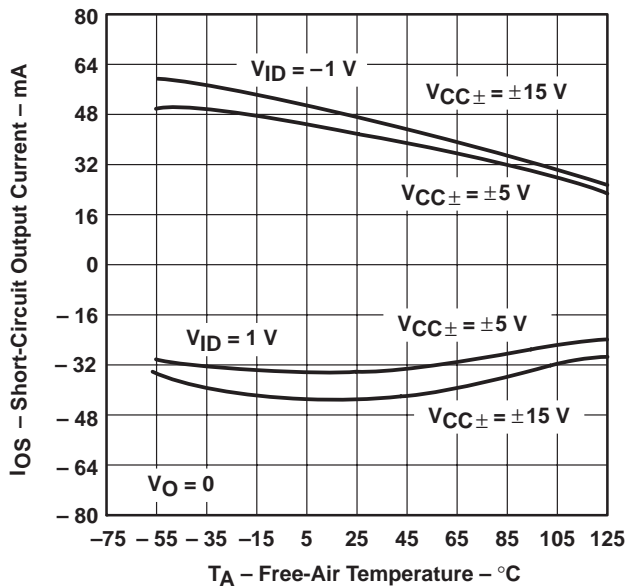

Figure 48

SLEW RATE†  
 vs  
 FREE-AIR TEMPERATURE

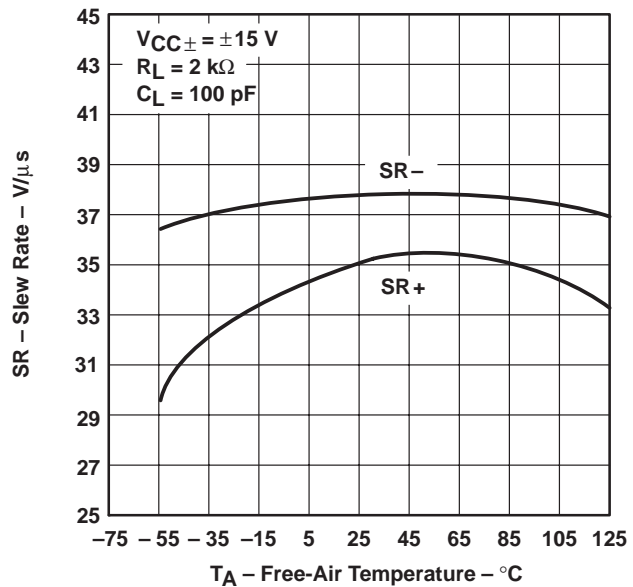

Figure 49

† Data at high and low temperatures are applicable only within the rated operating free-air temperature ranges of the various devices.

TYPICAL CHARACTERISTICS

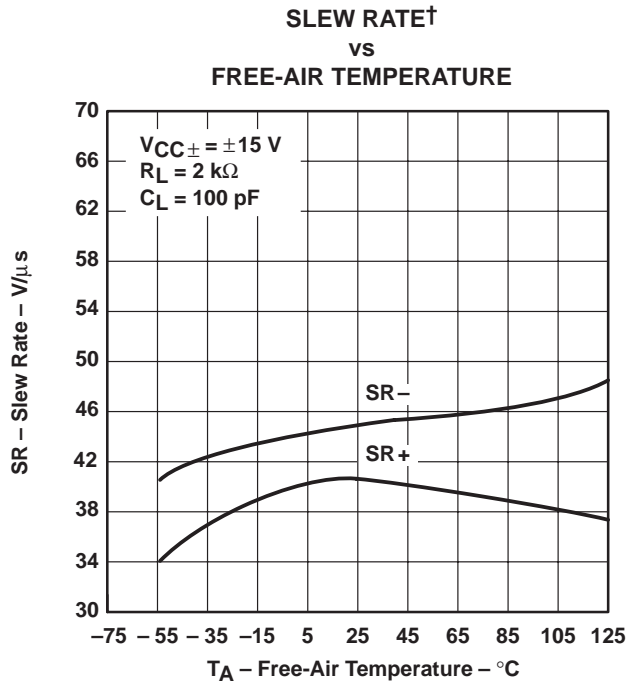

Figure 50

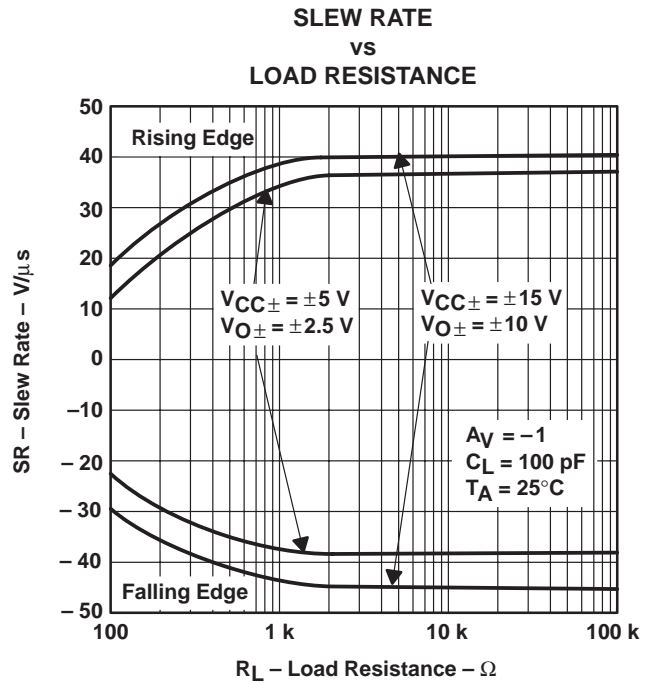

Figure 51

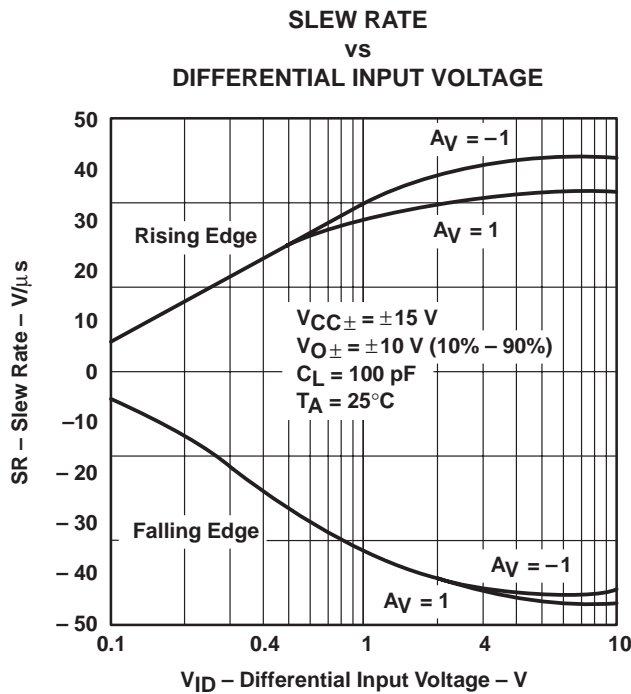

Figure 52

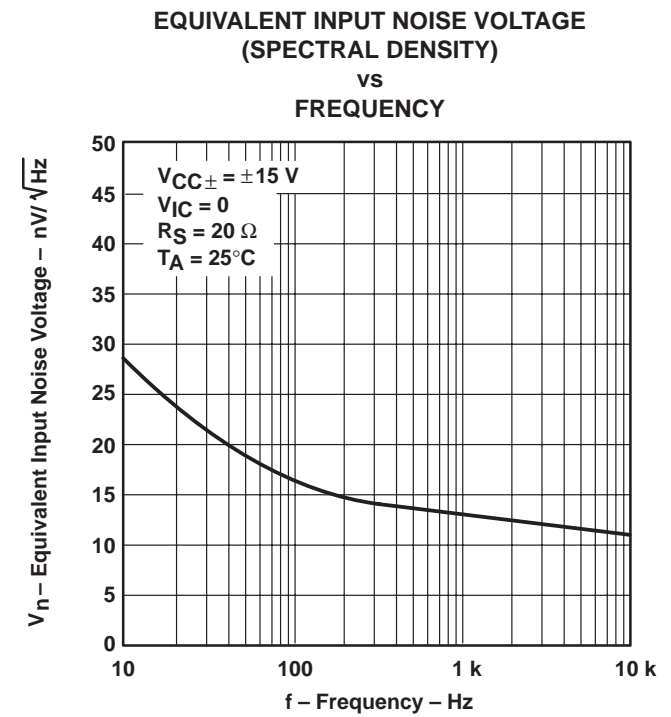

Figure 53

† Data at high and low temperatures are applicable only within the rated operating free-air temperature ranges of the various devices.

TLE207x, TLE207xA, TLE207xY  
 EXCALIBUR LOW-NOISE HIGH-SPEED  
 JFET-INPUT OPERATIONAL AMPLIFIERS

SLOS181A – FEBRUARY 1997 – REVISED MARCH 2000

TYPICAL CHARACTERISTICS

INPUT-REFERRED NOISE VOLTAGE  
 vs  
 NOISE BANDWIDTH

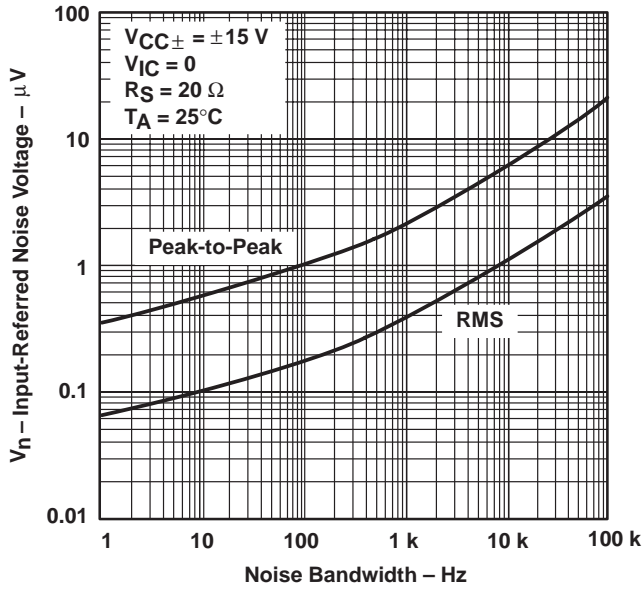

Figure 54

INPUT-REFERRED NOISE VOLTAGE  
 OVER A 10-SECOND TIME INTERVAL

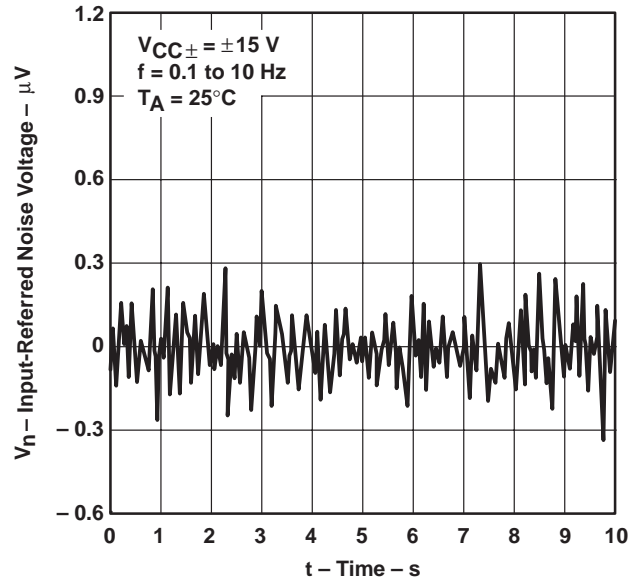

Figure 55

THIRD-OCTAVE SPECTRAL NOISE DENSITY  
 vs  
 FREQUENCY BANDS

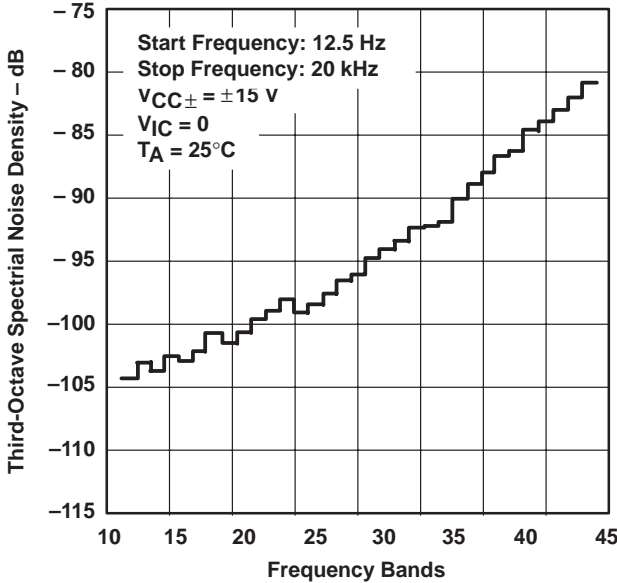

Figure 56

TOTAL HARMONIC DISTORTION PLUS NOISE  
 vs  
 FREQUENCY

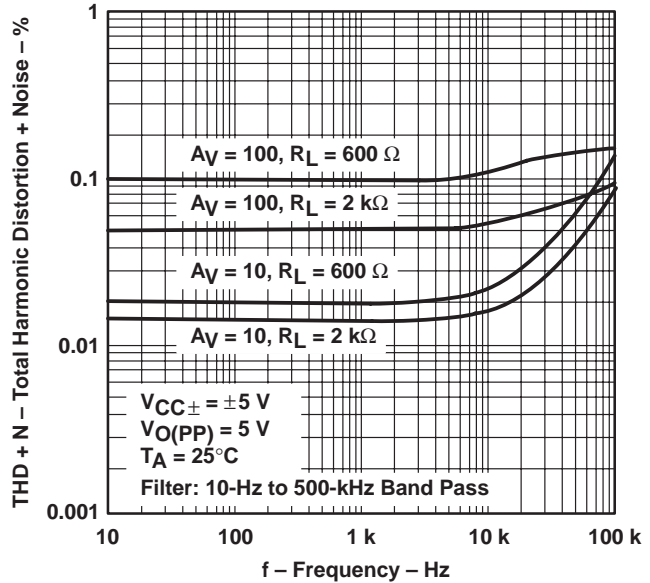

Figure 57



TYPICAL CHARACTERISTICS

TOTAL HARMONIC DISTORTION PLUS NOISE  
 VS  
 FREQUENCY

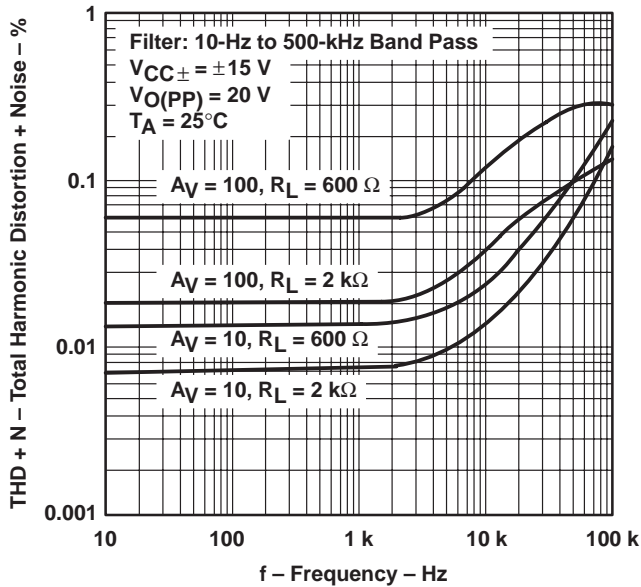

Figure 58

UNITY-GAIN BANDWIDTH  
 VS  
 LOAD CAPACITANCE

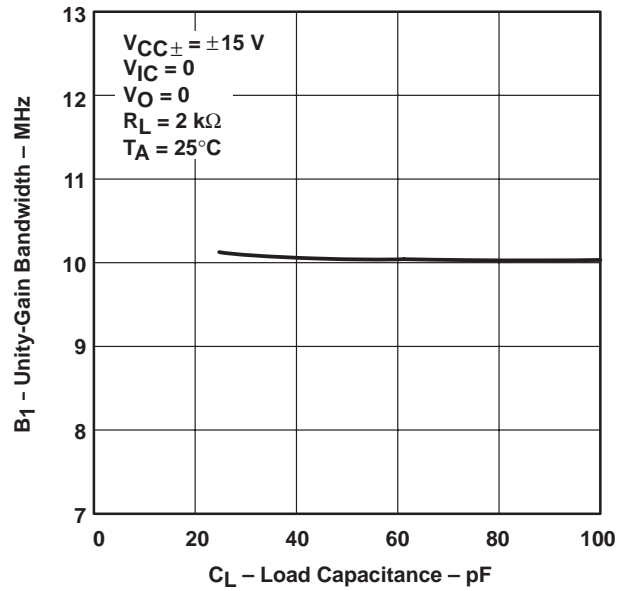

Figure 59

GAIN-BANDWIDTH PRODUCT†  
 VS  
 FREE-AIR TEMPERATURE

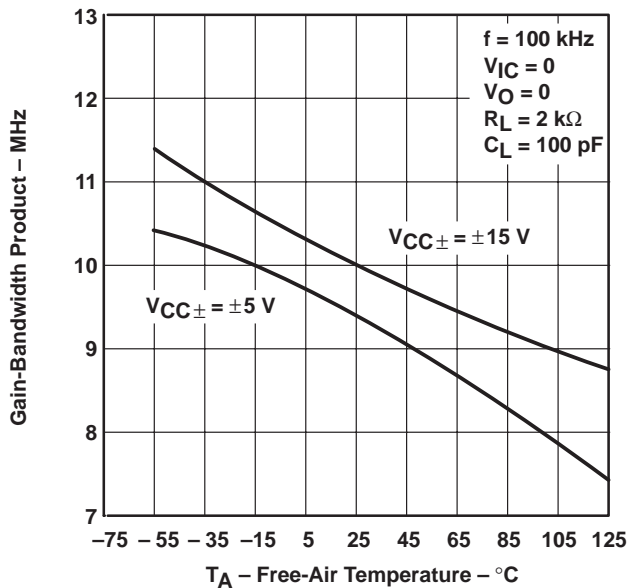

Figure 60

GAIN-BANDWIDTH PRODUCT  
 VS  
 SUPPLY VOLTAGE

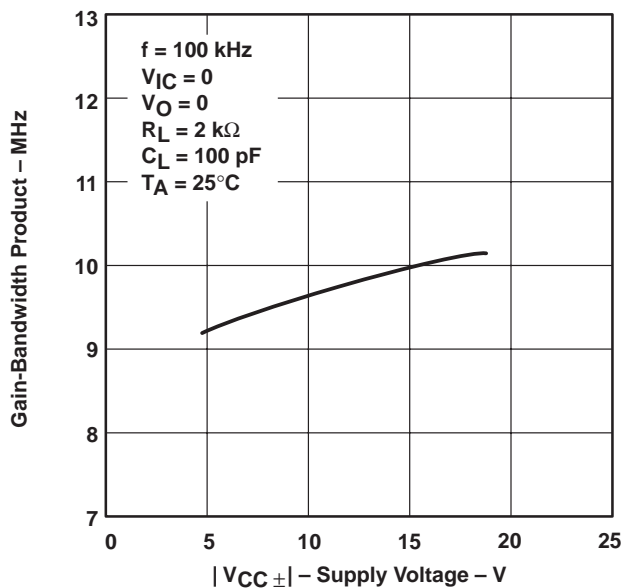

Figure 61

† Data at high and low temperatures are applicable only within the rated operating free-air temperature ranges of the various devices.

# TLE207x, TLE207xA, TLE207xY EXCALIBUR LOW-NOISE HIGH-SPEED JFET-INPUT OPERATIONAL AMPLIFIERS

SLOS181A – FEBRUARY 1997 – REVISED MARCH 2000

## TYPICAL CHARACTERISTICS

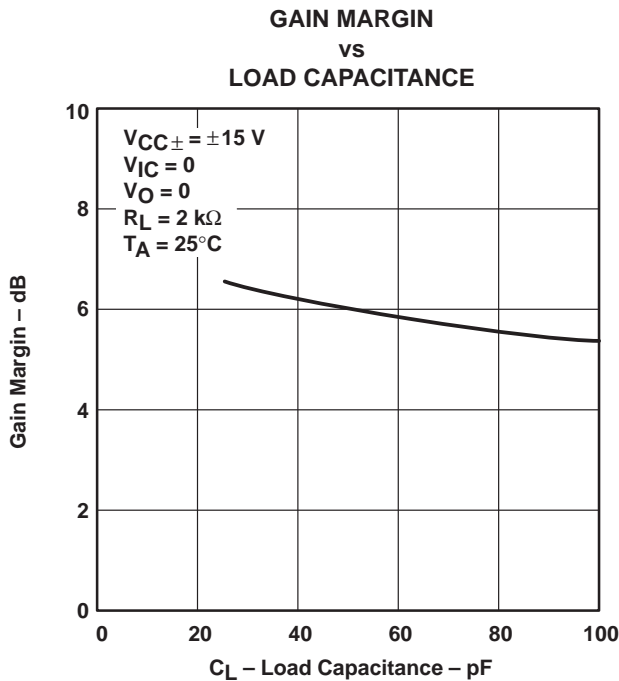

Figure 62

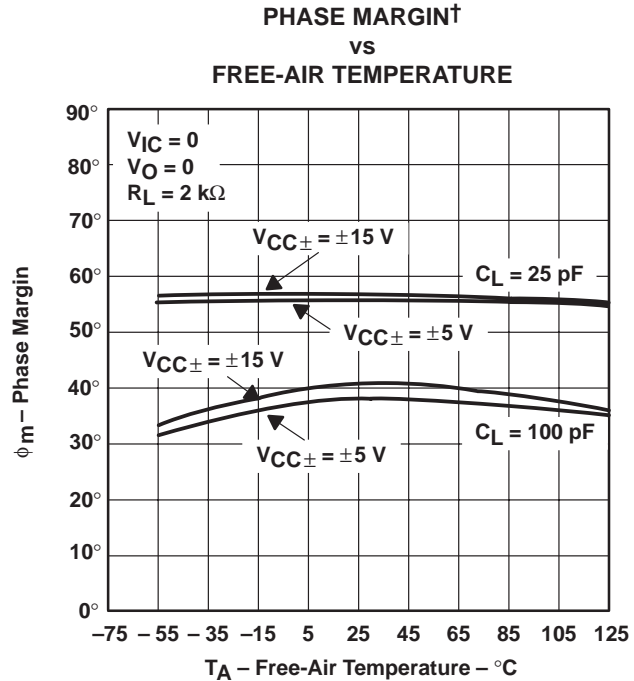

Figure 63

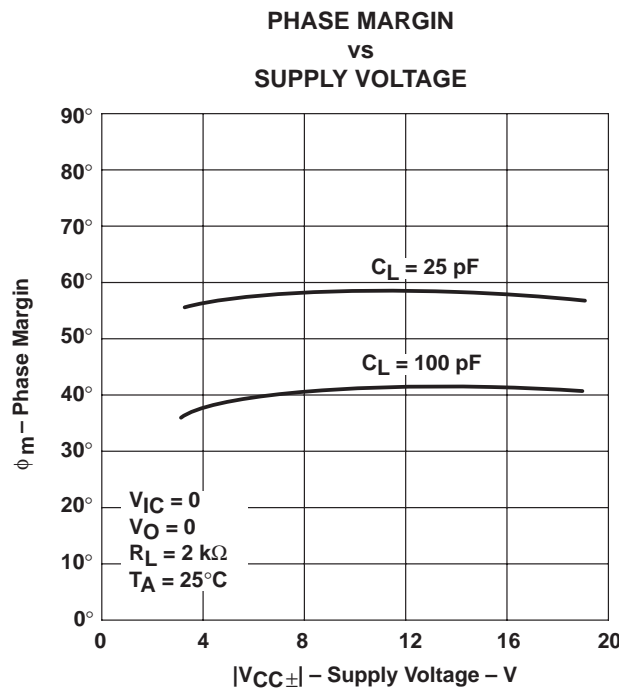

Figure 64

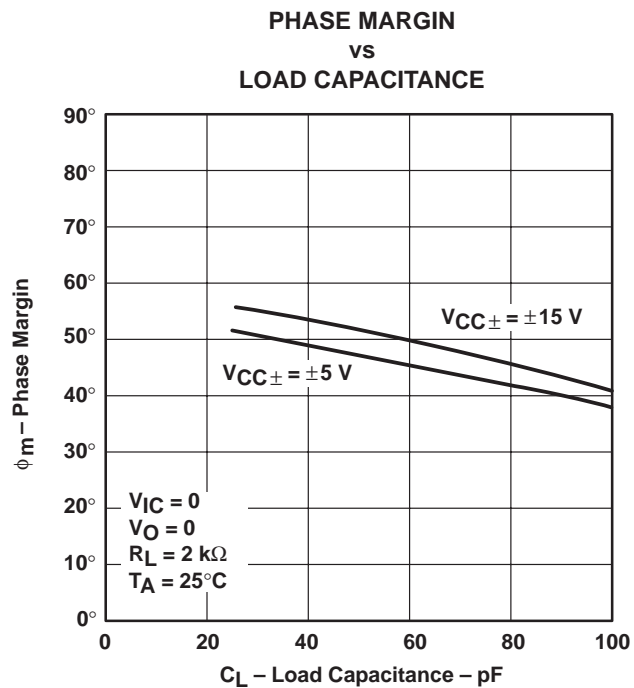

Figure 65

† Data at high and low temperatures are applicable only within the rated operating free-air temperature ranges of the various devices.

TYPICAL CHARACTERISTICS

NONINVERTING LARGE-SIGNAL  
 PULSE RESPONSE†

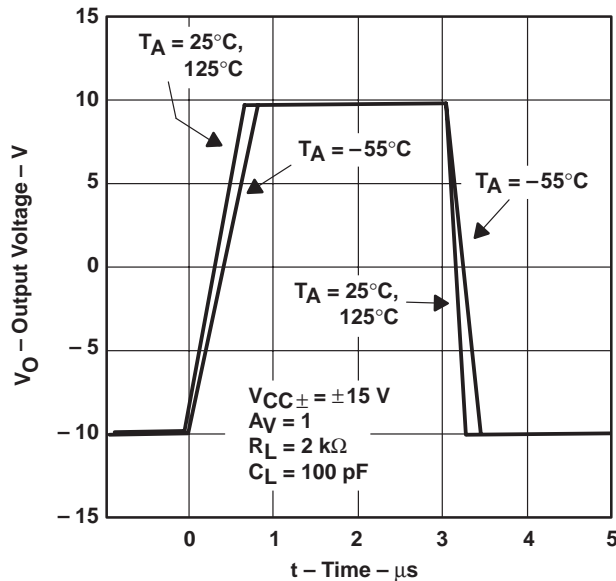

Figure 66

SMALL-SIGNAL PULSE RESPONSE

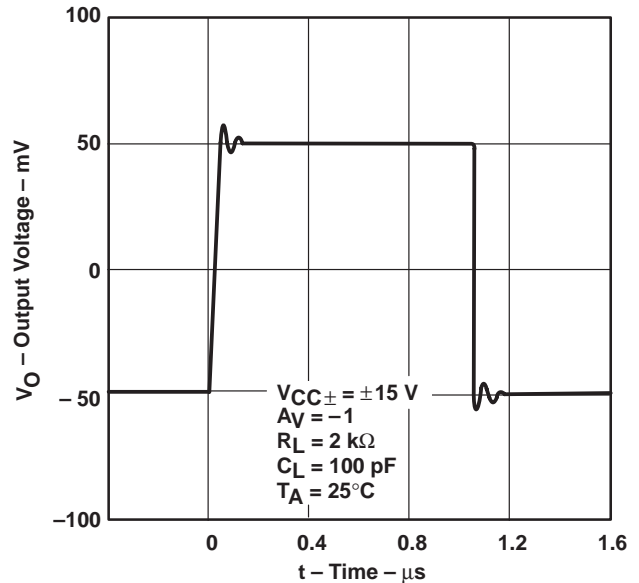

Figure 67

CLOSED-LOOP OUTPUT IMPEDANCE  
 VS  
 FREQUENCY

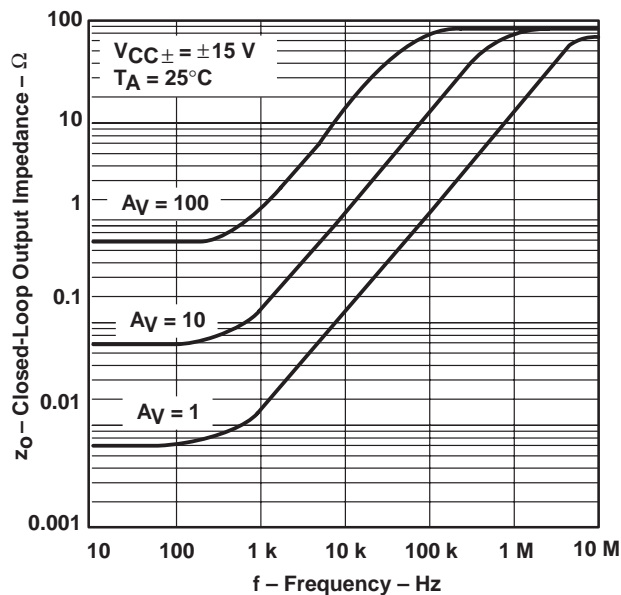

Figure 68

TLE2072 AND TLE2074  
 CROSSTALK ATTENUATION  
 VS  
 FREQUENCY

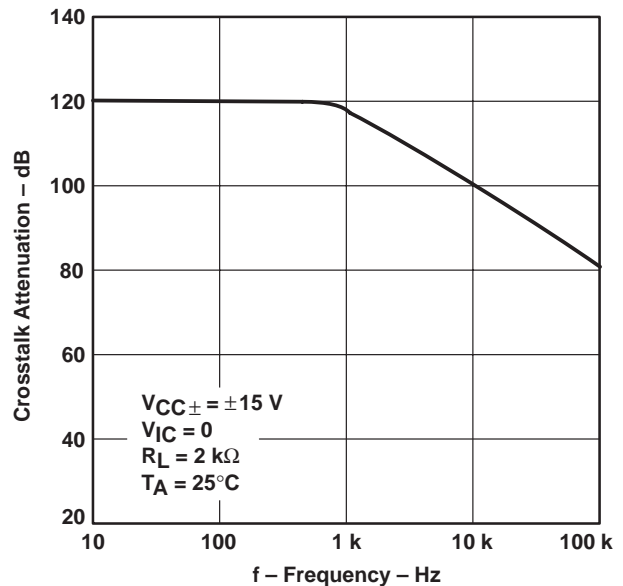

Figure 69

† Data at high and low temperatures are applicable only within the rated operating free-air temperature ranges of the various devices.

**TLE207x, TLE207xA, TLE207xY**  
**EXCALIBUR LOW-NOISE HIGH-SPEED**  
**JFET-INPUT OPERATIONAL AMPLIFIERS**

SLOS181A – FEBRUARY 1997 – REVISED MARCH 2000

**APPLICATION INFORMATION**

**input characteristics**

The TLE207x, TLE207xA, and TLE207xB are specified with a minimum and a maximum input voltage that if exceeded at either input could cause the device to malfunction. Because of the extremely high input impedance and resulting low bias current requirements, the TLE207x, TLE207xA, and TLE207xB are well suited for low-level signal processing; however, leakage currents on printed-circuit boards and sockets can easily exceed bias current requirements and cause degradation in system performance. It is good practice to include guard rings around inputs (see Figure 70). These guards should be driven from a low-impedance source at the same voltage level as the common-mode input.

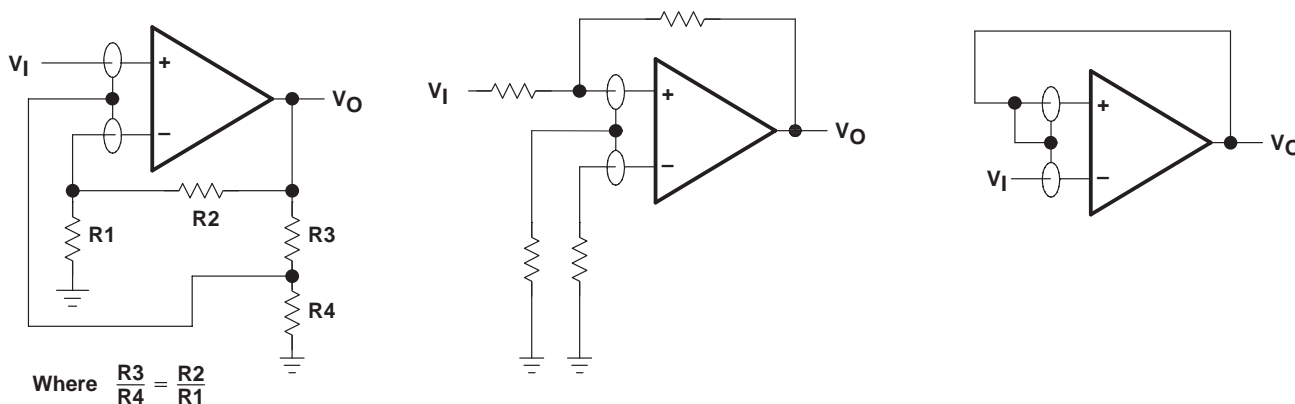

**Figure 70. Use of Guard Rings**

**TLE2071 input offset voltage nulling**

The TLE2071 series offers external null pins that can be used to further reduce the input offset voltage. The circuit of Figure 71 can be connected as shown if the feature is desired. When external nulling is not needed, the null pins may be left unconnected.

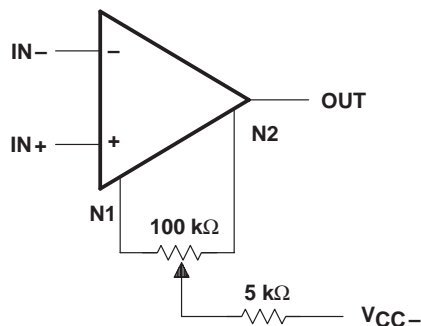

**Figure 71. Input Offset Voltage Nulling**

**TLE207x, TLE207xA, TLE207xY**  
**EXCALIBUR LOW-NOISE HIGH-SPEED**  
**JFET-INPUT OPERATIONAL AMPLIFIERS**  
 SLOS181A – FEBRUARY 1997 – REVISED MARCH 2000

**APPLICATION INFORMATION**

**macromodel information**

Macromodel information provided was derived using *PSpice™ Parts™* model generation software. The Boyle macromodel (see Note 4) and subcircuit Figure 72 were generated using the TLE207x typical electrical and operating characteristics at  $T_A = 25^\circ\text{C}$ . Using this information, output simulations of the following key parameters can be generated to a tolerance of 20% (in most cases):

- Maximum positive output voltage swing
- Maximum negative output voltage swing
- Slew rate
- Quiescent power dissipation
- Input bias current
- Open-loop voltage amplification
- Unity-gain frequency
- Common-mode rejection ratio
- Phase margin
- DC output resistance
- AC output resistance
- Short-circuit output current limit

NOTE 4: G.R. Boyle, B.M. Cohn, D. O. Pederson, and J. E. Solomon, "Macromodeling of Integrated Circuit Operational Amplifiers", *IEEE Journal of Solid-State Circuits*, SC-9, 353 (1974).

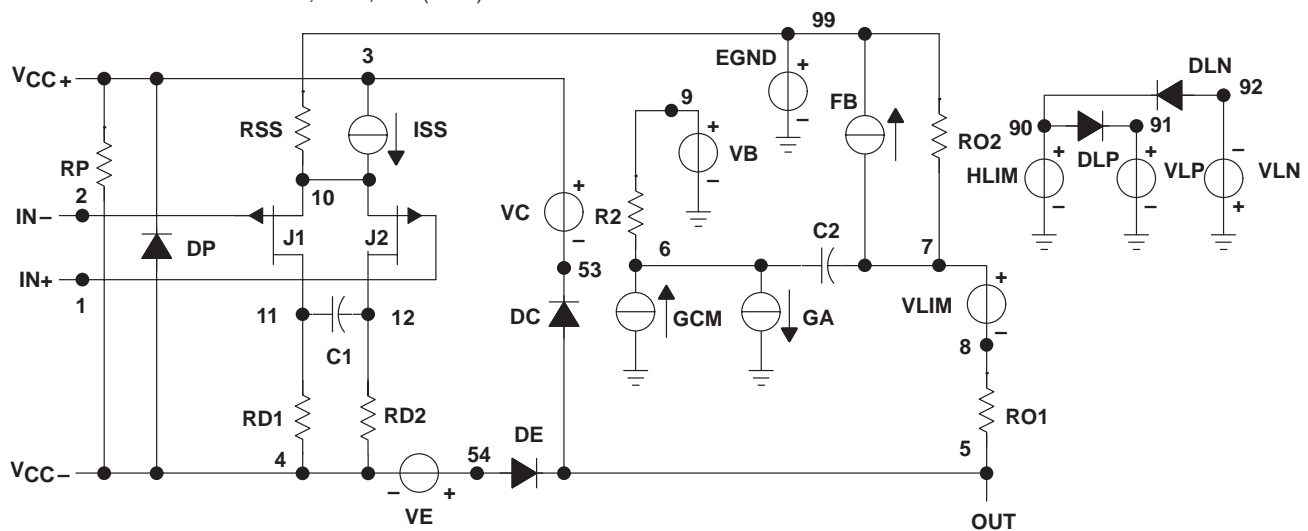

```
.SUBCKT TLE2074 1 2 3 4 5
C1      11      12      2.2E-12
C2      6       7       10.00E-12
DC      5       53      DX
DE      54      5       DX
DLP     90      91      DX
DLN     92      90      DX
DP      4       3       DX
EGND    99      0       POLY (2) (3,0) (4,0) 0 .5 .5
FB      7       99      POLY (5) VB VC VE VLP VLN 0
+ 5.607E6 -6E6 6E6 6E6 -6E6
GA      6       0       11 12 333.0E-6
GCM     0       6       10 99 7.43E-9
ISS     3       10      DC 400.0E-6
HLIM    90      0       VLIM 1K
J1      11      2       10 JX
J2      12      1       10 JX

R2      6       9       100.0E3
RD1     4       11      3.003E3
RD2     4       12      3.003E3
R01     8       5       80
R02     7       99      80
RP      3       4       27.30E3
RSS     10      99      500.0E3
VB      9       0       DC 0
VC      3       53      DC 2.20
VE      54      4       DC 2.20
VLIM    7       8       DC 0
VLP     91      0       DC 45
VLN     0       92      DC 45
.MODEL DX D (IS=800.0E-18)
.MODEL JX PJF (IS=15.00E-12 BETA=554.5E-6
+ VTO=-.6)
.ENDS
```

**Figure 72. Boyle Macromodel and Subcircuit**

**TLE207x, TLE207xA, TLE207xY**  
**EXCALIBUR LOW-NOISE HIGH-SPEED**  
**JFET-INPUT OPERATIONAL AMPLIFIERS**

SLOS181A – FEBRUARY 1997 – REVISED MARCH 2000

**MECHANICAL INFORMATION**

**D (R-PDSO-G\*\*)**

**PLASTIC SMALL-OUTLINE PACKAGE**

14 PIN SHOWN

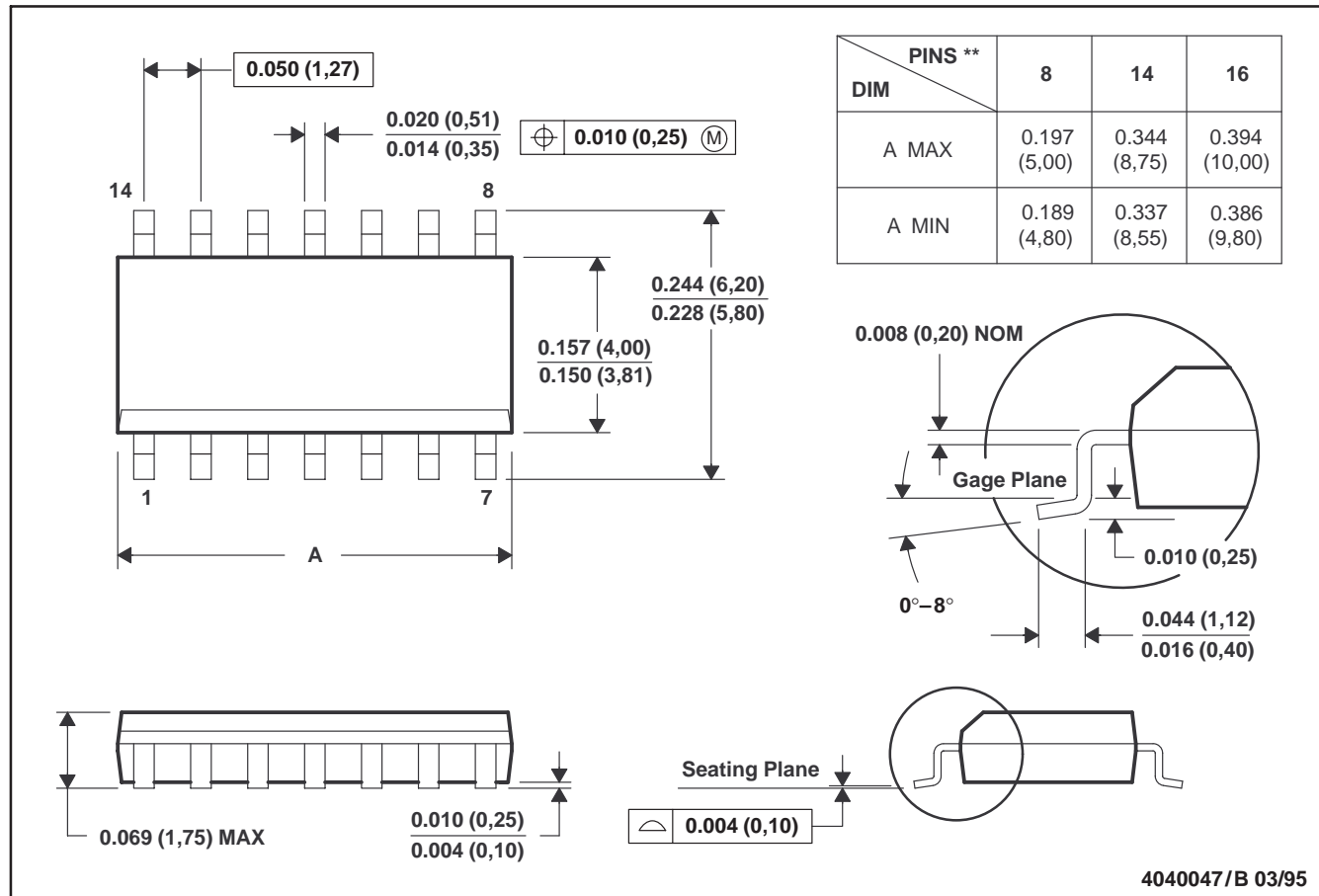

- NOTES: A. All linear dimensions are in inches (millimeters).  
 B. This drawing is subject to change without notice.  
 C. Body dimensions do not include mold flash or protrusion, not to exceed 0.006 (0,15).  
 D. Four center pins are connected to die mount pad.  
 E. Falls within JEDEC MS-012

# TLE207x, TLE207xA, TLE207xY EXCALIBUR LOW-NOISE HIGH-SPEED JFET-INPUT OPERATIONAL AMPLIFIERS

SLOS181A – FEBRUARY 1997 – REVISED MARCH 2000

## MECHANICAL INFORMATION

DW (R-PDSO-G\*\*)

PLASTIC SMALL-OUTLINE PACKAGE

16 PIN SHOWN

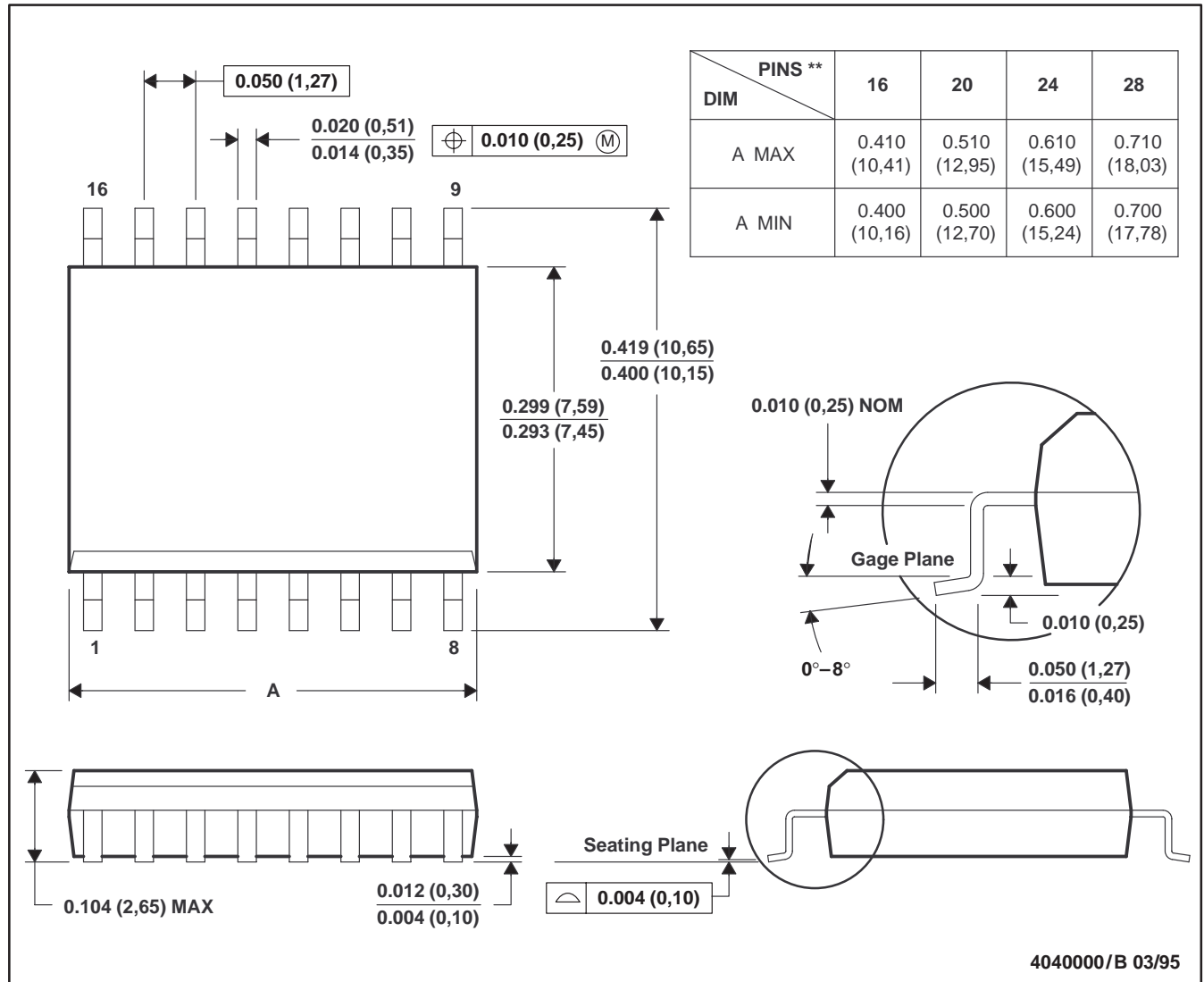

- NOTES:
- All linear dimensions are in inches (millimeters).
  - This drawing is subject to change without notice.
  - Body dimensions do not include mold flash or protrusion not to exceed 0.006 (0,15).
  - Falls within JEDEC MS-013

**TLE207x, TLE207xA, TLE207xY**  
**EXCALIBUR LOW-NOISE HIGH-SPEED**  
**JFET-INPUT OPERATIONAL AMPLIFIERS**

SLOS181A – FEBRUARY 1997 – REVISED MARCH 2000

**MECHANICAL INFORMATION**

**FK (S-CQCC-N\*\*)**

**LEADLESS CERAMIC CHIP CARRIER**

28 TERMINAL SHOWN

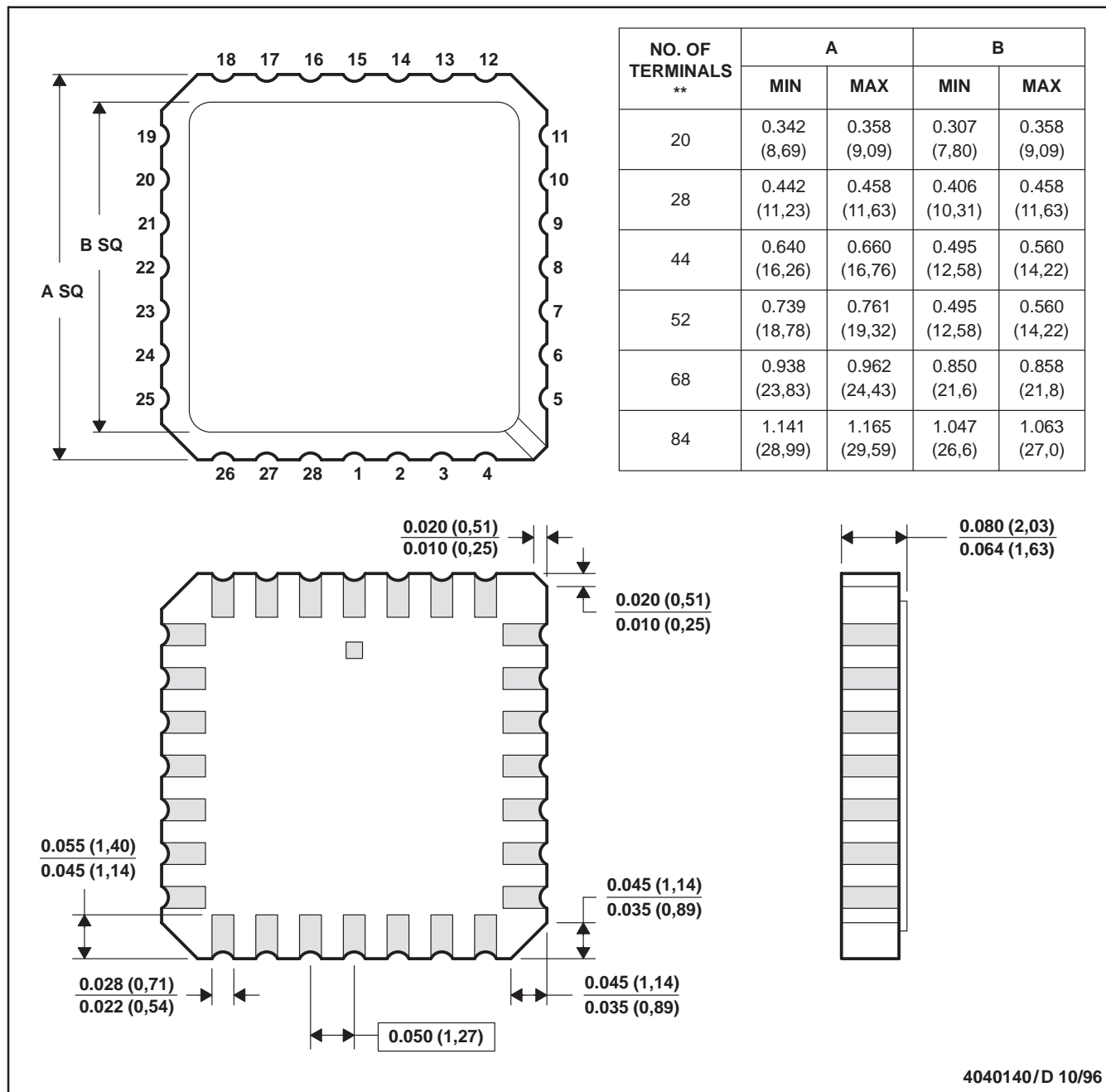

- NOTES: A. All linear dimensions are in inches (millimeters).  
 B. This drawing is subject to change without notice.  
 C. This package can be hermetically sealed with a metal lid.  
 D. The terminals are gold plated.  
 E. Falls within JEDEC MS-004



# TLE207x, TLE207xA, TLE207xY EXCALIBUR LOW-NOISE HIGH-SPEED JFET-INPUT OPERATIONAL AMPLIFIERS

SLOS181A – FEBRUARY 1997 – REVISED MARCH 2000

## MECHANICAL INFORMATION

**J (R-GDIP-T\*\*)**

**CERAMIC DUAL-IN-LINE PACKAGE**

14 PIN SHOWN

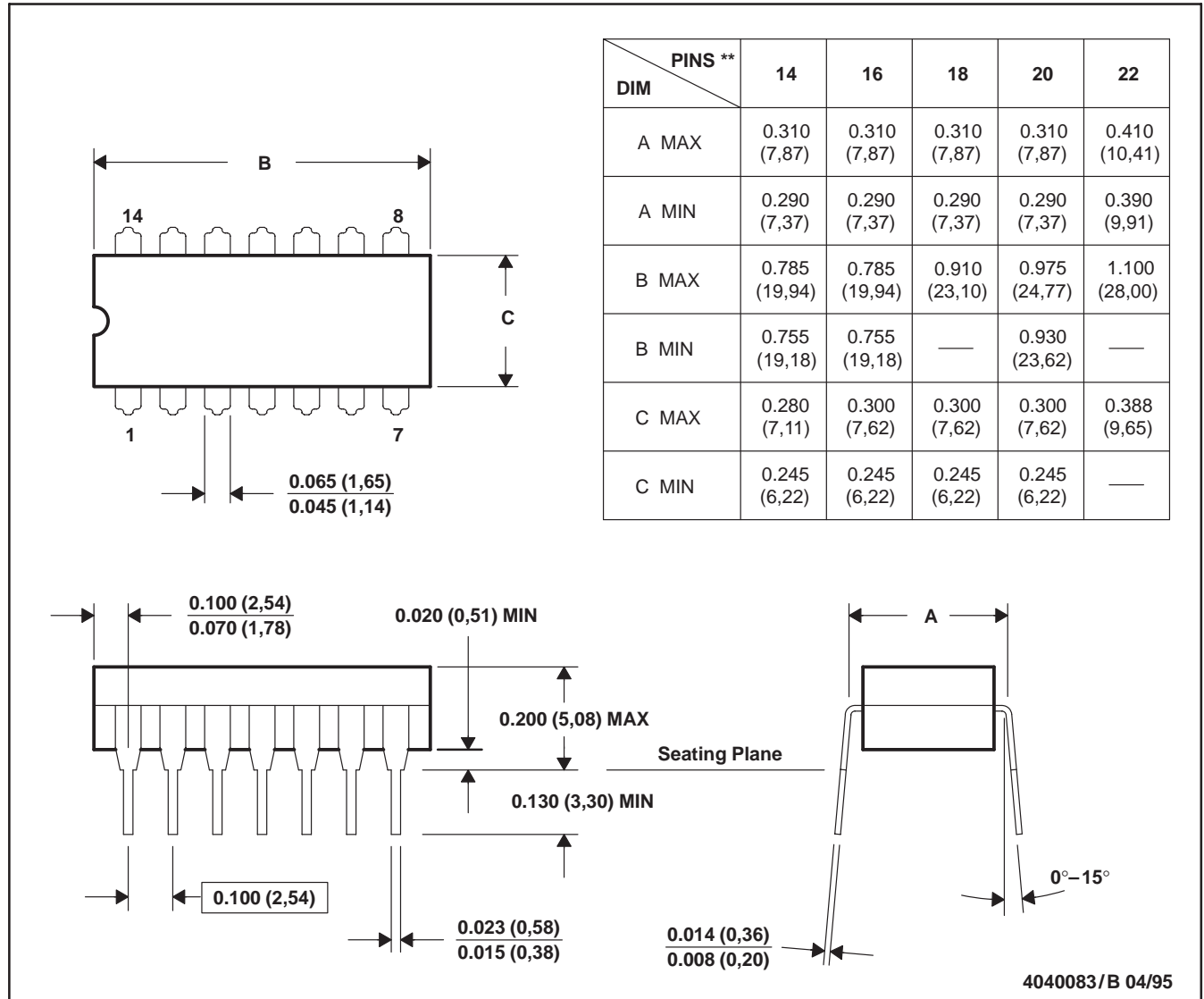

- NOTES:
- A. All linear dimensions are in inches (millimeters).
  - B. This drawing is subject to change without notice.
  - C. This package can be hermetically sealed with a ceramic lid using glass frit.
  - D. Index point is provided on cap for terminal identification only on press ceramic glass frit seal only.
  - E. Falls within MIL-STD-1835 GDIP1-T14, GDIP1-T16, GDIP1-T18, GDIP1-T20, and GDIP1-T22

**TLE207x, TLE207xA, TLE207xY**  
**EXCALIBUR LOW-NOISE HIGH-SPEED**  
**JFET-INPUT OPERATIONAL AMPLIFIERS**

SLOS181A – FEBRUARY 1997 – REVISED MARCH 2000

**MECHANICAL INFORMATION**

**JG (R-GDIP-T8)**

**CERAMIC DUAL-IN-LINE PACKAGE**

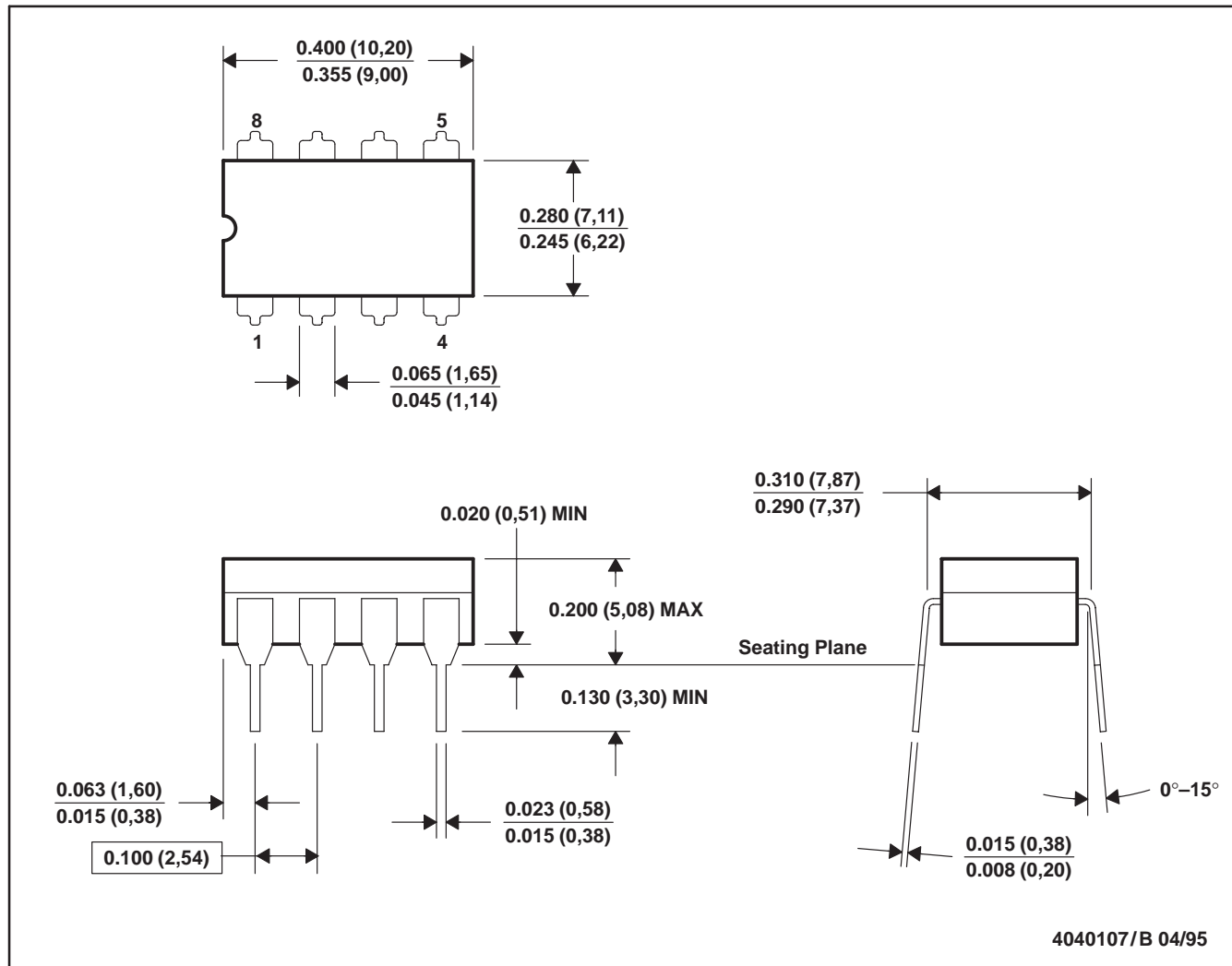

- NOTES: A. All linear dimensions are in inches (millimeters).  
 B. This drawing is subject to change without notice.  
 C. This package can be hermetically sealed with a ceramic lid using glass frit.  
 D. Index point is provided on cap for terminal identification only on press ceramic glass frit seal only  
 E. Falls within MIL-STD-1835 GDIP1-T8

**TLE207x, TLE207xA, TLE207xY**  
**EXCALIBUR LOW-NOISE HIGH-SPEED**  
**JFET-INPUT OPERATIONAL AMPLIFIERS**  
 SLOS181A – FEBRUARY 1997 – REVISED MARCH 2000

**MECHANICAL INFORMATION**

**N (R-PDIP-T\*\*)**

**PLASTIC DUAL-IN-LINE PACKAGE**

16 PIN SHOWN

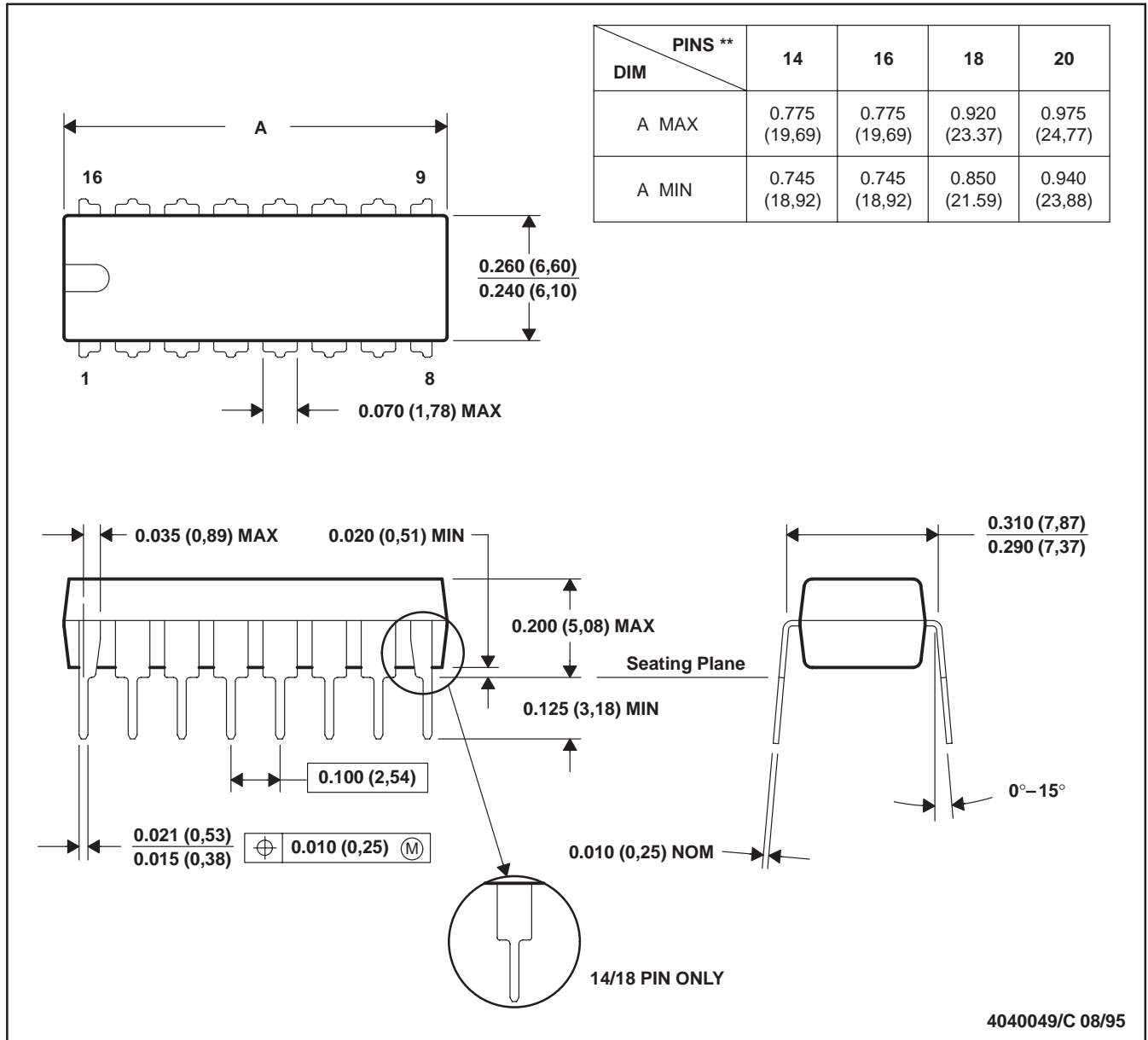

- NOTES: A. All linear dimensions are in inches (millimeters).  
 B. This drawing is subject to change without notice.  
 C. Falls within JEDEC MS-001 (20 pin package is shorter than MS-001.)

**TLE207x, TLE207xA, TLE207xY**  
**EXCALIBUR LOW-NOISE HIGH-SPEED**  
**JFET-INPUT OPERATIONAL AMPLIFIERS**

SLOS181A – FEBRUARY 1997 – REVISED MARCH 2000

**MECHANICAL INFORMATION**

**P (R-PDIP-T8)**

**PLASTIC DUAL-IN-LINE PACKAGE**

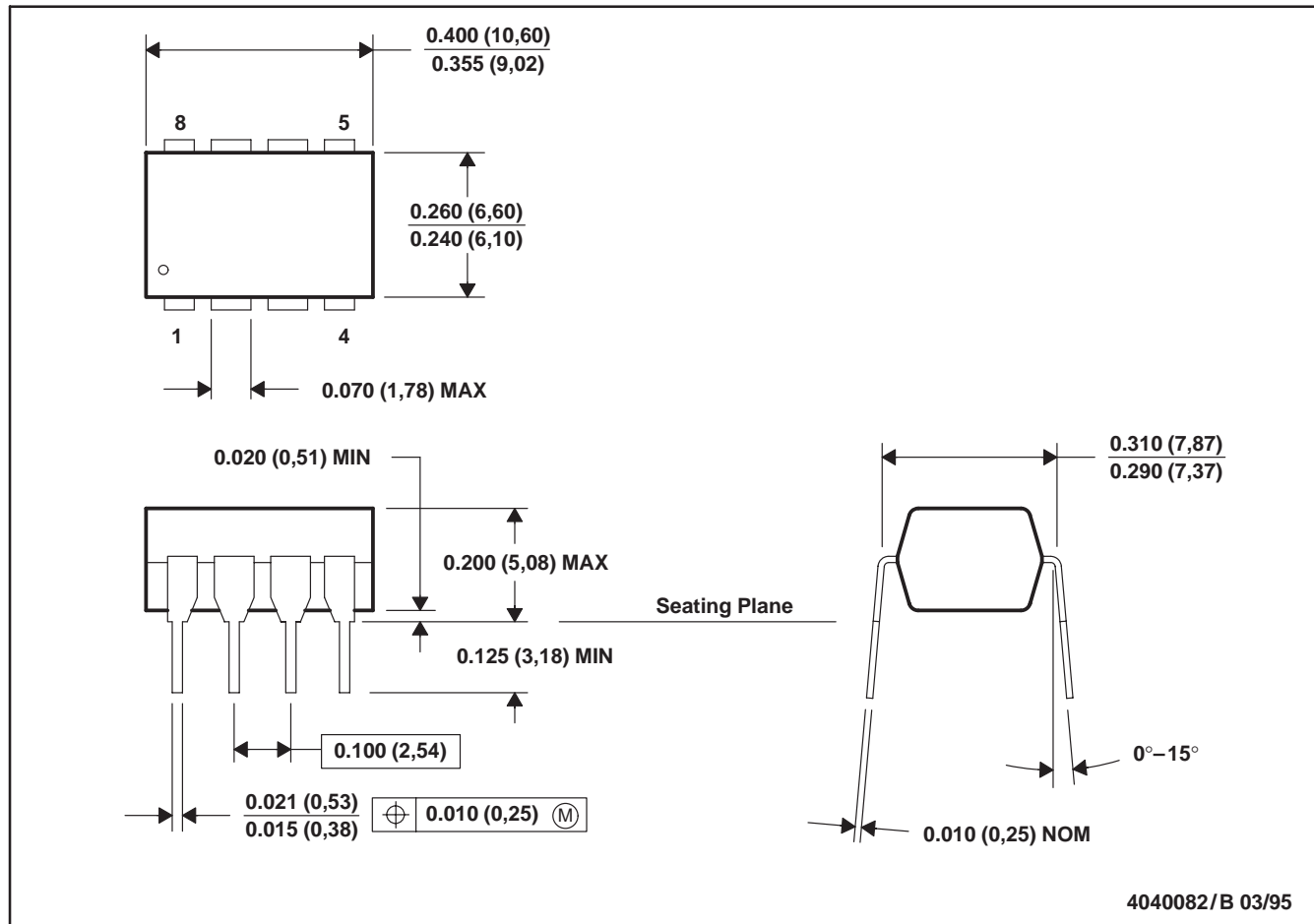

- NOTES: A. All linear dimensions are in inches (millimeters).  
 B. This drawing is subject to change without notice.  
 C. Falls within JEDEC MS-001

## **IMPORTANT NOTICE**

Texas Instruments and its subsidiaries (TI) reserve the right to make changes to their products or to discontinue any product or service without notice, and advise customers to obtain the latest version of relevant information to verify, before placing orders, that information being relied on is current and complete. All products are sold subject to the terms and conditions of sale supplied at the time of order acknowledgment, including those pertaining to warranty, patent infringement, and limitation of liability.

TI warrants performance of its semiconductor products to the specifications applicable at the time of sale in accordance with TI's standard warranty. Testing and other quality control techniques are utilized to the extent TI deems necessary to support this warranty. Specific testing of all parameters of each device is not necessarily performed, except those mandated by government requirements.

Customers are responsible for their applications using TI components.

In order to minimize risks associated with the customer's applications, adequate design and operating safeguards must be provided by the customer to minimize inherent or procedural hazards.

TI assumes no liability for applications assistance or customer product design. TI does not warrant or represent that any license, either express or implied, is granted under any patent right, copyright, mask work right, or other intellectual property right of TI covering or relating to any combination, machine, or process in which such semiconductor products or services might be or are used. TI's publication of information regarding any third party's products or services does not constitute TI's approval, warranty or endorsement thereof.