

## 5-INPUT 3-OUTPUT VIDEO SW

### ■GENERAL DESCRIPTION

The NJM2296 is a 5-input 3-output video switch.  
 Its switches select one from five signals received from VTR, TV, TV GAME and others.  
 This IC is designed for audio items, such as AV amplifier and receivers, and others

### ■PACKAGE OUTLINE



NJM2296D NJM2296M

### ■FEATURES

- 5-input 3-output
- Operating Voltage  $\pm 4.0$  to  $\pm 6.5V$
- Operating Current  $\pm 31mA$  typ. at  $V_{CC}=\pm 5V$
- Crosstalk  $-65dB$  typ.
- Internal 6dB Amplifier
- Internal  $75\Omega$  Driver
- Bipolar Technology
- Package Outline DIP16,DMP16

### ■BLOCK DIAGRAM

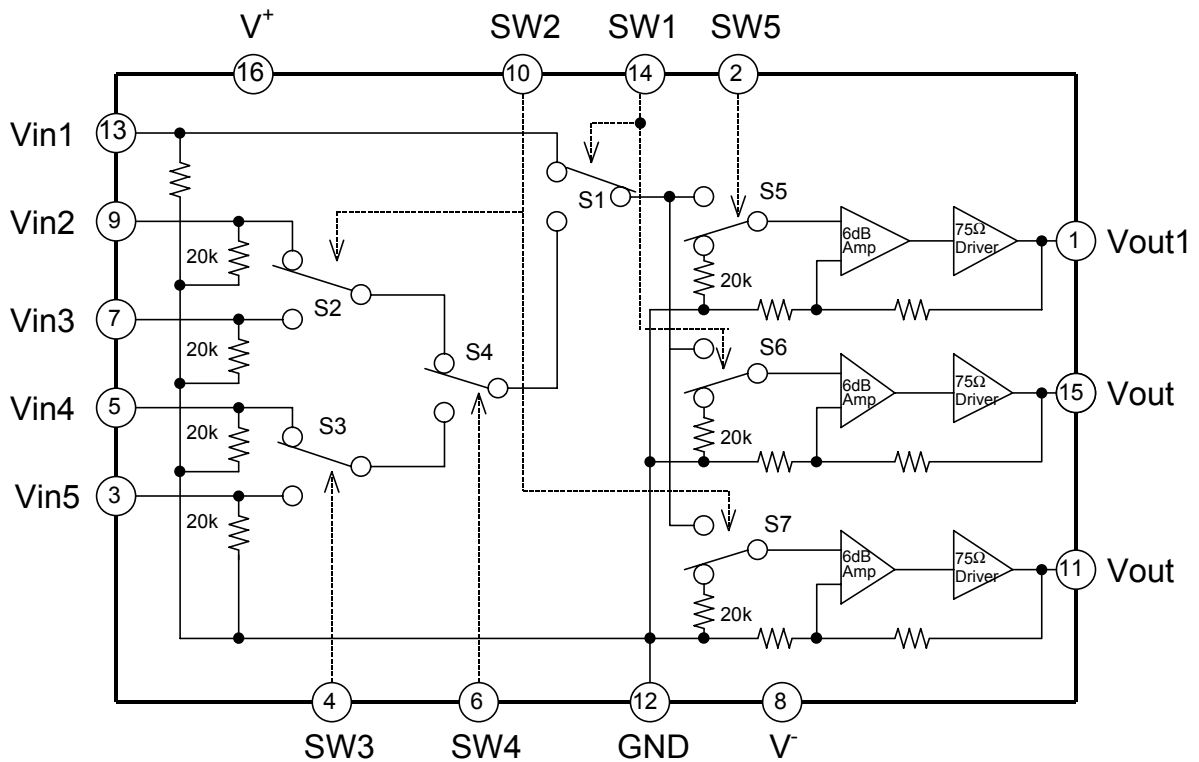

# NJM2296

## ■ABSOLUTE MAXIMUM RATINGS

(Ta=25°C)

PARAMETER	SYMBOL	RATINGS	UNIT
Supply Voltage	$V^+ / V^-$	$\pm 7$	V
Power Dissipation	$P_D$	(DIP16) 700 (DMP) 700*	mW
Operating Temperature Range	Topr	-20 to +75	°C
Storage Temperature Range	Tstg	-40 to +150	°C

\*At on a Glass epoxy board (70x70x1.6mm)

## ■ELECTRICAL CHARACTERISTICS( $V^+ / V^- = \pm 5V, R_L = 150\Omega, Ta = 25^\circ C$ , input sine signal at no condition)

PARAMETER	SYMBOL	TEST CONDITION	MIN.	TYP.	MAX.	UNIT
Positive Operating Current	I <sub>CC</sub>	no signal	-	31.0	-	mA
Negative Operating Current	I <sub>EE</sub>	no signal	-	-31.0	-	mA
Voltage gain	G <sub>v</sub>	V <sub>in</sub> =100kHz/1.0Vpp	6.0	6.3	6.8	dB
Frequency Characteristics	G <sub>f</sub>	5MHz/100kHz, 1.0Vpp	-1.0	0.0	+1.0	dB
Differential Gain	DG	V <sub>in</sub> =1Vpp, Stair Wave	-	0.2	-	%
Differential Phase	DP	V <sub>in</sub> =1Vpp, Stair Wave	-	0.2	-	deg
Output Offset Voltage 1	V <sub>os1</sub>	no signal, V <sub>in2</sub> to V <sub>in3</sub>	-40.0	0.0	+40.0	mV
Output Offset Voltage 2	V <sub>os2</sub>	no signal, V <sub>in1</sub> to V <sub>in2</sub> , V <sub>in1</sub> to V <sub>in3</sub>	-60.0	0.0	+60.0	
Input Crosstalk	CT	V <sub>in</sub> =4.43MHz/1Vpp, V <sub>o</sub> /V <sub>in</sub>	-	-65.0	-	dB
Mute Crosstalk	CT <sub>m</sub>	V <sub>in</sub> =4.43MHz/1Vpp, V <sub>o</sub> /V <sub>in</sub>	-	-55.0	-	dB
Switch Change High Voltage	V <sub>CH</sub>		3.0	-	V <sup>+</sup>	V
Switch Change Low Voltage	V <sub>CL</sub>		0.0	-	1.0	
Total Harmonic Distortion	THD	V <sub>in</sub> =1kHz/1.25Vpp	-	0.1	-	%
Input Impedance	R <sub>in</sub>		-	20.0	-	kΩ

■CONTROL SIGNAL-OUTPUT SIGNAL (L= $V_{CL}$ ,H= $V_{CH}$ ,X=LorH)

SW1	SW2	SW3	SW4	SW5	Vout1	Vout2	Vout3
L	H	X	X	H	Vin1	MUTE	Vin1
	L			Vin1	MUTE	MUTE	
	H			MUTE	MUTE	Vin1	
H	L	X	L	H	Vin2	Vin2	MUTE
				L	MUTE	Vin2	MUTE
H	H	X	L	H	Vin3	Vin3	Vin3
				L	MUTE	Vin3	Vin3
H	H	L	H	H	Vin4	Vin4	Vin4
	L			MUTE	Vin4	Vin4	
	H			Vin4	Vin4	MUTE	
	L			MUTE	Vin4	MUTE	
H	H	H	H	H	Vin5	Vin5	Vin5
	L			MUTE	Vin5	Vin5	
	H			Vin5	Vin5	MUTE	
	L			MUTE	Vin5	MUTE	
L	L	X	X	L	MUTE	MUTE	MUTE

■TEST CIRCUIT

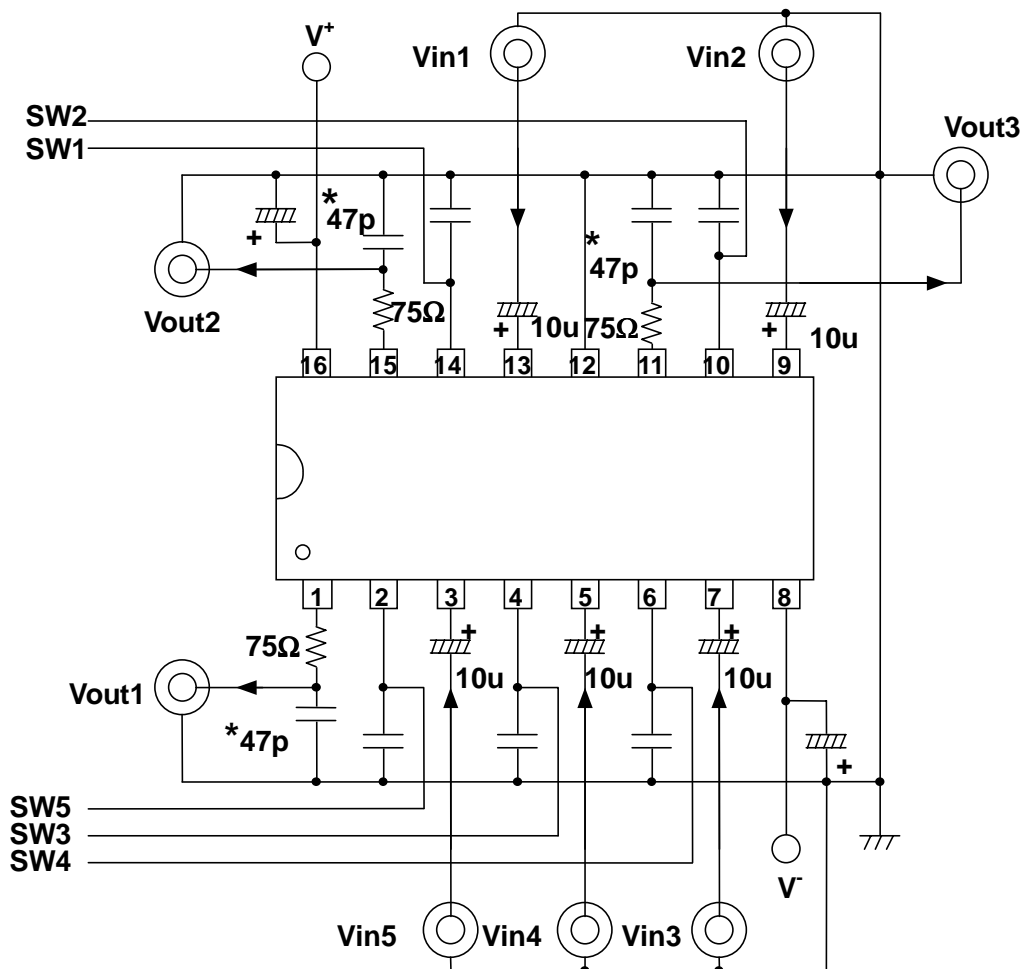

\*NJM2296 designed so that it can drive 150Ω. Connect capacitor for oscillation prevention.

# NJM2296

## ■EQUIVALENT CIRCUIT

PIN NO.	PIN NAME	PIN FUNCTION	INSIDE EQUIVALENT CIRCUIT
3 5 7 9 13	Vin 5 Vin 4 Vin 3 Vin 2 Vin 1	Input Video Signal. This terminal bias to GND on 20kΩ. Signal level is 1Vpp.	
2 4 6	SW 5 SW 3 SW 4	Switch for select signal.	
10 14	SW 2 SW 1	Switch for select signal.	
1 11 15	Vout 1 Vout 3 Vout 2	Output Video Signal. Output signal level is 1Vpp at RL=75Ω.	
16	V+	Positive Supply Voltage	_____
12	GND	GND	_____
8	V-	Negative Supply Voltage	_____

## ■ TYPICAL CHARACTERISTICS

Operating Current vs. Supply Voltage  
( $T_a=25^\circ\text{C}$ )

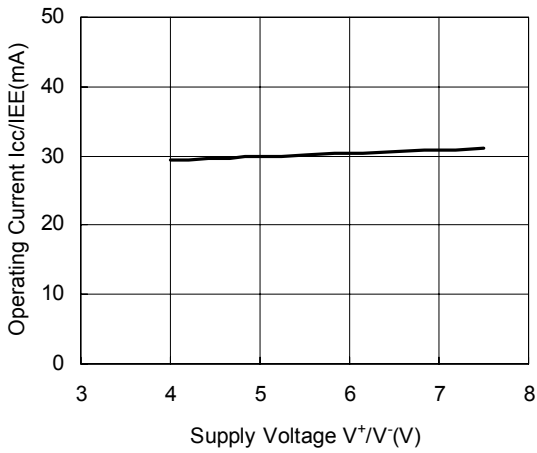

Total Harmonic Distortion vs. Supply Voltage  
( $V_{in}=1\text{kHz}/1.25\text{Vpp}$ ,  $T_a=25^\circ\text{C}$ )

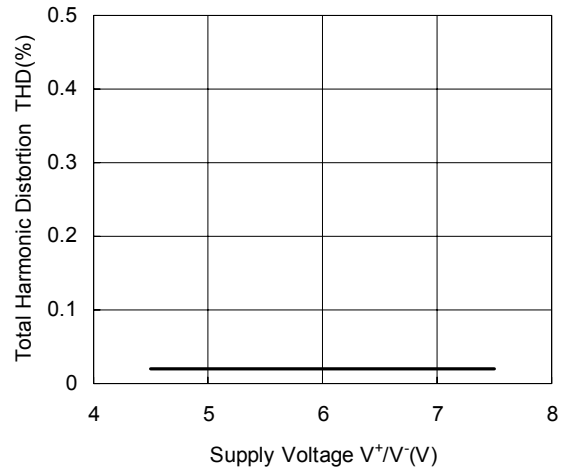

Differential Gain vs. Supply Voltage  
( $T_a=25^\circ\text{C}$ )

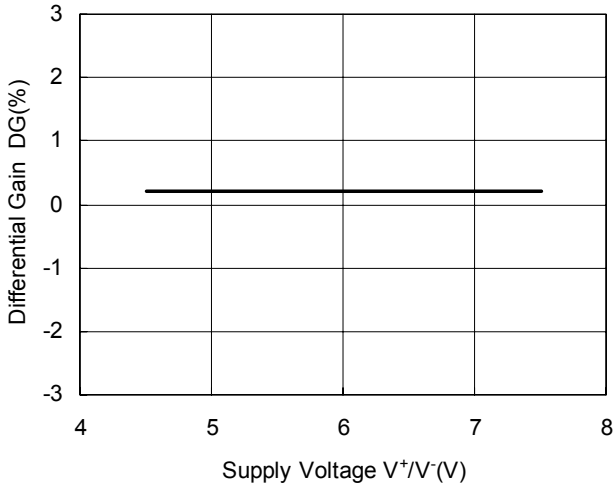

Differential Phase vs. Supply Voltage  
( $T_a=25^\circ\text{C}$ )

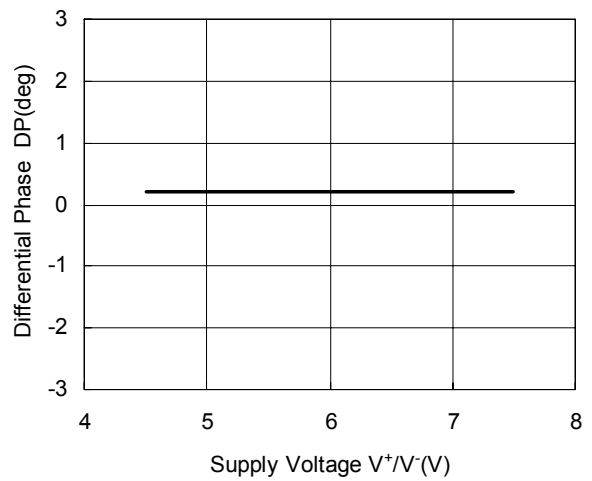

Switching Voltage(High) vs. Supply Voltage  
( $T_a=25^\circ\text{C}$ )

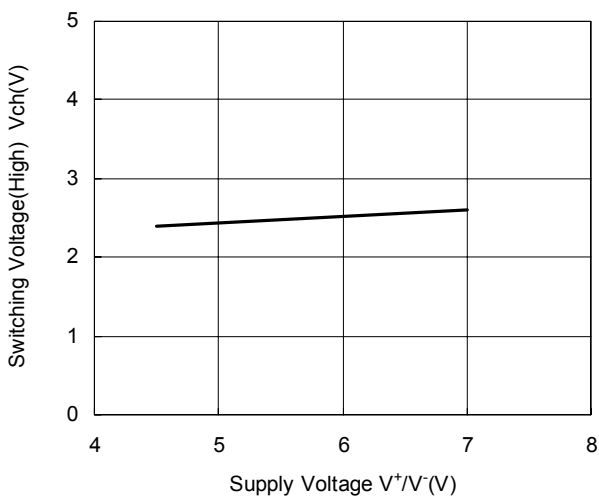

Switching Voltage(Low) vs. Supply Voltage  
( $T_a=25^\circ\text{C}$ )

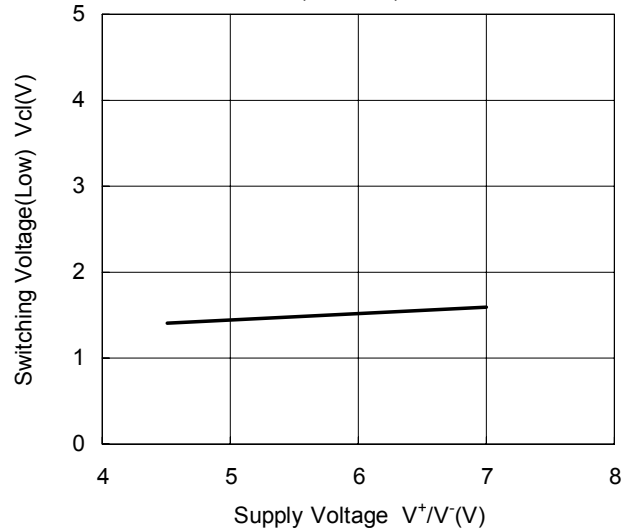

## ■ TYPICAL CHARACTERISTICS

Operating Current vs. Temperature  
( $V^+/V^- = \pm 5V$ )

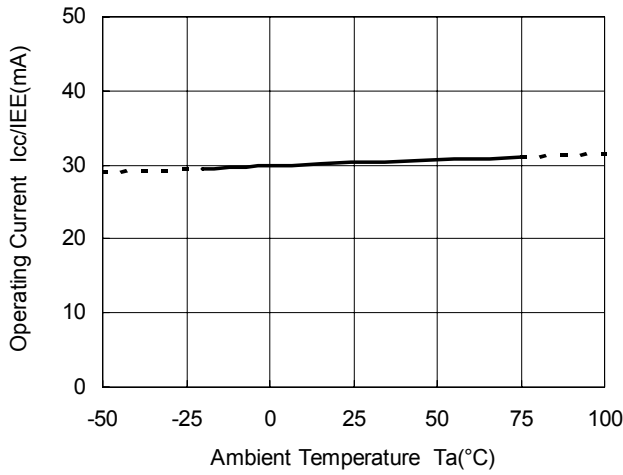

Voltage Gain vs Temperature  
( $V^+/V^- = \pm 5V$ )

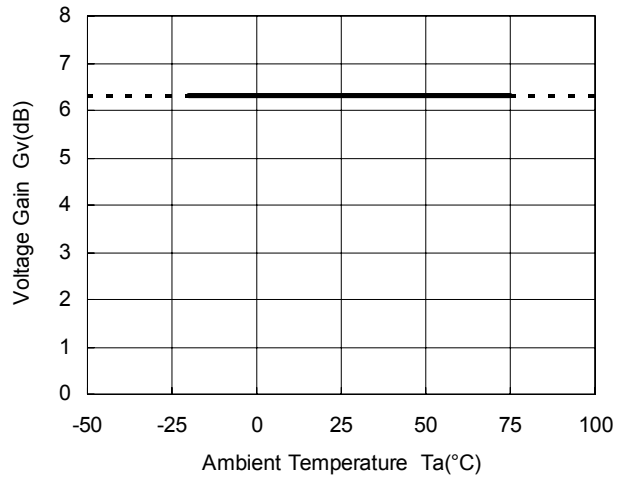

Frequency Characteristic vs. Temperature  
( $V^+/V^- = \pm 5V$ )

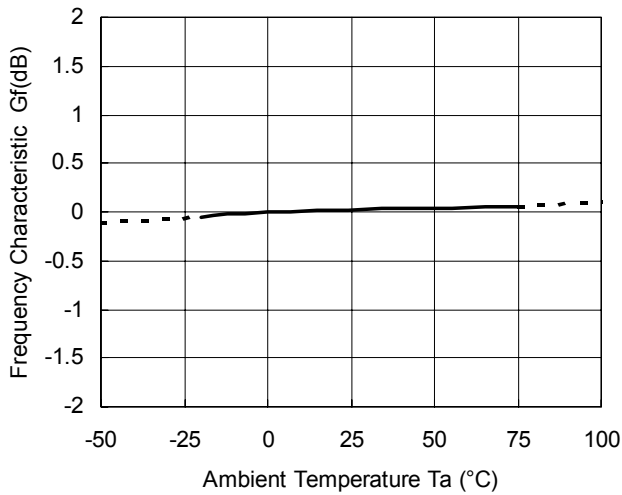

Total Harmonic Distortion vs. Temperature  
( $V^+/V^- = \pm 5V, R_L = 150\Omega, V_{in} = 1kHz/1.25V_{pp}$ )

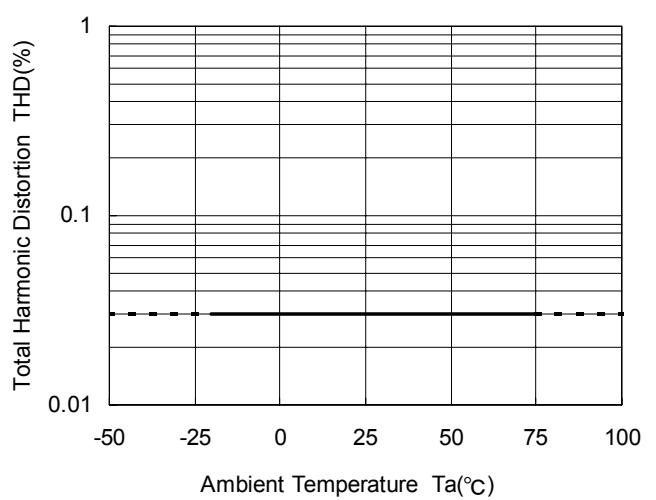

Differential Gain vs. Temperature  
( $V^+/V^- = \pm 5V$ )

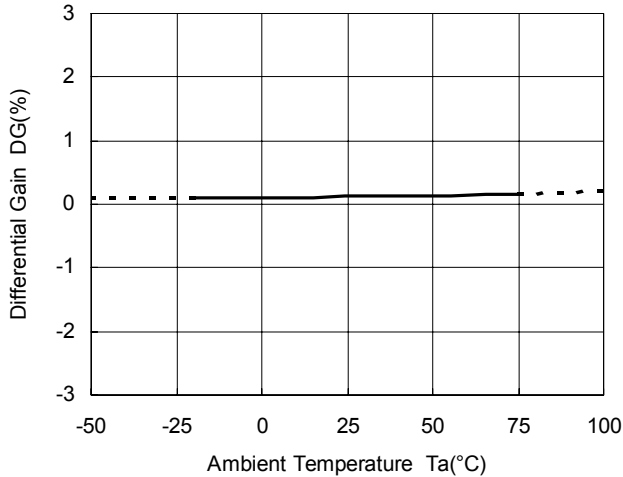

Differential Phase vs. Temperature  
( $V^+/V^- = \pm 5V$ )

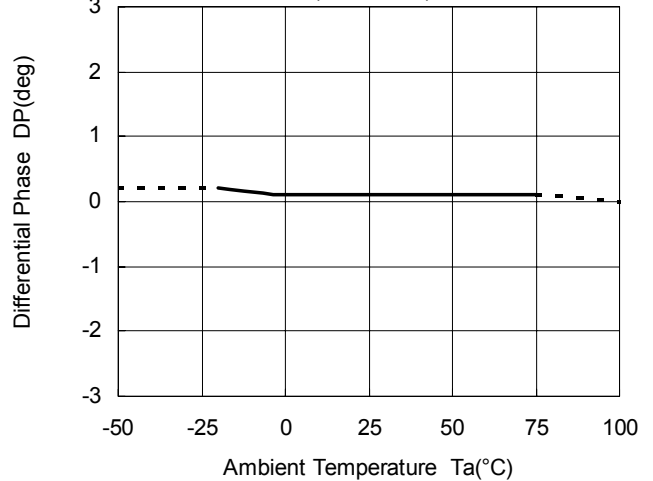

MEMO

[CAUTION]  
The specifications on this databook are only given for information , without any guarantee as regards either mistakes or omissions. The application circuits in this databook are described only to show representative usages of the product and not intended for the guarantee or permission of any right including the industrial rights.