

[查询IR3Y26A供应商](#)

# SHARP

LSIs for LCDs  
AUG. 2002



# LSIs for LCDs

# Meeting the Many Needs of Wide-ranging Applications : SHARP's LSIs for LCDs

The performance of LCD panels has been enhanced by the expansion of LCD use, and improvements are needed in their peripherals.

SHARP contributes to the design of highly functional applications through LSIs for LCDs, such as LCD drivers, LCD controllers, video interface ICs, gray-scale ICs, power supply ICs, etc. that satisfy needs across a wide range of applications.



**STN**  
LCD Drivers



**TFT**  
LCD Drivers

# LSIs for LCDs

## Fundamental Technology of LCD Drivers that Supports LCD Panels

Technology of TFT LCD drivers **TFT**

Technology of STN LCD drivers **STN**

## Fundamental Technology of LCD Drivers

### RSDS™\*1 input **TFT**

contributes to lower EMI\*2 of LCDs, lower power consumption and higher-density mounting.

\*1 RSDS™ : Reduced Swing Differential Signaling  
RSDS is a trademark of National Semiconductor Corporation.

\*2 EMI : Electro-Magnetic Interference

### Partial drive mode **STN**

contributes to low power consumption of LCDs by partially displaying a cellular phone's LCD at standby.

### Twin LCD drive single-chip driver **STN**

can operate as a single-chip LCD driver with fully built-in functions required for LCDs, such as LCD controller, power supply circuit and display RAM.

In addition, to share the use of an LCD driver and a backlight, twin LCDs (main LCD and sub LCD) allow to reduce the size and weight of the products.

### Shadowingless drive **STN**

can create high quality LCDs by suppressing the generation of uneven brightness along with characters and patterns.

### Lower output deviation **TFT**

can suppress uneven output voltage thanks to SHARP's unique off-set cancel function when displaying on the LCDs and by making the brightness of each pixel uniform.

### Dot inversion drive **TFT**

can create high-quality display LCDs by decreasing shadowing and flicker of adjacent dots on the LCDs.

### Dual-edge 1-port input and single-edge 2-port input **TFT**

are made possible decreasing in frequency. At dual-edge 1-port input, the data are sampled at both the rising edge and the falling edge of clocks. At single-edge 2-port input, the data are sampled as 2-pixel data simultaneously at the rising edge or the falling edge of clocks.

## LCD Drivers

## LCD Panels

### Smaller and Thinner Outline

#### High-density mounting

- Several types of TCP and SOF (System On Film)
- COG

#### Twin LCD drive single-chip driver **STN**

### Color Display

Multi level gray scale :  
256-level gray scale  
(16 780 thousand colors) **TFT**  
Multi color : 65 536 colors **STN**

### Lower Power Consumption

#### Low voltage/ Low power consumption

- 1.8 V low voltage drive **TFT**
- Wide variety of power save mode
- Prechargeless output **TFT**
- Partial drive mode **STN**

### Higher Quality

Shadowingless drive **STN**  
Lower output deviation **TFT**  
Dot inversion drive **TFT**

### Lower EMI

#### Decrease in frequency

- Dual-edge 1-port input **TFT**
  - Single-edge 2-port input **TFT**
- #### RSDS™ input **TFT**

### Larger Panel/ Higher Definition

Higher output pin counts :  
480 outputs **TFT**  
Higher speed : 85 MHz **TFT**  
(equivalent to 160 MHz)



# SHARP's LSIs for LCDs Providing a System Solution

SHARP's LSIs for LCDs can provide a system solution in combination with an LCD driver, LCD controller, LCD video interface IC, gray-scale IC and power supply IC, depending on use. SHARP also has contributed to creating smaller sizes and multi-functional products by integrating LCD peripheral LSIs in a stacked package.

★Under development

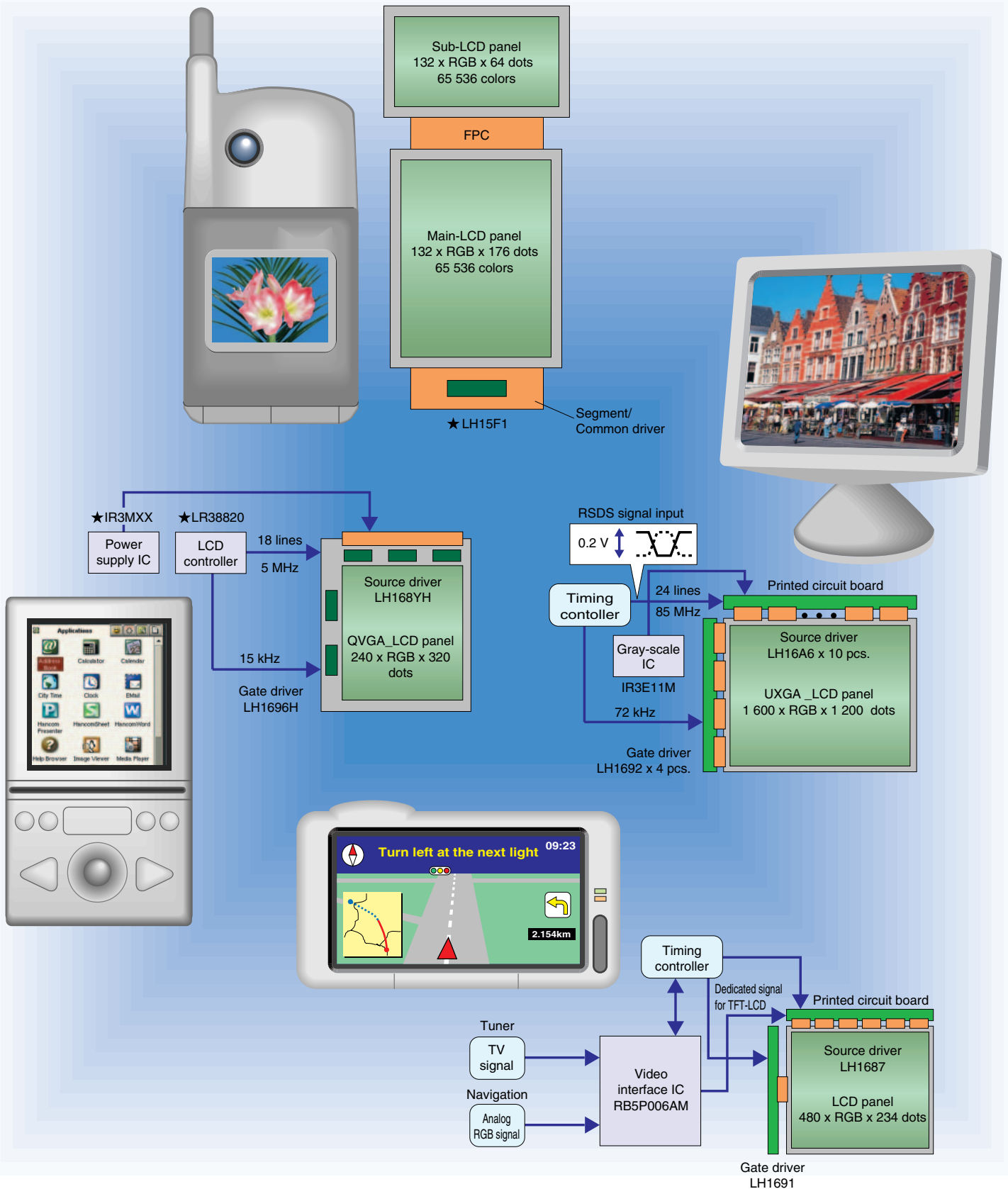

# Lineup of LCD Drivers

★Under development

## ◆ For TFT LCDs

Drive function	Drive technology	Model No.	Gray scale	No. of LCD drive outputs	Display voltage (V)MAX.	Reference page		
Source Drive	Dot Inversion Drive	LH168K	64 levels (6-bit)	309/312/ 321/324	12	4, 7, 8		
		LH168M* <sup>1</sup>		384			13	
		LH168T			13.5			
		LH168S* <sup>2</sup>					402/420	
		★LH16A3* <sup>1</sup>			256 levels (8-bit)			384
		★LH16A4* <sup>1</sup>		15				
		LH168R	480				13	
		★LH16A5* <sup>1</sup>		15				
		LH168V	3, 4, 7, 8					
		★LH16A6* <sup>1</sup>		3, 4, 9, 10				
		Line Inversion Drive	LH168YH		64 levels (6-bit)		240	5.5
			LH168P	300/309	4, 7, 8			
LH16A1	384							
LH1684	Analog		240	4, 9, 10				
LH1687	3, 4, 9, 10							
Gate Drive	—	LH1696H	164	33	3, 4, 9, 10			
		LH1691	240					
		LH1694	256	4, 7, 8				
		LH1692	300	3, 4, 7, 8				

\*1 Low EMI using RSDS™  
EMI : Electro-Magnetic Interference  
RSDS™ : Reduced Swing Differential Signaling. RSDS is a trademark of National Semiconductor Corporation.  
\*2 LH168S is a pin assignment variation of LH168T.

## ◆ For STN LCDs (For Medium/Small Panels)

Type	Drive function	Model No.	No. of LCD drive outputs Segment/Common	Duty ratio	Display voltage (V)MAX.	Supply voltage (V)	Reference page
For Color Graphics (With a built-in display RAM)	Segment and Common	★LH15H1	288/66	1/10, 1/18, 1/26, 1/34, 1/42, 1/50, 1/58, 1/66	+13.2	1.8 to 3.3	4, 5, 6, 12, 13, 14
		LH15A1	384/82	1/17, 1/32, 1/47, 1/62, 1/77, 1/82	+15	1.7 to 3.3	4, 5, 6, 13, 14
		LH15B1* <sup>1</sup>	396/88	to 1/88 (Selectable per 1 line)	+18		
		LH15D1* <sup>1</sup>	396/176	to 1/176 (Selectable per 1 line)	+19	4, 5, 6	
		★LH15E1	396/176 + 64	1.8 to 3.3	3, 4, 5, 6		
		★LH15F1					
For Graphics (With a built-in display RAM)	Segment and Common	LH155K	128/64	1/16, 1/32, 1/48, 1/64	+13.2	1.8 to 3.3	4, 5, 6
		LH155P	134/66	1/10, 1/18, 1/26, 1/34, 1/42, 1/50, 1/58, 1/66			
		LH155R	128/93	1/41, 1/93			
		LH155T	128/109	1/41, 1/109			
		LH155G	248/68	1/67, 1/68	+14	1.8 to 5.5	

\*1 Without display RAM and LCD controller

## ◆ For STN LCDs (For Large/Medium Panels)

Drive technology	Drive function	Model No.	No. of LCD drive outputs	Duty ratio	Display voltage (V)MAX.	Reference page	
New Drive Technology* <sup>1</sup>	Segment (5 V drive)	LH155E* <sup>3</sup>	160	1/100, 1/120, 1/128, 1/200, 1/240, 1/256	+5.5	4, 9, 10	
		LH1583		to 1/240			
		LH1580					
	Common	LH1581	240	to 1/480			
		LH153D	120/160	1/160	+45		
		LH1537	200/240	1/200, 1/240			
LH1538	120/128	to 1/480					
Conventional Drive Technology* <sup>2</sup>	Segment	LH1542	80	to 1/240	+30	4, 9, 10	
		LH1549	160	to 1/480			
		LH1548	240				
	Common	LH1532	100	to 1/240	+30	4, 9, 10	
		LH1530	120	to 1/480			
	Segment or Common	LH1565	160	240	to 1/240	+30	4, 9, 10
		LH1560			to 1/480		
		LH1562					

\*1 New drive technology : A drive technology which drives LCDs with low voltage of 5 V on segment side, and drives LCDs with high voltage on common side. Driving with low voltage on segment side enables LCDs to reduce power consumption and shadowing.

\*2 Conventional drive technology : A drive technology which drives LCDs with high voltage on both segment and common sides.

\*3 With a built-in display RAM

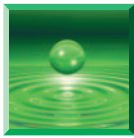

# For Cellular Phones

★Under development



## For Cellular Phones

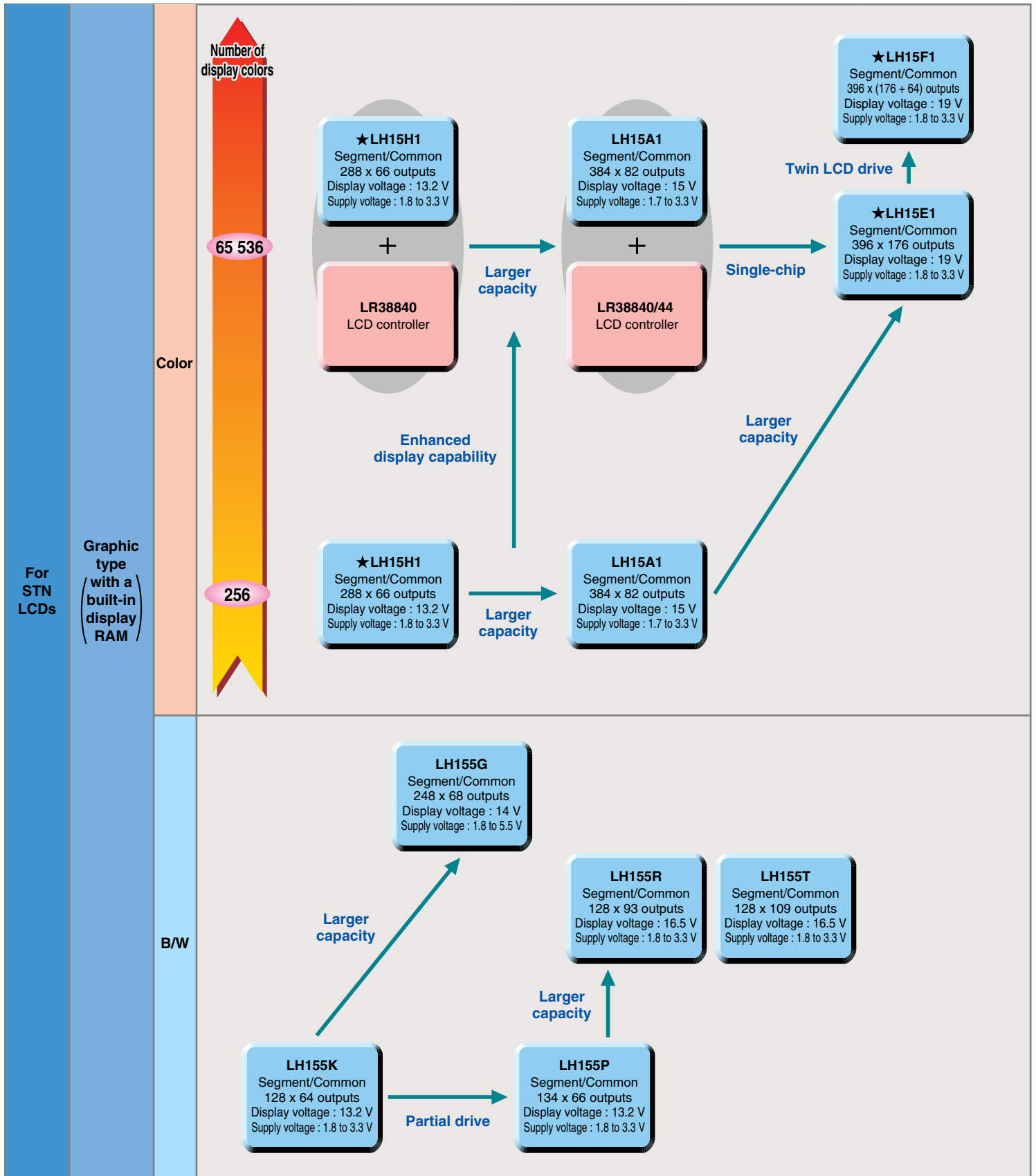

□ : STN-LCD driver

□ : LCD controller



## STN-LCD Drivers for Cellular Phones

Type		Drive function	Model No.	No. of LCD drive outputs		Duty ratio	Display voltage (V) MAX.	Data input	Clock frequency (MHz) MAX.	Supply voltage (V)	Package	
				Segment	Common							
For color graphics (With a built-in display RAM)	256 colors	Segment and Common	★LH15H1	288	66	1/10, 1/18, 1/26, 1/34, 1/42, 1/50, 1/58, 1/66	+13.2	8/16-bit parallel/serial	4 (at 3 V)	1.8 to 3.3	SOF	
			LH15A1	384	82	1/17, 1/32, 1/47, 1/62, 1/77, 1/82	+15					
	65 536 colors		LH15B1*1	396	88	176	to 1/88 (Selectable per 1 line)	+18	[Display data] 12-bit parallel [Command data] Serial	5 (at 3 V)	1.7 to 3.3	TCP/SOF
			LH15D1*1				to 1/176 (Selectable per 1 line)					
			★LH15E1		176 + 64	+19		8/16-bit parallel/serial	4 (at 3 V)	1.8 to 3.3	SOF	
			★LH15F1									
For graphics (With a built-in display RAM)		LH155K	128	64	1/16, 1/32, 1/48, 1/64	+13.2	8-bit parallel/serial	2 (at 3 V)	1.8 to 3.3	TCP		
		LH155P	134	66	1/10, 1/18, 1/26, 1/34, 1/42, 1/50, 1/58, 1/66			3.3 (at 3 V)				
		LH155R	128	93	1/41, 1/93	+16.5		4.5 (at 3 V)				
		LH155T		109	1/41, 1/109							
		LH155G	248	68	1/67, 1/68	+14		3 (at 5 V)	1.8 to 5.5			

\*1 Without display RAM and LCD controller

TCP : Tape Carrier Package SOF : System On Film

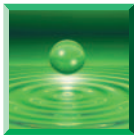

# For Notebook PCs and PC Monitors

★ Under development



## For Notebook PCs and PC Monitors

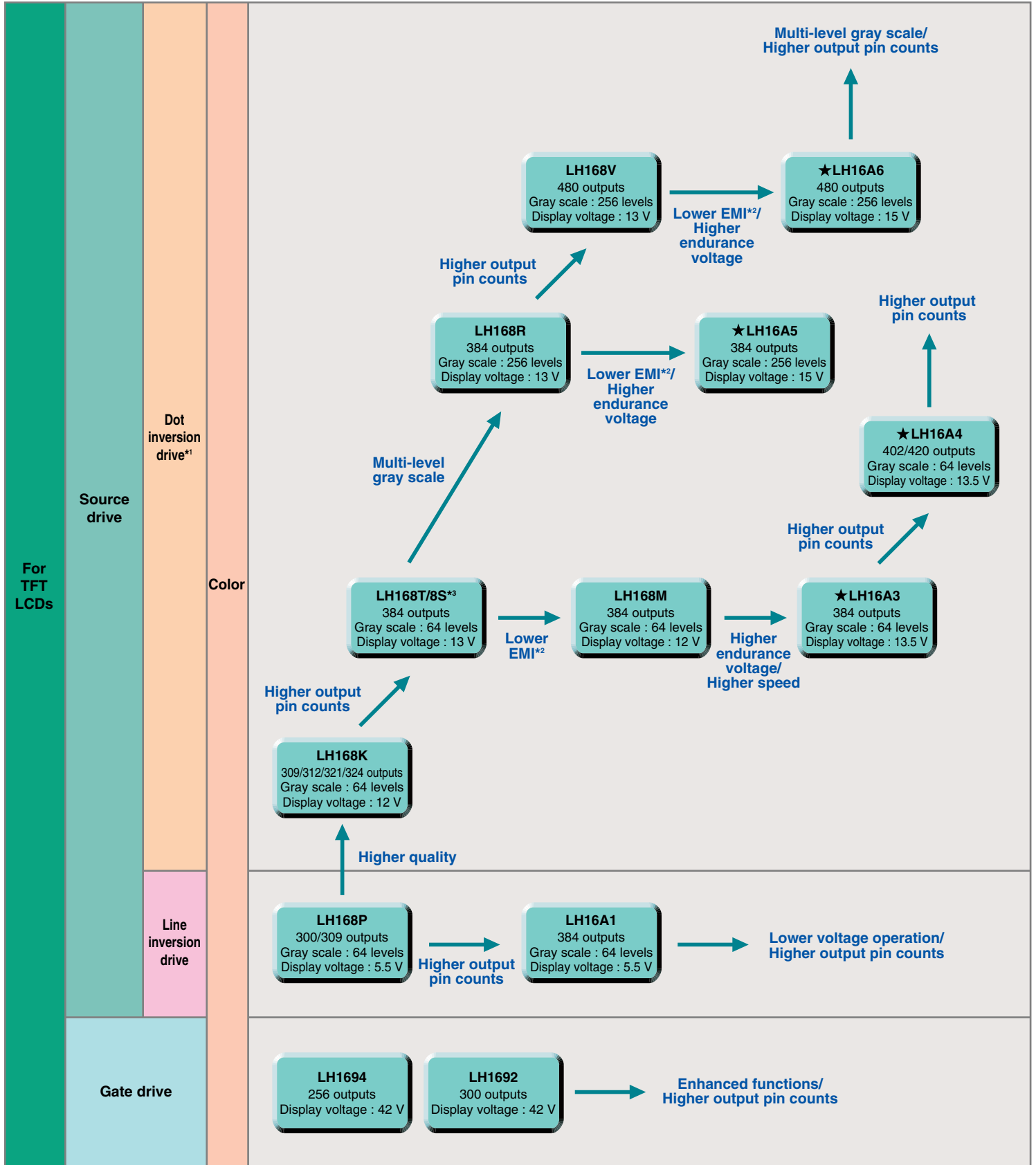

\*1 Low output deviation dot inversion drive  
 \*2 EMI : Electro-Magnetic Interference  
 \*3 LH168S is a pin assignment variation of LH168T.

: TFT-LCD driver





## TFT-LCD Drivers for Notebook PCs and PC Monitors

Drive function	Model No.	Gray scale	No of LCD drive outputs	Display voltage (V) MAX.	Clock frequency (MHz) MAX.	Supply voltage (V)	Function	Package	
Source drive (Dot inversion drive*)	LH168K	64 levels (6-bit)	309/312/ 321/324	12	55	2.7 to 3.6	Data input port selectable : 1 port/2 ports*2, built-in reference voltage generation circuit, R-DAC system	TCP/SOF	
	LH168T			13	65		2-port data input, built-in reference voltage generation circuit, R-DAC system		
	LH168S*3			402/420	12	68	3.0 to 3.6		Low EMI*4 using RSDS*5, built-in reference voltage generation circuit, R-DAC system
	LH168M				13.5	85			
	★LH16A3				2.7 to 3.6	2-port data input, built-in reference voltage generation circuit, R-DAC system			
	★LH16A4	2.5 to 3.6	Low EMI*4 using RSDS*5, built-in reference voltage generation circuit, R-DAC system						
	LH168R			256 levels (8-bit)	480	13	65		Clock single-edge (2-port input) or clock dual-edge (1-port input) selectable (built-in data sampling switching function), built-in reference voltage generation circuit, R-DAC system
	★LH16A5	15	85			Low EMI*4 using RSDS*5, built-in reference voltage generation circuit, R-DAC system			
	LH168V	13	65			2.5 to 3.6	Clock single-edge (2-port input) or clock dual-edge (1-port input) selectable (built-in data sampling switching function), built-in reference voltage generation circuit, R-DAC system		
	★LH16A6	15	85	2.7 to 3.6	Low EMI*4 using RSDS*5, built-in reference voltage generation circuit, R-DAC system				
Source drive (Line inversion drive)	LH168P	64-levels (6-bit)	300/309	5.5	55	3.0 to 5.5	Built-in reference voltage generation circuit, R-DAC system		
	LH16A1		384		57	2.7 to 3.6	2-port data input, built-in reference voltage generation circuit, R-DAC system		
Gate drive	LH1694	—	256	42	0.1	2.7 to 3.6	Output signal masking function, usable with both positive/negative power supplies, enables chain connection		
	LH1692		300			3.0 to 5.5	1-pulse (normal) or 2-pulse (continuous/jumping) scanning selectable, usable with both positive/negative power supplies		

\*1 Low output deviation dot inversion drive

\*2 1-port data input at 309/321 outputs, 2-port data input at 312/324 outputs.

\*3 LH168S is a pin assignment variation of LH168T.

\*4 EMI : Electro-Magnetic Interference

\*5 RSDS™ : Reduced Swing Differential Signaling

RSDS is a trademark of National Semiconductor Corporation.

TCP : Tape Carrier Package SOF : System On Film

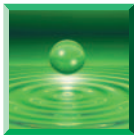

# For Applications with Medium LCD Panels



## For Applications with Medium LCD Panels

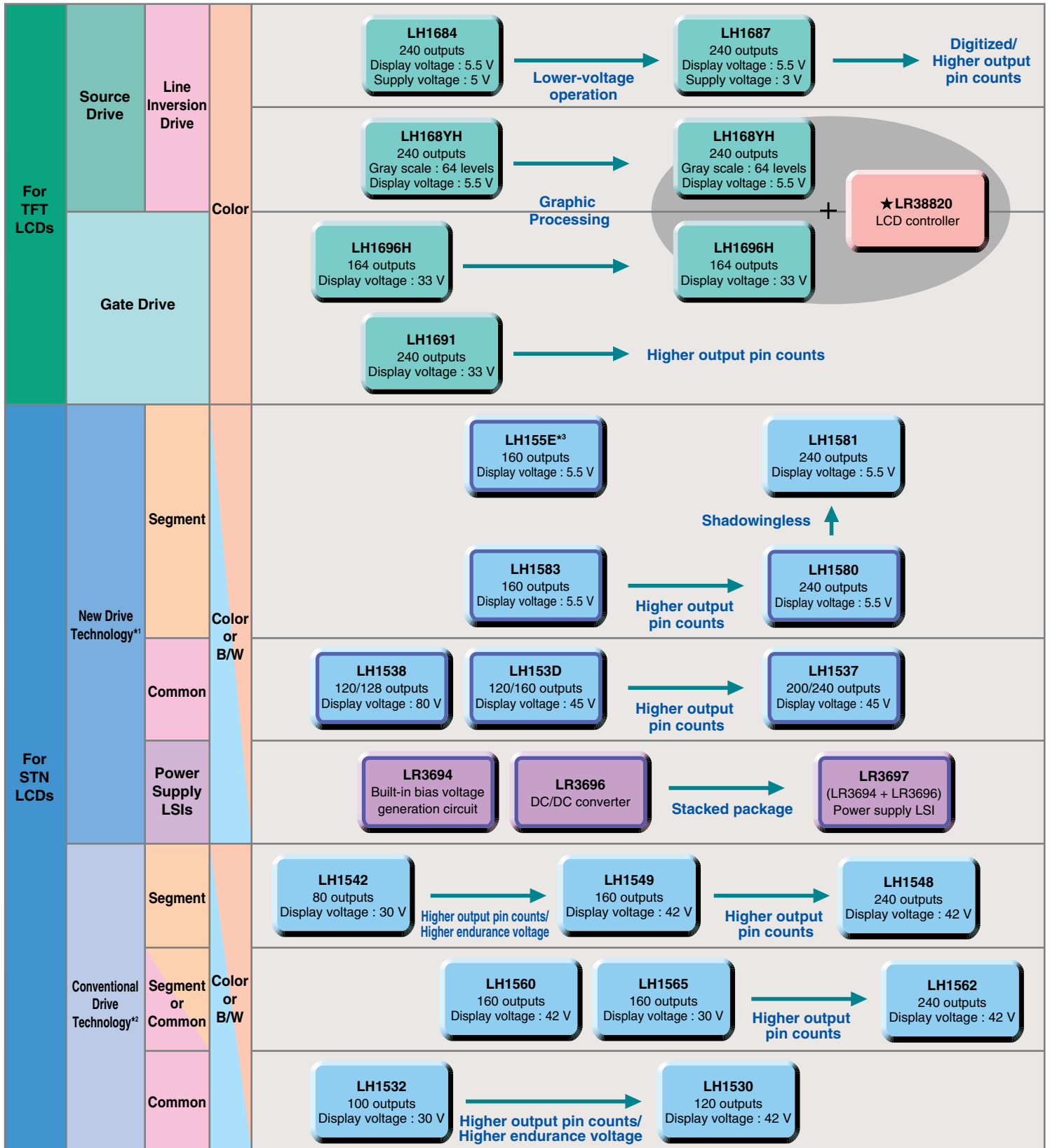

\*1 New drive technology : A drive technology which drives LCDs with low voltage of 5 V on segment side, and drives LCDs with high voltage on common side. Driving with low voltage on segment side enables LCDs to reduce power consumption and shadowing.

\*2 Conventional drive technology : A drive technology which drives LCDs with high voltage on both segment and common sides.

\*3 With a built-in display RAM

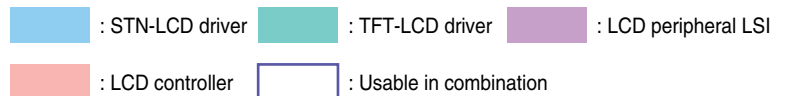

## TFT-LCD Drivers for Applications with Medium LCD Panels

Drive function	Model No.	Gray scale	No of LCD drive outputs	Display voltage (V) MAX.	Clock frequency (MHz) MAX.	Supply voltage (V)	Function	Package	Applications
Source drive (Line inversion drive)	LH168YH	64 levels (6-bit)	240	5.5	35	2.3 to 5.5	Built-in reference voltage generation circuit, R-DAC system, power saving function, polarity inversion of input data	COG	Personal digital assistants
	LH1684	Analog			10	4.5 to 5.5	Three-point simultaneous or normal sampling selectable (Sampling frequency : 20 MHz)	TCP	Automobile navigation systems
	LH1687				12.5	3.0 to 5.5	Three-point simultaneous or normal sampling selectable (Sampling frequency : 25 MHz), power saving function, 3 V drive (MIN.), prechargeless output	TCP/COG	
Gate drive	LH1696H	—	164	33	0.1	2.3 to 5.5	1-pulse scanning, all "Low" mode	COG	Personal digital assistants
	LH1691		240			3.0 to 5.5	1-pulse (normal) or 2-pulse (continuous/jumping) scanning selectable, usable with both positive/negative power supplies	TCP/COG	Automobile navigation systems

TCP : Tape Carrier Package COG : Chip On Glass

## STN-LCD Drivers for Applications with Medium LCD Panels

Drive technology	Drive function	Model No.	No. of LCD drive outputs	Duty ratio	Display voltage (V) MAX.	Data input	Clock frequency (MHz) MAX.	Supply voltage (V)	Package	Applications
New drive technology*1	Segment	LH155E*3	160	1/100, 1/120, 1/128, 1/200, 1/240, 1/256	+ 5.5	8-bit parallel/serial	2 (at 3 V)	2.4 to 3.3	TCP	Personal digital assistants
		LH1583		to 1/240		4/8-bit parallel	12 (at 2.4 V)/ 20 (at 5 V)	2.4 to 5.5		
		LH1580	240	to 1/480		8/12-bit parallel	30 (at 2.5 V)/ 55 (at 5 V)	2.5 to 5.5		
		LH1581		to 1/480		3 (at 2.4 V)/ 4 (at 5 V)	2.4 to 5.5			
	Common	LH153D	120/160	1/160	+ 45	—	3 (at 2.4 V)/ 4 (at 5 V)	2.4 to 5.5		
		LH1537	200/240	1/200, 1/240	+ 80	—	3 (at 2.5 V)/ 4 (at 5 V)	2.5 to 5.5		
Conventional drive technology*2	Segment	LH1542	80	to 1/240	+ 30	4-bit parallel	8	2.5 to 5.5		
		LH1549	160	to 1/480	+ 42	4/8-bit parallel	12 (at 2.5 V)/ 20 (at 5 V)			
		LH1548	240			8/12-bit parallel	12 (at 2.5 V)/ 25 (at 5 V)			
	Common	LH1532	100	to 1/240	+ 30	—	4			
		LH1530	120	to 1/480	+ 42	—	3 (at 2.5 V)/ 4 (at 5 V)			
	Segment or Common	LH1565	160	to 1/240	+ 30	4/8-bit parallel (at segment drive)	[Segment mode] 8 [Common mode] 4			
LH1560		to 1/480		+ 42	8 (at 2.5 V)/14 (at 5 V) [Common mode] 4					
LH1562	240				12 (at 2.5 V)/20 (at 5 V) [Common mode] 4					

\*1 New drive technology : A drive technology which drives LCDs with low voltage of 5 V on segment side, and drives LCDs with high voltage on common side. Driving with low voltage on segment side enables LCDs to reduce power consumption and shadowing.

\*2 Conventional drive technology : A drive technology which drives LCDs with high voltage on both segment and common sides.

\*3 With a built-in display RAM

TCP : Tape Carrier Package

## Power Supply LSIs for Medium STN-LCD Panels

Model No.	Description	Supply voltage (V)	Package
LR3694	Bias voltage generation circuit for LCD drive, electronic volume control circuit	2.4 to 3.3 (V <sub>DD</sub> , V <sub>P</sub> ), 14.4 to 19.8 (V <sub>HE</sub> ), -16.5 to -12.0 (V <sub>LS</sub> )	P-TQFP048-0707
LR3696	DC/DC converter for LCD drive power supply		P-QFP032-0707
LR3697	DC/DC converter for LCD drive power supply, bias voltage generation circuit for LCD drive, electronic volume control circuit		P-QFP072-1010

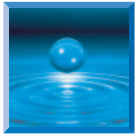

# Package Technologies for LCD Drivers

Improvements in SHARP's original packaging technology, as well as in design and wafer process technologies, make possible smaller, thinner and more highly-functional LCD drivers. SHARP can provide two types of packages, TCP and SOF, which can be selected depending on customer needs.

## — TCP (Tape Carrier Package) —

This is a package which can easily achieve higher pin counts, finer pin pitches and reduced dimensions. It allows flexible pattern design of outer lead shapes and pitches, to accept different pin connections. Depending on use, SHARP's TCPs are available in a variety of tape patterns, coatings, and other options. We can customize our TCPs to accommodate our customers' needs.

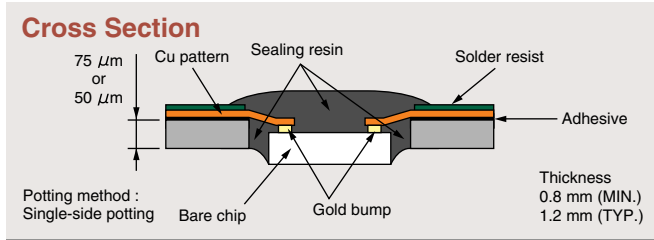

### Features

- Both face-up or face-down chip mounting are available.
- Alignment can be easily determined on user side by adopting overhang pattern.
- Capable of incorporating passive components.

### TCP Varieties

#### UST (Ultra-Slim TCP)

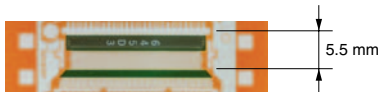

The UST combines ultra-slim chip technology and TCP technology to achieve an external TCP size of 5.5 mm.

#### High-Pin-Count Fine-Pitch TCP

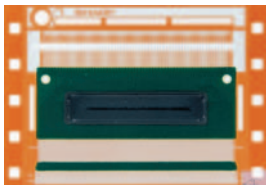

Using fine-pitch technology, a 35 mm-wide tape, 480-output (pad pitch 50 μm; outer lead pitch 55 μm), high-pin-count and fine-pitch TCP has been developed.

#### Super Soft Flexible TCP

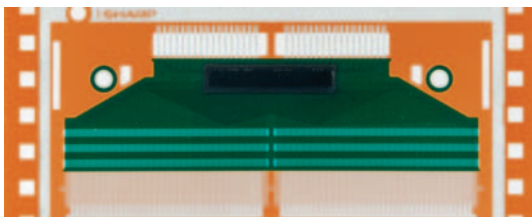

The enhancement of our own TCP assembly technology and tape materials has resulted in the development of a super-soft flexible TCP, a product that has improved bendability and three times as much bending strength as existing products.

## — SOF(System On Film) —

This package enables mounting of various components including bare chips, such as LCD drivers and LCD controllers, and peripheral circuit components onto film. It contributes to the realization of higher-level functions in applications. This package is mainly used in small LCD panels and contributes to making smaller and thinner portable equipment.

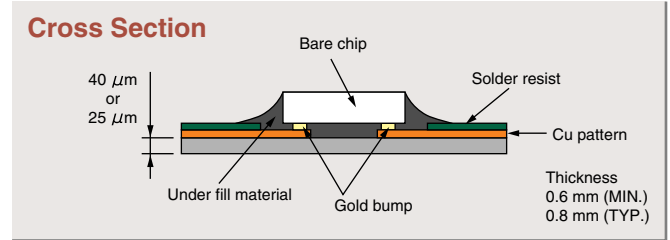

### Features

- Capable of mounting various components including bare chips, such as LCD drivers and LCD controllers, and peripheral circuit components.
- Contributes to the design of thin and compact products thanks to highly flexible and thin film package which can be bent freely, such as by angle-bending.
- Suitable for finer pin pitches due to absence of flying lead.
- Flexible pattern design can be achieved by designing patterns on a film under the chip.

#### Single chip SOF

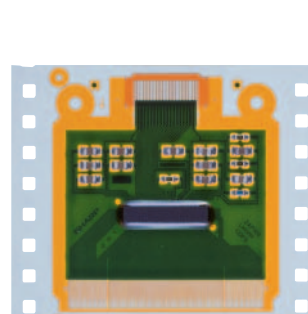

#### Multi chip SOF

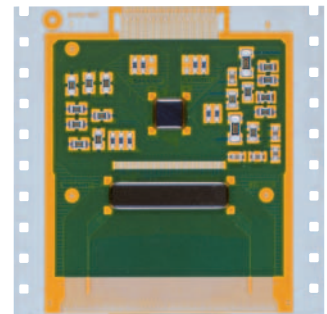

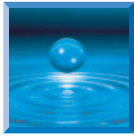

# SOF Modules

★Under development

SHARP offers SOF (System On Film) modules with LCD drivers mounted on film. As multiple chip mounting is possible, they enable mounting of various components including bare chips, such as LCD drivers and LCD controllers, LCD panels, and peripheral circuit components. Therefore, they can help create system modules for a range of applications, and make possible higher-level functions in applications. We can provide a standard product, LR0G918A, suitable for sub LCD display of a cellular phone, a toy camera, etc.

## Features

### ●Multiple chip mounting

Enables mounting of various components including bare chips, such as LCD drivers and LCD controllers, LCD panels, and peripheral circuit components, and thereby contributes to the realization of higher-level functions in applications.

### ●Fully custom-designed package

### ●Highly flexible and thin film package

By using highly flexible and thin film, SOF modules contribute to the design of thin and compact products. They can also easily achieve finer pin pitches and higher output pin counts.

## LCD Module

Model No.	★LR0G918A
Module structure	<ul style="list-style-type: none"> <li>• LCD panel + SOF (with an LCD driver)</li> <li>• Built-in LCD drive power supply circuit and oscillator</li> </ul>
LCD panel	Color STN, transfective
Dot format H x V (dot)	72 x RGB x 64
Active area W x H (mm)	17.268 x 15.345
Dot size W x H (mm)	0.068 x 0.24
LCD driver	★LH15H1
Duty ratio	1/10, 1/18, 1/26, 1/34, 1/42, 1/50, 1/58, 1/66
LCD drive power supply	Built-in booster circuit (x 2, x 3, x 4)
Outline dimensions W x H x D (mm)	25 x 44.34 x approx. 1.47*1
MPU Interface	8/16-bit parallel (68-family/80-family)
Supply voltage (V)	$V_{DD} = V_{EE} = 3.0$ (recommended)
Operating temp. (°C)	-20 to +70
Storage temp. (°C)	-30 to +80

\*1 W : Not including the burr of plastic mold resin. H : Indicates the size before SOF bending.  
D : Indicates the thickness of LCD panel.  
Module without LCD panel is also available.

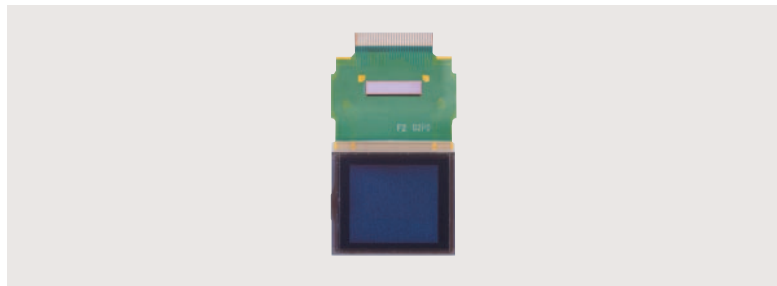

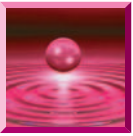

# Road Map for LCD Controllers

★ Under development

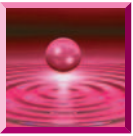
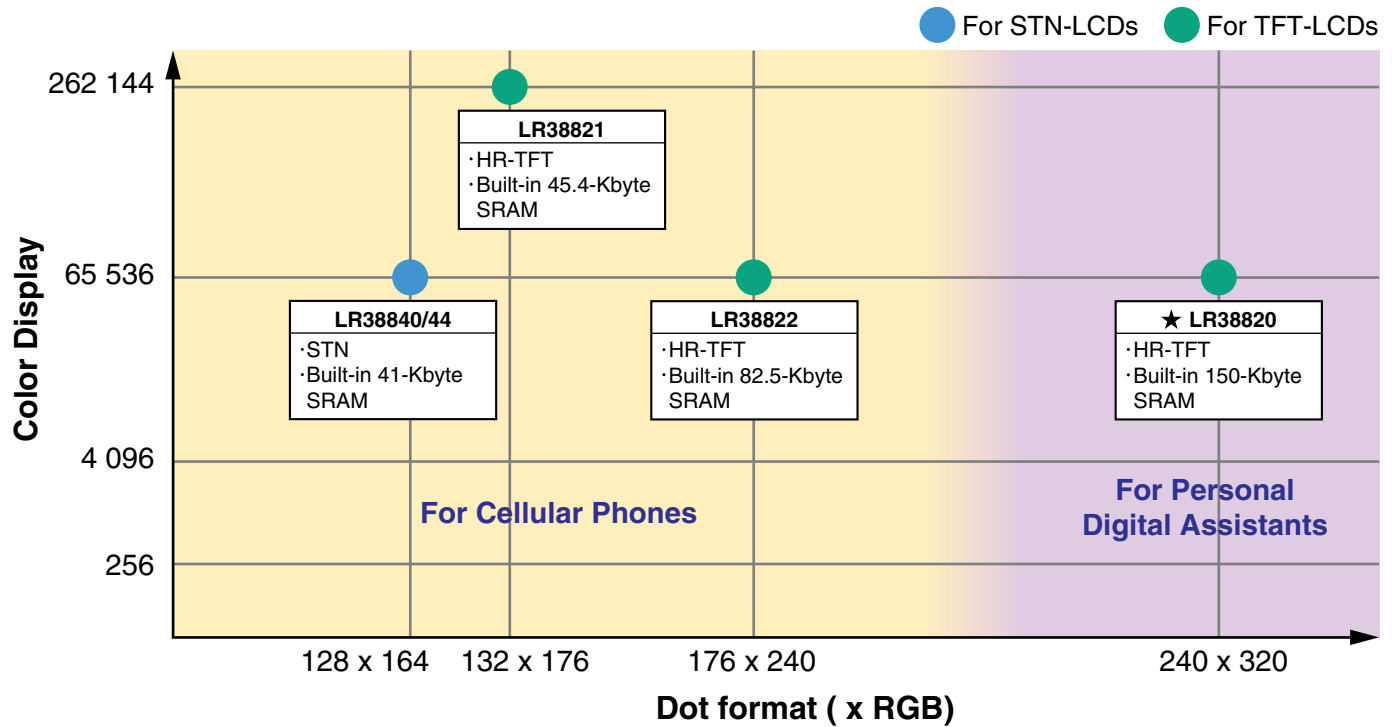

# Features of LCD Controllers

★ Under development



## STN-LCD Controllers for Cellular Phones (LR38840/LR38844)

- Provides 65 536-color display
- Display color selectable : 256/4 096/ 65 536 colors
- Low power consumption
- CPU interface : 68-family or 80-family selectable
- Bus width : 8-bit or 16-bit selectable
- For LH15A1 or ★LH15H1 (LR38840)  
For LH15A1 (LR38844)
- LCD size : up to 20 992 (128 x 164) dots

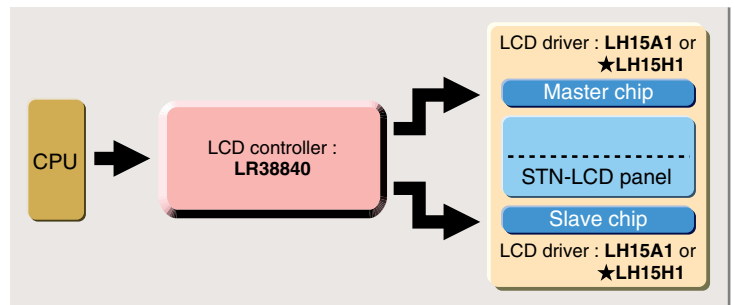

## TFT-LCD Controllers for Cellular Phones (LR38821/LR38822)

- Provides 262 144-color display (LR38821)  
Provides 65 536-color display (LR38822)
- Low power consumption
- CPU interface : 80-family (LR38821)  
68-family and 80-family selectable (LR38822)
- Bus width : 8-bit or 16-bit selectable
- LCD size : up to 23 232 (132 x 176) dots (LR38821)  
up to 42 240 (176 x 240) dots (LR38822)



## TFT-LCD Controller for Personal Digital Assistants (★LR38820)

- Built-in simple graphic processing functions, such as copying, mirror imaging, painting out and rotation, which places a minimal load on the main CPU.
- Provides 65 536-color display
- Low power consumption
- CPU interface : 80-family
- Bus width : 16-bit
- LCD size : up to 76 800 (240 x 320) dots

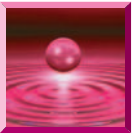

# LCD Controller Evaluation Tools

SHARP can provide whole-system evaluation boards that work through linkage to user systems.

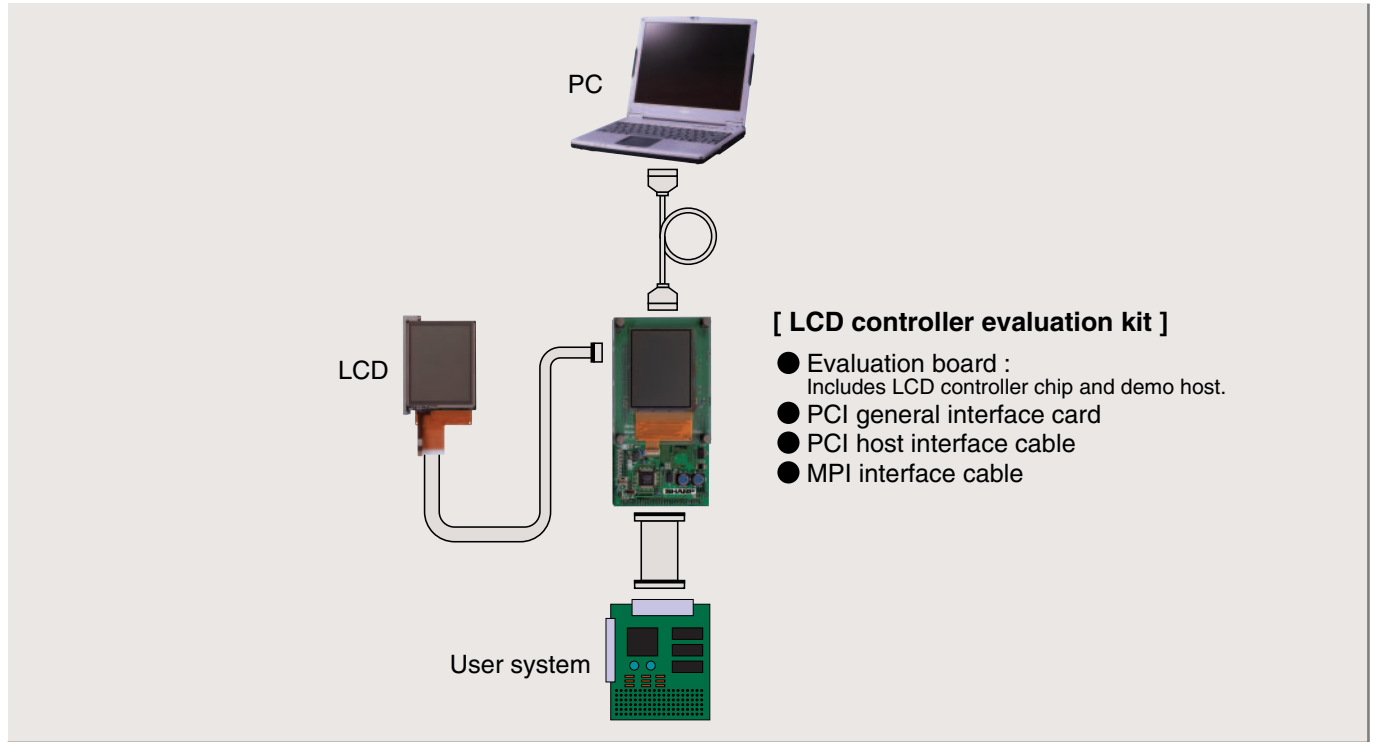

For further details, contact a SHARP sales office.



# Specifications for LCD Controllers

★ Under development



## STN-LCD Controllers for Cellular Phones

Model No.	Display area (Dot) MAX.	Display color [MAX.]	Function/Feature	CPU interface	Frame memory size	Supply voltage (V) TYP.	Power consumption*1 (mW) TYP.	Package		
							256-color display   65 536-color display			
LR38840	128 x RGB x 164	65 536	<ul style="list-style-type: none"> <li>• Provides 65 536-color display</li> <li>• Display colors selectable : 256/4 096/65 536 colors</li> <li>• Power saving function, reducing the power consumption in standby mode</li> <li>• Built-in CPU interface, LCD interface, clock generator, display memory</li> </ul>	For LH15A1, ★LH15H1	68-family/80-family (8/16-bit)	41 Kbytes	2.5	1.5	7	T-TFBGA081-0808
LR38844			<ul style="list-style-type: none"> <li>• High-speed host access</li> <li>• Higher performance model</li> <li>• Provides 65 536-color display</li> <li>• Display colors selectable : 256/4 096/65 536 colors</li> <li>• Power saving function, reducing the power consumption in standby mode</li> <li>• Built-in CPU interface, LCD interface, clock generator, display memory</li> </ul>	For LH15A1					6	

\*1 When connected to 8-bit bus at 5.4 MHz.



## TFT-LCD Controllers for Cellular Phones

Model No.	Display area (Dot) MAX.	Display color [MAX.]	Function	CPU interface	Frame memory size	Supply voltage (V) TYP.		Power consumption (mW) TYP.	Package
						Core	I/O		
LR38821	132 x RGB x 176	262 144	<ul style="list-style-type: none"> <li>• Built-in CPU interface, LCD interface, timing generator, clock generator, display memory</li> </ul>	80-family (8/16-bit)	45.4 Kbytes	2.5	3.3	3	T-TFBGA112-1010
LR38822	176 x RGB x 240	65 536		68-family/80-family (8/16-bit)	82.5 Kbytes			5	



## TFT-LCD Controller for Personal Digital Assistants

Model No.	Display area (Dot) MAX.	Display color [MAX.]	Function	CPU interface	Frame memory size	Supply voltage (V) TYP.		Power consumption (mW) TYP.	Package
						Core	I/O		
★LR38820	240 x RGB x 320	65 536	<ul style="list-style-type: none"> <li>• Simple graphic processing function*1</li> <li>• Built-in CPU interface, LCD interface, timing generator, clock generator, display memory</li> </ul>	80-family (16-bit)	150 Kbytes	2.5	3.3	25	P-LQFP120-1414/ T-TFBGA112-1010

\*1 It enables simple graphic processing, such as copying, mirror imaging, painting out and rotation, which places a minimal load on the main CPU.

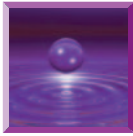

## Gray-scale ICs for TFT-LCDs

Model No.	Panel type	Function	No. of output circuits	Output current (mA) MAX.	Common output current (mA) MAX.	Supply voltage (V) TYP.	Package
IR3E201N/ IR3E204N	·Small panels ·Line inversion drive	Gray-scale voltage generator for LCD drivers, built-in dividing resistors	10	±1	±1	5	P-MFP018
IR3E3XX			5	±1	±1	5	P-SSOP012-0225
IR3E08M1	·Medium/Large panels ·Line inversion drive	Gray-scale voltage generator for LCD drivers	9	±10	±10	5	P-TQFP048-0707
IR3E11M			10	±15	±150	10.5	
★IR3E12M			18	±15	±150	10.5	

## Features

### ● For small TFT-LCD panels : IR3E2 series and IR3E3 series

- Ideal for mobile equipment thanks to low-power-consumption design.
- Integrating regulator and resistance array dramatically reduces the number of external components.
- The setting of output voltage can be customized, depending on the LCD characteristics.

### ● For large TFT-LCD panels with dot inversion drive : IR3E11M and ★IR3E12M

- Available for up to 20-type SXGA or UXGA panels with large common output current (±150 mA [MAX.]).
- External volume and gray-scale adjustment are not required by integrated high-definition regulator.
- The number of LCD components can be decreased.

## System Configuration Example : Small TFT-LCDs (IR3E2 series and IR3E3 series)

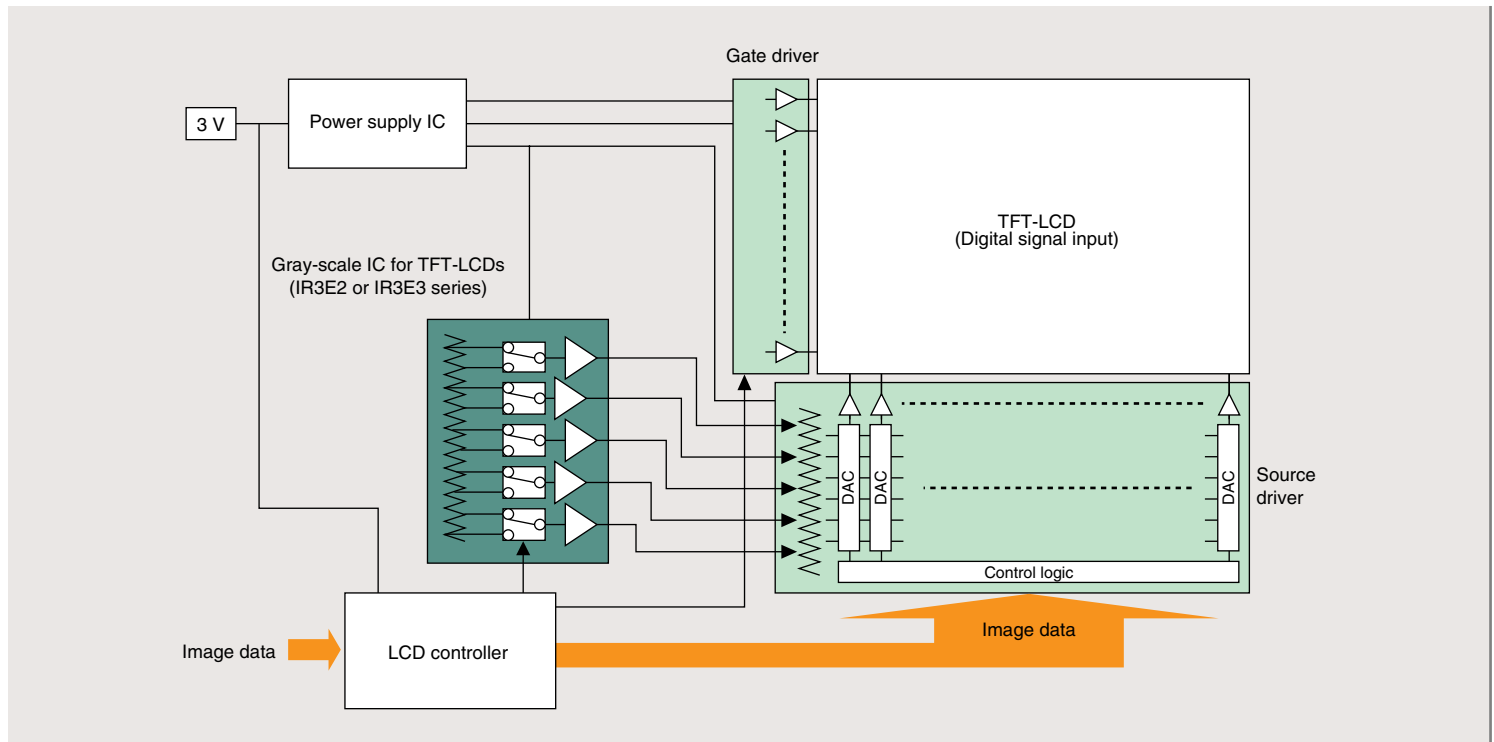

## Power Supply IC for TFT-LCDs

Model No.	Supply voltage(V)	Output voltage (V)TYP.			Load current (mA)			Package
		V <sub>DD</sub>	V <sub>OUT1</sub>	V <sub>OUT2</sub>	V <sub>DD</sub>	V <sub>OUT1</sub>	V <sub>OUT2</sub>	
★IR3MXX	2.7 to 3.6	5.1	15.3	-10.2	0 to -10	0 to -0.2	0 to 0.2	P-VQFN020-0404



## Video Interface ICs for TFT-LCDs

Model No.	Input signal				Color decode	LCD panel				Serial data control	Supply voltage (V)	Power consumption (mW) TYP.	Package
	Composite video	Y/C	Y/color difference	Analog RGB		±power source	+power source	Low voltage source	Digital input				
IR3Y18A		○			NTSC/PAL	○	○				4.5/12 or 4.5/-7.5	130	P-QFP048-0707
IR3Y26A/A1				○	-			○			5/7.5	140	P-QFP048-1010/ P-QFP048-0707
IR3Y29AM/BM	○	○		○	NTSC/PAL			○				190	P-QFP048-0707
IR3Y31M	○	○		○	NTSC/PAL	○	○			4.5/12 or 4.5/-7.5		160	
IR3Y34M			○	○	-		○			3/12		88	
IR3Y35M			○	○	-		○					91	
IR3Y37M			○	○	-			○				95/77*2	
IR3Y37AM			○	○	-			○		3/6.5		106/88*2	
RB5P0010M				○	-	○	○		○	3/12 or 3/4.5/-7.5		92	
RB5P0020M			○	○	-			○		3/5		70/57*2	
RB5P0050M			○	○	-			○				95/80*2	
RB5P0060M		○		○	NTSC/PAL			○	○	3/5/13		120	
RB5P006AM	○	○		○	NTSC/PAL			○	○				
★RB5P0070M*1	○	○		○	NTSC/PAL				○	3/7		330	P-QFP072-1010

○ : Available

\*1 For digital signal input panels

\*2 At analog RGB input

## Features

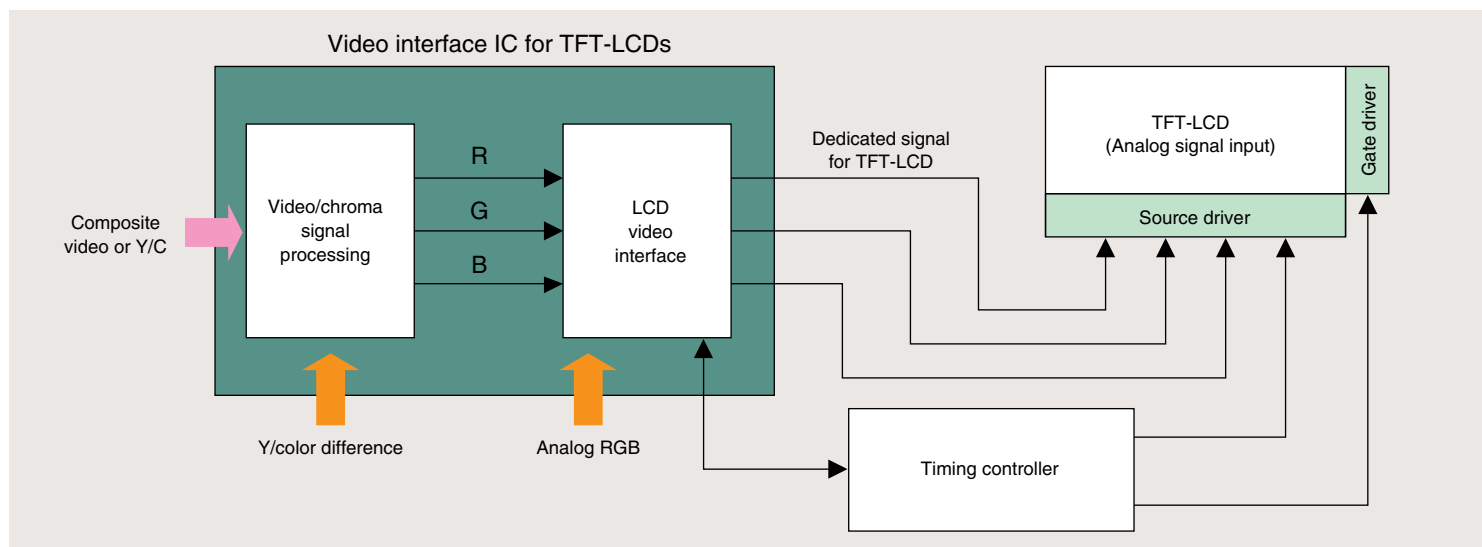

- Suitable for battery driven products thanks to low power consumption.
- Wide lineup variety, from amorphous silicon TFT-LCDs to poly-silicon TFT-LCDs.
- Natural gray-scale display and wide range of brightness adjustment are realized by adopting original SHARP brightness adjustment circuit where common amplitude and gamma correction point react to each other.
- Can be unified with a timing controller IC by adopting a stacked package and can adopt QFN packages to contribute to making smaller products.

## System Configuration Example : Analog Signal Input TFT-LCDs





## Classification of Video Interface ICs for TFT-LCDs

Applications		 Compact LCD TVs/ Automobile navigation systems	 Digital still cameras/Camcorders/ Automobile navigation systems	 Digital still cameras/Camcorders
Input Signal		Composite Video & Y/C	Analog RGB	Y/Color Difference
Source supply voltage	For 12 V (or +5 V/−8 V) LCD panels*1	IR3Y18A  IR3Y31M	IR3Y34M IR3Y35M  RB5P0010M	
	For 5V LCD panels	IR3Y29AM/BM RB5P0060M RB5P006AM ★RB5P0070M*1	IR3Y26A/A1	IR3Y37M IR3Y37AM RB5P0020M RB5P0050M

\*1 IR3Y34M and IR3Y35M are applied to only LCD panels of 12 V source supply voltage.

\*2 For digital signal input panels

# SHARP

## SHARP CORPORATION

SALES & MARKETING GROUP

-ELECTRONIC COMPONENTS & DEVICES

22-22, NAGAIKE-CHO, ABENO-KU, OSAKA 545-8522, JAPAN

PHONE : (81) 6-6621-1221

FAX : (81) 6117-725300, (81) 6117-725301, (81) 6117-725302

http://sharp-world.com/products/device/index.html

### U.S.A.

#### SHARP MICROELECTRONICS OF THE AMERICAS

**North American Head Office**  
5700 North West Pacific Rim Boulevard  
Camas, WA 98607  
PHONE : (1) 360-834-2500  
FAX : (1) 360-834-8903  
http://www.sharpsma.com

**West**  
1980 Zanker Road, San Jose, CA 95112  
PHONE : (1) 408-436-4900  
FAX : (1) 408-436-0924

5901 Bolsa Avenue  
Huntington Beach, CA 92647-2053  
PHONE : (1) 714-903-4600  
FAX : (1) 714-903-0295

6390 Greenwich Drive Suite 175  
San Diego, CA 92122  
PHONE : (1) 858-597-0982  
FAX : (1) 858-597-8701

**Central**  
1834 Walden Office Court Suite 525  
Schaumburg, IL 06173  
PHONE : (1) 847-925-9150  
FAX : (1) 847-925-9172

1025 Royal Lane (PO Box 619035)  
DFW Airport, TX 75261-9035  
PHONE : (1) 972-456-8560  
FAX : (1) 972-456-0360

8911 Capitol of Texas Hwy. Suite 3220  
Austin, TX 78759  
PHONE : (1) 512-349-7262  
FAX : (1) 512-349-7002

9950 Cypresswood Suite 350  
Houston, TX 77070  
PHONE : (1) 281-955-9909  
FAX : (1) 281-955-9910

1731 Harmon Rd. Auburn Hills, MI 48326  
PHONE : (1) 248-391-5404  
FAX : (1) 248-391-6165

**East**  
200 Wheeler Rd., Burlington, MA 01803  
PHONE : (1) 781-270-7979  
FAX : (1) 781-229-9117

8000 Regency Parkway Suite 280  
Carey, NC 27511  
PHONE : (1) 919-460-0695  
FAX : (1) 919-460-0795

2321 Sidney St.  
Pittsburgh, PA 15203  
PHONE : (1) 412-381-1191  
FAX : (1) 412-381-1192

4400 North Federal Hwy. Suite 210  
Boca Raton, FL 33431  
PHONE : (1) 561-347-8690  
FAX : (1) 561-347-8692

### EUROPE

#### SHARP MICROELECTRONICS EUROPE

a division of Sharp Electronics (Europe) GmbH

**Head Office**  
Sonninstrasse 3, 20097, Hamburg,  
Germany  
PHONE : (49) 40-2376-2286  
FAX : (49) 40-2376-2232  
http://www.sharpsme.com/

**Germany :**  
**SME München Office**  
Fuerstenriederstrasse 5,  
80687 München, Germany  
PHONE : (49) 89-54 6842 0  
FAX : (49) 89-54 6842 50

**France :**  
**SME Paris Office**  
1 Rue Raoul Follereau  
Bussy Saint Georges  
77608 Marne la Vallée Cedex 3  
PHONE : (33) 1 6476 22 22  
FAX : (33) 1 6476 22 23

**Italy :**  
**SME Milano Office**  
Centro Direzionale Colleoni  
Palazzo Taurus Ingresso 2  
20041 Agrate Brianza, Milano, Italy  
PHONE : (390) 39-68 99 946  
FAX : (390) 39-68 99 948

**U.K. :**  
**SME London Office**  
Centennial Court, Easthampstead Road,  
Bracknell, Berkshire RG12 1YQ,  
United Kingdom  
PHONE : (44) 1344-86 99 22  
FAX : (44) 1344-36 09 03

**SME Scotland Office**  
Unit 46/47, Wren Court  
Grovewood Business Centre,  
Strathclyde Business Park,  
Bellshill ML4 3NQ,  
United Kingdom  
PHONE : (44) 1698-84 34 42  
FAX : (44) 1698-84 28 99

**Ireland :**  
**SME Dublin Office**  
First Floor, Block 1, St. Johns Court,  
Santry, Dublin 9, Ireland  
PHONE : (353) 1-842 87 05  
FAX : (353) 1-842 84 55

### ASIA

#### SHARP MICROELECTRONICS OF CHINA (SHANGHAI) CO., LTD.

28 Xin Jin Qiao Road King Tower 16F  
Pudong Shanghai 201206 P.R. China  
PHONE : (86) 21-5854-7710/21-5834-6056  
FAX : (86) 21-5854-4340/21-5834-6057

**Head Office**  
No. 360, Bashen Road,  
Xin Development Bldg 22,  
Waigaoqiao Free Trade Zone  
Shanghai 200131 P.R. China  
E-mail : smc@china.global.sharp.co.jp

#### SHARP-ROXY (HONG KONG) LTD.

3rd Business Division,  
17/F, Admiralty Centre, Tower 1,  
18 Harcourt Road, Hong Kong  
PHONE : (852) 28229311  
FAX : (852) 28660779  
http://www.sharp.com.hk

**Shenzhen Representative Office**  
Room 13B1, Tower C,  
Electronics Science & Technology Building,  
Shen Nan Zhong Road,  
Shenzhen, P.R. China  
PHONE : (86) 755-3273731  
FAX : (86) 755-3273735

#### SHARP ELECTRONIC COMPONENTS (TAIWAN) CORPORATION

8F-A, No. 16, Sec. 4, Nanking E. Rd.,  
Taipei, Taiwan  
PHONE : (886) 2-2577-7341  
FAX : (886) 2-2577-7326/2-2577-7328

#### SHARP ELECTRONICS (SINGAPORE) PTE., LTD.

396 Alexandra Road #07-00  
BP Tower Singapore 119954  
PHONE : (65) 271-3566  
FAX : (65) 271-3855

#### SHARP ELECTRONIC COMPONENTS (KOREA) CORPORATION

RM 501 Geosung ilsin 541, Dohwa-dong,  
Mapo-ku, Seoul, Korea, 121-701  
PHONE : (82) 2-711-5813 to 5818  
FAX : (82) 2-711-5819

The circuit application examples in this publication are provided to explain representative applications of SHARP devices and are not intended to guarantee any circuit design or license any intellectual property right. SHARP takes no responsibility for any problems related to any intellectual property right of a third party resulting from the use of SHARP devices.

SHARP reserves the right to make changes in the specifications, characteristics, data, materials, structures and other contents described herein at any time without notice in order to improve design or reliability.

Contact SHARP in order to obtain the latest device specification sheets before using any SHARP device. Manufacturing locations are also subject to change without notice.

In the absence of confirmation by device specification sheets, SHARP takes no responsibility for any defects that occur in equipment using any SHARP devices shown in catalogs, data books, etc.

Observe the following points when using any device in this publication. SHARP takes no responsibility for change caused by improper use of the devices, which does not meet the conditions and absolute maximum ratings for use specified in the relevant specification sheet nor meet the following conditions :

■ The devices in this publication are designed for use in general electronic equipment designs such as :

- Personal computers
- Office automation equipment
- Telecommunication equipment (except for trunk lines)
- Test and measurement equipment
- Industrial control
- Audio visual equipment
- Consumer electronics

■ Measures such as fail-safe function and redundant design should be taken to ensure reliability and safety when SHARP devices are used for or in connection with equipment that requires higher reliability such as :

- Main frame computers
- Transportation control and safety equipment (i.e. aircraft, trains, automobiles, etc.)
- Traffic signals
- Gas leakage sensor breakers
- Alarm equipment
- Various safety devices, etc.

■ SHARP devices shall not be used for or in connection with equipment that requires an extremely high level of reliability and safety such as :

- Military and aerospace applications
- Telecommunication equipment (trunk lines)
- Nuclear power control equipment
- Medical and other life support equipment (e.g., scuba)

If the SHARP devices listed in the publication fall within the scope of strategic products described in the Foreign Exchange and Foreign Trade Law of Japan, it is necessary to obtain approval to export such SHARP devices.

This publication is the proprietary product of SHARP and is copyrighted, with all rights reserved. Under the copyright laws, no part of this publication may be reproduced or transmitted in any form or by any means, electronic or mechanical for any purpose, in whole or in part, without the express written permission of SHARP.

Express written permission is also required before any use of this publication may be made by a third party.

Contact and consult with a SHARP representative if there are any questions about the contents of this publication.