

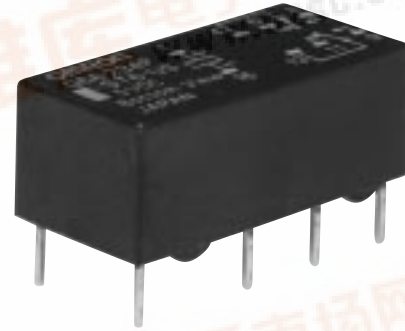

Low Signal Relay

G6A

- High sensitivity – can be driven by digital circuits
- Low-profile design allows use in 12.70 mm (0.50 in) PC board rack
- Surge withstand voltage meets FCC Part 68 regulation
- Units can be mounted side by side due to low magnetic leakage
- Special models available for ultrasonic cleaning and low thermoelectromotive force
- Unique moving loop (permanent magnet) armature reduces relay size, magnetic interference, and contact bounce time
- Single or double coil winding types available



Ordering Information

To Order: Select the part number and add the desired coil voltage rating, (e.g., G6A-274P-ST-US-DC12).

■ NON-LATCHING

Type	Contact form	Part number	
		AgPd (Au clad)	Ag (Au clad)
Standard	DPDT	G6A-234P-ST-US	G6A-274P-ST-US
	4PDT	G6A-434P-ST-US	G6A-474P-ST-US
High-sensitivity	DPDT	G6A-234P-ST15-US	G6A-274P-ST15-US
	4PDT	G6A-434P-ST20-US	G6A-474P-ST20-US
Low-sensitivity	DPDT	G6A-234P-ST40-US	G6A-274P-ST40-US
	4PDT	G6A-434P-ST40-US	G6A-474P-ST40-US

■ LATCHING

Single coil

Type	Contact form	Part number	
		AgPd (Au clad)	Ag (Au clad)
Standard	DPDT	G6AU-234P-ST-US	G6AU-274P-ST-US
	4PDT	G6AU-434P-ST-US	G6AU-474P-ST-US

Dual coil

Type	Contact form	Part number	
		AgPd (Au clad)	Ag (Au clad)
Standard	DPDT	G6AK-234P-ST-US	G6AK-274P-ST-US
	4PDT	G6AK-434P-ST-US	G6AK-474P-ST-US
Low-sensitivity	DPDT	G6AK-234P-ST40-US	G6AK-274P-ST40-US
	4PDT	G6AK-434P-ST40-US	G6AK-474P-ST40-US

Note: Other options available for ST10 ultra high reliability, high temperature 85°C (185°F), ST1 reverse coil polarity, BS British standard. Contact your OMRON sales representative for details.



Specifications

CONTACT DATA

Type	G6A-234P-ST(15, 40)-US, G6A-434P-ST(20, 40)-US G6AK-234P-ST(40)-US, G6AK-434P-ST(40)-US G6AU-234P-ST-US, G6AU-434P-ST-US		G6A-274P-ST(15, 40)-US, G6A-474P-ST(20, 40)-US G6AK-274P-ST(40)-US, G6AK-474P-ST(40)-US G6AU-274P-ST-US, G6AU-474P-ST-US	
Load	Resistive load (p.f. = 1)	Inductive load (p.f. = 0.4) (L/R = 7 ms)	Resistive load (p.f. = 1)	Inductive load (p.f. = 0.4) (L/R = 7 ms)
Rated load	0.30 A at 125 VAC, 1 A at 30 VDC	0.20 A at 125 VAC, 0.50 A at 30 VDC	0.50 A at 125 VAC, 2 A at 30 VDC	0.25 A at 125 VAC, 1 A at 30 VDC
Contact material	AgPd (Au clad)	AgPd (Au clad)	Ag (Au clad)	Ag (Au clad)
Carry current	3 A	3 A	3 A	3 A
Max. operating voltage	250 VAC, 220 VDC	250 VAC, 220 VDC	250 VAC, 220 VDC	250 VAC, 220 VDC
Max. operating current	2 A	1 A	2 A	1 A
Max. switching capacity	125 VA, 60 W	62.50 VA, 30 W	125 VA, 60 W	62.50 VA, 30 W
Min. permissible load	10 μA, 10 mVDC	10 μA, 10 mVDC	10 μA, 10 mVDC	10 μA, 10 mVDC

COIL DATA

Standard non-latching DPDT (G6A-234P-ST-US, G6A-274P-ST-US)

Rated voltage (VDC)	Rated current (mA)	Coil resistance (Ω)	Coil inductance (ref. value) (H)		Pick-up voltage	Dropout voltage	Maximum voltage	Power consumption (mW)
			Armature OFF	Armature ON				
3	66.70	45	0.07	0.07	70% max.	10% min.	200% at 23°C (73°F)	Approx. 200
5	40	125	0.20	0.18				
6	33.30	180	0.29	0.26				
9	22.20	405	0.63	0.57				
12	16.70	720	1.10	1.06				
24	8.30	2,880	4.50	4.10				
48	4.90	9,750	13.70	12.50			150% at 70°C (158°F)	Approx. 235

High-sensitivity non-latching DPDT (G6A-234P-ST15-US, G6A-274P-ST15-US)

Rated voltage (VDC)	Rated current (mA)	Coil resistance (Ω)	Coil inductance (ref. value) (H)		Pick-up voltage	Dropout voltage	Maximum voltage	Power consumption (mW)
			Armature OFF	Armature ON				
1.50	100	15	0.02	0.02	80% max.	10% min.	200%	Approx. 150
3	50	60	0.09	0.08				
4.50	33.30	135	0.22	0.20				
5	30	167	0.25	0.21				
6	25	240	0.35	0.31				
9	16.70	540	0.80	0.70				
12	12.50	960	1.35	1.25				
24	6.30	3,840	5.60	5.10				
48	3.20	15,000	22.50	20.00				

Note: The rated current and coil resistance are measured at a coil temperature of 23°C (73°F) with a tolerance of ±10%.

■ COIL DATA (continued)

Low-sensitivity non-latching DPDT (G6A-234P-ST40-US, G6A-274P-ST40-US)

Rated voltage (VDC)	Rated current (mA)	Coil resistance (Ω)	Coil inductance (ref. value) (H)		Pick-up voltage	Dropout voltage	Maximum voltage	Power consumption (mW)
			Armature OFF	Armature ON				
% of rated voltage								
3	133.30	22.50	0.03	0.02	70% max.	10% min.	150% at 23°C (73°F)	Approx. 400
5	80	62.50	0.08	0.07				
6	66.70	90	0.11	0.10				
9	44.30	203	0.27	0.23				
12	33.30	360	0.52	0.43				
24	16.70	1,440	2.10	1.80			110% at 70°C (158°F)	
48	8.30	5,760	7.50	6.40				

Standard non-latching 4PDT (G6A-434P-ST-US, G6A-474P-ST-US)

Rated voltage (VDC)	Rated current (mA)	Coil resistance (Ω)	Coil inductance (ref. value) (H)		Pick-up voltage	Dropout voltage	Maximum voltage	Power consumption (mW)
			Armature OFF	Armature ON				
% of rated voltage								
3	120	25	0.05	0.05	70% max.	10% min.	150% at 23°C (73°F)	Approx. 360
5	72.50	69	0.14	0.12				
6	60	100	0.20	0.17				
9	40	225	0.45	0.38				
12	30	400	0.80	0.68				
24	15	1,600	3.20	2.70			110% max. at 70°C (158°F)	
48	7.50	6,400	12.80	10.90				

High-sensitivity non-latching 4PDT (G6A-434P-ST20-US, G6A-474P-ST20-US)

Rated voltage (VDC)	Rated current (mA)	Coil resistance (Ω)	Coil inductance (ref. value) (H)		Pick-up voltage	Dropout voltage	Maximum voltage	Power consumption (mW)
			Armature OFF	Armature ON				
% of rated voltage								
3	66.70	45	—	—	70% max.	10% min.	200% max. at 50°C (122°F)	Approx. 200
5	40	125	—	—				
6	33.30	180	—	—				
9	22.20	405	—	—				
12	16.70	720	—	—				
24	8.30	2,880	—	—				
48	4.20	11,520	—	—				

Low-sensitivity non-latching 4PDT (G6A-434P-ST40-US, G6A-474P-ST40-US)

Rated voltage (VDC)	Rated current (mA)	Coil resistance (Ω)	Coil inductance (ref. value) (H)		Pick-up voltage	Dropout voltage	Maximum voltage	Power consumption (mW)
			Armature OFF	Armature ON				
% of rated voltage								
3	133.30	22.50	0.04	0.02	70% max.	10% min.	150% at 23°C (73°F)	Approx. 400
5	80	62.50	0.12	0.09				
6	66.70	90	0.17	0.13				
9	44.30	203	0.42	0.30				
12	33.30	360	0.70	0.52				
24	16.70	1,440	2.80	2.20			110% max. at 70°C (158°F)	
48	8.30	5,760	10.20	8.60				

Note: The rated current and coil resistance are measured at a coil temperature of 23°C (73°F) with a tolerance of ±10%.

■ COIL DATA (continued)

Standard single coil latching DPDT (G6AU-234P-ST-US, G6AU-274P-ST-US)

Rated voltage (VDC)	Rated current (mA)	Coil resistance (Ω)	Coil inductance (ref. value) (H)		Set pick-up voltage	Reset pick-up voltage	Maximum voltage	Power consumption (mW)
			Armature OFF	Armature ON				
3	33.70	89	0.15	0.11	70% max.	70% max.	200% at 23°C (73°F)	Approx. 100
5	20	250	0.44	0.35				
6	16.70	360	0.64	0.48				
9	11.10	810	1.38	1.07				
12	8.30	1,440	2.50	2				
24	4.20	5,760	9.20	7.20				
48	2.50	19,000	28.50	22			150% at 70°C (158°F)	Approx. 120

Standard dual coil latching DPDT (G6AK-234P-ST-US, G6AK-274P-ST-US)

Rated voltage (VDC)	Rated current (mA)	Coil resistance (Ω)	Coil inductance (ref. value) (H)				Set pick-up voltage	Reset pick-up voltage	Maximum voltage	Power consumption (mW)
			Set coil		Reset coil					
			Armature OFF	Armature ON	Armature OFF	Armature ON				
3	66.70	45	0.04	0.03	0.03	0.04	70% max.	70% max.	200% at 23°C (73°F)	Approx. 200
5	36	139	0.11	0.08	0.08	0.11				
6	30	200	0.16	0.12	0.12	0.16				
9	20	450	0.38	0.28	0.28	0.38				
12	15	800	0.60	0.45	0.45	0.60				
24	7.50	3,200	2.10	1.50	1.50	2.10				
48	4.20	11,520	8.50	6.30	6.30	8.50			150% max. at 70°C (158°F)	Approx. 180

Dual coil latching low-sensitivity DPDT (G6AK-234P-ST40-US, G6AK-274P-ST40-US)

Rated voltage (VDC)	Rated current (mA)	Coil resistance (Ω)	Coil inductance (ref. value) (H)				Set pick-up voltage	Reset pick-up voltage	Maximum voltage	Power consumption (mW)
			Set coil		Reset coil					
			Armature OFF	Armature ON	Armature OFF	Armature ON				
3	120	25	0.02	0.01	0.01	0.02	70% max.	70% max.	150% max. at 23°C (73°F)	Approx. 360
5	72.50	69	0.05	0.04	0.04	0.05				
6	60	100	0.07	0.05	0.05	0.07				
9	40	225	0.16	0.12	0.12	0.16				
12	30	400	0.28	0.20	0.20	0.28				
24	15	1,600	1.10	0.75	0.75	1.10				
48	7.50	6,400	4	2.90	2.9	4			110% max. at 70°C (158°F)	

Note: The rated current and coil resistance are measured at a coil temperature of 23°C (73°F) with a tolerance of ±10%.

■ COIL DATA (continued)

Standard single coil latching 4PDT (G6AU-434P-ST-US, G6AU-474P-ST-US)

Rated voltage (VDC)	Rated current (mA)	Coil resistance (Ω)	Coil inductance (ref. value) (H)		Set pick-up voltage	Reset pick-up voltage	Maximum voltage	Power consumption (mW)
			Armature OFF	Armature ON				
3	106.80	28.10	0.03	0.02	70% max.	70% max.	150% at 23°C (73°F)	Approx. 320
5	64	78.10	0.08	0.06				
6	53.30	112.50	0.11	0.08				
9	35.60	253	0.25	0.18			110% at 70°C (158°F)	
12	26.70	450	0.45	0.32				
24	13.30	1,800	1.80	1.30				
48	6.70	7,200	7.00	5.20				

Standard dual coil latching 4PDT (G6AK-434P-ST-US, G6AK-474P-ST-US)

Rated voltage (VDC)	Rated current (mA)	Coil resistance (Ω)	Coil inductance (ref. value) (H)				Set pick-up voltage	Reset pick-up voltage	Maximum voltage	Power consumption (mW)
			Set coil		Reset coil					
			Armature OFF	Armature ON	Armature OFF	Armature ON				
3	106.80	28.10	0.03	0.02	0.02	0.03	70% max.	70% max.	150% at 23°C (73°F)	Approx. 320
5	64	78.10	0.08	0.06	0.06	0.08				
6	53.30	112.50	0.11	0.08	0.08	0.11				
9	35.60	253	0.25	0.18	0.18	0.25			110% max. at 70°C (158°F)	
12	26.70	450	0.45	0.32	0.32	0.45				
24	13.30	1,800	1.80	1.30	1.30	1.80				
48	6.70	7,200	7.00	5.20	5.20	7.00				

Dual coil latching low-sensitivity 4PDT (G6AK-434P-ST40-US, G6AK-474P-ST40-US)

Rated voltage (VDC)	Rated current (mA)	Coil resistance (Ω)	Coil inductance (ref. value) (H)				Set pick-up voltage	Reset pick-up voltage	Maximum voltage	Power consumption (mW)
			Set coil		Reset coil					
			Armature OFF	Armature ON	Armature OFF	Armature ON				
3	120	25	0.02	0.02	0.02	0.02	70% max.	70% max.	150% max. at 23°C (73°F)	Approx. 360
5	72.50	69	0.07	0.05	0.05	0.07				
6	60	100	0.09	0.08	0.08	0.09				
9	40	225	0.18	0.14	0.14	0.18			110% max. at 70°C (158°F)	
12	30	400	0.30	0.23	0.23	0.30				
24	15	1,600	1.20	0.82	0.82	1.20				
48	7.50	6,400	4.40	3.20	3.20	4.40				

Note: The rated current and coil resistance are measured at a coil temperature of 23°C (73°F) with a tolerance of ±10%.

CHARACTERISTICS

Type		Non-latching	Latching
Contact resistance		50 mΩ max.	
Operate (set) time	DPDT	5 ms max. (mean value: approx. 3 ms)	5 ms max. (mean value: approx. 2.50 ms)
	4PDT	7 ms max. (mean value: approx. 3.80 ms)	7 ms max. (mean value: approx. 3.30 ms)
Release (reset) time	DPDT	3 ms max. (mean value: approx. 1.20 ms)	5 ms max. (mean value: approx. 2.50 ms)
	4PDT	5 ms max. (mean value: approx. 1.30 ms)	7 ms max. (mean value: approx. 2.70 ms)
Bounce time	Operate	Actual value approx. 0.50 ms	
	Release	Actual value approx. 0.50 ms	
Operating frequency	Mechanical	36,000 operations/hour	
	Electrical	1,800 operations/hour (under rated load)	
Insulation resistance		1,000 MΩ min. (at 500 VDC)	
Dielectric strength (see note 2)		1,000 VAC, 50/60 Hz for 1 minute between coil and contacts	
		1,000 VAC, 50/60 Hz for 1 minute between contacts of different poles	
		1,000 VAC, 50/60 Hz for 1 minute between contacts of same pole	
		250 VAC, 50/60 Hz for 1 minute between set and reset coils	
Surge withstand voltage (see note 3)		1,500 V 10 x 160 μs (conforms to FCC Part 68)	
Vibration	Mechanical durability	10 to 55 Hz; 5 mm (0.20 in) double amplitude	
	Malfunction durability	10 to 55 Hz; 3.30 mm (0.13 in) double amplitude	
Shock	Mechanical durability	1,000 m/s ² (Approx. 100 G)	
	Malfunction durability	DPDT: 500 m/s ² (Approx. 50 G); 4PDT: 300 m/s ² (Approx. 30 G)	
Ambient temperature		-40° to 70°C (-40° to 158°F)	
Humidity		45% to 85% RH	
Service life (see note 4)	Mechanical	100 million operations min. (at 36,000 operations/hour)	
	Electrical	See "Characteristic Data"	
Weight	DPDT	Approx. 3.5 g (0.12 oz)	
	4PDT	Approx. 6.0 g (0.21 oz)	

- Note: 1. Data shown are of initial value.
 2. The dielectric strength of Type G6A-2D34P-ST-US is 500 VAC when the relay is not energized.
 3. The surge withstand of Type G6A-2D34P-ST-US is 1,000 V 10 x 160 μs when the relay is not energized.
 4. The mechanical service life of Type G6A-2D34P-ST-US is 10,000,000 operations min.

CHARACTERISTIC DATA

Maximum switching capacity DPDT

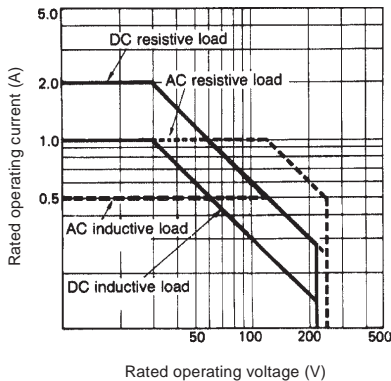

Ambient temperature vs. maximum voltage (reference only)

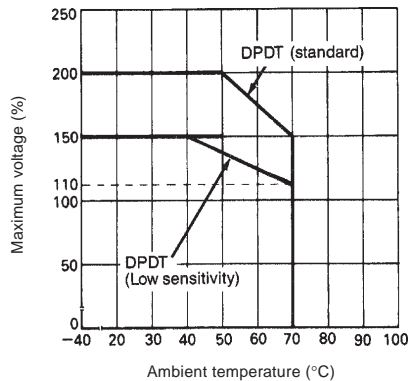

Electrical service life DPDT

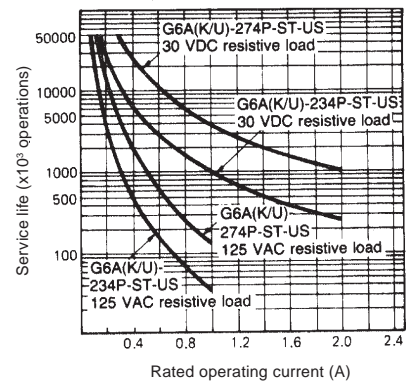

Dimensions

Unit: mm (inch)

■ NON-LATCHING

G6A-234P-ST(15, 40)-US, G6A-274P-ST(15, 40)-US

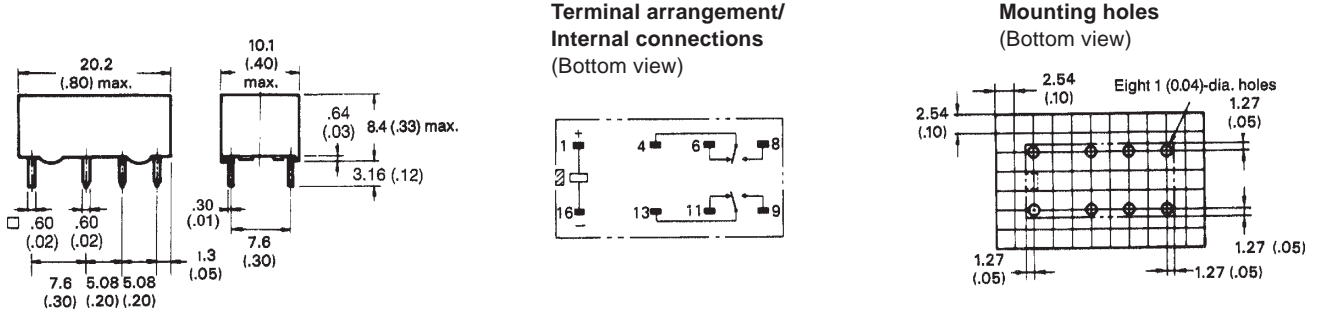

G6A-434P-ST(20, 40)-US, G6A-474P-ST(20, 40)-US

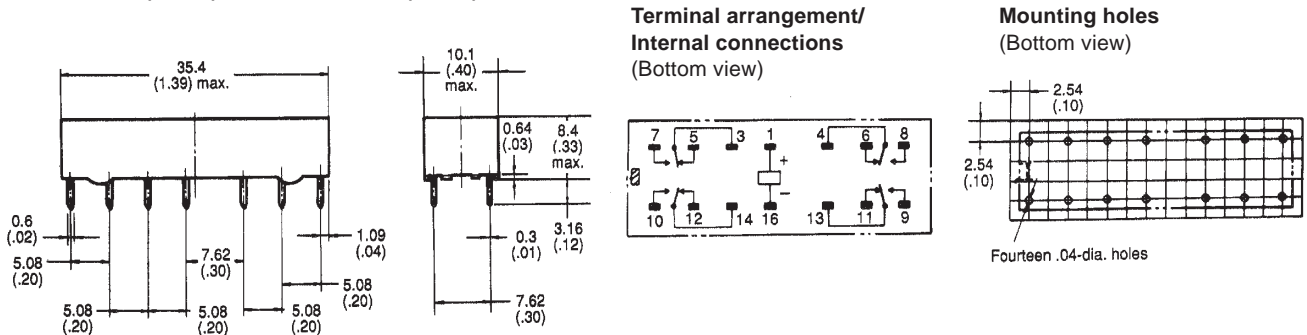

■ LATCHING

G6AU-234P-ST-US, G6AU-274P-ST-US

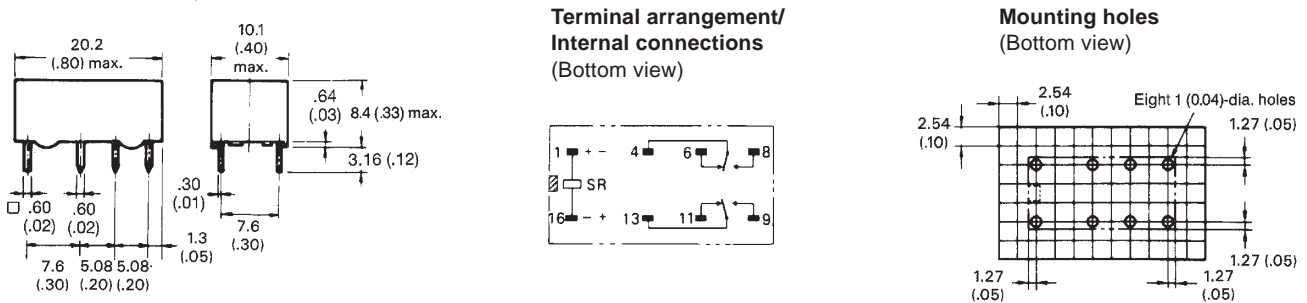

G6AK-234P-ST(40)-US, G6AK-274P-ST(40)-US

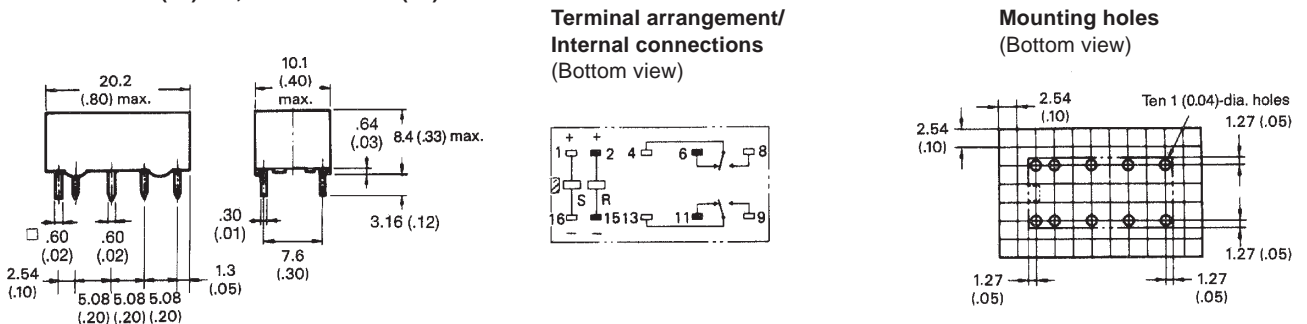

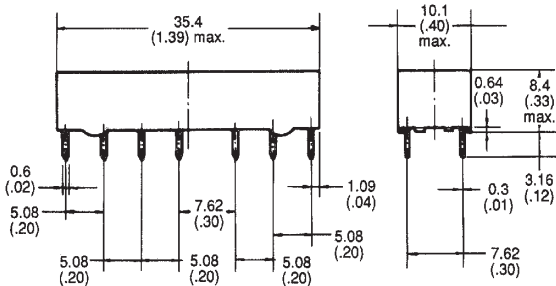
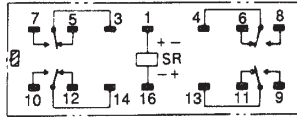
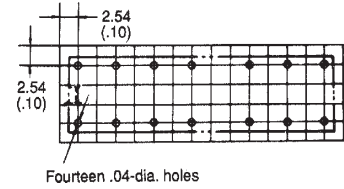

Note:  and  indicate mounting orientation marks.

G6AU-434P-ST-US, G6AU-474P-ST-US

Terminal arrangement/
Internal connections
(Bottom view)Mounting holes
(Bottom view)

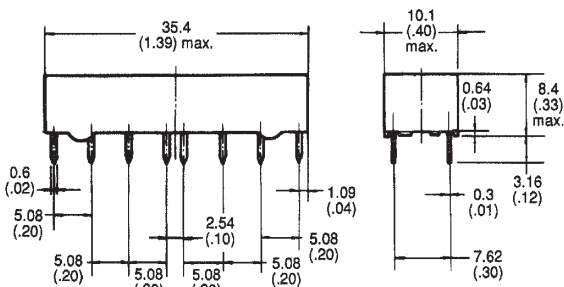
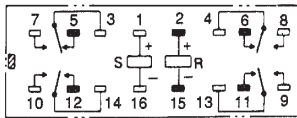
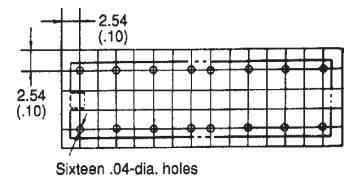
G6AK-434P-ST(40)-US, G6AK-474P-ST(40)-US

Terminal arrangement/
Internal connections
(Bottom view)Mounting holes
(Bottom view)

Note:  and  indicate mounting orientation marks.

APPROVALS

UL (File No. E41515)/CSA (File No. LR24825)

Type	Contact form	Coil rating	Contact ratings
G6A-234P-ST-US	DPDT	1 to 48 VDC	0.60 A, 125 VAC
G6A-234P-ST40-US			1 A, 30 VDC
G6A-234P-ST15-US			0.60 A, 110 V+DC
G6A-274P-ST-US	DPDT	1 to 48 VDC	0.60 A, 125 VAC
G6A-274P-ST40-US			2 A, 30 VDC
G6A-274P-ST15-US			0.60 A, 110 VDC
G6A-434P-ST-US	4PDT	1 to 48 VDC	0.60 A, 125 VAC
G6A-434P-ST20-US			1 A, 30 VDC
G6A-434P-ST40-US			0.60 A, 110 VDC
G6A-474P-ST-US	4PDT	1 to 48 VDC	0.60 A, 125 VAC
G6A-474P-ST20-US			2 A, 30 VDC
G6A-474P-ST40-US			0.60 A, 110 VDC
G6AK-234P-ST(40)-US	DPDT	1 to 48 VDC	0.60 A, 125 VAC
G6AU-234P-ST-US			1 A, 30 VDC
			0.60 A, 110 VDC
G6AK-274P-ST(40)-US	DPDT	1 to 48 VDC	0.60 A, 125 VAC
G6AU-274P-ST-US			2 A, 30 VDC
			0.60 A, 110 VDC
G6AK-434P-ST(40)-US	4PDT	1 to 48 VDC	0.60 A, 125 VAC
G6AU-434P-ST(40)-US			1 A, 30 VDC
			0.60 A, 110 VDC
G6AK-474P-ST(40)-US	4PDT	1 to 48 VDC	0.60 A, 125 VAC
G6AU-474P-ST(40)-US			2 A, 30 VDC
			0.60 A, 110 VDC

Note: 1. The rated values approved by each of the safety standards (e.g., UL and CSA) may be different from the performance characteristics individually defined in this catalog.

2. In the interest of product improvement, specifications are subject to change.

OMRON

OMRON ELECTRONICS, INC.
One East Commerce Drive
Schaumburg, IL 60173
1-800-55-OMRON

OMRON CANADA, INC.
885 Milner Avenue
Scarborough, Ontario M1B 5V8
416-286-6465