



AAT3238 300mA MicroPower™ High Performance LDO

PowerLinear™

General Description

The AAT3238 MicroPower™ Low Dropout Linear Regulator is ideally suited for portable applications where very fast transient response, extended battery life and small size are critical. The AAT3238 has been specifically designed for high speed turn on and turn off performance, fast transient response, good power supply ripple rejection (PSRR) and is reasonably low noise, making it ideal for powering sensitive circuits with fast switching requirements.

Other features include low quiescent current, typically 70µA, and low dropout voltage which is typically less than 400mV at the maximum output current level of 300mA. The device is output short circuit protected and has a thermal shutdown circuit for additional protection under extreme operating conditions.

The AAT3238 also features a low-power shutdown mode for extended battery life. A reference bypass pin has been provided to improve PSRR performance and output noise, by connecting a small external capacitor from the AAT3238's reference output to ground.

The AAT3238 is available in a space saving 6-pin SOT23 or 8-pin SC70JW package in factory programmed voltages.

Features

- Low Dropout - 400mV at 300mA
- Guaranteed 300mA Output
- High accuracy $\pm 1.5\%$
- 70µA Quiescent Current
- Fast line and load transient response
- High speed device turn-on and shutdown
- High Power Supply Ripple Rejection
- Low self noise
- Short circuit protection
- Over-Temperature protection
- Uses Low ESR ceramic capacitors
- Noise reduction bypass capacitor
- Shutdown mode for longer battery life
- Low temperature coefficient
- Factory programmed output voltages
- SOT23 6-pin or SC70JW 8-pin package

Applications

- Cellular Phones
- Notebook Computers
- Portable Communication Devices
- Personal Portable Electronics
- Digital Cameras

Typical Application

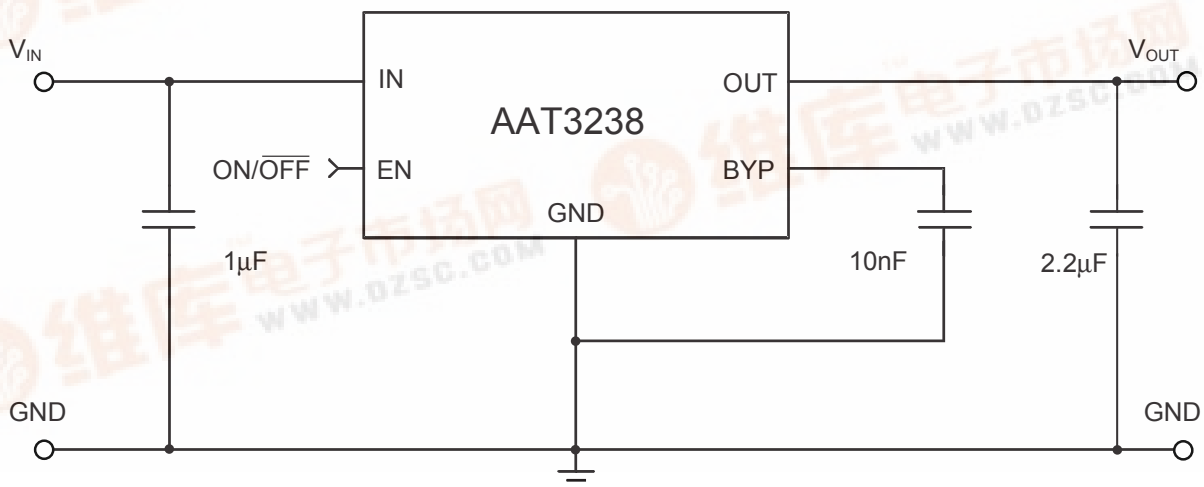

Pin Descriptions

Pin #		Symbol	Function
SOT23-6	SC70JW-8		
1	5, 6	IN	Input voltage pin - should be decoupled with 1 μ F or greater capacitor.
2, 5	8	GND	Ground connection pin
3	7	EN	Enable pin - this pin should not be left floating. When pulled low the PMOS pass transistor turns off and all internal circuitry enters low-power mode, consuming less than 1 μ A.
4	1	BYP	Bypass capacitor connection - to improve AC ripple rejection, connect a 10nF capacitor to GND. This will also provide a soft start function.
6	2, 3, 4	OUT	Output pin - should be decoupled with 2.2 μ F ceramic capacitor.

Pin Configuration

SOT23-6
(Top View)

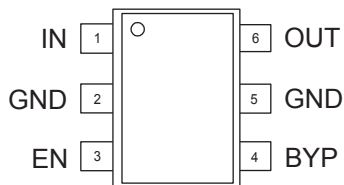

SC70JW-8
(Top View)

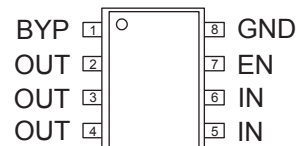

Absolute Maximum Ratings (T_A=25°C unless otherwise noted)

Symbol	Description	Value	Units
V _{IN}	Input Voltage	6	V
V _{ENIN(MAX)}	Maximum EN to Input Voltage	0.3	V
I _{OUT}	DC Output Current	P _D /(V _{IN} -V _O)	mA
T _J	Operating Junction Temperature Range	-40 to 150	°C

Note: Stresses above those listed in Absolute Maximum Ratings may cause permanent damage to the device. Functional operation at conditions other than the operating conditions specified is not implied. Only one Absolute Maximum rating should be applied at any one time.

Thermal Information

Symbol	Description	Rating	Units
Θ _{JA}	Maximum Thermal Resistance ¹ (SOT23-6, SC70JW-8)	150	°C/W
P _D	Maximum Power Dissipation ¹ (SOT23-6, SC70JW-8)	667	mW

Note 1: Mounted on a demo board.

Recommended Operating Conditions

Symbol	Description	Rating	Units
V _{IN}	Input Voltage	(V _{OUT} +V _{DO}) to 5.5	V
T	Ambient Temperature Range ²	-40 to +85	°C

Note 2: To calculate minimum input voltage, use the following equation: V_{IN(MIN)} = V_{OUT(MAX)} + V_{DO(MAX)} as long as V_{IN} ≥ 2.5V.

Electrical Characteristics ($V_{IN}=V_{OUT(NOM)}+1V$ for V_{OUT} options greater than 1.5V. $V_{IN}=2.5$ for $V_{OUT}\leq 1.5V$. $I_{OUT}=1mA$, $C_{OUT}=2.2\mu F$, $C_{IN}=1\mu f$, $T_A=-40$ to $85^\circ C$ unless otherwise noted. Typical values are $T_A=25^\circ C$)

Symbol	Description	Conditions	Min	Typ	Max	Units	
V_{OUT}	Output Voltage Tolerance	$I_{OUT} = 1mA$ to $300mA$	$T_A=25^\circ C$	-1.5		1.5	%
			$T_A=-40$ to $85^\circ C$	-2.5		2.5	%
I_{OUT}	Output Current	$V_{OUT} > 1.2V$		300		mA	
V_{DO}	Dropout Voltage ^{1,2}	$I_{OUT} = 300mA$		400	600	mV	
I_{SC}	Short Circuit Current	$V_{OUT} < 0.4V$		600		mA	
I_Q	Ground Current	$V_{IN} = 5V$, No load, $EN = V_{IN}$		70	125	μA	
I_{SD}	Shutdown Current	$V_{IN} = 5V$, $EN = 0V$			1	μA	
$\frac{\Delta V_{OUT}}{V_{OUT}} \div \Delta V_{IN}$	Line Regulation	$V_{IN} = V_{OUT} + 1$ to $5.0V$			0.09	%/V	
$\Delta V_{OUT}(\text{line})$	Dynamic Line Regulation	$V_{IN}=V_{OUT}+1V$ to $V_{OUT}+2V$, $I_{OUT}=300mA$, $T_R/T_F=2\mu s$		2.5		mV	
$\Delta V_{OUT}(\text{load})$	Dynamic Load Regulation	$I_{OUT} = 1mA$ to $300mA$, $T_R<5\mu s$		60		mV	
t_{ENDLY}	Enable Delay Time	BYP = open		15		μs	
$V_{EN(L)}$	Enable Threshold Low				0.6	V	
$V_{EN(H)}$	Enable Threshold High		1.5			V	
I_{EN}	Leakage Current on Enable Pin	$V_{EN} = 5V$			1	μA	
PSRR	Power Supply Rejection Ratio	$I_{OUT}=10mA$, $C_{BYP}=10nF$	1 kHz		67		dB
			10kHz		47		
			1MHz		45		
T_{SD}	Over Temp Shutdown Threshold			145		$^\circ C$	
T_{HYS}	Over Temp Shutdown Hysteresis			12		$^\circ C$	
e_N	Output Noise	Noise Power BW = 300Hz-50kHz		50		$\mu V_{rms}/rtHz$	
TC	Output Voltage Temp. Coeff.			22		ppm/ $^\circ C$	

Note 1: V_{DO} is defined as $V_{IN} - V_{OUT}$ when V_{OUT} is 98% of nominal.

Note 2: For $V_{OUT} < 2.1V$, $V_{DO} = 2.5V - V_{OUT}$.

Typical Characteristics

(Unless otherwise noted, $V_{IN} = 5V$, $T_A = 25^\circ C$)

Dropout Voltage vs. Temperature

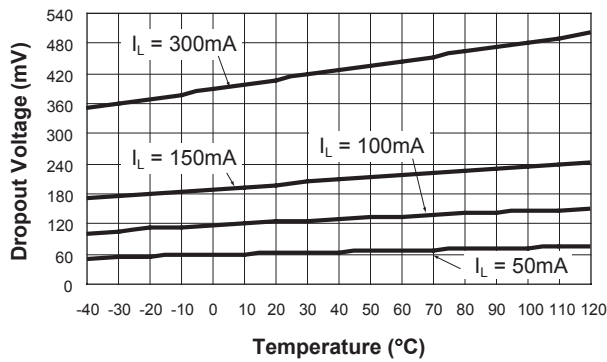

Dropout Characteristics

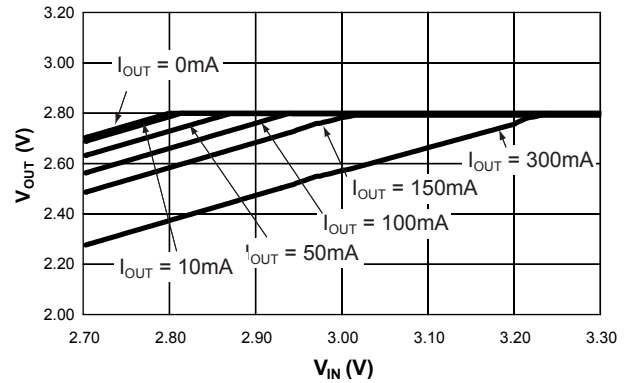

Dropout Voltage vs. Output Current

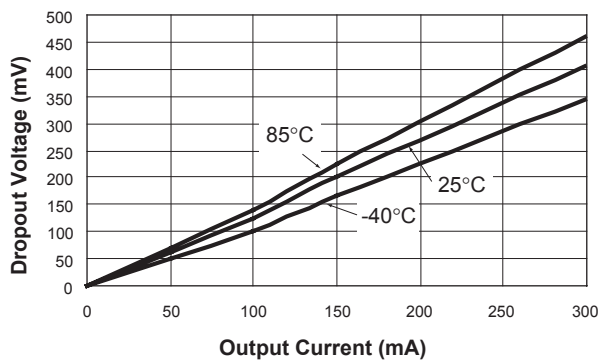

Ground Current vs. Input Voltage

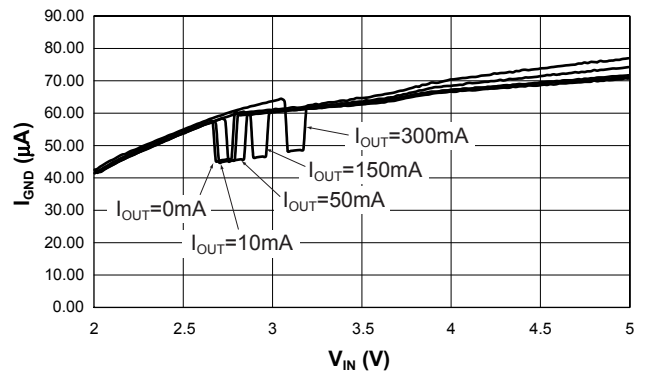

Quiescent Current vs. Temperature

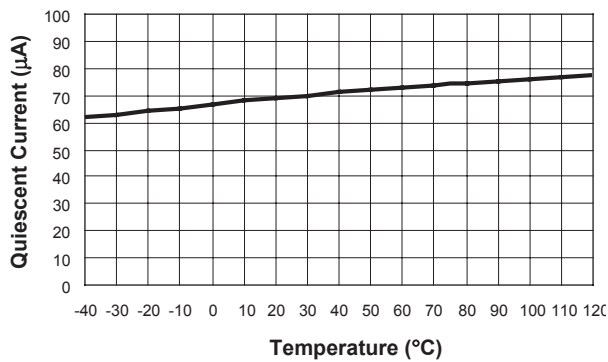

Output Voltage vs. Temperature

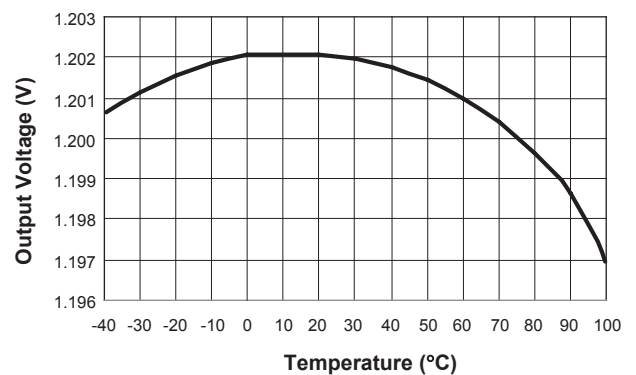

Typical Characteristics

(Unless otherwise noted, $V_{IN} = 5V$, $T_A = 25^\circ C$)

Initial Power Up Response Time
 $C_{BYP}=10nF$

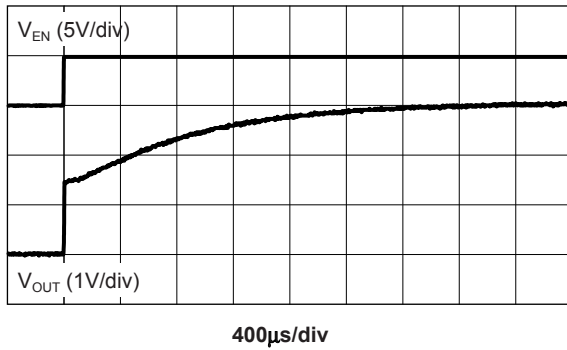

Turn-OFF Response Time
 $C_{BYP}=10nF$

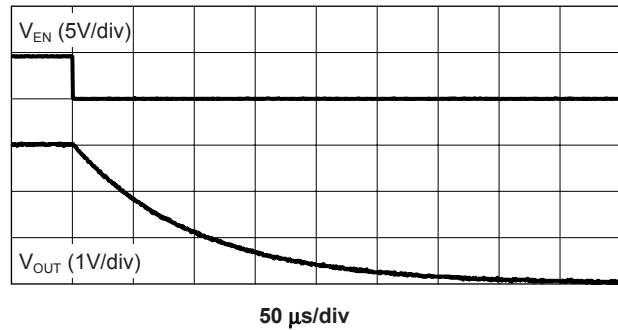

Turn-ON Time From Enable (V_{IN} present)
 $C_{BYP} = 10nF$

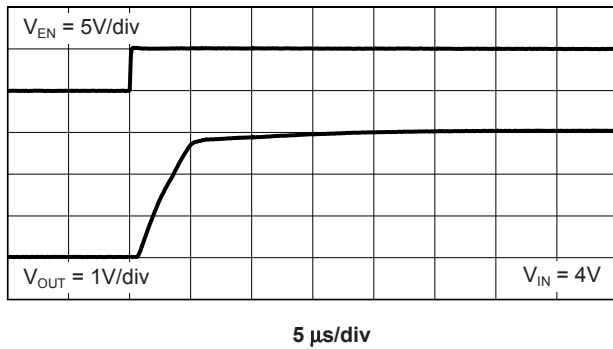

Line Transient Response

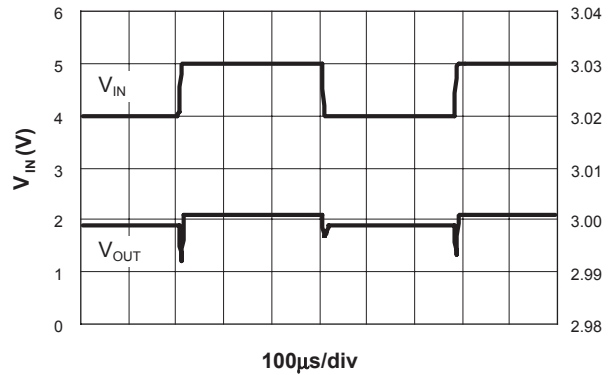

Load Transient Response

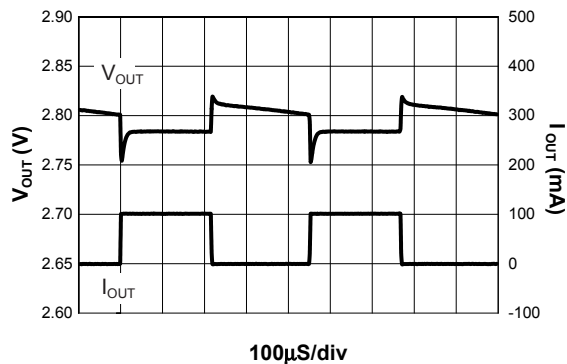

Load Transient Response 300mA

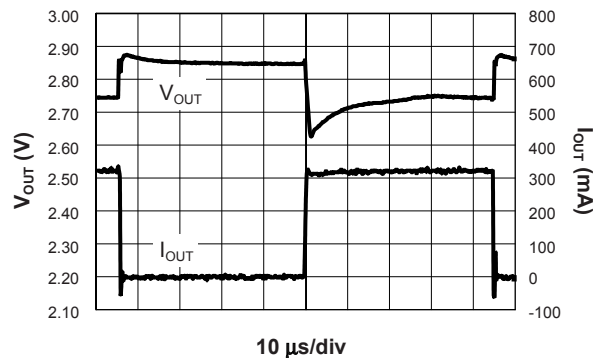

Typical Characteristics

(Unless otherwise noted, $V_{IN} = 5V$, $T_A = 25^\circ C$)

AAT3238 Self Noise
 $C_{OUT} = 10\mu F$ (ceramic)

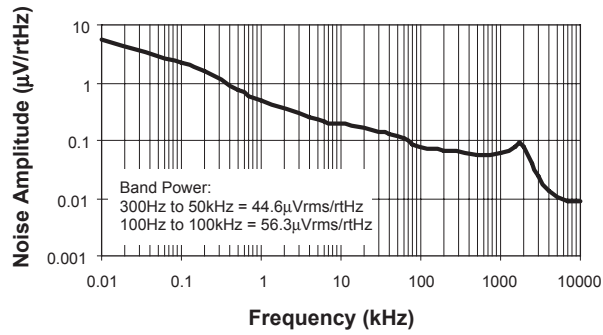

Over Current Protection

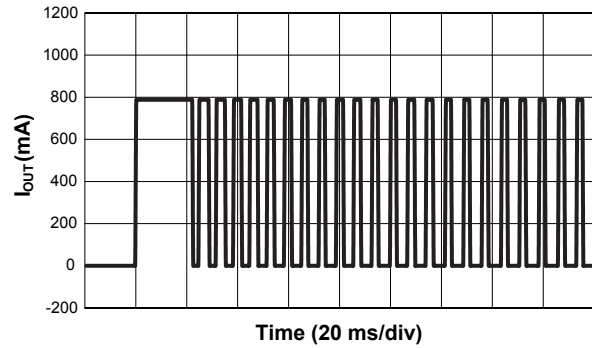

V_{IH} and V_{IL} vs. V_{IN}

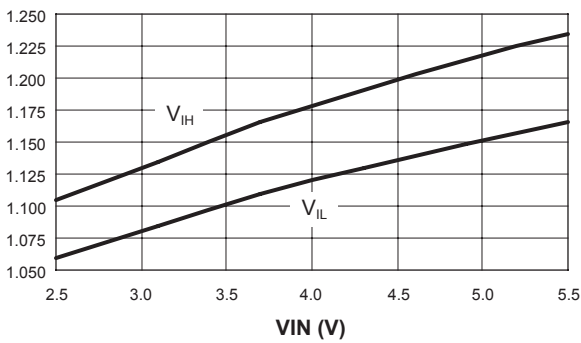

Functional Block Diagram

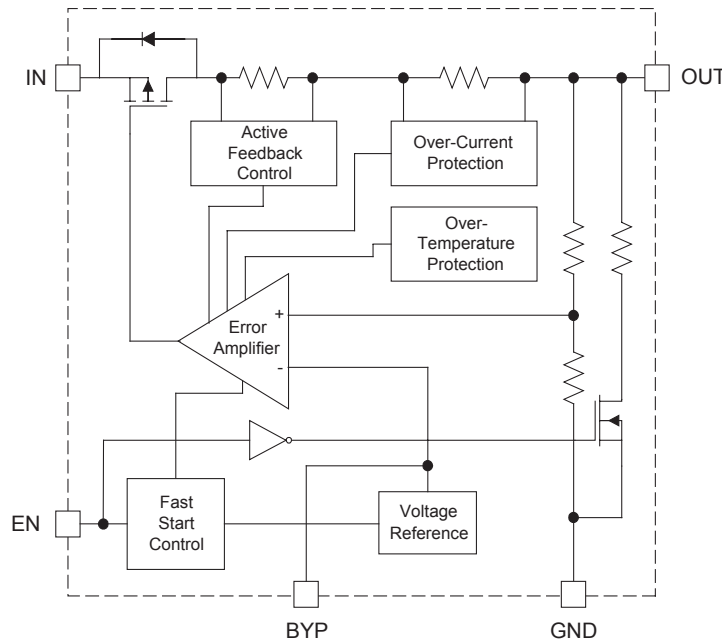

Functional Description

The AAT3238 is intended for LDO regulator applications where output current load requirements range from no load to 300mA.

The advanced circuit design of the AAT3238 has been specifically optimized for very fast start-up and shutdown timing. This proprietary CMOS LDO has also been tailored for superior transient response characteristics. These traits are particularly important for applications, which require fast power supply timing, such as GSM cellular telephone handsets.

The high-speed turn-on capability of the AAT3238 is enabled through the implementation of a fast start control circuit, which accelerates the power up behavior of fundamental control and feedback circuits within the LDO regulator.

Fast turn-off time response is achieved by an active output pull down circuit, which is enabled when the LDO regulator is placed in the shutdown mode. This active fast shutdown circuit has no adverse effect on normal device operation.

The AAT3238 has very fast transient response characteristics, which is an important feature for applications where fast line and load transient response is

required. This rapid transient response behavior is accomplished through the implementation of an active error amplifier feedback control. This proprietary circuit design is unique to this MicroPower™ LDO regulator.

The LDO regulator output has been specifically optimized to function with low cost, low ESR ceramic capacitors. However, the design will allow for operation over a wide range of capacitor types.

A bypass pin has been provided to allow the addition of an optional voltage reference bypass capacitor to reduce output self noise and increase power supply ripple rejection. Device self noise and PSRR will be improved by the addition of a small ceramic capacitor in this pin. However, increased values of C_{BYPASS} may slow down the LDO regulator turn-on time.

This LDO regulator has complete short circuit and thermal protection. The integral combination of these two internal protection circuits give the AAT3238 a comprehensive safety system to guard against extreme adverse operating conditions. Device power dissipation is limited to the package type and thermal dissipation properties. Refer to the thermal considerations discussion in the section for details on device operation at maximum output current loads.

Applications Information

To assure the maximum possible performance is obtained from the AAT3238, please refer to the following application recommendations.

Input Capacitor

Typically a 1 μ F or larger capacitor is recommended for C_{IN} in most applications. A C_{IN} capacitor is not required for basic LDO regulator operation. However, if the AAT3238 is physically located more than 3 centimeters from an input power source, a C_{IN} capacitor will be needed for stable operation. C_{IN} should be located as close to the device V_{IN} pin as practically possible. C_{IN} values greater than 1 μ F will offer superior input line transient response and will assist in maximizing the highest possible power supply ripple rejection.

Ceramic, tantalum or aluminum electrolytic capacitors may be selected for C_{IN} . There is no specific capacitor ESR requirement for C_{IN} . However, for 300mA LDO regulator output operation, ceramic capacitors are recommended for C_{IN} due to their inherent capability over tantalum capacitors to withstand input current surges from low impedance sources such as batteries in portable devices.

Output Capacitor

For proper load voltage regulation and operational stability, a capacitor is required between pins V_{OUT} and GND. The C_{OUT} capacitor connection to the LDO regulator ground pin should be made as direct as practically possible for maximum device performance.

The AAT3238 has been specifically designed to function with very low ESR ceramic capacitors. For best performance, ceramic capacitors are recommended.

Typical output capacitor values for maximum output current conditions range from 1 μ F to 10 μ F. Applications utilizing the exceptionally low output noise and optimum power supply ripple rejection characteristics of the AAT3238 should use 2.2 μ F or greater for C_{OUT} . If desired, C_{OUT} may be increased without limit.

In low output current applications where output load is less than 10mA, the minimum value for C_{OUT} can be as low as 0.47 μ F.

Bypass Capacitor and Low Noise Applications

A bypass capacitor pin is provided to enhance the low noise characteristics of the AAT3238 LDO regulator. The bypass capacitor is not necessary for operation of the AAT3238. However, for best device performance, a small ceramic capacitor should be placed between the Bypass pin (BYP) and the device ground pin (GND). The value of C_{BYP} may range from 470pF to 10nF. For lowest noise and best possible power supply ripple rejection performance a 10nF capacitor should be used. To practically realize the highest power supply ripple rejection and lowest output noise performance, it is critical that the capacitor connection between the BYP pin and GND pin be direct and PCB traces should be as short as possible. Refer to the PCB Layout Recommendations section of this document for examples.

There is a relationship between the bypass capacitor value and the LDO regulator turn on time and turn off time. In applications where fast device turn on time and turn off time is desired, the value of C_{BYP} should be reduced.

In applications where low noise performance and/or ripple rejection are less of a concern, the bypass capacitor may be omitted. The fastest device turn on time will be realized when no bypass capacitor is used.

DC leakage on this pin can affect the LDO regulator output noise and voltage regulation performance. For this reason, the use of a low leakage, high quality ceramic (NPO or COG type) or film capacitor is highly recommended.

Capacitor Characteristics

Ceramic composition capacitors are highly recommended over all other types of capacitors for use with the AAT3238. Ceramic capacitors offer many advantages over their tantalum and aluminum electrolytic counterparts. A ceramic capacitor typically has very low ESR, is lower cost, has a smaller PCB footprint and is non-polarized. Line and load transient response of the LDO regulator is improved by using low ESR ceramic capacitors. Since ceramic capacitors are non-polarized, they are not prone to incorrect connection damage.

Applications Information

Equivalent Series Resistance (ESR): ESR is a very important characteristic to consider when selecting a capacitor. ESR is the internal series resistance associated with a capacitor, which includes lead resistance, internal connections, size and area, material composition and ambient temperature. Typically capacitor ESR is measured in milliohms for ceramic capacitors and can range to more than several ohms for tantalum or aluminum electrolytic capacitors.

Ceramic Capacitor Materials: Ceramic capacitors less than 0.1 μ F are typically made from NPO or COG materials. NPO and COG materials are typically tight tolerance very stable over temperature. Larger capacitor values are typically composed of X7R, X5R, Z5U and Y5V dielectric materials. Large ceramic capacitors, typically greater than 2.2 μ F are often available in the low cost Y5V and Z5U dielectrics. These two material types are not recommended for use with LDO regulators since the capacitor tolerance can vary more than $\pm 50\%$ over the operating temperature range of the device. A 2.2 μ F Y5V capacitor could be reduced to 1 μ F over temperature, this could cause problems for circuit operation. X7R and X5R dielectrics are much more desirable. The temperature tolerance of X7R dielectric is better than $\pm 15\%$.

Capacitor area is another contributor to ESR. Capacitors which are physically large in size will have a lower ESR when compared to a smaller sized capacitor of an equivalent material and capacitance value. These larger devices can improve circuit transient response when compared to an equal value capacitor in a smaller package size.

Consult capacitor vendor data sheets carefully when selecting capacitors for LDO regulators.

Enable Function

The AAT3238 features an LDO regulator enable/disable function. This pin (EN) is active high and is compatible with CMOS logic. To assure the LDO regulator will switch on, the EN turn on control level must be greater than 1.5 volts. The LDO regulator will go into the disable shutdown mode when the voltage on the EN pin falls below 0.6 volts. If the enable function is not needed in a specific application, it may be tied to V_{IN} to keep the LDO regulator in a continuously on state.

When the LDO regulator is in the shutdown mode, an internal 1.5k Ω resistor is connected between V_{OUT} and GND. This is intended to discharge C_{OUT} when the LDO regulator is disabled. The internal 1.5k Ω has no adverse effect on device turn on time.

Short Circuit Protection

The AAT3238 contains an internal short circuit protection circuit that will trigger when the output load current exceeds the internal threshold limit. Under short circuit conditions the output of the LDO regulator will be current limited until the short circuit condition is removed from the output or LDO regulator package power dissipation exceeds the device thermal limit.

Thermal Protection

The AAT3238 has an internal thermal protection circuit which will turn on when the device die temperature exceeds 145°C. The internal thermal protection circuit will actively turn off the LDO regulator output pass device to prevent the possibility of over temperature damage. The LDO regulator output will remain in a shutdown state until the internal die temperature falls back below the 145°C trip point.

The combination and interaction between the short circuit and thermal protection systems allow the LDO regulator to withstand indefinite short circuit conditions without sustaining permanent damage.

No-Load Stability

The AAT3238 is designed to maintain output voltage regulation and stability under operational no-load conditions. This is an important characteristic for applications where the output current may drop to zero.

Reverse Output to Input Voltage Conditions and Protection

Under normal operating conditions a parasitic diode exists between the output and input of the LDO regulator. The input voltage should always remain greater than the output load voltage maintaining a reverse bias on the internal parasitic diode. Conditions where V_{OUT} might exceed V_{IN} should be avoided since this would forward bias the internal parasitic diode and allow excessive current flow into the V_{OUT} pin possibly damaging the LDO regulator.



Applications Information

In applications where there is a possibility of V_{OUT} exceeding V_{IN} for brief amounts of time during normal operation, the use of a larger value C_{IN} capacitor is highly recommended. A larger value of C_{IN} with respect to C_{OUT} will effect a slower C_{IN} decay rate during shutdown, thus preventing V_{OUT} from exceeding V_{IN} . In applications where there is a greater danger of V_{OUT} exceeding V_{IN} for extended periods of time, it is recommended to place a Schottky diode across V_{IN} to V_{OUT} (connecting the cathode to V_{IN} and anode to V_{OUT}). The Schottky diode forward voltage should be less than 0.45 volts.

Ordering Information

Output Voltage	Package	Marking ¹	Part Number (Tape and Reel)
1.2V	SOT23-6	KIXYY	AAT3238IGU-1.2-T1
1.5V	SOT23-6	JGXYY	AAT3238IGU-1.5-T1
1.6V	SOT23-6	JSXYY	AAT3238IGU-1.6-T1
1.8V	SOT23-6	JRXYY	AAT3238IGU-1.8-T1
1.85V	SOT23-6	JFYXX	AAT3238IGU-1.85-T1
2.0V	SOT23-6		AAT3238IGU-2.0-T1
2.3V	SOT23-6		AAT3238IGU-2.3-T1
2.5V	SOT23-6	KUXYY	AAT3238IGU-2.5-T1
2.7V	SOT23-6		AAT3238IGU-2.7-T1
2.8V	SOT23-6	FCXYY	AAT3238IGU-2.8-T1
2.85	SOT23-6		AAT3238IGU-2.85-T1
3.0V	SOT23-6		AAT3238IGU-3.0-T1
3.3V	SOT23-6		AAT3238IGU-3.3-T1
3.5V	SOT23-6		AAT3238IGU-3.5-T1
1.2V	SC70JW-8	KIXYY	AAT3238IJS-1.2-T1
1.45V	SC70JW-8	LFXYY	AAT3238IJS-1.45-T1
1.5V	SC70JW-8	JGXYY	AAT3238IJS-1.5-T1
1.8V	SC70JW-8	JRXYY	AAT3238IJS-1.8-T1
2.0V	SC70JW-8		AAT3238IJS-2.0-T1
2.3V	SC70JW-8		AAT3238IJS-2.3-T1
2.5V	SC70JW-8	KUXYY	AAT3238IJS-2.5-T1
2.7V	SC70JW-8		AAT3238IJS-2.7-T1
2.8V	SC70JW-8	FCXYY	AAT3238IJS-2.8-T1
2.85	SC70JW-8		AAT3238IJS-2.85-T1
3.0V	SC70JW-8		AAT3238IJS-3.0-T1
3.3V	SC70JW-8		AAT3238IJS-3.3-T1
3.5V	SC70JW-8		AAT3238IJS-3.5-T1

Note: Sample stock is generally held on all part numbers listed in **BOLD**.

Note 1: XYY = assembly and date code.

Package Information

SOT23-6

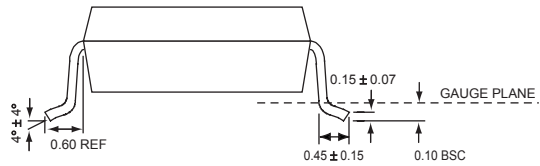
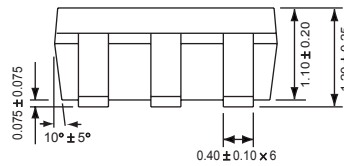
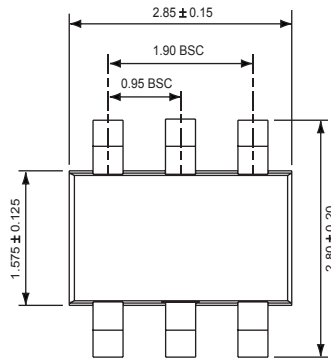

All dimensions in millimeters.

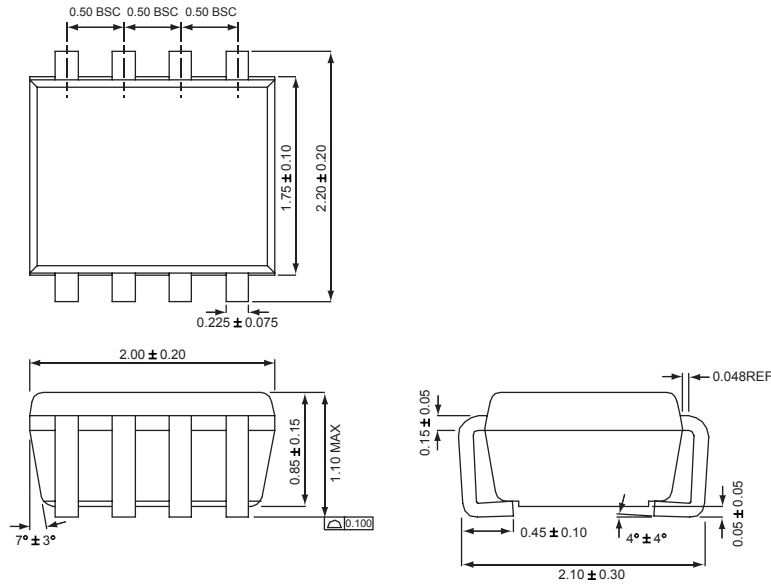
SC70JW-8

All dimensions in millimeters.

AnalogicTech cannot assume responsibility for use of any circuitry other than circuitry entirely embodied in an AnalogicTech product. No circuit patent licenses, copyrights, mask work rights, or other intellectual property rights are implied.

AnalogicTech reserves the right to make changes to their products or specifications or to discontinue any product or service without notice, and advise customers to obtain the latest version of relevant information to verify, before placing orders, that information being relied on is current and complete. All products are sold subject to the terms and conditions of sale supplied at the time of order acknowledgement, including those pertaining to warranty, patent infringement, and limitation of liability.

AnalogicTech warrants performance of its semiconductor products to the specifications applicable at the time of sale in accordance with AnalogicTech's standard warranty. Testing and other quality control techniques are utilized to the extent AnalogicTech deems necessary to support this warranty. Specific testing of all parameters of each device is not necessarily performed.