

[查询FS30SM供应商](#)

捷多邦, 专业PCB打样工厂, 24小时加急出货

MITSUBISHI Nch POWER MOSFET

FS30SM-03

HIGH-SPEED SWITCHING USE

FS30SM-03

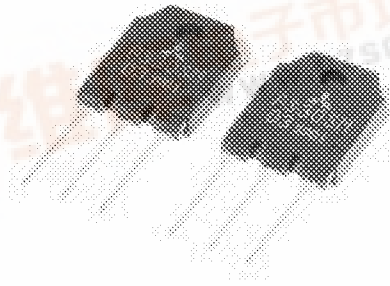

- 10V DRIVE
- V_{DSS} 30V
- r_{DS (ON)} (MAX) 46mΩ
- I_D 30A
- Integrated Fast Recovery Diode (TYP.) 45ns

OUTLINE DRAWING

Dimensions in mm

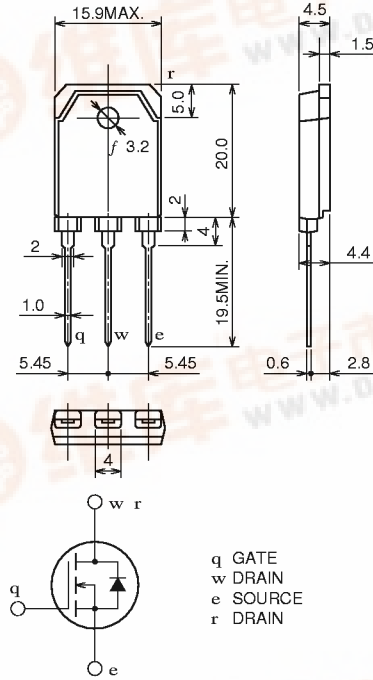

APPLICATION

Motor control, Lamp control, Solenoid control
DC-DC converter, etc.

MAXIMUM RATINGS (T_c = 25°C)

Symbol	Parameter	Conditions	Ratings	Unit
V _{DSS}	Drain-source voltage	V _{GS} = 0V	30	V
V _{GSS}	Gate-source voltage	V _{DS} = 0V	±20	V
I _D	Drain current		30	A
I _{DM}	Drain current (Pulsed)		120	A
I _{DA}	Avalanche drain current (Pulsed)	L = 30μH	30	A
I _S	Source current		30	A
I _{SM}	Source current (Pulsed)		120	A
P _D	Maximum power dissipation		30	W
T _{ch}	Channel temperature		-55 ~ +150	°C
T _{stg}	Storage temperature		-55 ~ +150	°C
	Weight	Typical value	4.8	g

FS30SM-03

HIGH-SPEED SWITCHING USE

ELECTRICAL CHARACTERISTICS (T_{ch} = 25°C)

Symbol	Parameter	Test conditions	Limits			Unit
			Min.	Typ.	Max.	
V _{(BR)DSS}	Drain-source breakdown voltage	I _D = 1mA, V _{GS} = 0V	30	—	—	V
I _{GSS}	Gate-source leakage current	V _{GS} = ±20V, V _{DS} = 0V	—	—	±0.1	μA
I _{DSS}	Drain-source leakage current	V _{DS} = 30V, V _{GS} = 0V	—	—	0.1	mA
V _{GS(th)}	Gate-source threshold voltage	I _D = 1mA, V _{DS} = 10V	2.0	3.0	4.0	V
r _{DS(ON)}	Drain-source on-state resistance	I _D = 15A, V _{GS} = 10V	—	36	46	mΩ
V _{DS(ON)}	Drain-source on-state voltage	I _D = 15A, V _{GS} = 10V	—	0.54	0.69	V
y _{fs}	Forward transfer admittance	I _D = 15A, V _{DS} = 5V	—	11	—	S
C _{iss}	Input capacitance	V _{DS} = 10V, V _{GS} = 0V, f = 1MHz	—	600	—	pF
C _{oss}	Output capacitance		—	250	—	pF
C _{rss}	Reverse transfer capacitance		—	110	—	pF
t _{d(on)}	Turn-on delay time		—	18	—	ns
t _r	Rise time	V _{DD} = 15V, I _D = 15A, V _{GS} = 10V, R _{GEN} = R _{GS} = 50Ω	—	65	—	ns
t _{d(off)}	Turn-off delay time		—	30	—	ns
t _f	Fall time		—	25	—	ns
V _{SD}	Source-drain voltage		I _S = 15A, V _{GS} = 0V	—	1.0	1.5
R _{th(ch-c)}	Thermal resistance	Channel to case	—	—	4.17	°C/W
t _{rr}	Reverse recovery time	I _S = 15A, dis/dt = -50A/μs	—	45	—	ns

PERFORMANCE CURVES

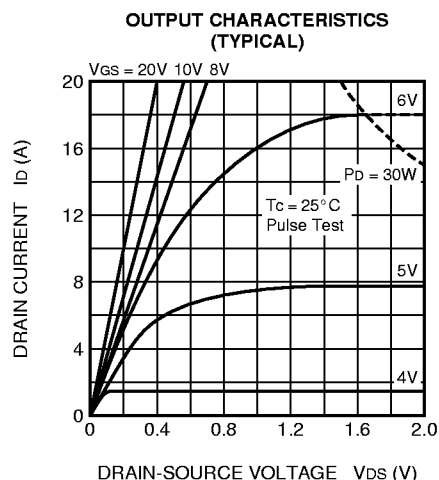
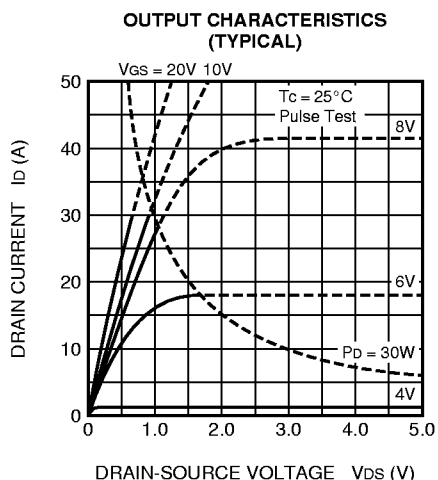
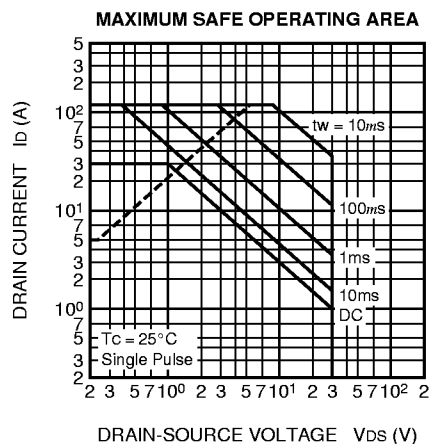
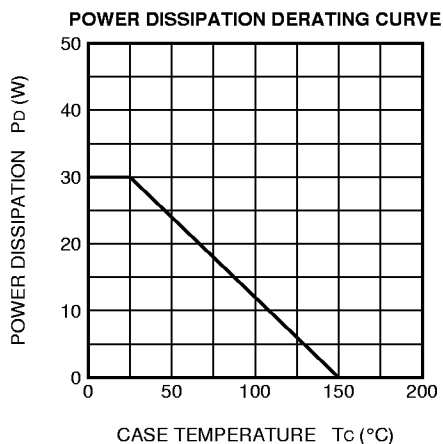

ON-STATE VOLTAGE VS. GATE-SOURCE VOLTAGE (TYPICAL)

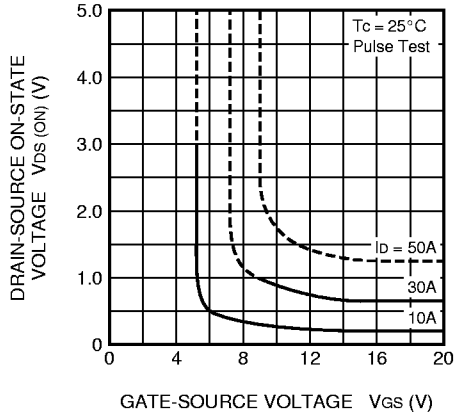

ON-STATE RESISTANCE VS. DRAIN CURRENT (TYPICAL)

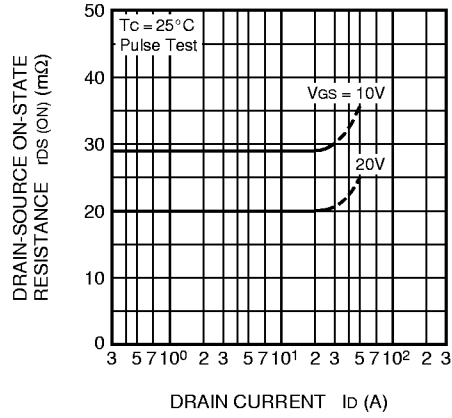

TRANSFER CHARACTERISTICS (TYPICAL)

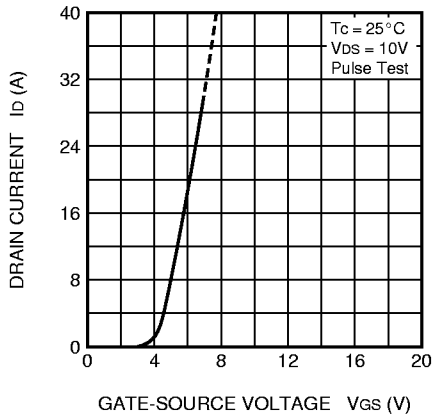

FORWARD TRANSFER ADMITTANCE VS. DRAIN CURRENT (TYPICAL)

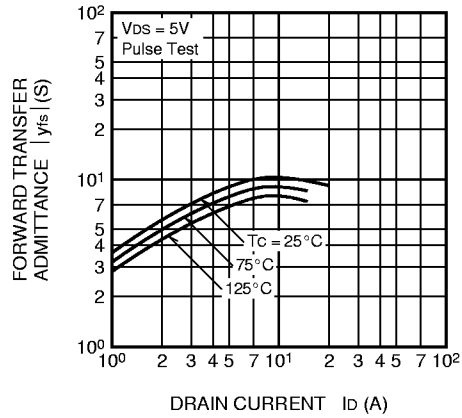

CAPACITANCE VS. DRAIN-SOURCE VOLTAGE (TYPICAL)

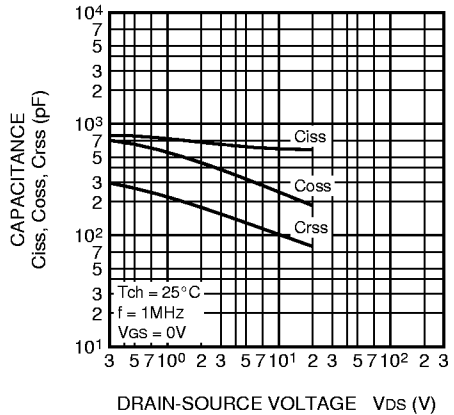

SWITCHING CHARACTERISTICS (TYPICAL)

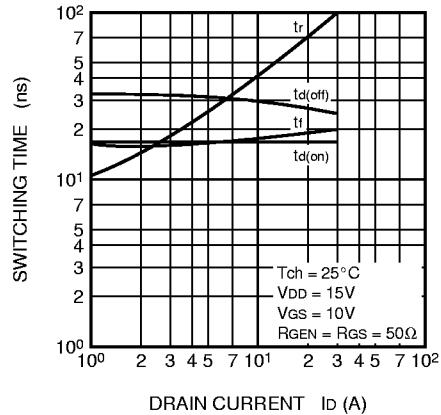

FS30SM-03

HIGH-SPEED SWITCHING USE

GATE-SOURCE VOLTAGE VS. GATE CHARGE (TYPICAL)

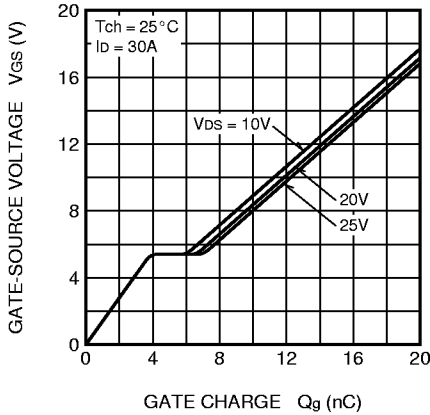

SOURCE-DRAIN DIODE FORWARD CHARACTERISTICS (TYPICAL)

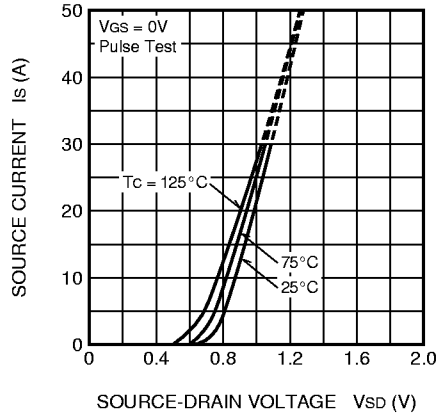

ON-STATE RESISTANCE VS. CHANNEL TEMPERATURE (TYPICAL)

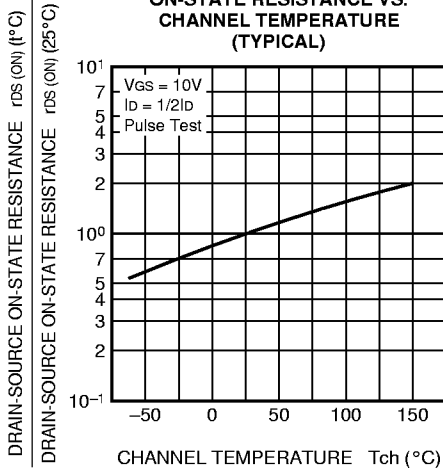

THRESHOLD VOLTAGE VS. CHANNEL TEMPERATURE (TYPICAL)

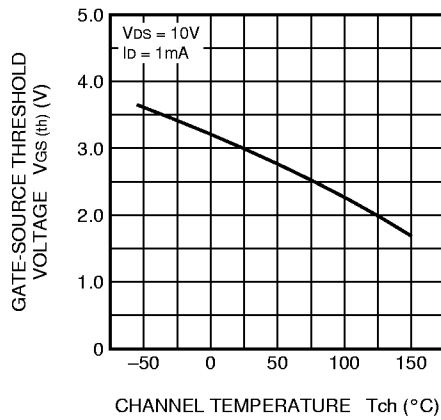

BREAKDOWN VOLTAGE VS. CHANNEL TEMPERATURE (TYPICAL)

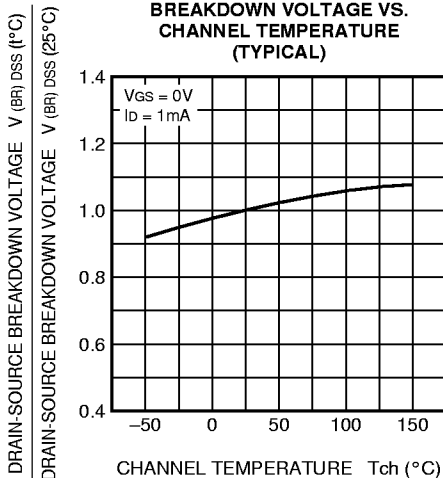

TRANSIENT THERMAL IMPEDANCE CHARACTERISTICS

