



April 1998

## LM2931 Series Low Dropout Regulators

### General Description

The LM2931 positive voltage regulator features a very low quiescent current of 1 mA or less when supplying 10 mA loads. This unique characteristic and the extremely low input-output differential required for proper regulation (0.2V for output currents of 10 mA) make the LM2931 the ideal regulator for standby power systems. Applications include memory standby circuits, CMOS and other low power processor power supplies as well as systems demanding as much as 100 mA of output current.

Designed originally for automotive applications, the LM2931 and all regulated circuitry are protected from reverse battery installations or 2 battery jumps. During line transients, such as a load dump (60V) when the input voltage to the regulator can momentarily exceed the specified maximum operating voltage, the regulator will automatically shut down to protect both internal circuits and the load. The LM2931 cannot be harmed by temporary mirror-image insertion. Familiar regulator features such as short circuit and thermal overload protection are also provided.

The LM2931 family includes a fixed 5V output ( $\pm 3.8\%$  tolerance for A grade) or an adjustable output with ON/OFF pin. Both versions are available in a TO-220 power package, TO-263 surface mount package, and an 8-lead surface mount package. The fixed output version is also available in the TO-92 plastic package.

### Features

- Very low quiescent current
- Output current in excess of 100 mA
- Input-output differential less than 0.6V
- Reverse battery protection
- 60V load dump protection
- -50V reverse transient protection
- Short circuit protection
- Internal thermal overload protection
- Mirror-image insertion protection
- Available in TO-220, TO-92, TO-263 or SO-8 packages
- Available as adjustable with TTL compatible switch

### Output Voltage Options

Output Number	Part Number	Package Type
5V	LM2931T-5.0, LM2931AT-5.0	3-Lead TO-220
	LM2931S-5.0, LM2931AS-5.0	3-Lead TO-263
	LM2931Z-5.0, LM2931AZ-5.0	TO-92
	LM2931M-5.0, LM2931AM-5.0	8-Lead SO
Adjustable, 3V to 24V	LM2931CT	5-Lead TO-220
	LM2931CS	5-Lead TO-263
	LM2931CM	8-Lead SO

### Typical Applications

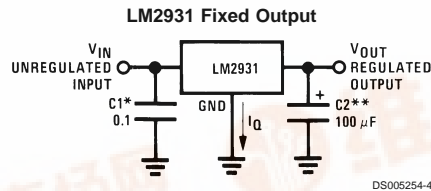

\*Required if regulator is located far from power supply filter.

\*\*C2 must be at least 100  $\mu\text{F}$  to maintain stability. May be increased without bound to maintain regulation during transients. Locate as close as possible to the regulator. This capacitor must be rated over the same operating temperature range as the regulator. The equivalent series resistance (ESR) of this capacitor is critical; see curve.

LM2931 Series Low Dropout Regulators



## Typical Applications (Continued)

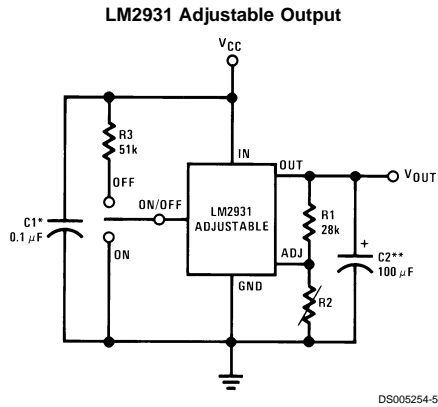

$$V_{OUT} = \text{Reference Voltage} \times \frac{R1 + R2}{R1}$$

**Note:** Using 27k for R1 will automatically compensate for errors in  $V_{OUT}$  due to the input bias current of the ADJ pin (approximately 1  $\mu$ A).

## Connection Diagrams and Ordering Information

### FIXED 5V OUTPUT

#### TO-220 3-Lead Power Package

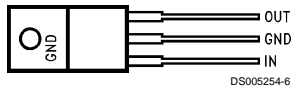

#### Front View

Order Number LM2931T-5.0 or LM2931AT-5.0  
See NS Package Number T03B

#### TO-263 Surface-Mount Package

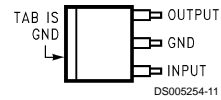

#### Top View



#### Side View

Order Number LM2931S-5.0 or LM2931AS-5.0  
See NS Package Number TS3B

#### 8-Pin Surface Mount

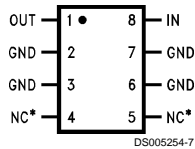

#### Top View

Order Number LM2931M-5.0 or LM2931AM-5.0  
See NS Package Number M08A

#### TO-92 Plastic Package

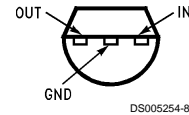

#### Bottom View

Order Number LM2931Z-5.0 or LM2931AZ-5.0  
See NS Package Number Z03A

\*NC = Not internally connected

## Connection Diagrams and Ordering Information (Continued)

### ADJUSTABLE OUTPUT VOLTAGE

#### TO-220 5-Lead Power Package

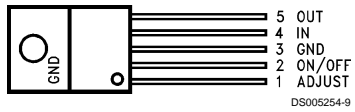

**Front View**  
Order Number LM2931CT  
See NS Package Number T05A

#### TO-263 5-Lead Surface-Mount Package

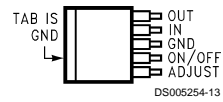

**Top View**



**Side View**

Order Number LM2931CS  
See NS Package Number TS5B

#### 8-Pin Surface Mount

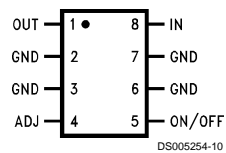

**Top View**  
Order Number LM2931CM  
See NS Package Number M08A

## Absolute Maximum Ratings (Note 1)

If Military/Aerospace specified devices are required, please contact the National Semiconductor Sales Office/Distributors for availability and specifications.

Input Voltage	
Operating Range	26V
Overvoltage Protection	
LM2931A, LM2931C (Adjustable)	60V
LM2931	50V

## Internal Power Dissipation

(Note 2) (Note 4)	Internally Limited
Operating Ambient Temperature Range	-40°C to +85°C
Maximum Junction Temperature	125°C
Storage Temperature Range	-65°C to +150°C
Lead Temp. (Soldering, 10 seconds)	230°C
ESD Tolerance (Note 5)	2000V

## Electrical Characteristics for Fixed 5V Version

$V_{IN} = 14V$ ,  $I_O = 10\text{ mA}$ ,  $T_J = 25^\circ\text{C}$ ,  $C_2 = 100\ \mu\text{F}$  (unless otherwise specified) (Note 2)

Parameter	Conditions	LM2931A-5.0		LM2931-5.0		Units Limit
		Typ	Limit (Note 3)	Typ	Limit (Note 3)	
Output Voltage		5	5.19 4.81		5.25 4.75	$V_{MAX}$ $V_{MIN}$
	$6.0V \leq V_{IN} \leq 26V$ , $I_O = 100\text{ mA}$ $-40^\circ\text{C} \leq T_J \leq 125^\circ\text{C}$		<b>5.25</b> <b>4.75</b>		<b>5.5</b> <b>4.5</b>	$V_{MAX}$ $V_{MIN}$
Line Regulation	$9V \leq V_{IN} \leq 16V$	2	10	2	10	$mV_{MAX}$
	$6V \leq V_{IN} \leq 26V$	4	30	4	30	$mV_{MAX}$
Load Regulation	$5\text{ mA} \leq I_O \leq 100\text{ mA}$	14	50	14	50	$mV_{MAX}$
Output Impedance	$100\text{ mA}_{DC}$ and $10\text{ mA}_{RMS}$ , 100 Hz–10 kHz	200		200		$m\Omega_{MAX}$
Quiescent Current	$I_O \leq 10\text{ mA}$ , $6V \leq V_{IN} \leq 26V$ $-40^\circ\text{C} \leq T_J \leq 125^\circ\text{C}$	0.4	<b>1.0</b>	0.4	<b>1.0</b>	$\text{mA}_{MAX}$
	$I_O = 100\text{ mA}$ , $V_{IN} = 14V$ , $T_J = 25^\circ\text{C}$	15	30 5	15		$\text{mA}_{MAX}$ $\text{mA}_{MIN}$
Output Noise Voltage	10 Hz–100 kHz, $C_{OUT} = 100\ \mu\text{F}$	500		500		$\mu V_{RMSMAX}$
Long Term Stability		20		20		$\text{mV}/1000\text{ hr}$
Ripple Rejection	$f_O = 120\text{ Hz}$	80	<b>55</b>	80		$\text{dB}_{MIN}$
Dropout Voltage	$I_O = 10\text{ mA}$	0.05	0.2	0.05	0.2	$V_{MAX}$
	$I_O = 100\text{ mA}$	0.3	0.6	0.3	0.6	$V_{MAX}$
Maximum Operational Input Voltage		33		33		$V_{MAX}$
			26		26	$V_{MIN}$
Maximum Line Transient	$R_L = 500\Omega$ , $V_O \leq 5.5V$ , $T = 1\text{ ms}$ , $\tau \leq 100\text{ ms}$	70	60	70	50	$V_{MIN}$
Reverse Polarity Input Voltage, DC	$V_O \geq -0.3V$ , $R_L = 500\Omega$	-30	-15	-30	-15	$V_{MIN}$
Reverse Polarity Input Voltage, Transient	$T = 1\text{ ms}$ , $\tau \leq 100\text{ ms}$ , $R_L = 500\Omega$	-80	-50	-80	-50	$V_{MIN}$

**Note 1:** Absolute Maximum Ratings indicate limits beyond which damage to the device may occur. Electrical specifications do not apply when operating the device beyond its rated operating conditions.

**Note 2:** See circuit in Typical Applications. To ensure constant junction temperature, low duty cycle pulse testing is used.

**Note 3:** All limits are guaranteed for  $T_J = 25^\circ\text{C}$  (standard type face) or over the full operating junction temperature range of  $-40^\circ\text{C}$  to  $+125^\circ\text{C}$  (bold type face).

**Note 4:** The maximum power dissipation is a function of maximum junction temperature  $T_{Jmax}$ , total thermal resistance  $\theta_{JA}$ , and ambient temperature  $T_A$ . The maximum allowable power dissipation at any ambient temperature is  $P_D = (T_{Jmax} - T_A)/\theta_{JA}$ . If this dissipation is exceeded, the die temperature will rise above  $150^\circ\text{C}$  and the LM2931 will go into thermal shutdown. For the LM2931 in the TO-92 package,  $\theta_{JA}$  is  $195^\circ\text{C}/\text{W}$ ; in the SO-8 package,  $\theta_{JA}$  is  $160^\circ\text{C}/\text{W}$ , and in the TO-220 package,  $\theta_{JA}$  is  $50^\circ\text{C}/\text{W}$ ; and in the TO-263 package,  $\theta_{JA}$  is  $73^\circ\text{C}/\text{W}$ . If the TO-220 package is used with a heat sink,  $\theta_{JA}$  is the sum of the package thermal resistance junction-to-case of  $3^\circ\text{C}/\text{W}$  and the thermal resistance added by the heat sink and thermal interface.

If the TO-263 package is used, the thermal resistance can be reduced by increasing the P.C. board copper area thermally connected to the package: Using 0.5 square inches of copper area,  $\theta_{JA}$  is  $50^\circ\text{C}/\text{W}$ ; with 1 square inch of copper area,  $\theta_{JA}$  is  $37^\circ\text{C}/\text{W}$ ; and with 1.6 or more square inches of copper area,  $\theta_{JA}$  is  $32^\circ\text{C}/\text{W}$ .

**Note 5:** Human body model, 100 pF discharged through 1.5 k $\Omega$ .

## Electrical Characteristics for Adjustable Version

$V_{IN} = 14V$ ,  $V_{OUT} = 3V$ ,  $I_O = 10\text{ mA}$ ,  $T_J = 25^\circ\text{C}$ ,  $R_1 = 27k$ ,  $C_2 = 100\ \mu\text{F}$  (unless otherwise specified) (Note 2)

Parameter	Conditions	Typ	Limit	Units Limit
Reference Voltage		1.20	1.26 1.14	$V_{MAX}$ $V_{MIN}$
	$I_O \leq 100\text{ mA}$ , $-40^\circ\text{C} \leq T_J \leq 125^\circ\text{C}$ , $R_1 = 27k$ Measured from $V_{OUT}$ to Adjust Pin		<b>1.32</b> <b>1.08</b>	$V_{MAX}$ $V_{MIN}$
Output Voltage Range			24 3	$V_{MAX}$ $V_{MIN}$
Line Regulation	$V_{OUT} + 0.6V \leq V_{IN} \leq 26V$	0.2	1.5	$\text{mV}/V_{MAX}$
Load Regulation	$5\text{ mA} \leq I_O \leq 100\text{ mA}$	0.3	1	$\%_{MAX}$
Output Impedance	$100\text{ mA}_{DC}$ and $10\text{ mA}_{rms}$ , 100 Hz–10 kHz	40		$\text{m}\Omega/V$
Quiescent Current	$I_O = 10\text{ mA}$	0.4	1	$\text{mA}_{MAX}$
	$I_O = 100\text{ mA}$	15		$\text{mA}$
	During Shutdown $R_L = 500\Omega$	0.8	1	$\text{mA}_{MAX}$
Output Noise Voltage	10 Hz–100 kHz	100		$\mu\text{V}_{rms}/V$
Long Term Stability		0.4		$\%/1000\text{ hr}$
Ripple Rejection	$f_O = 120\text{ Hz}$	0.02		$\%/V$
Dropout Voltage	$I_O \leq 10\text{ mA}$	0.05	0.2	$V_{MAX}$
	$I_O = 100\text{ mA}$	0.3	0.6	$V_{MAX}$
Maximum Operational Input Voltage		33	26	$V_{MIN}$
Maximum Line Transient	$I_O = 10\text{ mA}$ , Reference Voltage $\leq 1.5V$ $T = 1\text{ ms}$ , $\tau \leq 100\text{ ms}$	70	60	$V_{MIN}$
Reverse Polarity Input Voltage, DC	$V_O \geq -0.3V$ , $R_L = 500\Omega$	-30	-15	$V_{MIN}$
Reverse Polarity Input Voltage, Transient	$T = 1\text{ ms}$ , $\tau \leq 100\text{ ms}$ , $R_L = 500\Omega$	-80	-50	$V_{MIN}$
On/Off Threshold Voltage	$V_O = 3V$			
	On	2.0	1.2	$V_{MAX}$
Off	2.2	3.25	$V_{MIN}$	
On/Off Threshold Current		20	50	$\mu\text{A}_{MAX}$

## Typical Performance Characteristics

Dropout Voltage

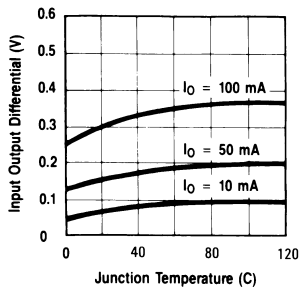

Dropout Voltage

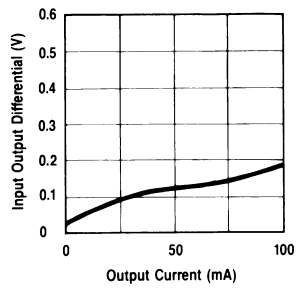

Low Voltage Behavior

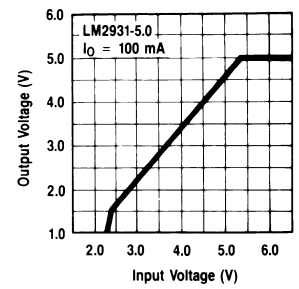

## Typical Performance Characteristics (Continued)

Output at Voltage Extremes

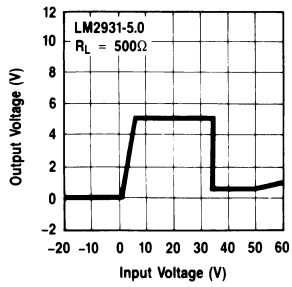

DS005254-19

Line Transient Response

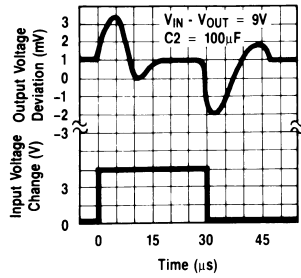

DS005254-20

Load Transient Response

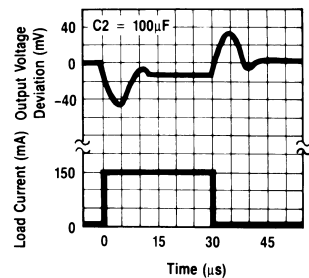

DS005254-21

Peak Output Current

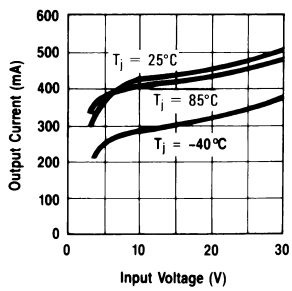

DS005254-22

Quiescent Current

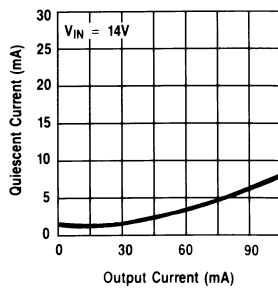

DS005254-23

Quiescent Current

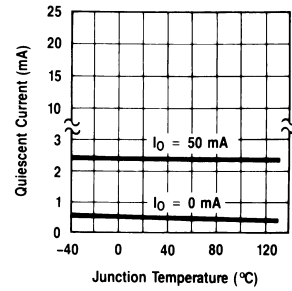

DS005254-24

Quiescent Current

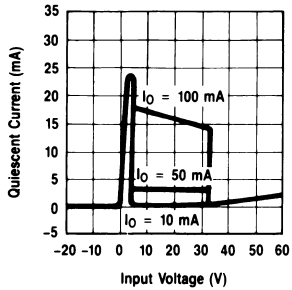

DS005254-25

Ripple Rejection

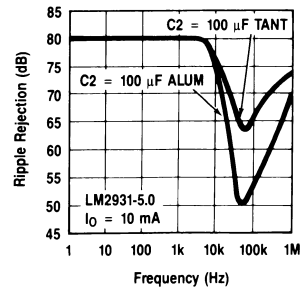

DS005254-26

Ripple Rejection

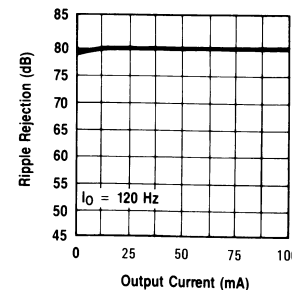

DS005254-27

## Typical Performance Characteristics (Continued)

**Output Impedance**

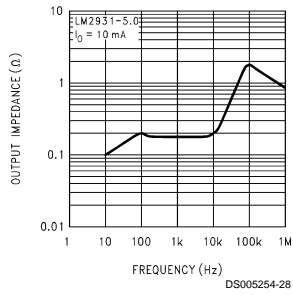

**Operation During Load Dump**

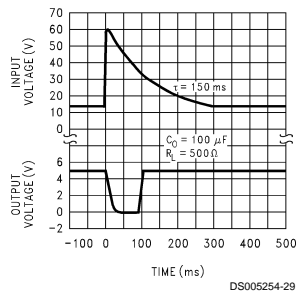

**Reference Voltage**

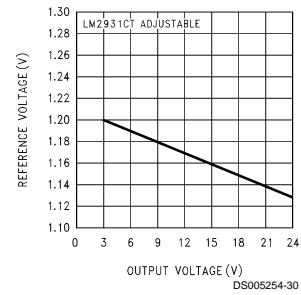

**Maximum Power Dissipation (SO-8)**

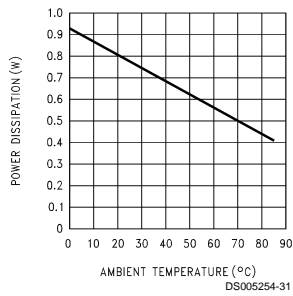

**Maximum Power Dissipation (TO-220)**

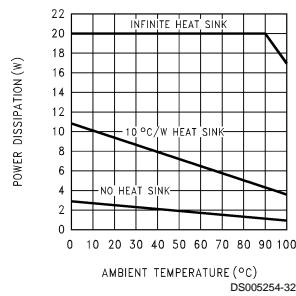

**Maximum Power Dissipation (TO-92)**

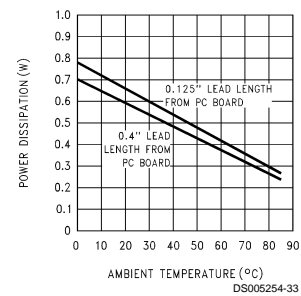

**Maximum Power Dissipation (TO-263) (Note 4)**

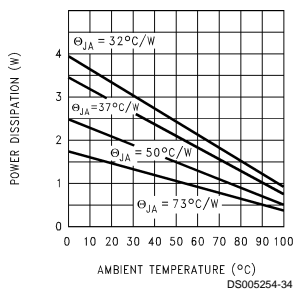

**On/Off Threshold**

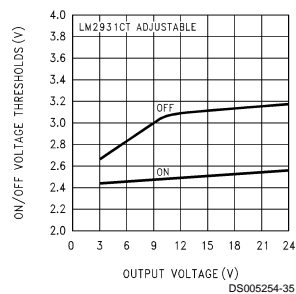

**Output Capacitor ESR**

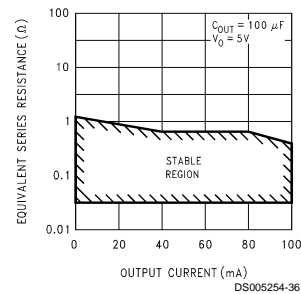

## Schematic Diagram

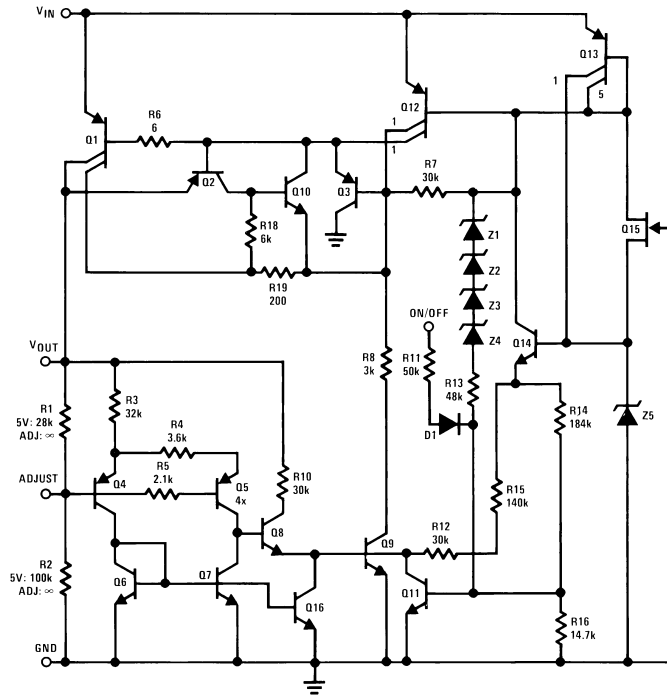

DS005254-1

## Application Hints

One of the distinguishing factors of the LM2931 series regulators is the requirement of an output capacitor for device stability. The value required varies greatly depending upon the application circuit and other factors. Thus some comments on the characteristics of both capacitors and the regulator are in order.

High frequency characteristics of electrolytic capacitors depend greatly on the type and even the manufacturer. As a result, a value of capacitance that works well with the LM2931 for one brand or type may not necessarily be sufficient with an electrolytic of different origin. Sometimes actual bench testing, as described later, will be the only means to determine the proper capacitor type and value. Experience has shown that, as a rule of thumb, the more expensive and higher quality electrolytics generally allow a smaller value for regulator stability. As an example, while a high-quality 100  $\mu\text{F}$  aluminum electrolytic covers all general application circuits, similar stability can be obtained with a tantalum electrolytic of only 47  $\mu\text{F}$ . This factor of two can generally be applied to any special application circuit also.

Another critical characteristic of electrolytics is their performance over temperature. While the LM2931 is designed to operate to  $-40^\circ\text{C}$ , the same is not always true with all electrolytics (hot is generally not a problem). The electrolyte in many aluminum types will freeze around  $-30^\circ\text{C}$ , reducing their effective value to zero. Since the capacitance is needed for regulator stability, the natural result is oscillation (and lots of it) at the regulator output. For all application circuits where cold operation is necessary, the output capacitor must be rated to operate at the minimum temperature. By coinci-

dence, worst-case stability for the LM2931 also occurs at minimum temperatures. As a result, in applications where the regulator junction temperature will never be less than  $25^\circ\text{C}$ , the output capacitor can be reduced approximately by a factor of two over the value needed for the entire temperature range. To continue our example with the tantalum electrolytic, a value of only 22  $\mu\text{F}$  would probably thus suffice. For high-quality aluminum, 47  $\mu\text{F}$  would be adequate in such an application.

Another regulator characteristic that is noteworthy is that stability decreases with higher output currents. This sensible fact has important connotations. In many applications, the LM2931 is operated at only a few milliamps of output current or less. In such a circuit, the output capacitor can be further reduced in value. As a rough estimation, a circuit that is required to deliver a maximum of 10 mA of output current from the regulator would need an output capacitor of only half the value compared to the same regulator required to deliver the full output current of 100 mA. If the example of the tantalum capacitor in the circuit rated at  $25^\circ\text{C}$  junction temperature and above were continued to include a maximum of 10 mA of output current, then the 22  $\mu\text{F}$  output capacitor could be reduced to only 10  $\mu\text{F}$ .

In the case of the LM2931CT adjustable regulator, the minimum value of output capacitance is a function of the output voltage. As a general rule, the value decreases with higher output voltages, since internal loop gain is reduced.

At this point, the procedure for bench testing the minimum value of an output capacitor in a special application circuit should be clear. Since worst-case occurs at minimum oper-



## Application Hints (Continued)

ating temperatures and maximum operating currents, the entire circuit, including the electrolytic, should be cooled to the minimum temperature. The input voltage to the regulator should be maintained at 0.6V above the output to keep internal power dissipation and die heating to a minimum. Worst-case occurs just after input power is applied and before the die has had a chance to heat up. Once the minimum value of capacitance has been found for the brand and type of electrolytic in question, the value should be doubled for actual use to account for production variations both in the capacitor and the regulator. (All the values in this section and the remainder of the data sheet were determined in this fashion.)

## Definition of Terms

**Dropout Voltage:** The input-output voltage differential at which the circuit ceases to regulate against further reduction in input voltage. Measured when the output voltage has dropped 100 mV from the nominal value obtained at 14V input, dropout voltage is dependent upon load current and junction temperature.

**Input Voltage:** The DC voltage applied to the input terminals with respect to ground.

**Input-Output Differential:** The voltage difference between the unregulated input voltage and the regulated output voltage for which the regulator will operate.

**Line Regulation:** The change in output voltage for a change in the input voltage. The measurement is made under conditions of low dissipation or by using pulse techniques such that the average chip temperature is not significantly affected.

**Load Regulation:** The change in output voltage for a change in load current at constant chip temperature.

**Long Term Stability:** Output voltage stability under accelerated life-test conditions after 1000 hours with maximum rated voltage and junction temperature.

**Output Noise Voltage:** The rms AC voltage at the output, with constant load and no input ripple, measured over a specified frequency range.

**Quiescent Current:** That part of the positive input current that does not contribute to the positive load current. The regulator ground lead current.

**Ripple Rejection:** The ratio of the peak-to-peak input ripple voltage to the peak-to-peak output ripple voltage at a specified frequency.

**Temperature Stability of  $V_O$ :** The percentage change in output voltage for a thermal variation from room temperature to either temperature extreme.

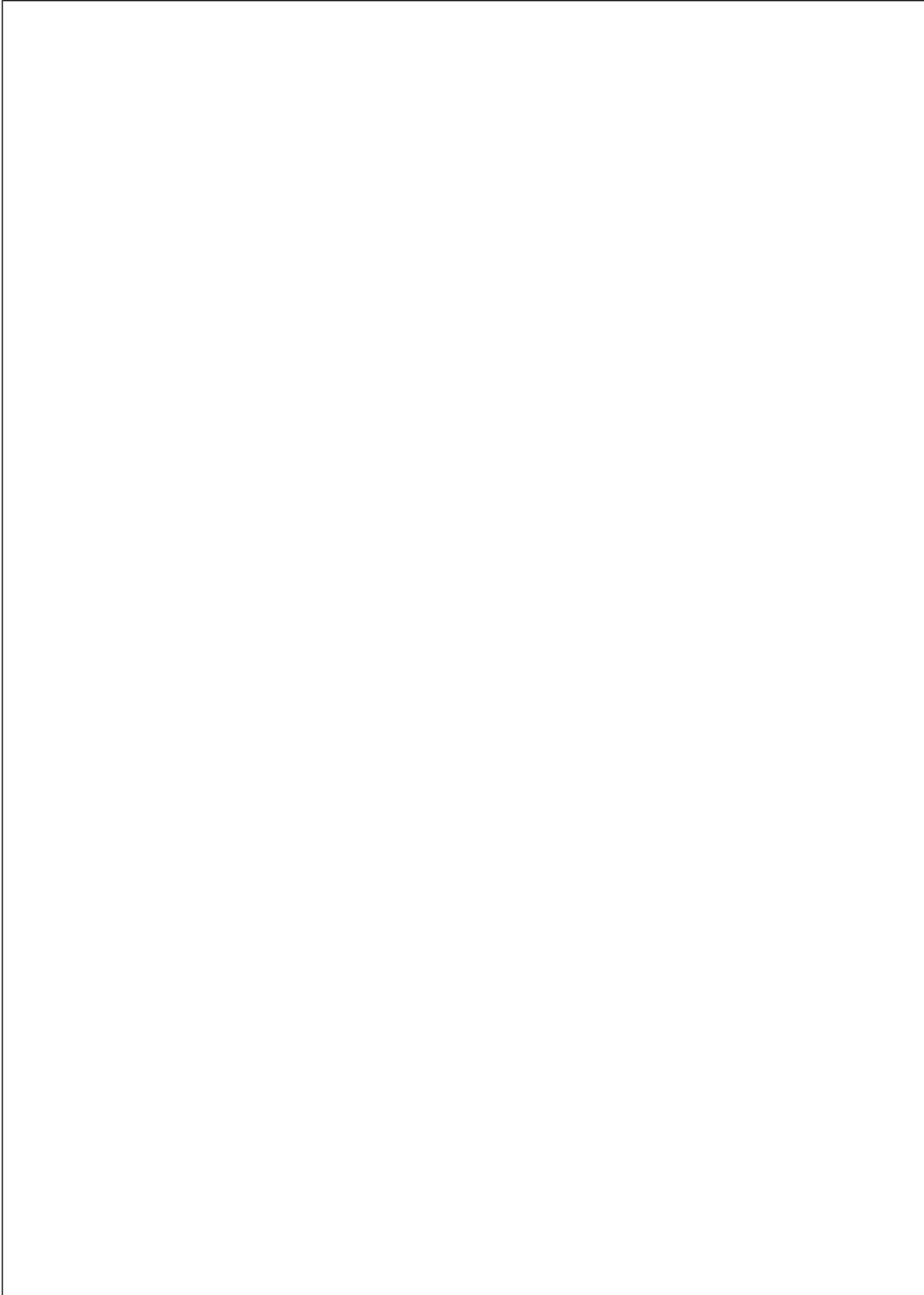

**Physical Dimensions** inches (millimeters) unless otherwise noted

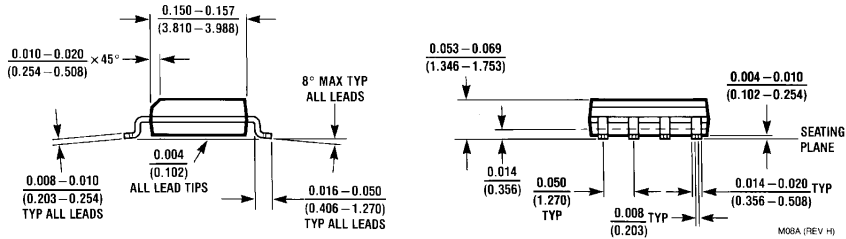
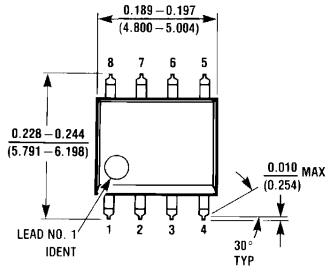

**8-Lead Surface Mount Package (M)**  
 Order Number LM2931AM-5.0, LM2931M-5.0 or LM2931CM  
 NS Package Number M08A

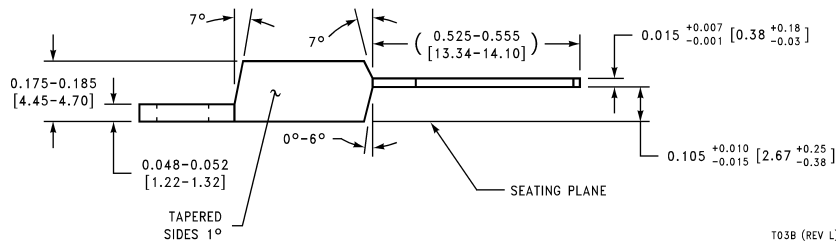
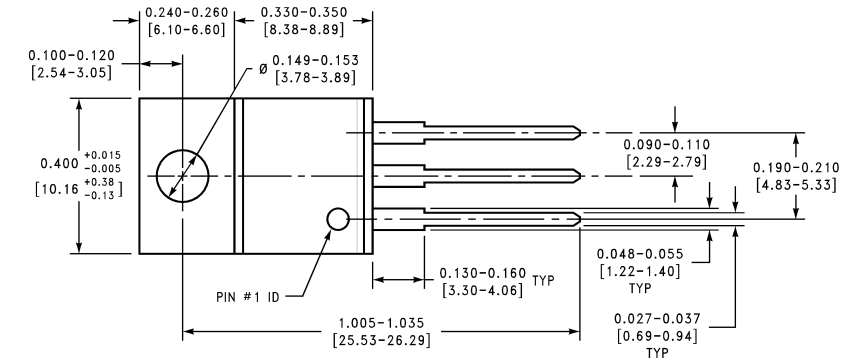

**3-Lead TO-220 Plastic Package (T)**  
 Order Number LM2931AT-5.0 or LM2931T-5.0  
 NS Package Number T03B

**Physical Dimensions** inches (millimeters) unless otherwise noted (Continued)

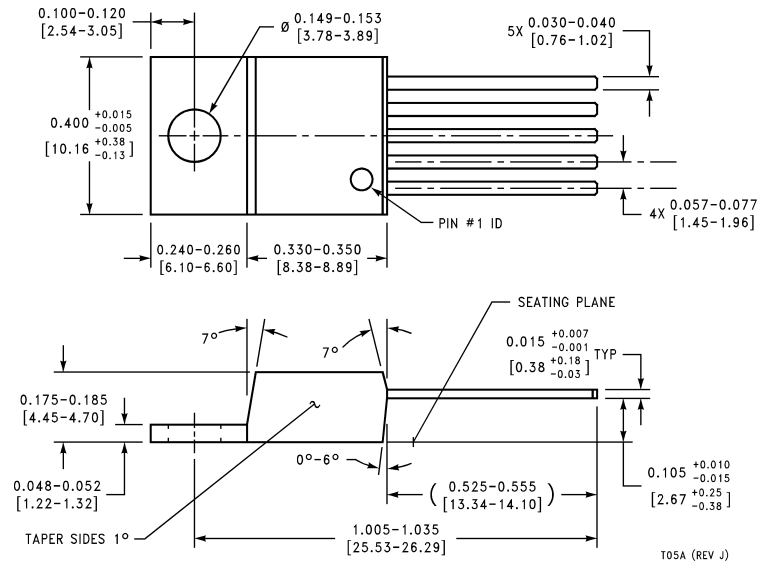

**5-Lead TO-220 Power Package (T)**  
 Order Number LM2931CT  
 NS Package Number T05A

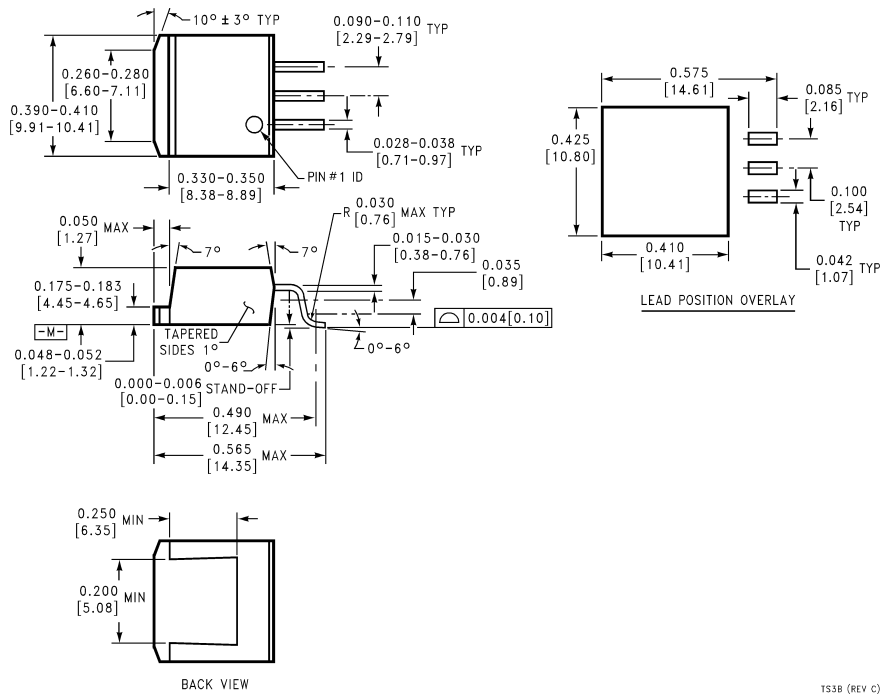

**3-Lead TO-263 Surface Mount Package**  
 Order Number LM2931S-5.0 or LM2931AS-5.0  
 NS Package Number TS3B

**Physical Dimensions** inches (millimeters) unless otherwise noted (Continued)

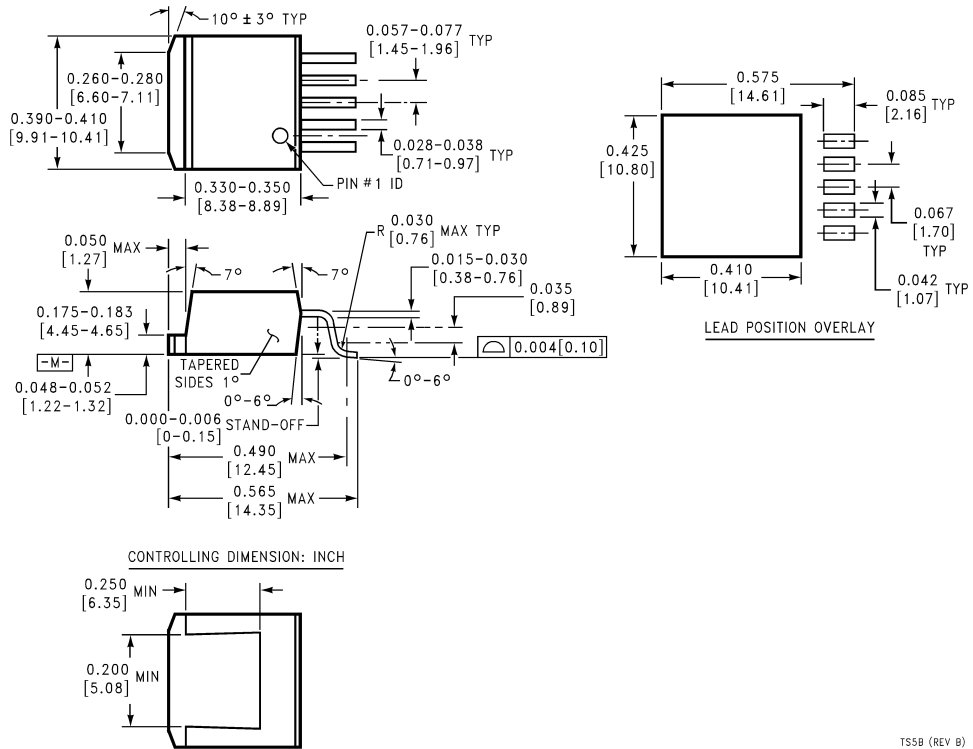

**5-Lead TO-263 Surface Mount Package**  
**Order Number LM2931CS**  
**NS Package Number TS5B**

TS5B (REV B)

**Physical Dimensions** inches (millimeters) unless otherwise noted (Continued)

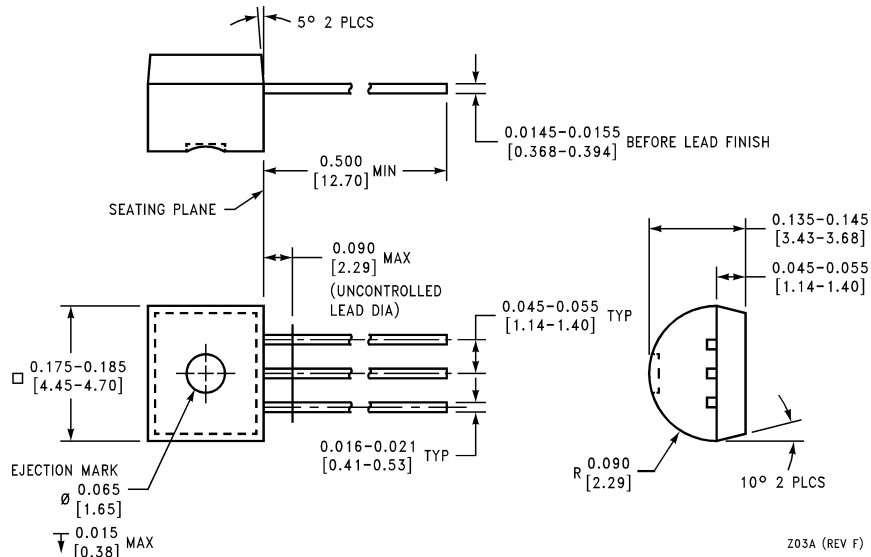

Z03A (REV F)

**3-Lead TO-92 Plastic Package (Z)**  
**Order Number LM2931AZ-5.0 or LM2931Z-5.0**  
**NS Package Number Z03A**

**LIFE SUPPORT POLICY**

NATIONAL'S PRODUCTS ARE NOT AUTHORIZED FOR USE AS CRITICAL COMPONENTS IN LIFE SUPPORT DEVICES OR SYSTEMS WITHOUT THE EXPRESS WRITTEN APPROVAL OF THE PRESIDENT OF NATIONAL SEMICONDUCTOR CORPORATION. As used herein:

1. Life support devices or systems are devices or systems which, (a) are intended for surgical implant into the body, or (b) support or sustain life, and whose failure to perform when properly used in accordance with instructions for use provided in the labeling, can be reasonably expected to result in a significant injury to the user.
2. A critical component in any component of a life support device or system whose failure to perform can be reasonably expected to cause the failure of the life support device or system, or to affect its safety or effectiveness.

 <p><b>National Semiconductor Corporation</b>  Americas  Tel: 1-800-272-9959  Fax: 1-800-737-7018  Email: support@nsc.com</p> <p>www.national.com</p>	<p><b>National Semiconductor Europe</b></p> <p>Fax: +49 (0) 1 80-530 85 86  Email: europe.support@nsc.com</p> <p>Deutsch Tel: +49 (0) 1 80-530 85 85  English Tel: +49 (0) 1 80-532 78 32  Français Tel: +49 (0) 1 80-532 93 58  Italiano Tel: +49 (0) 1 80-534 16 80</p>	<p><b>National Semiconductor Asia Pacific Customer Response Group</b></p> <p>Tel: 65-2544466  Fax: 65-2504466  Email: sea.support@nsc.com</p>	<p><b>National Semiconductor Japan Ltd.</b></p> <p>Tel: 81-3-5620-6175  Fax: 81-3-5620-6179</p>
--	---	---	---