



Octal, RS-232/RS-423 Line Receiver

ADM5180

FEATURES

Eight Differential Line Receivers in One Package
Meets EIA Standard EIA-232E, 423A, 422A and
CCITT V.10, V.11, V.28

Single +5 V Supply
Differential Inputs Withstand ± 25 V
Internal Hysteresis
Low Power CMOS -3.5 mA Supply Current
TTL/CMOS Compatible Outputs
Available in 28-Pin DIP and PLCC Packages
Low Power Replacement for UC5180C/NE5180

APPLICATIONS

High Speed Communication
Computer I-O Ports
Peripherals
High Speed Modems
Printers
Logic Level Translation

GENERAL DESCRIPTION

The ADM5180 is an octal differential line receiver suitable for a wide range of digital communication systems with data rates up to 200 kB/s. Input signals conforming to EIA Standards 232-E, 422A and CCITT V.10, V.11, V.28, X.26, and X.27 are accepted and translated into TTL /CMOS output signal levels.

The ADM5180 is a superior upgrade for the UC5180C and the NE5180. It is fabricated on an advanced BiCMOS process, allowing high speed bipolar circuitry to be combined with low power CMOS. This minimizes the power consumption to less than 25 mW.

A failsafe function ensures a known output state under a variety of input fault conditions as defined in RS-422A and RS-423A. The failsafe function is controlled by FS1 and FS2. Each controls four receivers. With FS = Low and a fault condition the output is forced low while if FS = High, the output is forced high.

The device is available in both 28-pin DIP and 28-lead PLCC packages.

FUNCTIONAL BLOCK DIAGRAM

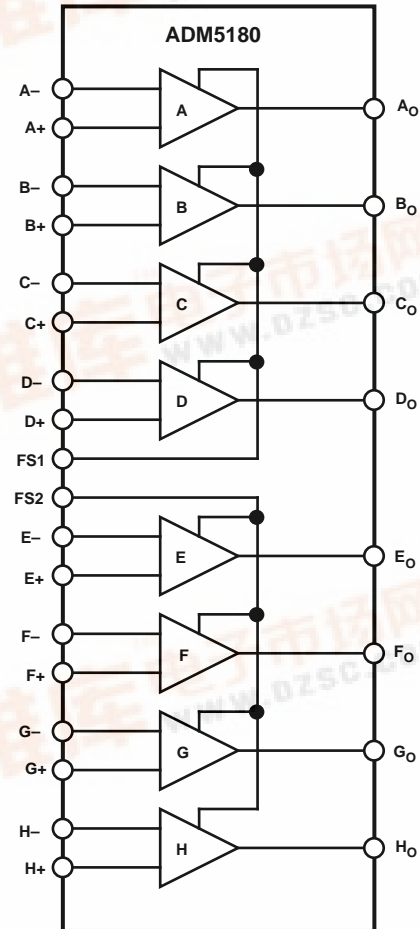

Truth Table

Differential Input (+) - (-)	Failsafe Input FS1, FS2	Receiver Logic Output
>200 mV	X	H
<-200 mV	X	L
O/C	L	L
S/C	L	L
O/C	H	H
S/C	H	H



ADM5180–SPECIFICATIONS ($V_{DD} = +5\text{ V} \pm 5\%$, Input Common-Mode Range = $\pm 7\text{ V}$. All Specifications T_{MIN} to T_{MAX} unless otherwise noted.)

Parameter	Min	Typ	Max	Units	Test Conditions/Comments
POWER REQUIREMENTS					
V_{DD}	4.75		5.25	V	
I_{DD}		3.5	5	mA	
INPUTS					
Input Resistance, R_{IN}	3		7	k Ω	$3\text{ V} \leq V_{IN} \leq 25\text{ V}$
Differential Input High Threshold, V_{TH}	50		200	mV	$R_S = 0\ \Omega$, $V_{OUT} = 2.7\text{ V}$, $I_{OUT} = -440\ \mu\text{A}$, See Figure 1
			400	mV	$R_S = 500\ \Omega$, $V_{OUT} = 2.7\text{ V}$, $I_{OUT} = -440\ \mu\text{A}$, See Figure 1
Differential Input Low Threshold, V_{TL}	-200		-50	mV	$R_S = 0\ \Omega$, $V_{OUT} = 0.45\text{ V}$, $I_{OUT} = 8\text{ mA}$, See Figure 1
	-400			mV	$R_S = 500\ \Omega$, $V_{OUT} = 0.45\text{ V}$, $I_{OUT} = 8\text{ mA}$, See Figure 1
Hysteresis, V_H	50		140	mV	FS1, FS2 = 0 V or V_{DD} , See Figure 1
Open Circuit Input Voltage, V_{IOC}			60	mV	
Input Capacitance			20	pF	
Input Current, I_{IN}			3.25	mA	$V_{IN} = +10\text{ V}$
	-3.25			mA	$V_{IN} = -10\text{ V}$
OUTPUTS					
High Level Output Voltage, V_{OH}	2.7			V	$V_{ID} = 1.0\text{ V}$, $I_{OUT} = -440\ \mu\text{A}$
Low Level Output Voltage, V_{OL}			0.4	V	$V_{ID} = -1.0\text{ V}$, $I_{OUT} = 4\text{ mA}$
			0.45	V	$V_{ID} = -1.0\text{ V}$, $I_{OUT} = 8\text{ mA}$, $T_A = 0^\circ\text{C}$ to $+70^\circ\text{C}$
Short Circuit O/P Current, I_{OS}			100	mA	Note 1
FAILSAFE FUNCTION					
Failsafe Output Voltage, V_{OFS}			0.40	V	Inputs Open or Shorted Together or One Input Open and One Grounded
			0.45	V	$0 \leq I_{OUT} \leq 4\text{ mA}$; FS1, FS2 = 0 V
				V	$0 \leq I_{OUT} \leq 8\text{ mA}$, $T_A = 0^\circ\text{C}$ to $+70^\circ\text{C}$; FS1, FS2 = 0 V
FS1, FS2 Input Current	2.7			V	$0 \geq I_{OUT} \geq -400\ \mu\text{A}$; FS1, FS2 = V_{DD}
	-10		+10	μA	

NOTE

¹Only one output may be shorted at any time.

Specifications subject to change without notice.

TIMING CHARACTERISTICS ($V_{DD} = +5\text{ V} \pm 5\%$. All Specifications T_{MIN} to T_{MAX} unless otherwise noted)

Parameter	Min	Typ	Max	Units	Test Conditions/Comments
Propagation Delay–Low to High			550	ns	$C_L = 50\text{ pF}$, $V_{IN} = \pm 500\text{ mV}$
Propagation Delay–High to Low			550	ns	$C_L = 50\text{ pF}$, $V_{IN} = \pm 500\text{ mV}$
Acceptable Input Frequency			0.1	MHz	Unused Input Grounded, $V_{IN} = \pm 200\text{ mV}$
Rejectable Input Frequency	5.5			MHz	Unused Input Grounded, $V_{IN} = \pm 500\text{ mV}$

Specifications subject to change without notice.

ABSOLUTE MAXIMUM RATINGS¹

(T_A = 25°C unless otherwise noted)

V _{DD}	+7 V
Common-Mode Input Voltage	+15 V
Differential Input Voltage	+25 V
Failsafe Voltage	-0.3 V to V _{CC}
Output Short Circuit Duration	Continuous ²
Power Dissipation Plastic DIP	1250 mW
(Derate at 12.5 mW/°C Above +50°C)	
θ _{JA} , Thermal Impedance	75°C/W
Power Dissipation PLCC	1000 mW
(Derate at 12.5 mW/°C Above +50°C)	
θ _{JA} , Thermal Impedance	+80°C/W

Operating Temperature Range

Commercial (J Version)	0°C to +70°C
Industrial (A Version)	-40°C to +80°C
Lead Temperature (Soldering 10 sec)	+300°C
Vapour Phase (60 sec)	+215°C
Infrared (15 sec)	+220°C

NOTES

¹This is a stress rating only and functional operation of the device at these or any other conditions above those indicated in the operation sections of this specification is not implied. Exposure to absolute maximum rating conditions for extended periods of time may affect reliability.

²Only one output should be shorted at any time.

CAUTION

ESD (electrostatic discharge) sensitive device. Electrostatic charges as high as 4000 V readily accumulate on the human body and test equipment and can discharge without detection. Although the ADM5180 features proprietary ESD protection circuitry, permanent damage may occur on devices subjected to high energy electrostatic discharges. Therefore, proper ESD precautions are recommended to avoid performance degradation or loss of functionality.

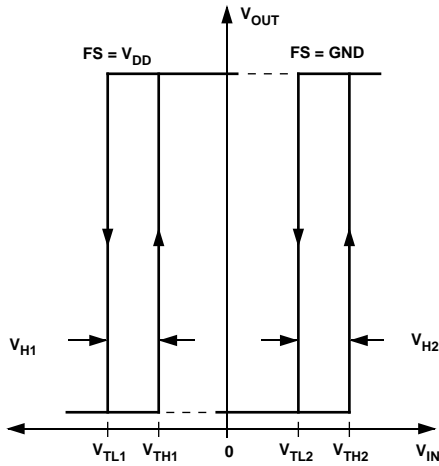

Figure 1. V_{TL}, V_{TH}, V_H Definition

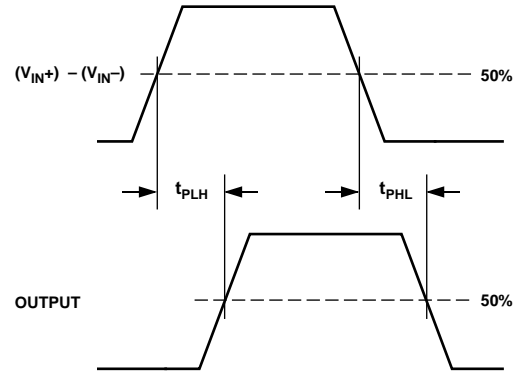

Figure 3. Timing Waveform

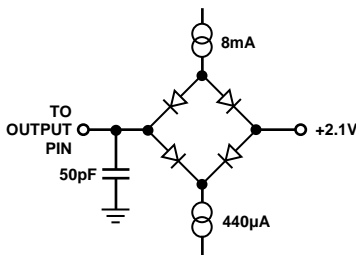

Figure 2. Timing Test Load

ORDERING GUIDE

Model	Temperature Range	Package Option
ADM5180JN	0°C to +70°C	N-28
ADM5180AN	-40°C to +85°C	N-28
ADM5180JP	0°C to +70°C	P-28A
ADM5180AP	-40°C to +85°C	P-28A

ADM5180

PIN CONFIGURATIONS

DIP

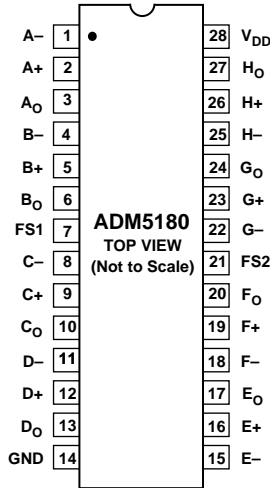

PLCC

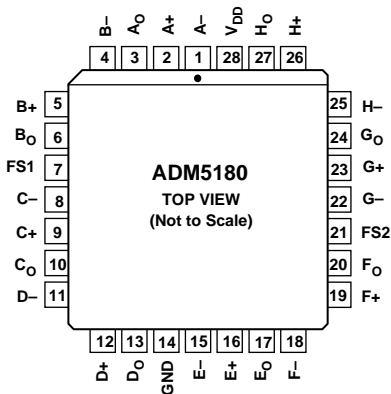

PIN DESCRIPTION

Mnemonic	Function
V _{DD}	Power Supply Input, 5 V ± 5%.
GND	Ground Pin. Must be connected to 0 V.
A+ . . . H+	Noninverting Input to Differential Receivers A to H.
A- . . . H-	Inverting Input to Differential Receivers A to H.
A ₀ . . . H ₀	Receiver Outputs A to H.
FS1, FS2	Failsafe Control Inputs. FS1 controls receivers A through D and FS2 control Receiver E through H.

APPLICATIONS INFORMATION

FAILSAFE OPERATION

The ADM5180 provides a failsafe operating mode to guard against input fault conditions as defined in RS-422A and RS-423A standards. The fault conditions are (1) Driver in power-off condition, (2) Receiver not interconnected with Driver, (3) Open-circuited interconnecting cable, and (4) Short-circuited interconnecting cable. If any of these four fault conditions occurs at the inputs of a receiver, then the output of that receiver is driven to a known logic level. The failsafe level is programmed using the failsafe (FS) input. There are two failsafe inputs, FS1 and FS2 which each control four receivers. FS1 controls receivers A . . . D and FS2 controls receivers E . . . H. A connection to V_{DD} on the failsafe input sets the output high under fault conditions while a connection to GND sets the output low.

FS1, FS2	Output During Fault Condition
V _{DD}	High
GND	Low

Input Filtering

The ADM5180 contains internal low pass filtering for additional noise rejection. Frequencies above the passband will be rejected. For the specified input (5.5 MHz at ±500 mV) the input stage attenuates the signal such that the threshold levels are not reached and therefore no change of state occurs on the output. The filtering is a function of both amplitude and frequency. As the signal amplitude decreases then the rejected frequency will decrease.

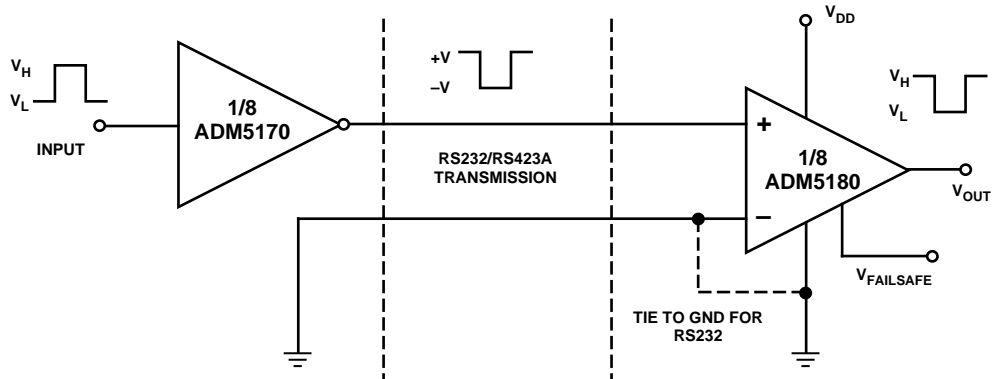

Figure 4. EIA-232/V.28 Data Transmission

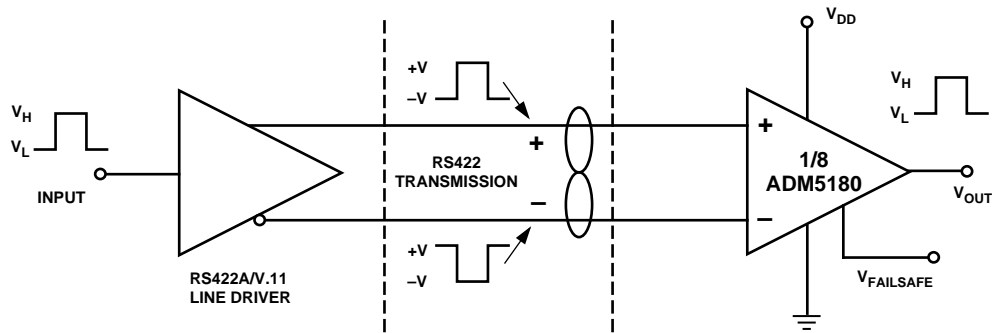

Figure 5. RS-422A/V.11 Data Transmission

Typical Performance Characteristics

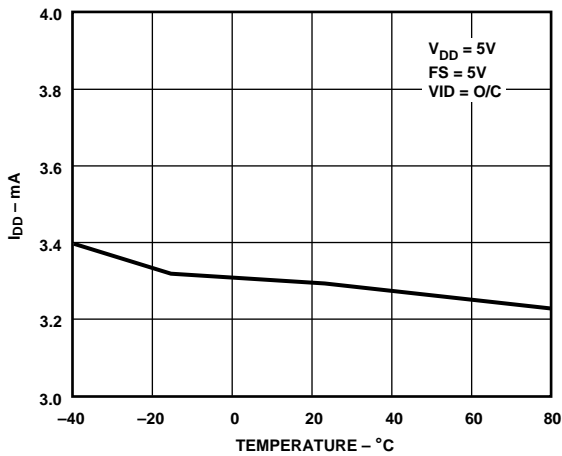

Figure 6. Supply Current vs. Temperature

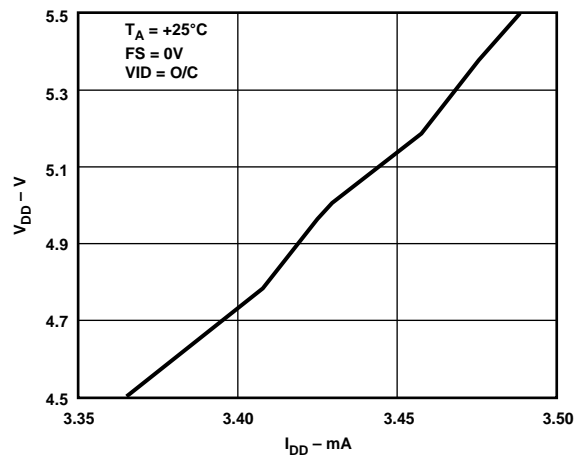

Figure 7. Supply Current vs. Supply Voltage

ADM5180

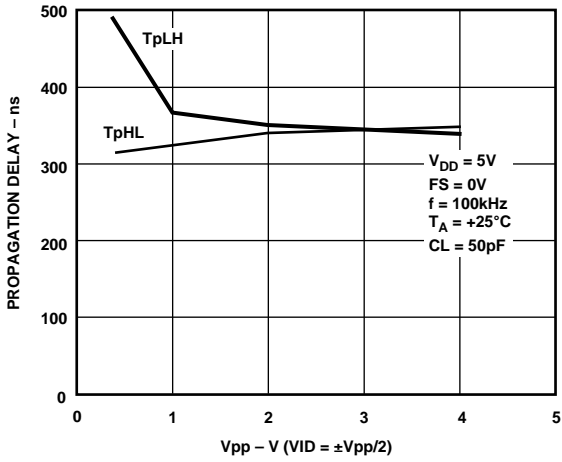

Figure 8. Propagation Delay vs. Amplitude

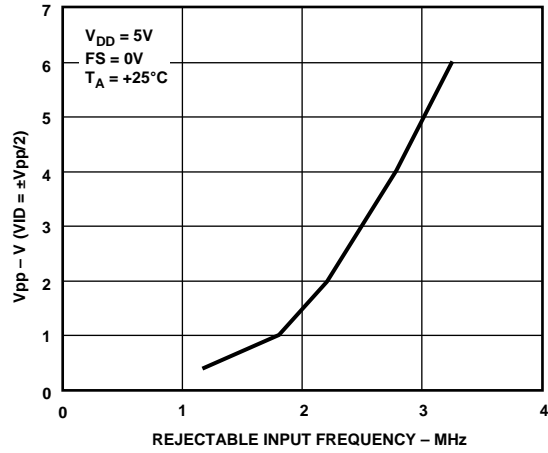

Figure 10. Rejectable Input Frequency vs. Amplitude

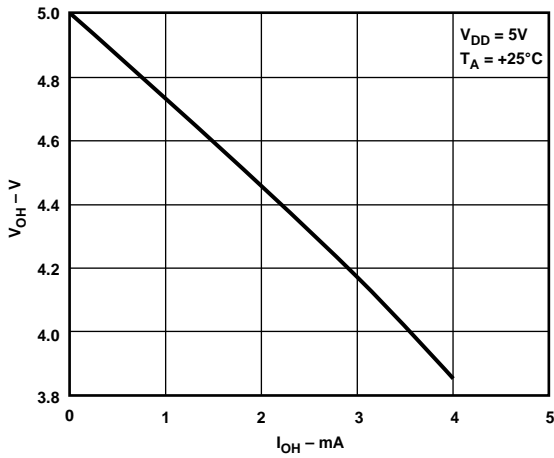

Figure 9. High Level Output Voltage vs. Output Source Current

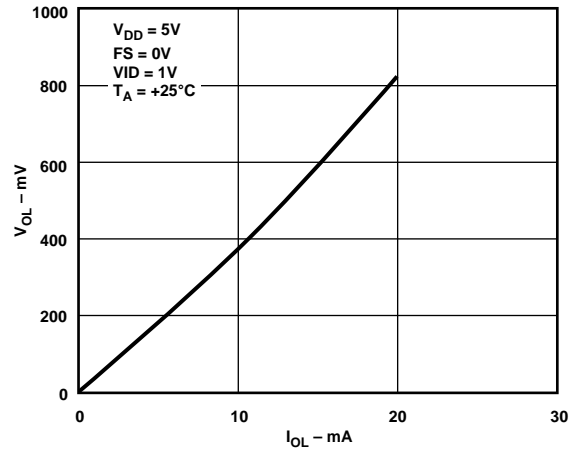
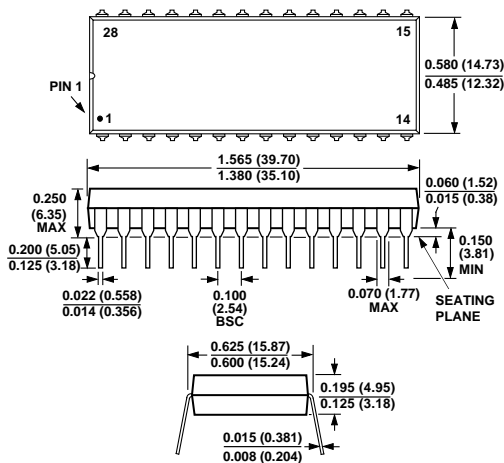

Figure 11. Low Level Output Voltage vs. Output Sink Current

OUTLINE DIMENSIONS

Dimensions shown in inches and (mm).

28-Lead Plastic DIP (N Suffix)



28-Lead Plastic Leaded Chip Carrier (PLCC) (P Suffix)

