



# LT1259/LT1260

## Low Cost Dual and Triple 130MHz Current Feedback Amplifiers with Shutdown

### FEATURES

- 90MHz Bandwidth on  $\pm 5V$
- 0.1dB Gain Flatness > 30MHz
- Completely Off in Shutdown, 0 $\mu A$  Supply Current
- High Slew Rate: 1600V/ $\mu s$
- Wide Supply Range:  $\pm 2V(4V)$  to  $\pm 15V(30V)$
- 60mA Output Current
- Low Supply Current: 5mA/Amplifier
- Differential Gain: 0.016%
- Differential Phase: 0.075°
- Fast Turn-On Time: 100ns
- Fast Turn-Off Time: 40ns
- 14-Pin and 16-Pin Narrow SO Packages

### APPLICATIONS

- RGB Cable Drivers
- Spread Spectrum Amplifiers
- MUX Amplifiers
- Composite Video Cable Drivers
- Portable Equipment

### DESCRIPTION

The LT<sup>®</sup>1259 contains two independent 130MHz current feedback amplifiers, each with a shutdown pin. These amplifiers are designed for excellent linearity while driving cables and other low impedance loads. The LT1260 is a triple version especially suited to RGB video applications. These amplifiers operate on all supplies from single 5V to  $\pm 15V$  and draw only 5mA per amplifier when active.

When shut down, the LT1259/LT1260 amplifiers draw zero supply current and their outputs become high impedance. Only two LT1260s are required to make a complete 2-input RGB MUX and cable driver. These amplifiers turn on in only 100ns and turn off in 40ns, making them ideal in spread spectrum and portable equipment applications.

The LT1259/LT1260 amplifiers are manufactured on Linear Technology's proprietary complementary bipolar process.

LTC and LT are registered trademarks of Linear Technology Corporation.

### TYPICAL APPLICATION

2-Input Video MUX Cable Driver

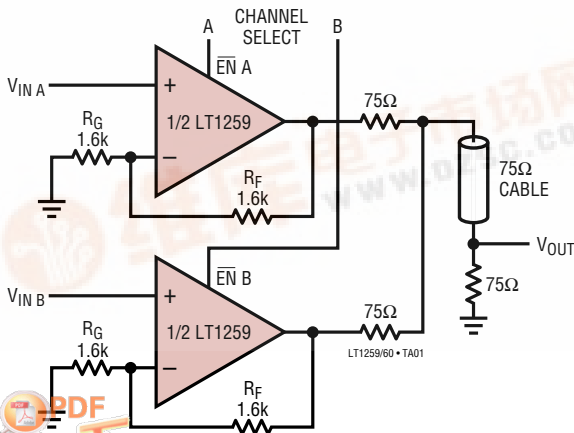

Square Wave Response

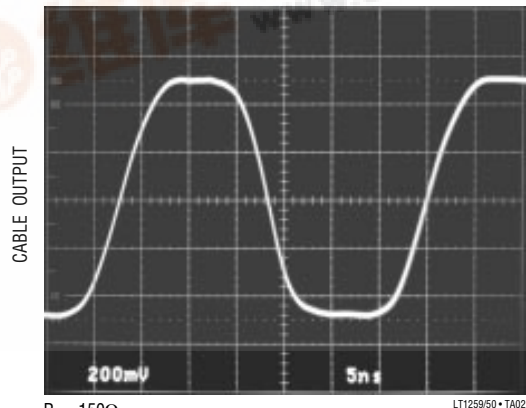

$R_L = 150\Omega$   
 $f = 30MHz$



# LT1259/LT1260

## ABSOLUTE MAXIMUM RATINGS

|  |                               |  |                                  |
|--|-------------------------------|--|----------------------------------|
| Supply Voltage .....                         | $\pm 18V$                     | Operating Temperature Range .....          | $-40^{\circ}C$ to $85^{\circ}C$  |
| Input Current .....                          | $\pm 15mA$                    | Storage Temperature Range .....            | $-65^{\circ}C$ to $150^{\circ}C$ |
| Output Short-Circuit Duration (Note 1) ..... | Continuous                    | Junction Temperature (Note 4) .....        | $150^{\circ}C$                   |
| Specified Temperature Range (Note 2) .....   | $0^{\circ}C$ to $70^{\circ}C$ | Lead Temperature (Soldering, 10 sec) ..... | $300^{\circ}C$                   |

## PACKAGE/ORDER INFORMATION

|  |   |  |   |
|--|---|--|---|
| <p>TOP VIEW</p> <p>N PACKAGE<br/>14-LEAD PLASTIC DIP</p> <p>S PACKAGE<br/>14-LEAD PLASTIC SOIC</p> <p><math>T_{JMAX} = 150^{\circ}C, \theta_{JA} = 70^{\circ}C/W</math> (N)<br/><math>T_{JMAX} = 150^{\circ}C, \theta_{JA} = 110^{\circ}C/W</math> (S)</p> | <p>ORDER PART NUMBER</p> <p>LT1259CN*<br/>LT1259CS*</p> | <p>TOP VIEW</p> <p>N PACKAGE<br/>16-LEAD PLASTIC DIP</p> <p>S PACKAGE<br/>16-LEAD PLASTIC SOIC</p> <p><math>T_{JMAX} = 150^{\circ}C, \theta_{JA} = 70^{\circ}C/W</math> (N)<br/><math>T_{JMAX} = 150^{\circ}C, \theta_{JA} = 100^{\circ}C/W</math> (S)</p> | <p>ORDER PART NUMBER</p> <p>LT1260CN*<br/>LT1260CS*</p> |
|--|---|--|---|

\*See Notes 2 and 3. Consult factory for Industrial and Military grade parts.

## ELECTRICAL CHARACTERISTICS

$0^{\circ}C \leq T_A \leq 70^{\circ}C$ , each amplifier  $V_{CM} = 0V, \pm 5V \leq V_S \leq \pm 15V, \overline{EN}$  pins =  $0V$ , pulse tested, unless otherwise noted.

| SYMBOL       | PARAMETER                                | CONDITIONS  | MIN | TYP | MAX | UNITS             |
|--------------|--|---|-----|-----|-----|-------------------|
| $V_{OS}$     | Input Offset Voltage                     | $T_A = 25^{\circ}C$                                 |     | 2   | 12  | mV                |
|              |  |   |     |     |     | 16                |
|              | Input Offset Voltage Drift               |   |     | 30  |     | $\mu V/^{\circ}C$ |
| $I_{IN}^{+}$ | Noninverting Input Current               | $T_A = 25^{\circ}C$                                 |     | 0.5 | 3   | $\mu A$           |
|              |  |   |     |     |     | 6                 |
| $I_{IN}^{-}$ | Inverting Input Current                  | $T_A = 25^{\circ}C$                                 |     | 20  | 90  | $\mu A$           |
|              |  |   |     |     |     | 120               |
| $e_n$        | Input Noise Voltage Density              | $f = 1kHz, R_F = 1k, R_G = 10\Omega, R_S = 0\Omega$ |     | 3.6 |     | $nV/\sqrt{Hz}$    |
| $+i_n$       | Noninverting Input Noise Current Density | $f = 1kHz$  |     | 1.3 |     | $pA/\sqrt{Hz}$    |
| $-i_n$       | Inverting Input Noise Current Density    | $f = 1kHz$  |     | 45  |     | $pA/\sqrt{Hz}$    |
| $R_{IN}$     | Input Resistance                         | $V_{IN} = \pm 13V, V_S = \pm 15V$                   |     | 2   | 17  | $M\Omega$         |
|              |  | $V_{IN} = \pm 3V, V_S = \pm 5V$                     |     | 2   | 25  | $M\Omega$         |
| $C_{IN}$     | Input Capacitance                        | Enabled   |     | 2   |     | pF                |
|              |  | Disabled  |     | 4   |     | pF                |
| $C_{OUT}$    | Output Capacitance                       | Disabled  |     | 4.4 |     | pF                |

## ELECTRICAL CHARACTERISTICS

0°C ≤ T<sub>A</sub> ≤ 70°C, each amplifier V<sub>CM</sub> = 0V, ±5V ≤ V<sub>S</sub> ≤ ±15V,  $\overline{EN}$  pins = 0V, pulse tested, unless otherwise noted.

| SYMBOL                          | PARAMETER   | CONDITIONS   | MIN  | TYP   | MAX   | UNITS |
|---------------------------------|---|--|--|-------|-------|-------|
| V <sub>IN</sub>                 | Input Voltage Range   | V <sub>S</sub> = ±15V, T <sub>A</sub> = 25°C   | ±13  | ±13.5 |       | V     |
|                                 |   |  | ±12  |       |       | V     |
|                                 |   | V <sub>S</sub> = ±5V, T <sub>A</sub> = 25°C  | ±3   | ±3.5  |       | V     |
|                                 |   |  | ±2   |       |       | V     |
| V <sub>OUT</sub>                | Maximum Output Voltage Swing                                      | V <sub>S</sub> = ±15V, R <sub>L</sub> = 1k   | ±12.0  | ±14.0 |       | V     |
|                                 |   | V <sub>S</sub> = ±5V, R <sub>L</sub> = 150Ω, T <sub>A</sub> = 25°C                           | ±3.0   | ±3.7  |       | V     |
|                                 |   |  | ±2.5   |       |       | V     |
| CMRR                            | Common-Mode Rejection Ratio                                       | V <sub>S</sub> = ±15V, V <sub>CM</sub> = ±13V, T <sub>A</sub> = 25°C                         | 55   | 69    |       | dB    |
|                                 |   | V <sub>S</sub> = ±15V, V <sub>CM</sub> = ±12V  | 55   |       |       | dB    |
|                                 |   | V <sub>S</sub> = ±5V, V <sub>CM</sub> = ±3V, T <sub>A</sub> = 25°C                           | 52   | 63    |       | dB    |
|                                 |   | V <sub>S</sub> = ±5V, V <sub>CM</sub> = ±2V  | 52   |       |       | dB    |
|                                 | Inverting Input Current<br>Common-Mode Rejection                  | V <sub>S</sub> = ±15V, V <sub>CM</sub> = ±13V, T <sub>A</sub> = 25°C                         |  | 3.5   | 10    | μA/V  |
|                                 |   | V <sub>S</sub> = ±15V, V <sub>CM</sub> = ±12V  |  |       | 10    | μA/V  |
|                                 |   | V <sub>S</sub> = ±5V, V <sub>CM</sub> = ±3V, T <sub>A</sub> = 25°C                           |  | 4.5   | 15    | μA/V  |
|                                 |   | V <sub>S</sub> = ±5V, V <sub>CM</sub> = ±2V  |  |       | 15    | μA/V  |
| PSRR                            | Power Supply Rejection Ratio                                      | V <sub>S</sub> = ±2V to ±15V, $\overline{EN}$ Pins at V <sup>-</sup> , T <sub>A</sub> = 25°C | 60   | 80    |       | dB    |
|                                 |   | V <sub>S</sub> = ±3V to ±15V, $\overline{EN}$ Pins at V <sup>-</sup>                         | 60   |       |       | dB    |
|                                 | Noninverting Input Current<br>Power Supply Rejection              | V <sub>S</sub> = ±2V to ±15V, $\overline{EN}$ Pins at V <sup>-</sup> , T <sub>A</sub> = 25°C |  | 15    | 65    | nA/V  |
|                                 |   | V <sub>S</sub> = ±3V to ±15V, $\overline{EN}$ Pins at V <sup>-</sup>                         |  |       | 75    | nA/V  |
|                                 | Inverting Input Current<br>Power Supply Rejection                 | V <sub>S</sub> = ±2V to ±15V, $\overline{EN}$ Pins at V <sup>-</sup> , T <sub>A</sub> = 25°C |  | 0.1   | 5     | μA/V  |
|                                 |   | V <sub>S</sub> = ±3V to ±15V, $\overline{EN}$ Pins at V <sup>-</sup>                         |  |       | 5     | μA/V  |
| A <sub>V</sub>                  | Large-Signal Voltage Gain   | V <sub>S</sub> = ±15V, V <sub>OUT</sub> = ±10V, R <sub>L</sub> = 1k                          | 57   | 72    |       | dB    |
|                                 |   | V <sub>S</sub> = ±5V, V <sub>OUT</sub> = ±2V, R <sub>L</sub> = 150Ω                          | 57   | 69    |       | dB    |
| R <sub>OL</sub>                 | Transresistance, ΔV <sub>OUT</sub> /ΔI <sub>IN</sub> <sup>-</sup> | V <sub>S</sub> = ±15V, V <sub>OUT</sub> = ±10V, R <sub>L</sub> = 1k                          | 120  | 300   |       | kΩ    |
|                                 |   | V <sub>S</sub> = ±5V, V <sub>OUT</sub> = ±2V, R <sub>L</sub> = 150Ω                          | 100  | 200   |       | kΩ    |
| I <sub>OUT</sub>                | Maximum Output Current  | R <sub>L</sub> = 0Ω, T <sub>A</sub> = 25°C   | 30   | 60    |       | mA    |
| I <sub>S</sub>                  | Supply Current per Amplifier<br>(Note 5)                          | V <sub>S</sub> = ±15V, V <sub>OUT</sub> = 0V, T <sub>A</sub> = 25°C                          |  | 5.0   | 7.5   | mA    |
|                                 |   | V <sub>S</sub> = ±5V, V <sub>OUT</sub> = 0V, T <sub>A</sub> = 25°C                           |  | 4.5   | 6.7   | mA    |
|                                 | Disable Supply Current per Amplifier                              | V <sub>S</sub> = ±15V, $\overline{EN}$ Pin Voltage = 14.5V, R <sub>L</sub> = 150Ω            |  | 3     | 16.7  | μA    |
|                                 |   | V <sub>S</sub> = ±15V, Sink 1μA From $\overline{EN}$ Pin                                     |  | 1     | 2.7   | μA    |
|                                 | Enable Pin Current  | V <sub>S</sub> = ±15V, $\overline{EN}$ Pin Voltage = 0V, T <sub>A</sub> = 25°C               |  | 60    | 200   | μA    |
|                                 |   |  |  |       | 300   | μA    |
| SR                              | Slew Rate (Note 6)  | T <sub>A</sub> = 25°C  | 900  | 1600  |       | V/μs  |
| t <sub>ON</sub>                 | Turn-On Delay Time (Note 7)                                       | A <sub>V</sub> = 10, T <sub>A</sub> = 25°C   |  | 100   | 400   | ns    |
| t <sub>OFF</sub>                | Turn-Off Delay Time (Note 7)                                      | A <sub>V</sub> = 10, T <sub>A</sub> = 25°C   |  | 40    | 150   | ns    |
| t <sub>r</sub> , t <sub>f</sub> | Small-Signal Rise and Fall Time                                   | V <sub>S</sub> = ±12V, R <sub>F</sub> = R <sub>G</sub> = 1.5k, R <sub>L</sub> = 150Ω         |  | 4.2   |       | ns    |
|                                 |   | Propagation Delay  | V <sub>S</sub> = ±12V, R <sub>F</sub> = R <sub>G</sub> = 1.5k, R <sub>L</sub> = 150Ω |       | 4.7   |       |
|                                 | Small-Signal Overshoot  | V <sub>S</sub> = ±12V, R <sub>F</sub> = R <sub>G</sub> = 1.5k, R <sub>L</sub> = 150Ω         |  | 5     |       | %     |
| t <sub>S</sub>                  | Settling Time   | 0.1%, V <sub>OUT</sub> = 10V, R <sub>F</sub> = R <sub>G</sub> = 1.5k, R <sub>L</sub> = 1k    |  | 75    |       | ns    |
|                                 |   | Differential Gain (Note 8)   | V <sub>S</sub> = ±12V, R <sub>F</sub> = R <sub>G</sub> = 1.5k, R <sub>L</sub> = 150Ω |       | 0.016 |       |
|                                 | Differential Phase (Note 8)                                       | V <sub>S</sub> = ±12V, R <sub>F</sub> = R <sub>G</sub> = 1.5k, R <sub>L</sub> = 150Ω         |  | 0.075 |       | DEG   |

The ● denotes specifications which apply over the specified operating temperature range.

**Note 1:** A heat sink may be required depending on the power supply voltage and how many amplifiers have their outputs short circuited.

**Note 2:** Commercial grade parts are designed to operate over the temperature range of -40°C to 85°C but are neither tested nor guaranteed beyond 0°C to 70°C. Industrial grade parts specified and tested over -40°C to 85°C are available on special request. Consult factory.

# LT1259/LT1260

## ELECTRICAL CHARACTERISTICS

**Note 3:** Ground pins are not internally connected. For best performance, connect to ground.

**Note 4:**  $T_J$  is calculated from the ambient temperature  $T_A$  and the power dissipation  $P_D$  according to the following formulas:

$$\text{LT1259CN: } T_J = T_A + (P_D \cdot 70^\circ\text{C/W})$$

$$\text{LT1259CS: } T_J = T_A + (P_D \cdot 110^\circ\text{C/W})$$

$$\text{LT1260CN: } T_J = T_A + (P_D \cdot 70^\circ\text{C/W})$$

$$\text{LT1260CS: } T_J = T_A + (P_D \cdot 100^\circ\text{C/W})$$

**Note 5:** The supply current of the LT1259/LT1260 has a negative temperature coefficient. See Typical Performance Characteristics.

**Note 6:** Slew rate is measured at  $\pm 5\text{V}$  on a  $\pm 10\text{V}$  output signal while operating on  $\pm 15\text{V}$  supplies with  $R_F = 1\text{k}$ ,  $R_G = 110\Omega$  and  $R_L = 1\text{k}$ .

**Note 7:** Turn-on delay time is measured while operating on  $\pm 5\text{V}$  supplies with  $R_F = 1\text{k}$ ,  $R_G = 110\Omega$  and  $R_L = 150\Omega$ . The  $t_{ON}$  is measured from control input to appearance of  $0.5\text{V}$  at the output, for  $V_{IN} = 0.1\text{V}$ . Likewise, turn-off delay time is measured from control input to appearance of  $0.5\text{V}$  on the output for  $V_{IN} = 0.1\text{V}$ .

**Note 8:** Differential gain and phase are measured using a Tektronix TSG120YC/NTSC signal generator and a Tektronix 1780R Video Measurement Set. The resolution of this equipment is  $0.1\%$  and  $0.1^\circ$ . Six identical amplifier stages were cascaded giving an effective resolution of  $0.016\%$  and  $0.016^\circ$ .

## TYPICAL AC PERFORMANCE

| $V_S$ (V) | $A_V$ | $R_L$ ( $\Omega$ ) | $R_F$ ( $\Omega$ ) | $R_G$ ( $\Omega$ ) | SMALL SIGNAL<br>-3dB BW (MHz) | SMALL SIGNAL<br>0.1dB BW (MHz) | SMALL SIGNAL<br>PEAKING (dB) |
|-----------|-------|--------------------|--------------------|--------------------|-------------------------------|--------------------------------|------------------------------|
| $\pm 12$  | 2     | 150                | 1.5k               | 1.5k               | 130                           | 53                             | 0.1                          |
| $\pm 5$   | 2     | 150                | 1.1k               | 1.1k               | 93                            | 40                             | 0                            |
| $\pm 12$  | 10    | 150                | 1.1k               | 121                | 69                            | 20                             | 0.13                         |
| $\pm 5$   | 10    | 150                | 825                | 90.9               | 61                            | 16                             | 0                            |

## TYPICAL PERFORMANCE CHARACTERISTICS

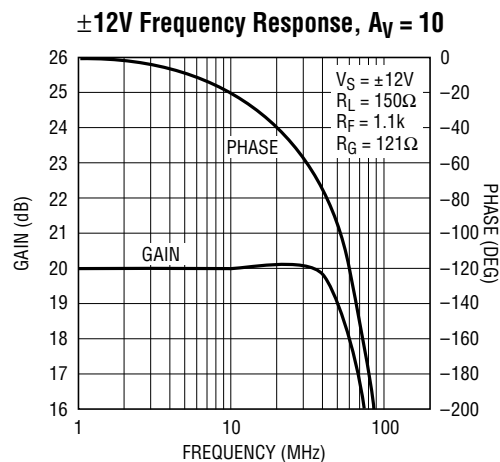
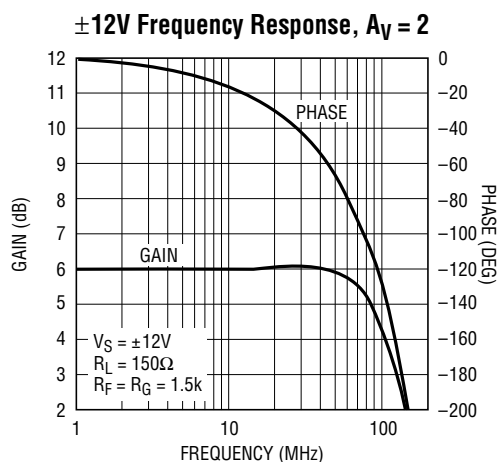

# TYPICAL PERFORMANCE CHARACTERISTICS

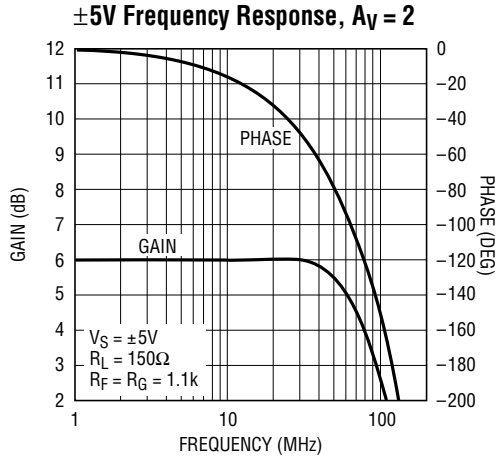

LT1259/60 • TPC03

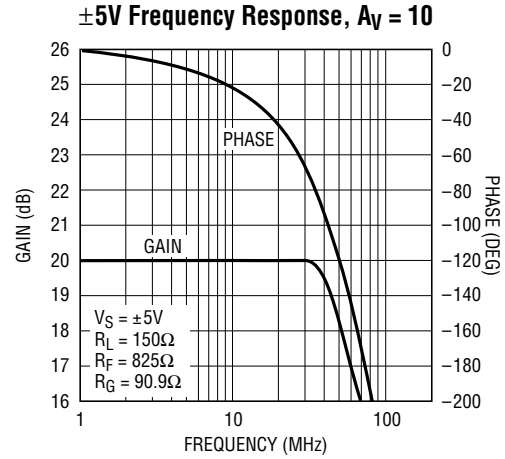

LT1259/60 • TPC04

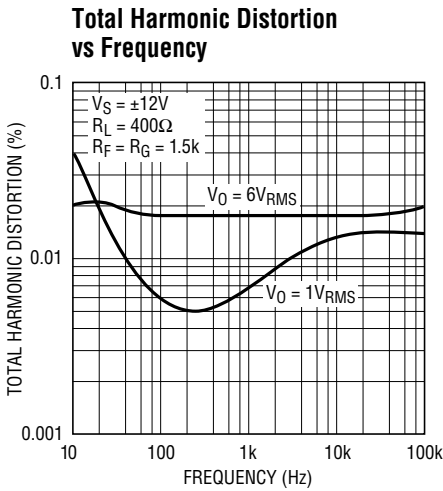

LT1259/60 • TPC05

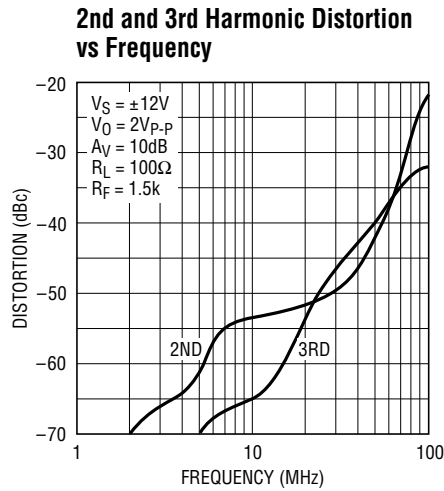

LT12359/60 • TPC06

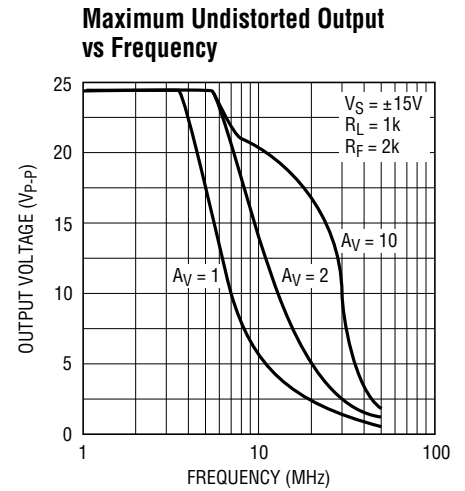

LT12359/60 • TPC07

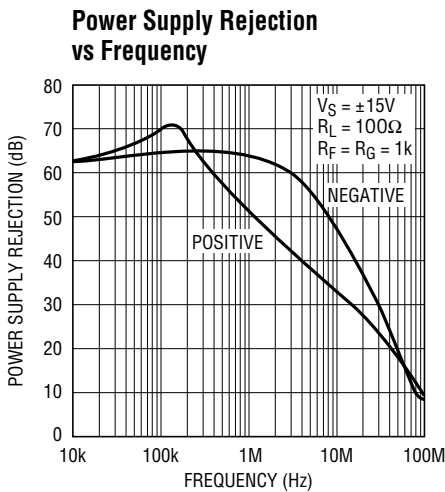

LT1259/60 • TPC08

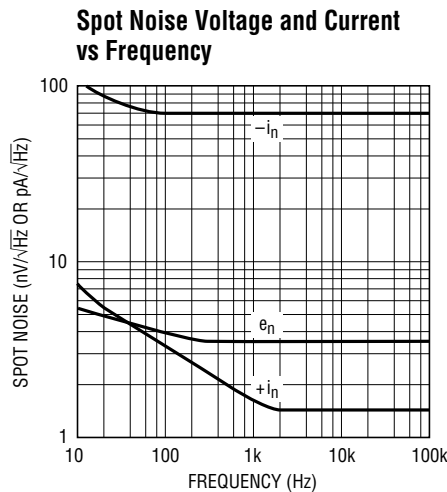

LT1259/60 • TPC09

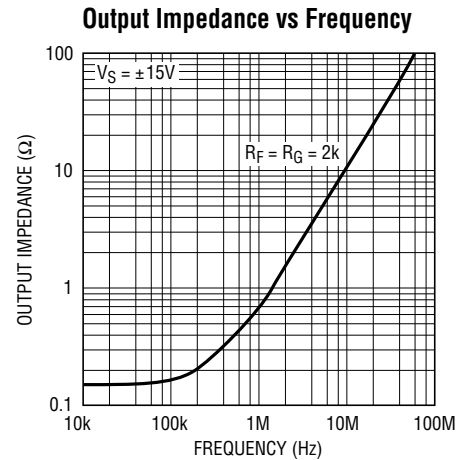

LT1259/60 • TPC10

# LT1259/LT1260

## TYPICAL PERFORMANCE CHARACTERISTICS

**Output Impedance in Shutdown vs Frequency**

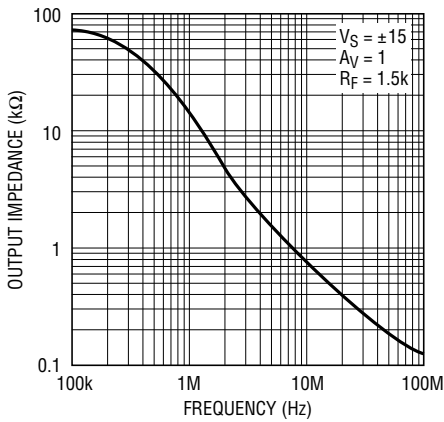

LT1259/60 • TPC11

**Maximum Capacitive Load vs Feedback Resistor**

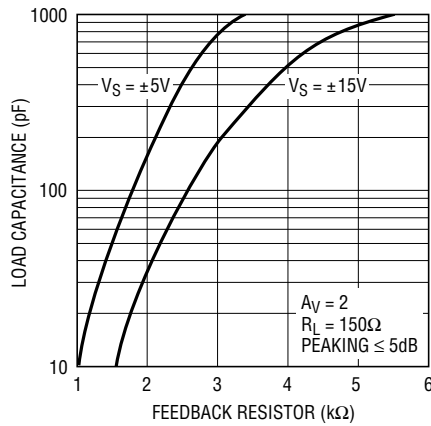

LT1259/60 • TPC12

**Supply Current vs Supply Voltage**

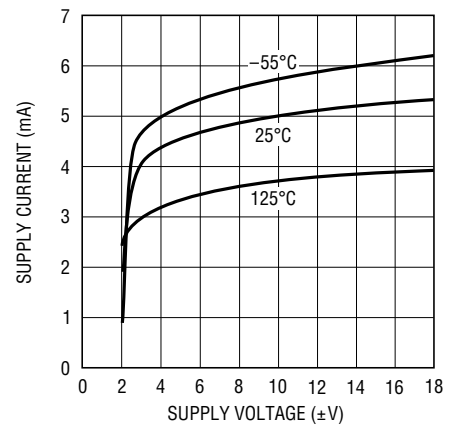

LT1259/60 • TPC13

**Output Saturation Voltage vs Temperature**

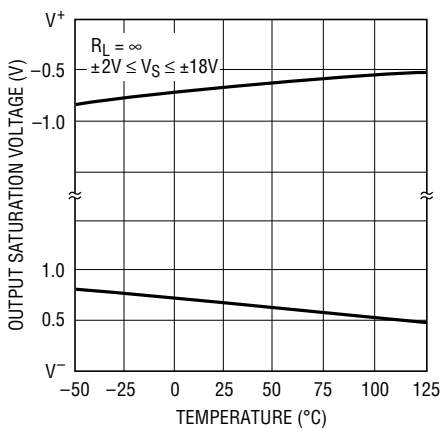

LT1259/60 • TPC14

**Input Common-Mode Limit vs Temperature**

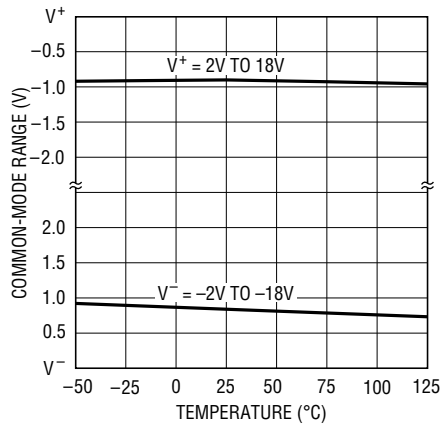

LT1259/60 • TPC16

**Output Short-Circuit Current vs Junction Temperature**

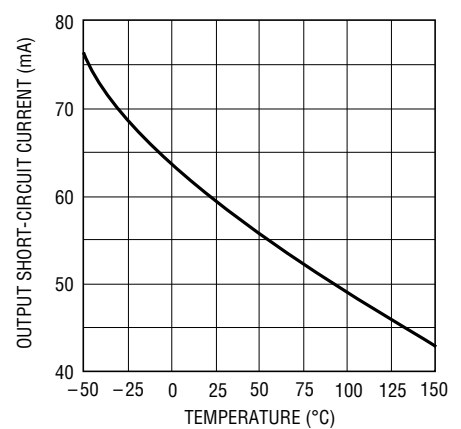

LT1259/60 • TPC15

**Settling Time to 10mV vs Output Step**

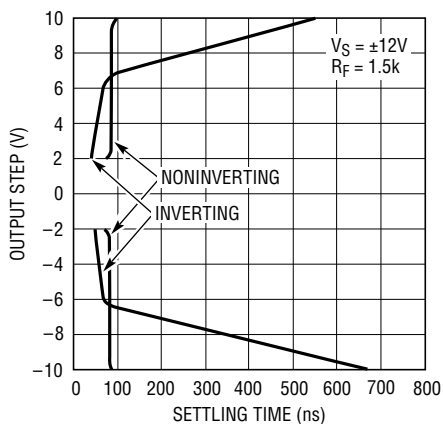

LT1259/60 • TPC17

**Small-Signal Rise Time**

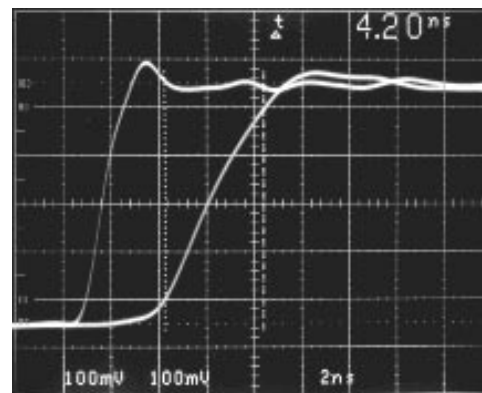

$V_S = \pm 15V$   $R_F = R_G = 1.6k$   
 $A_V = 2$   $R_L = 150\Omega$

LT1259/60 G19

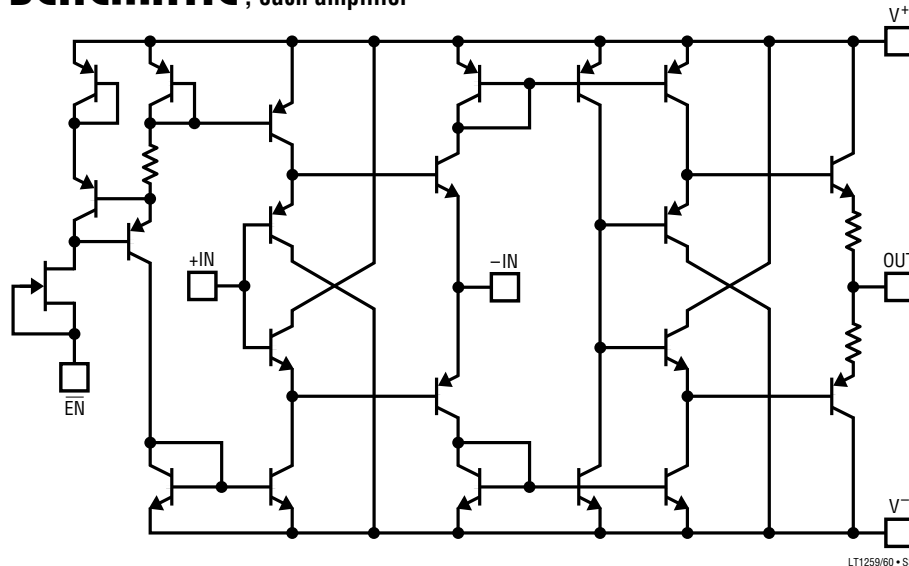
**SIMPLIFIED SCHEMATIC**, each amplifier**APPLICATIONS INFORMATION****Feedback Resistor Selection**

The small-signal bandwidth of the LT1259/LT1260 are set by the external feedback resistors and the internal junction capacitors. As a result, the bandwidth is a function of the supply voltage, the value of the feedback resistor, the closed-loop gain and the load resistor. The LT1259/LT1260 have been optimized for  $\pm 5\text{V}$  supply operation and have a  $-3\text{dB}$  bandwidth of  $90\text{MHz}$ . See resistor selection guide in Typical AC Performance table.

**Capacitance on the Inverting Input**

Current feedback amplifiers require resistive feedback from the output to the inverting input for stable operation. Take care to minimize the stray capacitance between the output and the inverting input. Capacitance on the inverting input to ground will cause peaking in the frequency response (and overshoot in the transient response). See the section on Demo Board Information.

**Capacitive Loads**

The LT1259/LT1260 can drive capacitive loads directly when the proper value of feedback resistor is used. The graph of Maximum Capacitive Load vs Feedback Resistor should be used to select the appropriate value. The value shown is for  $\leq 5\text{dB}$  peaking when driving a  $150\Omega$  load at a gain of 2. This is a worst case condition. The amplifier is

more stable at higher gains. Alternatively, a small resistor ( $10\Omega$  to  $20\Omega$ ) can be put in series with the output to isolate the capacitive load from the amplifier output. This has the advantage that the amplifier bandwidth is only reduced when the capacitive load is present. The disadvantage is that the gain is a function of the load resistance.

**Power Supplies**

The LT1259/LT1260 will operate from single or split supplies from  $\pm 2\text{V}$  ( $4\text{V}$  total) to  $\pm 15\text{V}$  ( $30\text{V}$  total). It is not necessary to use equal value split supplies, however the offset voltage and inverting input bias current will change. The offset voltage changes about  $500\mu\text{V}$  per volt of supply mismatch. The inverting bias current can change as much as  $5\mu\text{A}$  per volt of supply mismatch though typically, the change is about  $0.1\mu\text{A}$  per volt.

**Slew Rate**

The slew rate of a current feedback amplifier is not independent of the amplifier gain configuration the way slew rate is in a traditional op amp. This is because both the input stage and the output stage have slew rate limitations. In the inverting mode, and for higher gains in the noninverting mode, the signal amplitude between the input pins is small and the overall slew rate is that of the output stage. For gains less than ten in the noninverting mode, the overall slew rate is limited by the input stage.

## APPLICATIONS INFORMATION

The input slew rate of the LT1259/LT1260 is approximately  $270\text{V}/\mu\text{s}$  and is set by internal currents and capacitances. The output slew rate is set by the value of the feedback resistors and internal capacitances. At a gain of 10 with at  $1\text{k}$  feedback resistor and  $\pm 15\text{V}$  supplies, the output slew rate is typically  $1600\text{V}/\mu\text{s}$ . Larger feedback resistors will reduce the slew rate as will lower supply voltages, similar to the way the bandwidth is reduced.

The graph of Maximum Undistorted Output vs Frequency relates the slew rate limitations to sinusoidal input for various gains.

looks like a  $4.4\text{pF}$  capacitor in parallel with a  $75\text{k}$  resistor, excluding feedback resistor effects. These amplifiers are designed to operate with open drain logic: the  $\overline{\text{EN}}$  pins have internal pullups and the amplifiers draw zero current when these pins are high. To activate an amplifier, its  $\overline{\text{EN}}$  pin is pulled to ground (or at least  $2\text{V}$  below the positive supply). The enable pin current is approximately  $60\mu\text{A}$  when activated. Input referred switching transients with no input signal applied are only  $35\text{mV}$  positive and  $80\text{mV}$  negative with  $R_L = 100\Omega$ .

Large-Signal Transient Response,  $A_V = 2$

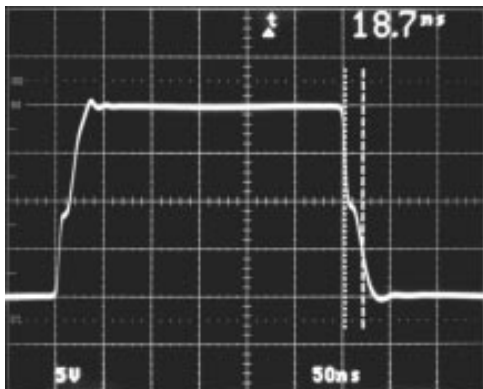

$V_S = \pm 15\text{V}$   $R_L = 400\Omega$   
 $R_F = R_G = 1.6\text{k}$

LT1259/LT1260 • A101

Large-Signal Transient Response,  $A_V = 10$

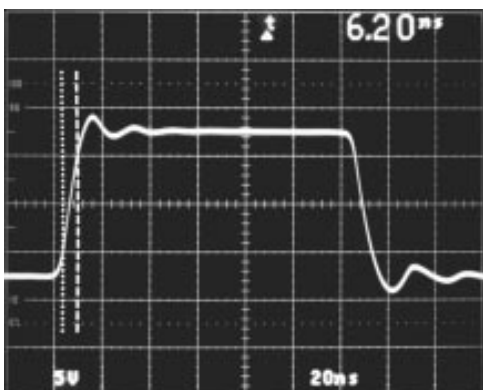

$V_S = \pm 15\text{V}$   $R_G = 110\Omega$   
 $R_F = 1\text{k}$   $R_L = 400\Omega$

LT1259/LT1260 • A102

### Enable/Disable

The LT1259/LT1260 amplifiers have a unique high impedance, zero supply current mode which is controlled by independent  $\overline{\text{EN}}$  pins. When disabled, an amplifier output

Output Switching Transient

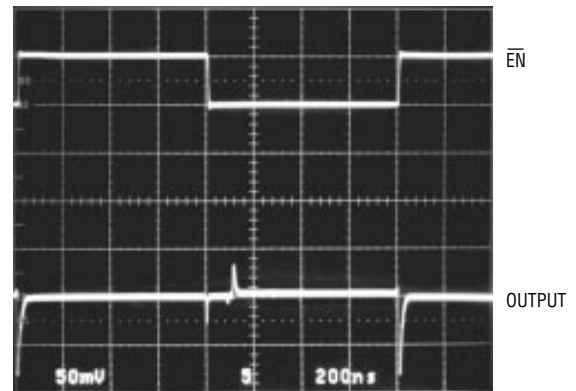

$V_S = \pm 5\text{V}$   $R_F = R_G = 1.6\text{k}$   
 $V_{IN} = 0\text{V}$   $R_L = 100\Omega$

LT1259/LT1260 • A103

The enable/disable times are very fast when driven from standard  $5\text{V}$  logic. The amplifier enables in about  $100\text{ns}$  (50% point to 50% point) while operating on  $\pm 5\text{V}$  supplies. Likewise the disable time is approximately  $40\text{ns}$  (50% point to 50% point) or 75ns to 90% of the final value. The output decay time is set by the output capacitance and load resistor.

Amplifier Enable Time,  $A_V = 10$

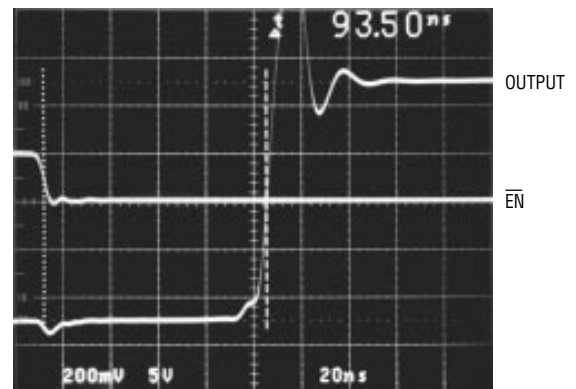

$V_S = \pm 5\text{V}$   $R_F = 1\text{k}$   $R_L = 150\Omega$   
 $V_{IN} = 0.1\text{V}$   $R_G = 110\Omega$

LT1259/LT1260 • A104



## APPLICATIONS INFORMATION

Amplifier Disable Time,  $A_V = 10$

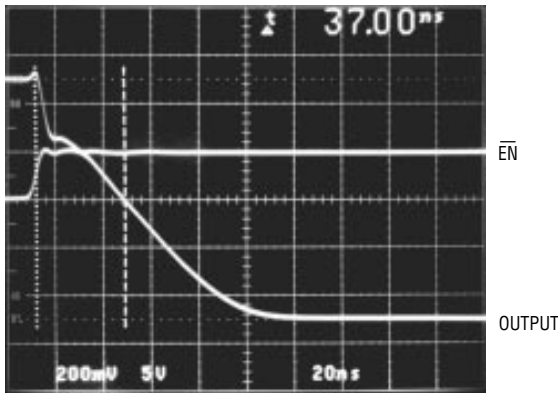

$V_S = \pm 5V$   $R_F = 1k$   $R_L = 150\Omega$  LT1259/LT1260 • A105  
 $V_{IN} = 0.1V$   $R_G = 110\Omega$

Amplifier Enable/Disable Time,  $A_V = 2$

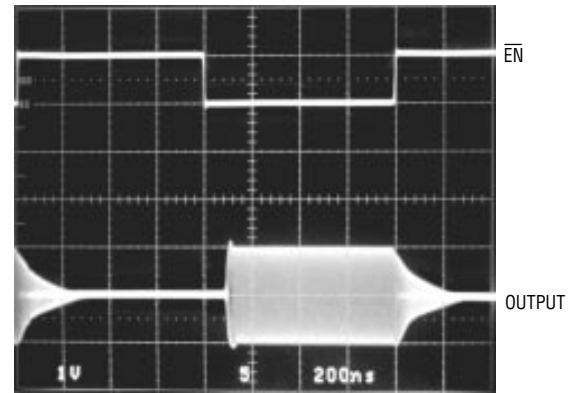

$V_S = \pm 5V$   $R_F = R_G = 1.6k$  LT1259/LT1260 • A106  
 $V_{IN} = 2V_{PP}$  at 2MHz  $R_L = 100\Omega$

### Differential Input Signal Swing

The differential input swing is limited to about  $\pm 6V$  by an ESD protection device connected between the inputs. In normal operation, the differential voltage between the

input pins is small, so this clamp has no effect. In the disabled mode however, the differential swing can be the same as the input swing, and the clamp voltage will set the maximum allowable input voltage.

## TYPICAL APPLICATIONS

### 2-Input Video MUX Cable Driver

The application on the first page shows a low cost, 2-input video MUX cable driver. The scope photo displays the cable output of a 30MHz square wave driving  $150\Omega$ . In this circuit the active amplifier is loaded by  $R_F$  and  $R_G$  of the disabled amplifier, but in this case it only causes a 1.2% gain error. The gain error can be eliminated by

configuring each amplifier as a unity-gain follower. The switching time between channels is 100ns when both  $\overline{EN} A$  and  $\overline{EN} B$  are driven.

2-Input Video MUX Switching Response

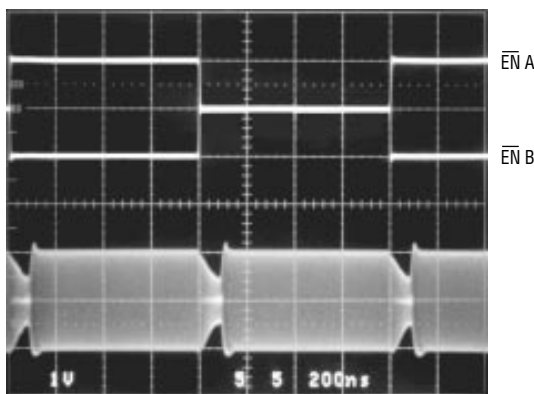

$V_S = \pm 5V$   $R_F = R_G = 1.6k$  LT1259/LT1260 • TA03  
 $V_{IN A} = V_{IN 2} = 2V_{PP}$  at 2MHz  $R_L = 100\Omega$

### 2-Input RGB MUX Cable Driver Demonstration Board

A complete 2-input RGB MUX has been fabricated on PC Demo Board #039A. The board incorporates two LT1260s with outputs summed through  $75\Omega$  back termination resistors as shown in the schematic. There are several things to note about Demo Board #039A:

1. The feedback resistors of the disabled LT1260 load the enabled amplifier and cause a small (1% to 2%) gain error depending on the values of  $R_F$  and  $R_G$ . Configure the amplifiers as unity-gain followers to eliminate this error.
2. The feedback node has minimum trace length connecting  $R_F$  and  $R_G$  to minimize stray capacitance.
3. Ground plane is pulled away from  $R_F$  and  $R_G$  on both sides of the board to minimize stray capacitance.

## TYPICAL APPLICATIONS

4. Capacitors C1 and C6 are optional and only needed to reduce overshoot when EN 1 or EN 2 are activated with a long inductive ground wire.
5. The R, G and B amplifiers have slightly different frequency responses due to different output trace routing to R<sub>F</sub> (between pins 3 and 4). All amplifiers have slightly less bandwidth in PCB #039 than when measured alone as shown in the Typical AC Performance table.
6. Part-to-part variation can change the peaking by  $\pm 0.25\text{dB}$ .

RGB Demo Board All Hostile Crosstalk

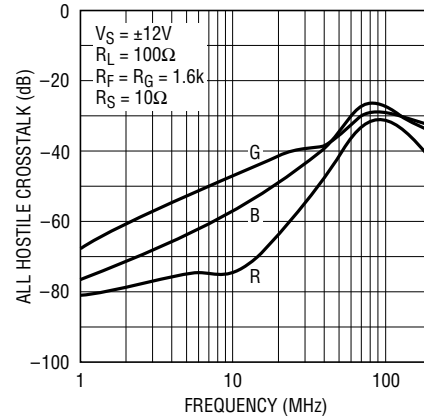

LT1259/60 • TA06

RGB Demo Board Gain vs Frequency

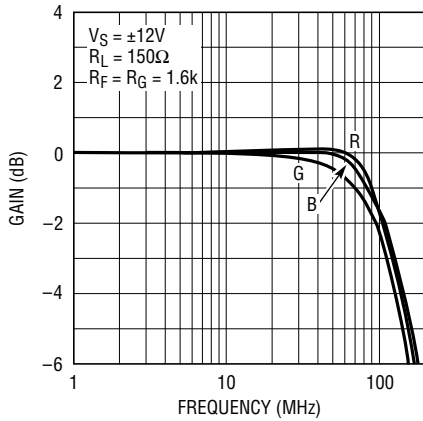

LT1259/60 • TA04

RGB Demo Board Gain vs Frequency

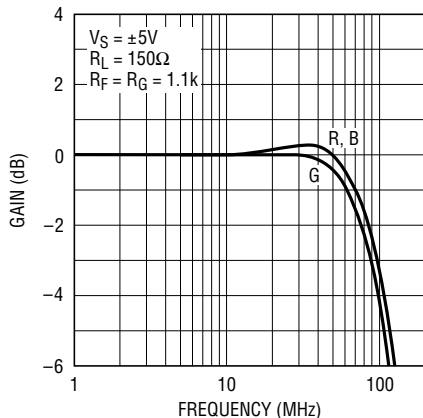

LT1259/60 • TA05

P-DIP PC Board #039

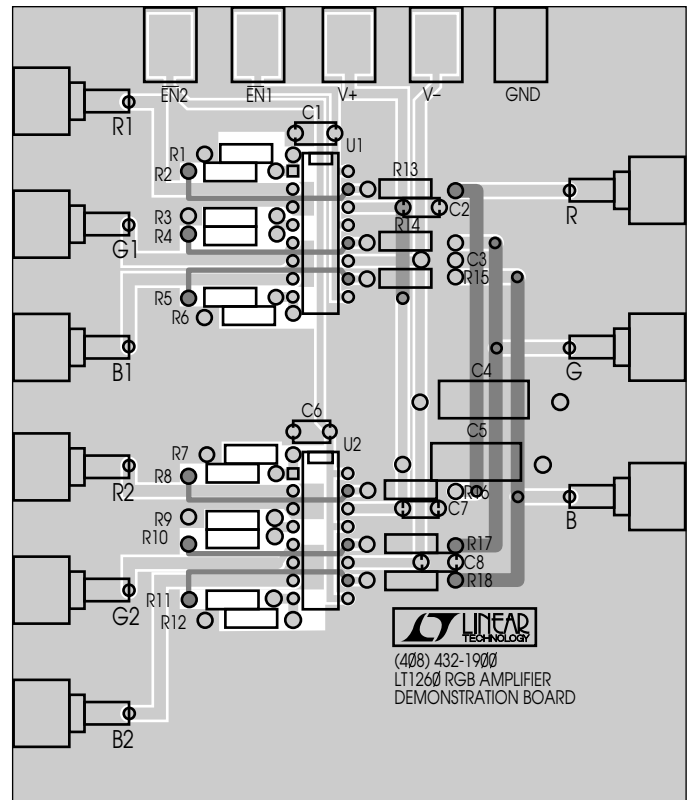

LT1259/60 • TA07

**PACKAGE DESCRIPTION** Dimensions in inches (millimeters) unless otherwise noted.

**N Package**  
**14-Lead PDIP (Narrow 0.300)**  
 (LTC DWG # 05-08-1510)

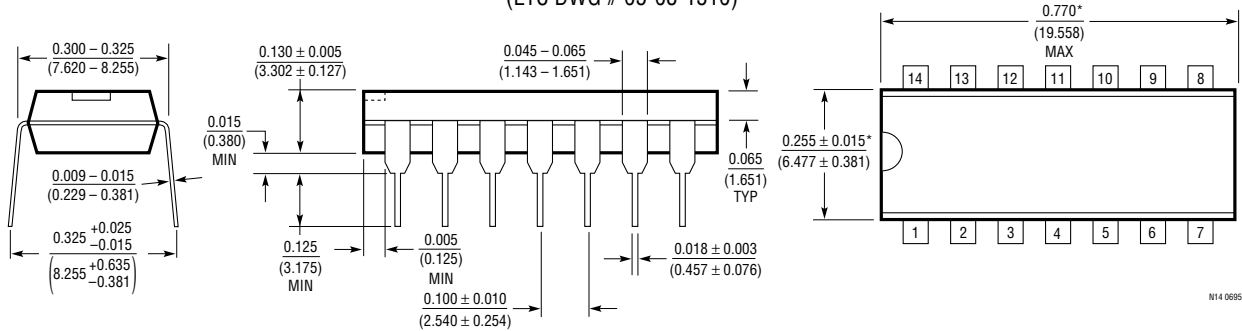

\*THESE DIMENSIONS DO NOT INCLUDE MOLD FLASH OR PROTRUSIONS.  
 MOLD FLASH OR PROTRUSIONS SHALL NOT EXCEED 0.010 INCH (0.254mm)

**N Package**  
**16-Lead PDIP (Narrow 0.300)**  
 (LTC DWG # 05-08-1510)

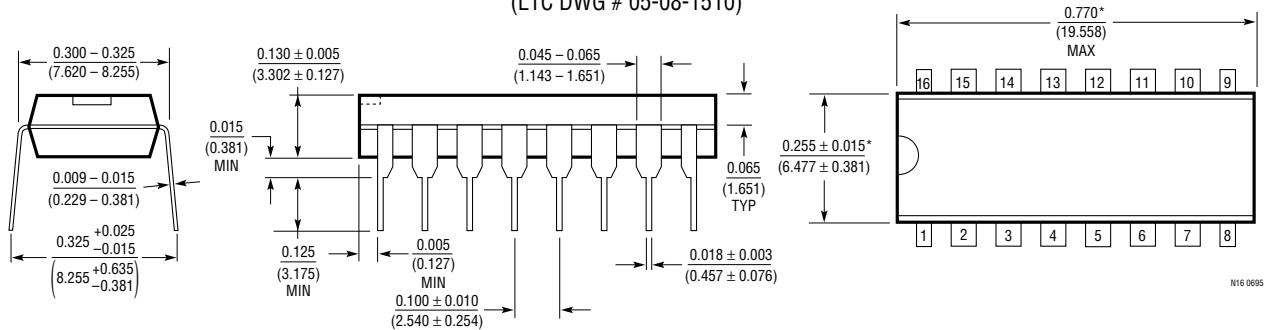

\*THESE DIMENSIONS DO NOT INCLUDE MOLD FLASH OR PROTRUSIONS.  
 MOLD FLASH OR PROTRUSIONS SHALL NOT EXCEED 0.010 INCH (0.254mm)

**S Package**  
**14-Lead Plastic Small Outline (Narrow 0.150)**  
 (LTC DWG # 05-08-1610)

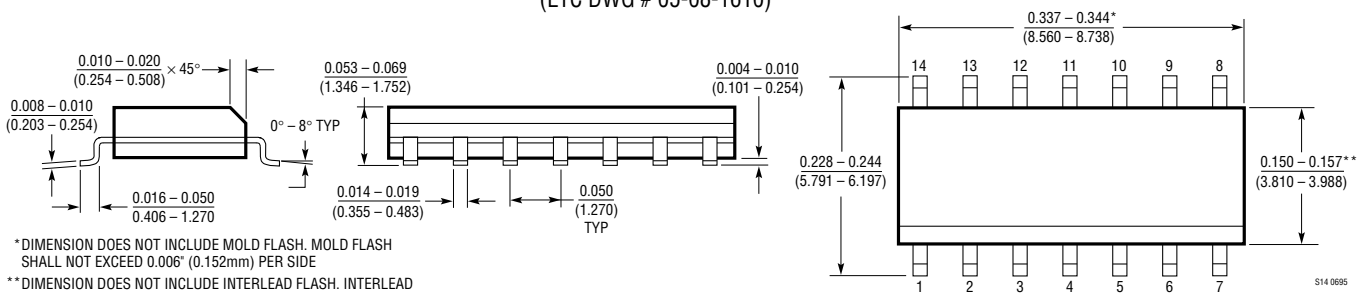

\* DIMENSION DOES NOT INCLUDE MOLD FLASH. MOLD FLASH SHALL NOT EXCEED 0.006" (0.152mm) PER SIDE

\*\* DIMENSION DOES NOT INCLUDE INTERLEAD FLASH. INTERLEAD FLASH SHALL NOT EXCEED 0.010" (0.254mm) PER SIDE

**S Package**  
**16-Lead Plastic Small Outline (Narrow 0.150)**  
 (LTC DWG # 05-08-1610)

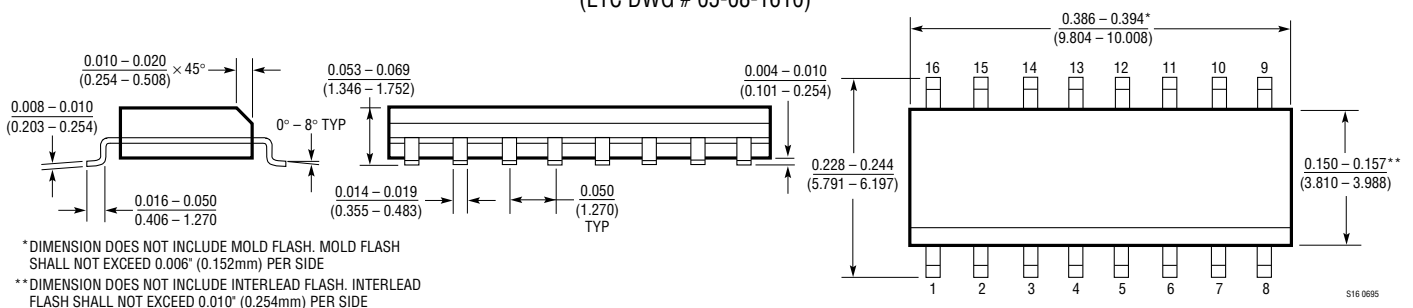

\* DIMENSION DOES NOT INCLUDE MOLD FLASH. MOLD FLASH SHALL NOT EXCEED 0.006" (0.152mm) PER SIDE

\*\* DIMENSION DOES NOT INCLUDE INTERLEAD FLASH. INTERLEAD FLASH SHALL NOT EXCEED 0.010" (0.254mm) PER SIDE

# LT1259/LT1260

## TYPICAL APPLICATION

Demonstration PC Board Schematic #039

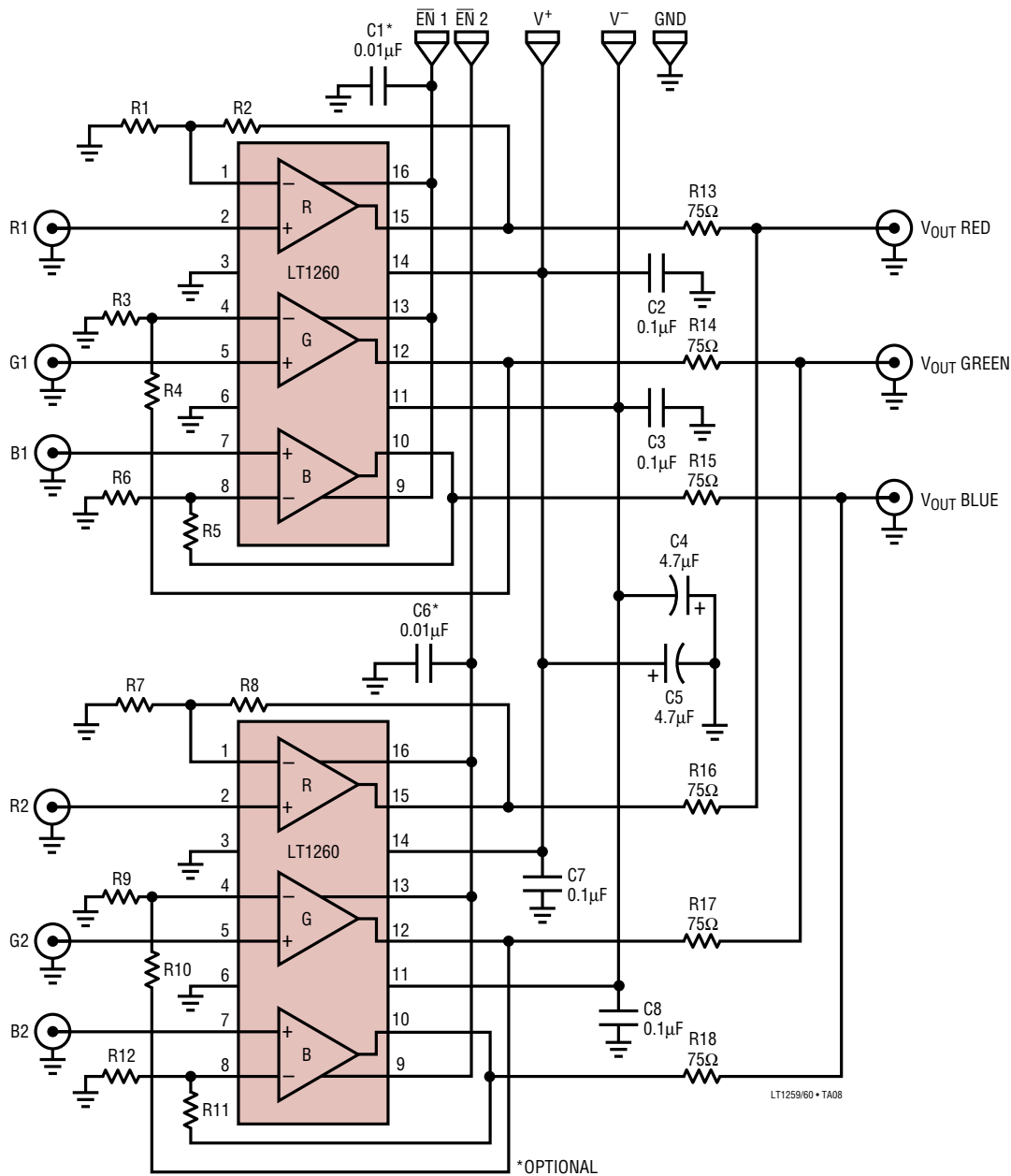

## RELATED PARTS

| PART NUMBER          | DESCRIPTION                                       | COMMENTS  |
|----------------------|---|---|
| LT1203/LT1205        | 150MHz Video Multiplexers                         | 2:1 and Dual 2:1 MUXes with 25ns Switch Time      |
| LT1204               | 4-Input Video MUX with Current Feedback Amplifier | Cascadable Enable 64:1 Multiplexing               |
| LT1227               | 140MHz Current Feedback Amplifier                 | 1100V/ $\mu$ s Slew Rate, Shutdown Mode           |
| LT1252/LT1253/LT1254 | Low Cost Video Amplifiers                         | Single, Dual and Quad Current Feedback Amplifiers |