

**TOSHIBA**

**TA7805,057,06,07,08,09,10,12,15,18,20,24SB**

TOSHIBA BIPOLAR LINEAR INTEGRATED CIRCUIT SILICON MONOLITHIC

**TA7805SB, TA78057SB, TA7806SB, TA7807SB, TA7808SB, TA7809SB  
TA7810SB, TA7812SB, TA7815SB, TA7818SB, TA7820SB, TA7824SB**

**THREE TERMINAL POSITIVE VOLTAGE REGULATORS**

**5 V, 5.7 V, 6 V, 7 V, 8 V, 9 V, 10 V, 12 V, 15 V, 18 V, 20 V, 24 V**

**FEATURES**

- Suitable for CMOS, TTL, the other digital IC's power supply
- Internal thermal overload protection
- Internal short circuit current limiting
- Output current in excess of 1 A
- Package in the plastic case TPL ( $P_D : 1.8 W$ )

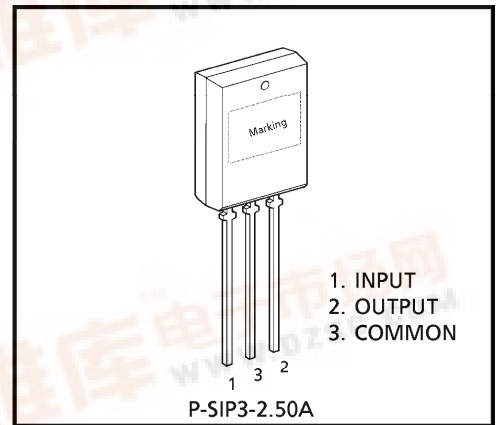

Weight : 1.5 g (Typ.)

**EQUIVALENT CIRCUIT**

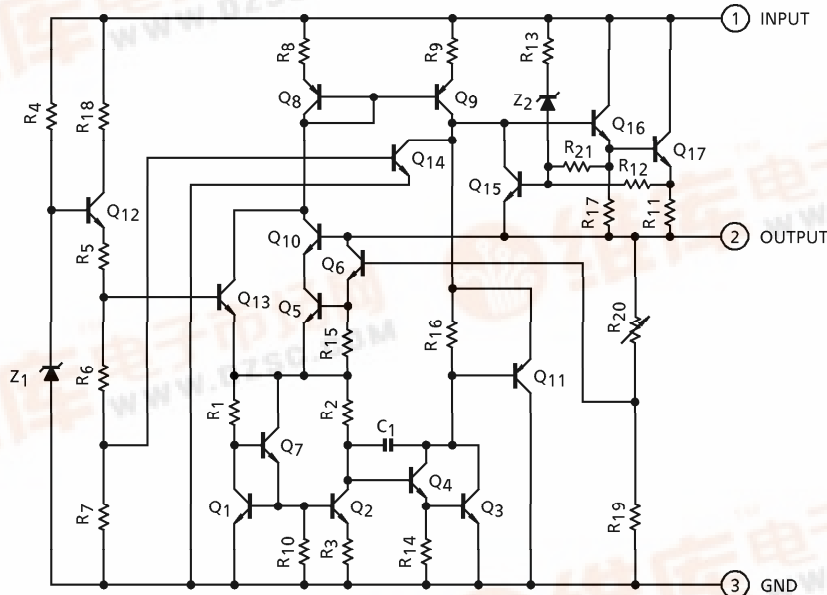

980910EBA1

● TOSHIBA is continually working to improve the quality and the reliability of its products. Nevertheless, semiconductor devices in general can malfunction or fail due to their inherent electrical sensitivity and vulnerability to physical stress. It is the responsibility of the buyer, when utilizing TOSHIBA products, to observe standards of safety, and to avoid situations in which a malfunction or failure of a TOSHIBA product could cause loss of human life, bodily injury or damage to property. In developing your designs, please ensure that TOSHIBA products are used within specified operating ranges as set forth in the most recent products specifications. Also, please keep in mind the precautions and conditions set forth in the TOSHIBA Semiconductor Reliability Handbook.

● The products described in this document are subject to the foreign exchange and foreign trade laws.

● The information contained herein is presented only as a guide for the applications of our products. No responsibility is assumed by TOSHIBA CORPORATION for any infringements of intellectual property or other rights of the third parties which may result from its use. No license is granted by implication or otherwise under any intellectual property or other rights of TOSHIBA CORPORATION or others.

● The information contained herein is subject to change without notice.



**MAXIMUM RATINGS (Ta = 25°C)**

CHARACTERISTIC		SYMBOL	RATING	UNIT
Input Voltage	TA7805SB	V <sub>IN</sub>	35	V
	TA78057SB			
	TA7806SB			
	TA7807SB			
	TA7808SB			
	TA7809SB			
	TA7810SB			
	TA7812SB			
	TA7815SB			
	TA7818SB		40	
	TA7820SB			
	TA7824SB			
Power Dissipation	(Ta = 25°C)	P <sub>D</sub>	1.8	W
Operating Temperature		T <sub>opr</sub>	- 30~85	°C
Storage Temperature		T <sub>stg</sub>	- 55~150	°C
Junction Temperature		T <sub>j</sub>	150	°C
Thermal Resistance		R <sub>th(j-a)</sub>	69.4	°C / W

TA7805SB

**ELECTRICAL CHARACTERISTICS**

(Unless otherwise specified,  $V_{IN} = 10\text{ V}$ ,  $I_{OUT} = 500\text{ mA}$ ,  $0^\circ\text{C} \leq T_j \leq 125^\circ\text{C}$ )

CHARACTERISTIC	SYMBOL	TEST CIR-CUIT	TEST CONDITION	MIN.	TYP.	MAX.	UNIT	
Output Voltage	$V_{OUT}$	1	$T_j = 25^\circ\text{C}$ , $I_{OUT} = 100\text{ mA}$	4.8	5.0	5.2	V	
Line Regulation	Reg·line	1	$T_j = 25^\circ\text{C}$	$7.0\text{ V} \leq V_{IN} \leq 25\text{ V}$	—	3	100	mV
				$8.0\text{ V} \leq V_{IN} \leq 12\text{ V}$	—	1	50	
Load Regulation	Reg·load	1	$T_j = 25^\circ\text{C}$	$5\text{ mA} \leq I_{OUT} \leq 1.4\text{ A}$	—	15	100	mV
				$250\text{ mA} \leq I_{OUT} \leq 750\text{ mA}$	—	5	50	
Output Voltage	$V_{OUT}$	1	$T_j = 25^\circ\text{C}$ $7.0\text{ V} \leq V_{IN} \leq 20\text{ V}$ $5.0\text{ mA} \leq I_{OUT} \leq 1.0\text{ A}$	4.75	—	5.25	V	
Quiescent Current	$I_B$	1	$T_j = 25^\circ\text{C}$ , $I_{OUT} = 5\text{ mA}$	—	4.2	8.0	mA	
Quiescent Current Change	$\Delta I_B$	1	$7.0\text{ V} \leq V_{IN} \leq 25\text{ V}$ , $I_{OUT} = 5\text{ mA}$ , $T_j = 25^\circ\text{C}$	—	—	1.3	mA	
Output Noise Voltage	$V_{NO}$	2	$T_a = 25^\circ\text{C}$ , $10\text{ Hz} \leq f \leq 100\text{ kHz}$ $I_{OUT} = 50\text{ mA}$	—	50	—	$\mu\text{V}_{rms}$	
Ripple Rejection	R.R.	3	$f = 120\text{ Hz}$ , $8.0\text{ V} \leq V_{IN} \leq 18\text{ V}$ $I_{OUT} = 50\text{ mA}$ , $T_j = 25^\circ\text{C}$	62	78	—	dB	
Dropout Voltage	$V_D$	1	$I_{OUT} = 1.0\text{ A}$ , $T_j = 25^\circ\text{C}$	—	2.0	—	V	
Short Circuit Current Limit	$I_{SC}$	1	$T_j = 25^\circ\text{C}$	—	1.6	—	A	
Average Temperature Coefficient of Output Voltage	$T_{CVO}$	1	$I_{OUT} = 5\text{ mA}$	—	-0.6	—	mV/°C	

TA78057SB

**ELECTRICAL CHARACTERISTICS**

(Unless otherwise specified,  $V_{IN} = 10.7\text{ V}$ ,  $I_{OUT} = 500\text{ mA}$ ,  $0^\circ\text{C} \leq T_j \leq 125^\circ\text{C}$ )

CHARACTERISTIC	SYMBOL	TEST CIR-CUIT	TEST CONDITION	MIN.	TYP.	MAX.	UNIT	
Output Voltage	$V_{OUT}$	1	$T_j = 25^\circ\text{C}$ , $I_{OUT} = 100\text{ mA}$	5.47	5.7	5.93	V	
Line Regulation	Reg·line	1	$T_j = 25^\circ\text{C}$	$7.7\text{ V} \leq V_{IN} \leq 25\text{ V}$	—	4	110	mV
				$8.7\text{ V} \leq V_{IN} \leq 12.7\text{ V}$	—	2	55	
Load Regulation	Reg·load	1	$T_j = 25^\circ\text{C}$	$5\text{ mA} \leq I_{OUT} \leq 1.4\text{ A}$	—	15	110	mV
				$250\text{ mA} \leq I_{OUT} \leq 750\text{ mA}$	—	5	55	
Output Voltage	$V_{OUT}$	1	$T_j = 25^\circ\text{C}$ $7.7\text{ V} \leq V_{IN} \leq 20.7\text{ V}$ $5.0\text{ mA} \leq I_{OUT} \leq 1.0\text{ A}$	5.42	—	5.98	V	
Quiescent Current	$I_B$	1	$T_j = 25^\circ\text{C}$ , $I_{OUT} = 5\text{ mA}$	—	4.3	8.0	mA	
Quiescent Current Change	$\Delta I_B$	1	$7.7\text{ V} \leq V_{IN} \leq 25\text{ V}$ , $I_{OUT} = 5\text{ mA}$ , $T_j = 25^\circ\text{C}$	—	—	1.3	mA	
Output Noise Voltage	$V_{NO}$	2	$T_a = 25^\circ\text{C}$ , $10\text{ Hz} \leq f \leq 100\text{ kHz}$ $I_{OUT} = 50\text{ mA}$	—	55	—	$\mu\text{V}_{rms}$	
Ripple Rejection	R.R.	3	$f = 120\text{ Hz}$ , $8.8\text{ V} \leq V_{IN} \leq 18.8\text{ V}$ $I_{OUT} = 50\text{ mA}$ , $T_j = 25^\circ\text{C}$	62	77	—	dB	
Dropout Voltage	$V_D$	1	$I_{OUT} = 1.0\text{ A}$ , $T_j = 25^\circ\text{C}$	—	2.0	—	V	
Short Circuit Current Limit	$I_{SC}$	1	$T_j = 25^\circ\text{C}$	—	1.5	—	A	
Average Temperature Coefficient of Output Voltage	$T_{CVO}$	1	$I_{OUT} = 5\text{ mA}$	—	-0.7	—	$\text{mV}/^\circ\text{C}$	

TA7806SB

**ELECTRICAL CHARACTERISTICS**

(Unless otherwise specified,  $V_{IN} = 11\text{ V}$ ,  $I_{OUT} = 500\text{ mA}$ ,  $0^\circ\text{C} \leq T_j \leq 125^\circ\text{C}$ .)

CHARACTERISTIC	SYMBOL	TEST CIR-CUIT	TEST CONDITION	MIN.	TYP.	MAX.	UNIT	
Output Voltage	$V_{OUT}$	1	$T_j = 25^\circ\text{C}$ , $I_{OUT} = 100\text{ mA}$	5.75	6.0	6.25	V	
Line Regulation	Reg·line	1	$T_j = 25^\circ\text{C}$	$8.0\text{ V} \leq V_{IN} \leq 25\text{ V}$	—	4	120	mV
				$9\text{ V} \leq V_{IN} \leq 13\text{ V}$	—	2	60	
Load Regulation	Reg·load	1	$T_j = 25^\circ\text{C}$	$5\text{ mA} \leq I_{OUT} \leq 1.4\text{ A}$	—	15	120	mV
				$250\text{ mA} \leq I_{OUT} \leq 750\text{ mA}$	—	5	60	
Output Voltage	$V_{OUT}$	1	$T_j = 25^\circ\text{C}$ $8\text{ V} \leq V_{IN} \leq 21\text{ V}$ $5.0\text{ mA} \leq I_{OUT} \leq 1.0\text{ A}$	5.7	—	6.3	V	
Quiescent Current	$I_B$	1	$T_j = 25^\circ\text{C}$ , $I_{OUT} = 5\text{ mA}$	—	4.3	8.0	mA	
Quiescent Current Change	$\Delta I_B$	1	$8.0\text{ V} \leq V_{IN} \leq 25\text{ V}$ , $I_{OUT} = 5\text{ mA}$ , $T_j = 25^\circ\text{C}$	—	—	1.3	mA	
Output Noise Voltage	$V_{NO}$	2	$T_a = 25^\circ\text{C}$ , $10\text{ Hz} \leq f \leq 100\text{ kHz}$ $I_{OUT} = 50\text{ mA}$	—	55	—	$\mu\text{V}_{rms}$	
Ripple Rejection	R.R.	3	$f = 120\text{ Hz}$ , $9\text{ V} \leq V_{IN} \leq 19\text{ V}$ $I_{OUT} = 50\text{ mA}$ , $T_j = 25^\circ\text{C}$	61	77	—	dB	
Dropout Voltage	$V_D$	1	$I_{OUT} = 1.0\text{ A}$ , $T_j = 25^\circ\text{C}$	—	2.0	—	V	
Short Circuit Current Limit	$I_{SC}$	1	$T_j = 25^\circ\text{C}$	—	1.5	—	A	
Average Temperature Coefficient of Output Voltage	$T_{CVO}$	1	$I_{OUT} = 5\text{ mA}$	—	-0.7	—	$\text{mV}/^\circ\text{C}$	

TA7807SB

**ELECTRICAL CHARACTERISTICS**

(Unless otherwise specified,  $V_{IN} = 12\text{ V}$ ,  $I_{OUT} = 500\text{ mA}$ ,  $0^\circ\text{C} \leq T_j \leq 125^\circ\text{C}$ )

CHARACTERISTIC	SYMBOL	TEST CIR-CUIT	TEST CONDITION	MIN.	TYP.	MAX.	UNIT	
Output Voltage	$V_{OUT}$	1	$T_j = 25^\circ\text{C}$ , $I_{OUT} = 100\text{ mA}$	6.72	7.0	7.28	V	
Line Regulation	Reg·line	1	$T_j = 25^\circ\text{C}$	$9\text{ V} \leq V_{IN} \leq 25\text{ V}$	—	5	140	mV
				$10\text{ V} \leq V_{IN} \leq 14\text{ V}$	—	2	70	
Load Regulation	Reg·load	1	$T_j = 25^\circ\text{C}$	$5\text{ mA} \leq I_{OUT} \leq 1.4\text{ A}$	—	15	140	mV
				$250\text{ mA} \leq I_{OUT} \leq 750\text{ mA}$	—	5	70	
Output Voltage	$V_{OUT}$	1	$T_j = 25^\circ\text{C}$ $9\text{ V} \leq V_{IN} \leq 22\text{ V}$ $5.0\text{ mA} \leq I_{OUT} \leq 1.0\text{ A}$	6.65	—	7.35	V	
Quiescent Current	$I_B$	1	$T_j = 25^\circ\text{C}$ , $I_{OUT} = 5\text{ mA}$	—	4.3	8.0	mA	
Quiescent Current Change	$\Delta I_B$	1	$9\text{ V} \leq V_{IN} \leq 25\text{ V}$ , $I_{OUT} = 5\text{ mA}$ , $T_j = 25^\circ\text{C}$	—	—	1.3	mA	
Output Noise Voltage	$V_{NO}$	2	$T_a = 25^\circ\text{C}$ , $10\text{ Hz} \leq f \leq 100\text{ kHz}$ $I_{OUT} = 50\text{ mA}$	—	60	—	$\mu\text{V}_{rms}$	
Ripple Rejection	R.R.	3	$f = 120\text{ Hz}$ , $10\text{ V} \leq V_{IN} \leq 20\text{ V}$ $I_{OUT} = 50\text{ mA}$ , $T_j = 25^\circ\text{C}$	59	75	—	dB	
Dropout Voltage	$V_D$	1	$I_{OUT} = 1.0\text{ A}$ , $T_j = 25^\circ\text{C}$	—	2.0	—	V	
Short Circuit Current Limit	$I_{SC}$	1	$T_j = 25^\circ\text{C}$	—	1.3	—	A	
Average Temperature Coefficient of Output Voltage	$T_{CVO}$	1	$I_{OUT} = 5\text{ mA}$	—	-0.8	—	$\text{mV}/^\circ\text{C}$	

TA7808SB

**ELECTRICAL CHARACTERISTICS**

(Unless otherwise specified,  $V_{IN} = 14\text{ V}$ ,  $I_{OUT} = 500\text{ mA}$ ,  $0^\circ\text{C} \leq T_j \leq 125^\circ\text{C}$ )

CHARACTERISTIC	SYMBOL	TEST CIR-CUIT	TEST CONDITION	MIN.	TYP.	MAX.	UNIT	
Output Voltage	$V_{OUT}$	1	$T_j = 25^\circ\text{C}$ , $I_{OUT} = 100\text{ mA}$	7.7	8.0	8.3	V	
Line Regulation	Reg·line	1	$T_j = 25^\circ\text{C}$	$10.5\text{ V} \leq V_{IN} \leq 25\text{ V}$	—	6	160	mV
				$11\text{ V} \leq V_{IN} \leq 17\text{ V}$	—	2	80	
Load Regulation	Reg·load	1	$T_j = 25^\circ\text{C}$	$5\text{ mA} \leq I_{OUT} \leq 1.4\text{ A}$	—	12	160	mV
				$250\text{ mA} \leq I_{OUT} \leq 750\text{ mA}$	—	4	80	
Output Voltage	$V_{OUT}$	1	$T_j = 25^\circ\text{C}$ $10.5\text{ V} \leq V_{IN} \leq 23\text{ V}$ $5.0\text{ mA} \leq I_{OUT} \leq 1.0\text{ A}$	7.6	—	8.4	V	
Quiescent Current	$I_B$	1	$T_j = 25^\circ\text{C}$ , $I_{OUT} = 5\text{ mA}$	—	4.3	8.0	mA	
Quiescent Current Change	$\Delta I_B$	1	$10.5\text{ V} \leq V_{IN} \leq 25\text{ V}$ , $I_{OUT} = 5\text{ mA}$ , $T_j = 25^\circ\text{C}$	—	—	1.0	mA	
Output Noise Voltage	$V_{NO}$	2	$T_a = 25^\circ\text{C}$ , $10\text{ Hz} \leq f \leq 100\text{ kHz}$ $I_{OUT} = 50\text{ mA}$	—	70	—	$\mu\text{V}_{rms}$	
Ripple Rejection	R.R.	3	$f = 120\text{ Hz}$ , $11.5\text{ V} \leq V_{IN} \leq 21.5\text{ V}$ $I_{OUT} = 50\text{ mA}$ , $T_j = 25^\circ\text{C}$	58	74	—	dB	
Dropout Voltage	$V_D$	1	$I_{OUT} = 1.0\text{ A}$ , $T_j = 25^\circ\text{C}$	—	2.0	—	V	
Short Circuit Current Limit	$I_{SC}$	1	$T_j = 25^\circ\text{C}$	—	1.1	—	A	
Average Temperature Coefficient of Output Voltage	$T_{CVO}$	1	$I_{OUT} = 5\text{ mA}$	—	-1.0	—	$\text{mV}/^\circ\text{C}$	

TA7809SB

**ELECTRICAL CHARACTERISTICS**

(Unless otherwise specified,  $V_{IN} = 15\text{ V}$ ,  $I_{OUT} = 500\text{ mA}$ ,  $0^\circ\text{C} \leq T_j \leq 125^\circ\text{C}$ )

CHARACTERISTIC	SYMBOL	TEST CIR-CUIT	TEST CONDITION	MIN.	TYP.	MAX.	UNIT	
Output Voltage	$V_{OUT}$	1	$T_j = 25^\circ\text{C}$ , $I_{OUT} = 100\text{ mA}$	8.64	9.0	9.36	V	
Line Regulation	Reg·line	1	$T_j = 25^\circ\text{C}$	$11.5\text{ V} \leq V_{IN} \leq 26\text{ V}$	—	7	180	mV
				$13\text{ V} \leq V_{IN} \leq 19\text{ V}$	—	2.5	90	
Load Regulation	Reg·load	1	$T_j = 25^\circ\text{C}$	$5\text{ mA} \leq I_{OUT} \leq 1.4\text{ A}$	—	12	180	mV
				$250\text{ mA} \leq I_{OUT} \leq 750\text{ mA}$	—	4	90	
Output Voltage	$V_{OUT}$	1	$T_j = 25^\circ\text{C}$ $11.5\text{ V} \leq V_{IN} \leq 24\text{ V}$ $5.0\text{ mA} \leq I_{OUT} \leq 1.0\text{ A}$	8.55	—	9.45	V	
Quiescent Current	$I_B$	1	$T_j = 25^\circ\text{C}$ , $I_{OUT} = 5\text{ mA}$	—	4.3	8.0	mA	
Quiescent Current Change	$\Delta I_B$	1	$11.5\text{ V} \leq V_{IN} \leq 26\text{ V}$ , $I_{OUT} = 5\text{ mA}$ , $T_j = 25^\circ\text{C}$	—	—	1.0	mA	
Output Noise Voltage	$V_{NO}$	2	$T_a = 25^\circ\text{C}$ , $10\text{ Hz} \leq f \leq 100\text{ kHz}$ $I_{OUT} = 50\text{ mA}$	—	75	—	$\mu\text{V}_{rms}$	
Ripple Rejection	R.R.	3	$f = 120\text{ Hz}$ , $12.5\text{ V} \leq V_{IN} \leq 22.5\text{ V}$ $I_{OUT} = 50\text{ mA}$ , $T_j = 25^\circ\text{C}$	56	72	—	dB	
Dropout Voltage	$V_D$	1	$I_{OUT} = 1.0\text{ A}$ , $T_j = 25^\circ\text{C}$	—	2.0	—	V	
Short Circuit Current Limit	$I_{SC}$	1	$T_j = 25^\circ\text{C}$	—	1.0	—	A	
Average Temperature Coefficient of Output Voltage	$T_{CVO}$	1	$I_{OUT} = 5\text{ mA}$	—	-1.1	—	$\text{mV}/^\circ\text{C}$	



TA7810SB

**ELECTRICAL CHARACTERISTICS**

(Unless otherwise specified,  $V_{IN} = 16\text{ V}$ ,  $I_{OUT} = 500\text{ mA}$ ,  $0^\circ\text{C} \leq T_j \leq 125^\circ\text{C}$ )

CHARACTERISTIC	SYMBOL	TEST CIR-CUIT	TEST CONDITION	MIN.	TYP.	MAX.	UNIT	
Output Voltage	$V_{OUT}$	1	$T_j = 25^\circ\text{C}$ , $I_{OUT} = 100\text{ mA}$	9.6	10.0	10.4	V	
Line Regulation	Reg·line	1	$T_j = 25^\circ\text{C}$	$12.5\text{ V} \leq V_{IN} \leq 27\text{ V}$	—	8	200	mV
				$14\text{ V} \leq V_{IN} \leq 20\text{ V}$	—	2.5	100	
Load Regulation	Reg·load	1	$T_j = 25^\circ\text{C}$	$5\text{ mA} \leq I_{OUT} \leq 1.4\text{ A}$	—	12	200	mV
				$250\text{ mA} \leq I_{OUT} \leq 750\text{ mA}$	—	4	100	
Output Voltage	$V_{OUT}$	1	$T_j = 25^\circ\text{C}$ $12.5\text{ V} \leq V_{IN} \leq 25\text{ V}$ $5.0\text{ mA} \leq I_{OUT} \leq 1.0\text{ A}$	9.5	—	10.5	V	
Quiescent Current	$I_B$	1	$T_j = 25^\circ\text{C}$ , $I_{OUT} = 5\text{ mA}$	—	4.3	8.0	mA	
Quiescent Current Change	$\Delta I_B$	1	$12.5\text{ V} \leq V_{IN} \leq 27\text{ V}$ , $I_{OUT} = 5\text{ mA}$ , $T_j = 25^\circ\text{C}$	—	—	1.0	mA	
Output Noise Voltage	$V_{NO}$	2	$T_a = 25^\circ\text{C}$ , $10\text{ Hz} \leq f \leq 100\text{ kHz}$ $I_{OUT} = 50\text{ mA}$	—	80	—	$\mu\text{V}_{rms}$	
Ripple Rejection	R.R.	3	$f = 120\text{ Hz}$ , $13.5\text{ V} \leq V_{IN} \leq 23.5\text{ V}$ $I_{OUT} = 50\text{ mA}$ , $T_j = 25^\circ\text{C}$	55	72	—	dB	
Dropout Voltage	$V_D$	1	$I_{OUT} = 1.0\text{ A}$ , $T_j = 25^\circ\text{C}$	—	2.0	—	V	
Short Circuit Current Limit	$I_{SC}$	1	$T_j = 25^\circ\text{C}$	—	0.9	—	A	
Average Temperature Coefficient of Output Voltage	$T_{CVO}$	1	$I_{OUT} = 5\text{ mA}$	—	-1.3	—	$\text{mV}/^\circ\text{C}$	

TA7812SB

**ELECTRICAL CHARACTERISTICS**

(Unless otherwise specified,  $V_{IN} = 19\text{ V}$ ,  $I_{OUT} = 500\text{ mA}$ ,  $0^\circ\text{C} \leq T_j \leq 125^\circ\text{C}$ )

CHARACTERISTIC	SYMBOL	TEST CIR-CUIT	TEST CONDITION	MIN.	TYP.	MAX.	UNIT	
Output Voltage	$V_{OUT}$	1	$T_j = 25^\circ\text{C}$ , $I_{OUT} = 100\text{ mA}$	11.5	12.0	12.5	V	
Line Regulation	Reg·line	1	$T_j = 25^\circ\text{C}$	$14.5\text{ V} \leq V_{IN} \leq 30\text{ V}$	—	10	240	mV
				$16\text{ V} \leq V_{IN} = 22\text{ V}$	—	3	120	
Load Regulation	Reg·load	1	$T_j = 25^\circ\text{C}$	$5\text{ mA} \leq I_{OUT} \leq 1.4\text{ A}$	—	12	240	mV
				$250\text{ mA} \leq I_{OUT} \leq 750\text{ mA}$	—	4	120	
Output Voltage	$V_{OUT}$	1	$T_j = 25^\circ\text{C}$ $14.5\text{ V} \leq V_{IN} \leq 27\text{ V}$ $5.0\text{ mA} \leq I_{OUT} \leq 1.0\text{ A}$	11.4	—	12.6	V	
Quiescent Current	$I_B$	1	$T_j = 25^\circ\text{C}$ , $I_{OUT} = 5\text{ mA}$	—	4.3	8.0	mA	
Quiescent Current Change	$\Delta I_B$	1	$14.5\text{ V} \leq V_{IN} \leq 30\text{ V}$ , $I_{OUT} = 5\text{ mA}$ , $T_j = 25^\circ\text{C}$	—	—	1.0	mA	
Output Noise Voltage	$V_{NO}$	2	$T_a = 25^\circ\text{C}$ , $10\text{ Hz} \leq f \leq 100\text{ kHz}$ $I_{OUT} = 50\text{ mA}$	—	90	—	$\mu\text{V}_{rms}$	
Ripple Rejection	R.R.	3	$f = 120\text{ Hz}$ , $15\text{ V} \leq V_{IN} \leq 25\text{ V}$ $I_{OUT} = 50\text{ mA}$ , $T_j = 25^\circ\text{C}$	55	71	—	dB	
Dropout Voltage	$V_D$	1	$I_{OUT} = 1.0\text{ A}$ , $T_j = 25^\circ\text{C}$	—	2.0	—	V	
Short Circuit Current Limit	$I_{SC}$	1	$T_j = 25^\circ\text{C}$	—	0.7	—	A	
Average Temperature Coefficient of Output Voltage	$T_{CVO}$	1	$I_{OUT} = 5\text{ mA}$	—	-1.6	—	$\text{mV}/^\circ\text{C}$	

TA7815SB

**ELECTRICAL CHARACTERISTICS**

(Unless otherwise specified,  $V_{IN} = 23\text{ V}$ ,  $I_{OUT} = 500\text{ mA}$ ,  $0^\circ\text{C} \leq T_j \leq 125^\circ\text{C}$ )

CHARACTERISTIC	SYMBOL	TEST CIR-CUIT	TEST CONDITION	MIN.	TYP.	MAX.	UNIT	
Output Voltage	$V_{OUT}$	1	$T_j = 25^\circ\text{C}$ , $I_{OUT} = 100\text{ mA}$	14.4	15.0	15.6	V	
Line Regulation	Reg·line	1	$T_j = 25^\circ\text{C}$	$17.5\text{ V} \leq V_{IN} \leq 30\text{ V}$	—	11	300	mV
				$20\text{ V} \leq V_{IN} \leq 26\text{ V}$	—	3	150	
Load Regulation	Reg·load	1	$T_j = 25^\circ\text{C}$	$5\text{ mA} \leq I_{OUT} \leq 1.4\text{ A}$	—	12	300	mV
				$250\text{ mA} \leq I_{OUT} \leq 750\text{ mA}$	—	4	150	
Output Voltage	$V_{OUT}$	1	$T_j = 25^\circ\text{C}$ $17.5\text{ V} \leq V_{IN} \leq 30\text{ V}$ $5.0\text{ mA} \leq I_{OUT} \leq 1.0\text{ A}$	14.25	—	15.75	V	
Quiescent Current	$I_B$	1	$T_j = 25^\circ\text{C}$ , $I_{OUT} = 5\text{ mA}$	—	4.4	8.0	mA	
Quiescent Current Change	$\Delta I_B$	1	$17.5\text{ V} \leq V_{IN} \leq 30\text{ V}$ , $I_{OUT} = 5\text{ mA}$ , $T_j = 25^\circ\text{C}$	—	—	1.0	mA	
Output Noise Voltage	$V_{NO}$	2	$T_a = 25^\circ\text{C}$ , $10\text{ Hz} \leq f \leq 100\text{ kHz}$ $I_{OUT} = 50\text{ mA}$	—	110	—	$\mu\text{V}_{rms}$	
Ripple Rejection	R.R.	3	$f = 120\text{ Hz}$ , $18.5\text{ V} \leq V_{IN} \leq 28.5\text{ V}$ $I_{OUT} = 50\text{ mA}$ , $T_j = 25^\circ\text{C}$	54	70	—	dB	
Dropout Voltage	$V_D$	1	$I_{OUT} = 1.0\text{ A}$ , $T_j = 25^\circ\text{C}$	—	2.0	—	V	
Short Circuit Current Limit	$I_{SC}$	1	$T_j = 25^\circ\text{C}$	—	0.5	—	A	
Average Temperature Coefficient of Output Voltage	$T_{CVO}$	1	$I_{OUT} = 5\text{ mA}$	—	-2.0	—	mV/°C	

TA7818SB

**ELECTRICAL CHARACTERISTICS**

(Unless otherwise specified,  $V_{IN} = 27\text{ V}$ ,  $I_{OUT} = 500\text{ mA}$ ,  $0^\circ\text{C} \leq T_j \leq 125^\circ\text{C}$ )

CHARACTERISTIC	SYMBOL	TEST CIR-CUIT	TEST CONDITION	MIN.	TYP.	MAX.	UNIT	
Output Voltage	$V_{OUT}$	1	$T_j = 25^\circ\text{C}$ , $I_{OUT} = 100\text{ mA}$	17.3	18.0	18.7	V	
Line Regulation	Reg·line	1	$T_j = 25^\circ\text{C}$	$21\text{ V} \leq V_{IN} \leq 33\text{ V}$	—	13	360	mV
				$24\text{ V} \leq V_{IN} \leq 30\text{ V}$	—	4	180	
Load Regulation	Reg·load	1	$T_j = 25^\circ\text{C}$	$5\text{ mA} \leq I_{OUT} \leq 1.4\text{ A}$	—	12	360	mV
				$250\text{ mA} \leq I_{OUT} \leq 750\text{ mA}$	—	4	180	
Output Voltage	$V_{OUT}$	1	$T_j = 25^\circ\text{C}$ $21\text{ V} \leq V_{IN} \leq 33\text{ V}$ $5.0\text{ mA} \leq I_{OUT} \leq 1.0\text{ A}$	17.1	—	18.9	V	
Quiescent Current	$I_B$	1	$T_j = 25^\circ\text{C}$ , $I_{OUT} = 5\text{ mA}$	—	4.5	8.0	mA	
Quiescent Current Change	$\Delta I_B$	1	$21\text{ V} \leq V_{IN} \leq 33\text{ V}$ , $I_{OUT} = 5\text{ mA}$ , $T_j = 25^\circ\text{C}$	—	—	1.0	mA	
Output Noise Voltage	$V_{NO}$	2	$T_a = 25^\circ\text{C}$ , $10\text{ Hz} \leq f \leq 100\text{ kHz}$ $I_{OUT} = 50\text{ mA}$	—	125	—	$\mu\text{V}_{rms}$	
Ripple Rejection	R.R.	3	$f = 120\text{ Hz}$ , $22\text{ V} \leq V_{IN} \leq 32\text{ V}$ $I_{OUT} = 50\text{ mA}$ , $T_j = 25^\circ\text{C}$	52	68	—	dB	
Dropout Voltage	$V_D$	1	$I_{OUT} = 1.0\text{ A}$ , $T_j = 25^\circ\text{C}$	—	2.0	—	V	
Short Circuit Current Limit	$I_{SC}$	1	$T_j = 25^\circ\text{C}$	—	0.4	—	A	
Average Temperature Coefficient of Output Voltage	$T_{CVO}$	1	$I_{OUT} = 5\text{ mA}$	—	-2.5	—	$\text{mV}/^\circ\text{C}$	

TA7820SB

**ELECTRICAL CHARACTERISTICS**

(Unless otherwise specified,  $V_{IN} = 29\text{ V}$ ,  $I_{OUT} = 500\text{ mA}$ ,  $0^\circ\text{C} \leq T_j \leq 125^\circ\text{C}$ )

CHARACTERISTIC	SYMBOL	TEST CIR-CUIT	TEST CONDITION	MIN.	TYP.	MAX.	UNIT	
Output Voltage	$V_{OUT}$	1	$T_j = 25^\circ\text{C}$ , $I_{OUT} = 100\text{ mA}$	19.2	20.0	20.8	V	
Line Regulation	Reg·line	1	$T_j = 25^\circ\text{C}$	$23\text{ V} \leq V_{IN} \leq 35\text{ V}$	—	15	400	mV
				$26\text{ V} \leq V_{IN} \leq 32\text{ V}$	—	5	200	
Load Regulation	Reg·load	1	$T_j = 25^\circ\text{C}$	$5\text{ mA} \leq I_{OUT} \leq 1.4\text{ A}$	—	12	400	mV
				$250\text{ mA} \leq I_{OUT} \leq 750\text{ mA}$	—	4	200	
Output Voltage	$V_{OUT}$	1	$T_j = 25^\circ\text{C}$ $23\text{ V} \leq V_{IN} \leq 35\text{ V}$ $5.0\text{ mA} \leq I_{OUT} \leq 1.0\text{ A}$	19.0	—	21.0	V	
Quiescent Current	$I_B$	1	$T_j = 25^\circ\text{C}$ , $I_{OUT} = 5\text{ mA}$	—	4.6	8.0	mA	
Quiescent Current Change	$\Delta I_B$	1	$23\text{ V} \leq V_{IN} \leq 35\text{ V}$ , $I_{OUT} = 5\text{ mA}$ , $T_j = 25^\circ\text{C}$	—	—	1.0	mA	
Output Noise Voltage	$V_{NO}$	2	$T_a = 25^\circ\text{C}$ , $10\text{ Hz} \leq f \leq 100\text{ kHz}$ $I_{OUT} = 50\text{ mA}$	—	135	—	$\mu\text{V}_{rms}$	
Ripple Rejection	R.R.	3	$f = 120\text{ Hz}$ , $24\text{ V} \leq V_{IN} \leq 34\text{ V}$ $I_{OUT} = 50\text{ mA}$ , $T_j = 25^\circ\text{C}$	50	66	—	dB	
Dropout Voltage	$V_D$	1	$I_{OUT} = 1.0\text{ A}$ , $T_j = 25^\circ\text{C}$	—	2.0	—	V	
Short Circuit Current Limit	$I_{SC}$	1	$T_j = 25^\circ\text{C}$	—	0.4	—	A	
Average Temperature Coefficient of Output Voltage	$T_{CVO}$	1	$I_{OUT} = 5\text{ mA}$	—	-3.0	—	$\text{mV}/^\circ\text{C}$	

TA7824SB

### ELECTRICAL CHARACTERISTICS

(Unless otherwise specified,  $V_{IN} = 33\text{ V}$ ,  $I_{OUT} = 500\text{ mA}$ ,  $0^\circ\text{C} \leq T_j \leq 125^\circ\text{C}$ )

CHARACTERISTIC	SYMBOL	TEST CIRCUIT	TEST CONDITION	MIN.	TYP.	MAX.	UNIT	
Output Voltage	$V_{OUT}$	1	$T_j = 25^\circ\text{C}$ , $I_{OUT} = 100\text{ mA}$	23.0	24.0	25.0	V	
Line Regulation	Reg·line	1	$T_j = 25^\circ\text{C}$	$27\text{ V} \leq V_{IN} \leq 38\text{ V}$	—	18	480	mV
				$30\text{ V} \leq V_{IN} \leq 36\text{ V}$	—	6	240	
Load Regulation	Reg·load	1	$T_j = 25^\circ\text{C}$	$5\text{ mA} \leq I_{OUT} \leq 1.4\text{ A}$	—	12	480	mV
				$250\text{ mA} \leq I_{OUT} \leq 750\text{ mA}$	—	4	240	
Output Voltage	$V_{OUT}$	1	$T_j = 25^\circ\text{C}$ $27\text{ V} \leq V_{IN} \leq 38\text{ V}$ $5.0\text{ mA} \leq I_{OUT} \leq 1.0\text{ A}$	22.8	—	25.2	V	
Quiescent Current	$I_B$	1	$T_j = 25^\circ\text{C}$ , $I_{OUT} = 5\text{ mA}$	—	4.6	8.0	mA	
Quiescent Current Change	$\Delta I_B$	1	$27\text{ V} \leq V_{IN} \leq 38\text{ V}$ , $I_{OUT} = 5\text{ mA}$ , $T_j = 25^\circ\text{C}$	—	—	1.0	mA	
Output Noise Voltage	$V_{NO}$	2	$T_a = 25^\circ\text{C}$ , $10\text{ Hz} \leq f \leq 100\text{ kHz}$ $I_{OUT} = 50\text{ mA}$	—	150	—	$\mu\text{V}_{rms}$	
Ripple Rejection	R.R.	3	$f = 120\text{ Hz}$ , $28\text{ V} \leq V_{IN} \leq 38\text{ V}$ $I_{OUT} = 50\text{ mA}$ , $T_j = 25^\circ\text{C}$	50	66	—	dB	
Dropout Voltage	$V_D$	1	$I_{OUT} = 1.0\text{ A}$ , $T_j = 25^\circ\text{C}$	—	2.0	—	V	
Short Circuit Current Limit	$I_{SC}$	1	$T_j = 25^\circ\text{C}$	—	0.3	—	A	
Average Temperature Coefficient of Output Voltage	$T_{CVO}$	1	$I_{OUT} = 5\text{ mA}$	—	-3.5	—	$\text{mV}/^\circ\text{C}$	

### TEST CIRCUIT 1 / STANDARD APPLICATION CIRCUIT

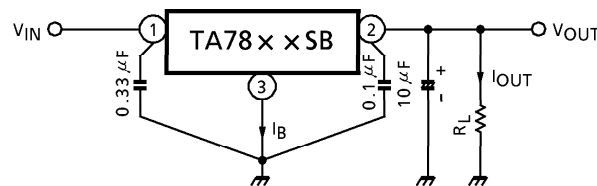

### TEST CIRCUIT 2 $V_{NO}$

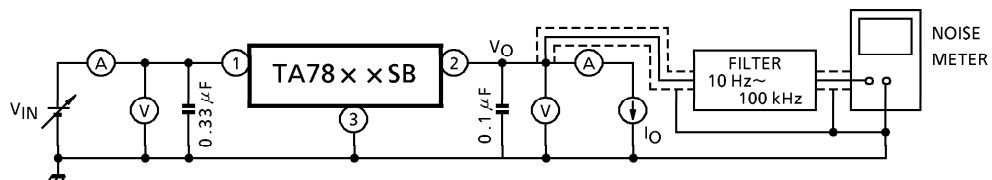

### TEST CIRCUIT 3 R.R.

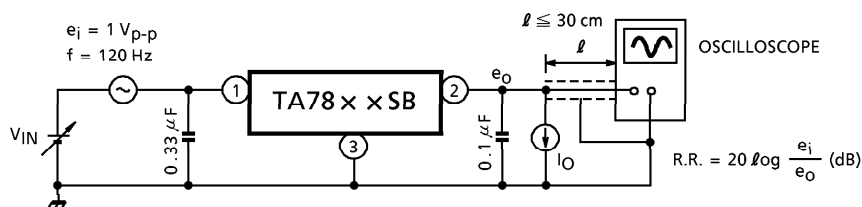

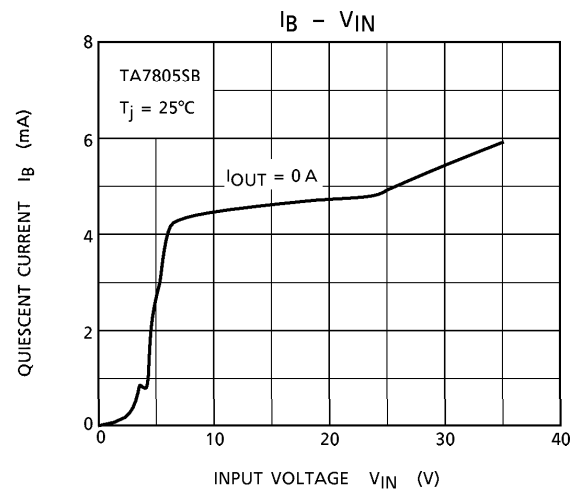
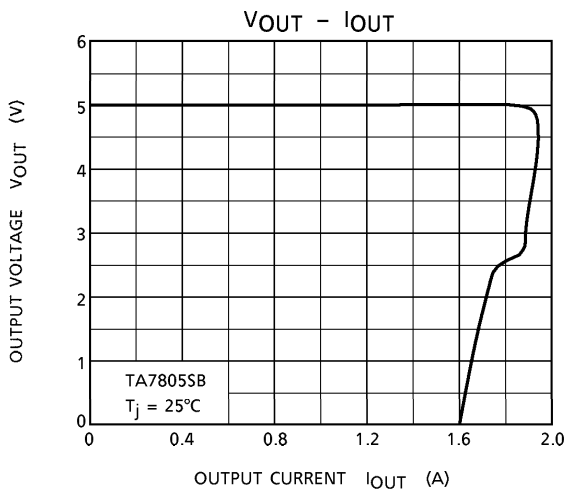
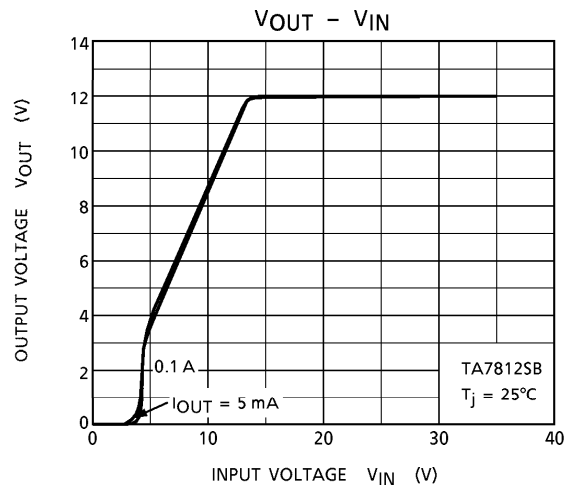
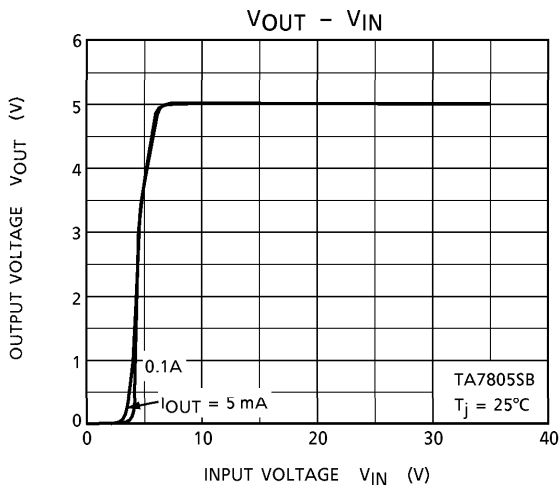
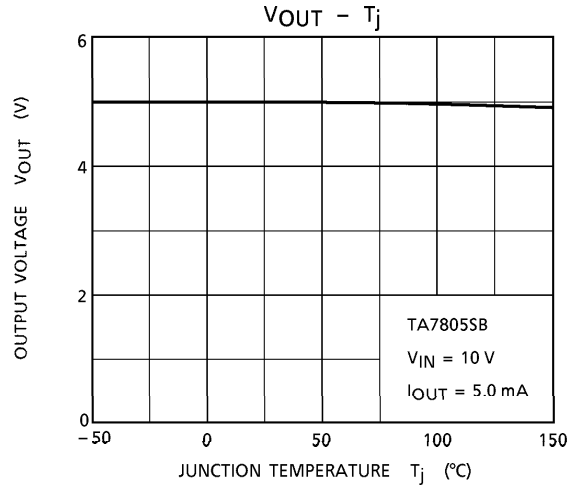
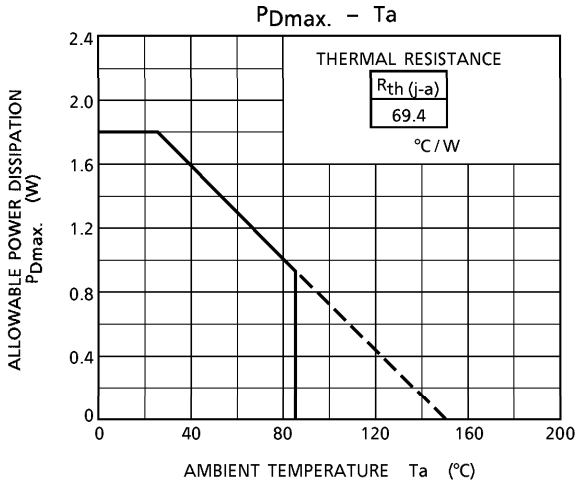

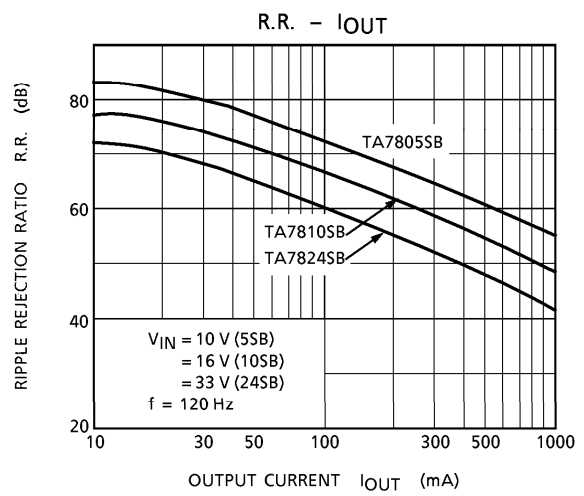
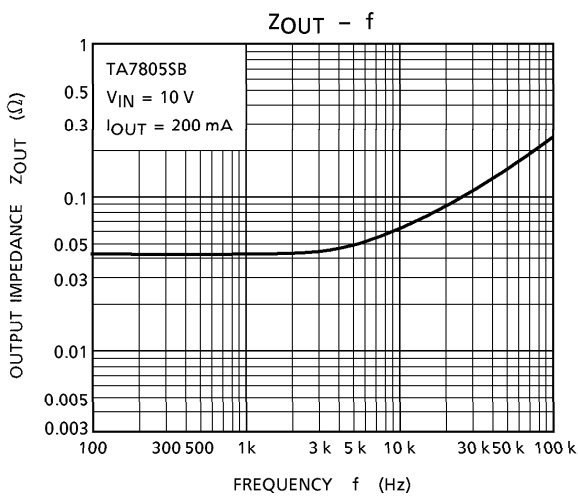
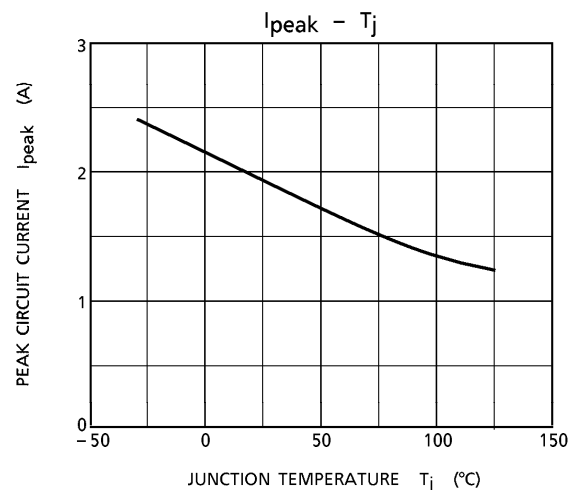
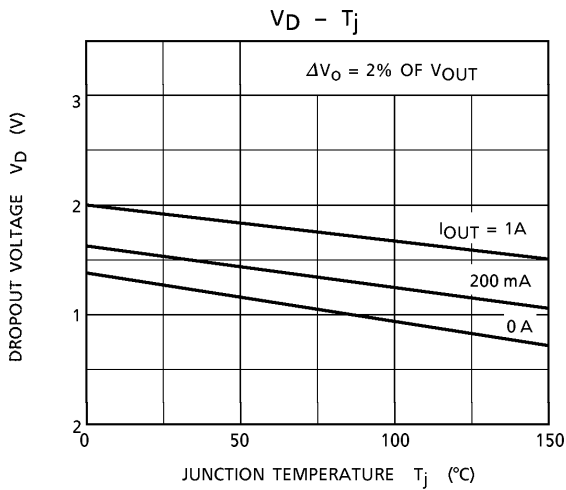
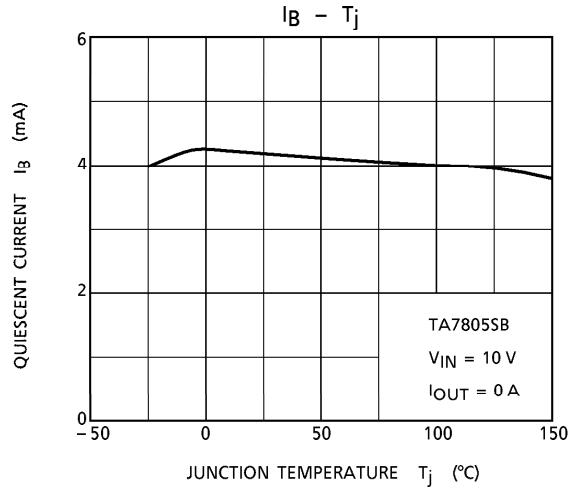
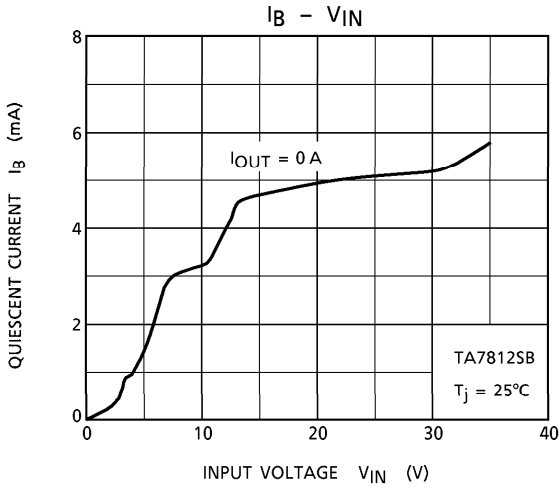



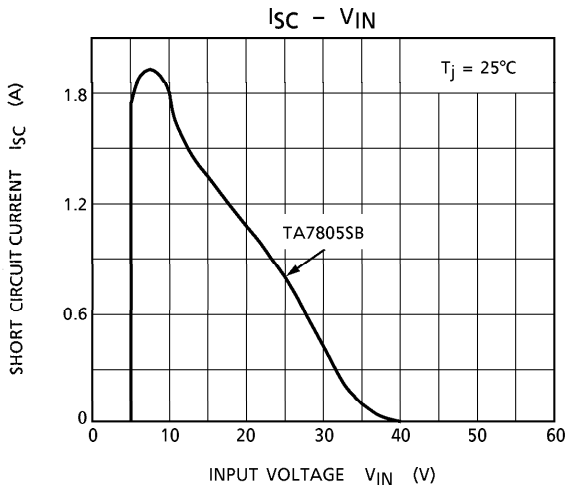

**PRECAUTIONS ON APPLICATION**

- (1) In regard to GND, be careful not to apply a negative voltage to the input/output terminal. Further, special care is necessary in case of a voltage boost application.
- (2) When a surge voltage exceeding maximum rating is applied to the input terminal or when a voltage in excess of the input terminal voltage is applied to the output terminal, the circuit may be destroyed.

Specially, in the latter case, great care is necessary.

Further, if the input terminal shorts to GND in a state of normal operation, the output terminal voltage becomes higher than the input voltage (GND potential), and the electric charge of a chemical capacitor connected to the output terminal flows into the input side, which may cause the destruction of circuit.

In these cases, take such steps as a zener diode and a general silicon diode are connected to the circuit, as shown in the following figure.

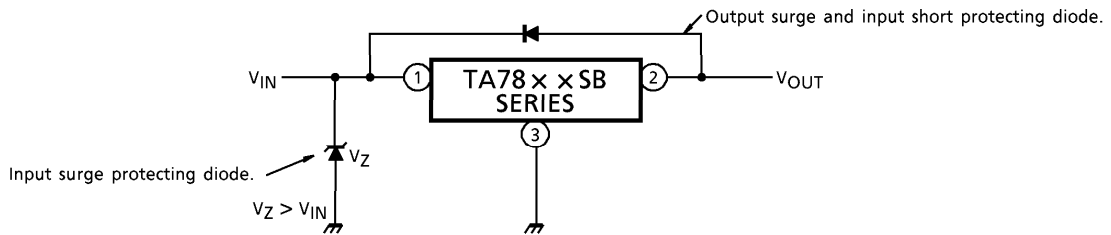

- (3) When the input voltage is too high, the power dissipation of three terminal regulator increases because of series regulator, so that the junction temperature rises. In such a case, it is recommended to reduce the power dissipation by inserting the power limiting resistor  $R_{SD}$  in the input terminal, and to reduce the junction temperature as a result.

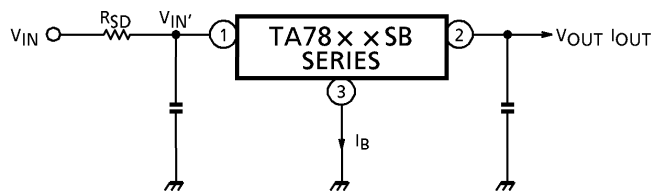

The power dissipation  $P_D$  of IC is expressed in the following equation.

$$P_D = (V_{IN}' - V_{OUT}) \cdot I_{OUT} + V_{IN}' \cdot I_B$$

If  $V_{IN}'$  is reduced below the lowest voltage necessary for the IC, the parasitic oscillation will be caused according to circumstances.

In determining the resistance value of  $R_{SD}$ , design with margin should be made by making reference to the following equation.

$$R_{SD} < \frac{V_{IN} - V_{IN}'}{I_{OUT} + I_B}$$

- (4) Connect the input terminal and GND, and the output terminal and GND, by capacitor respectively. The capacitances should be determined experimentally because they depend on printed patterns. In particular, adequate investigation should be made so that there is no problem even at time of high or low temperature.

**APPLICATION CIRCUITS**

(1) Voltage boost regulator

(a) Voltage boost by use of zener diode

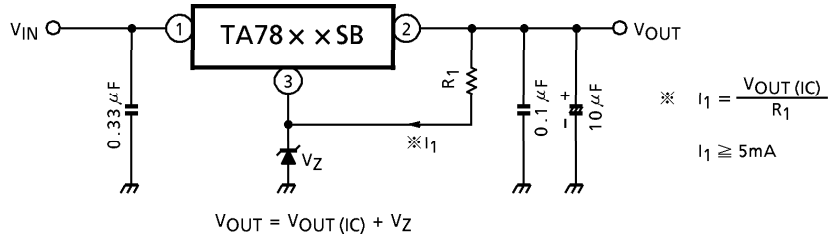

(b) Voltage boost by use of resistor

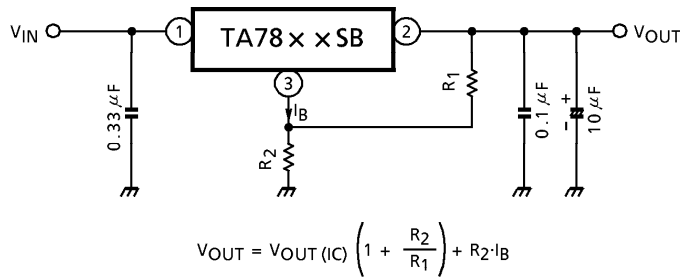

(c) Adjustable output regulator

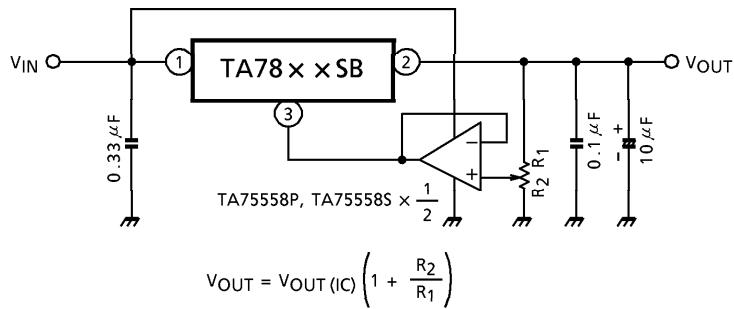

(2) Current boost regulator

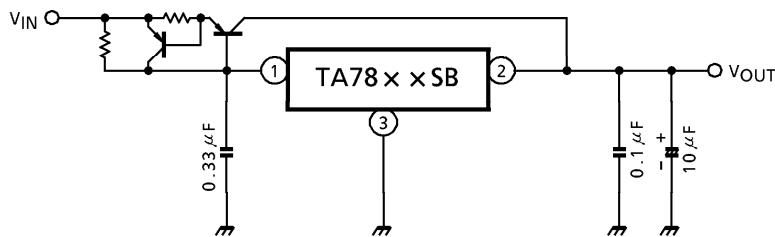

**PACKAGE DIMENSIONS**  
P-SIP3-2.50A

Unit : mm

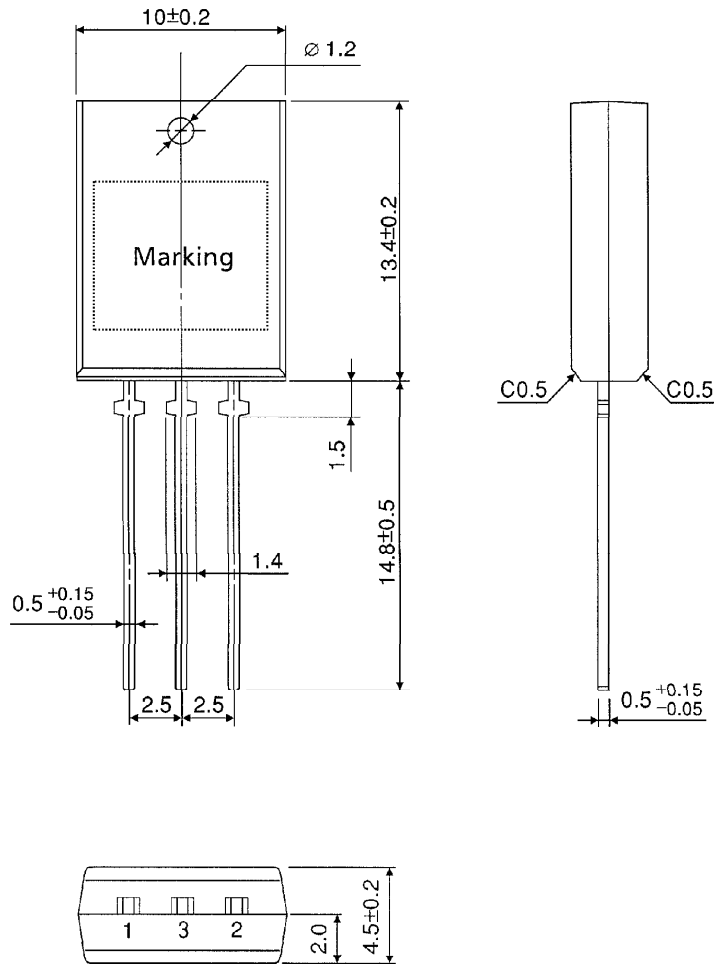

Weight : 1.5 g (Typ.)