

TOSHIBA CMOS DIGITAL INTEGRATED CIRCUIT SILICON MONOLITHIC

TC4S66F, TC4S66FU

BILATERAL SWITCH

TC4S66F/FU contains one circuit of bidirectional switches. When control input, CONT is set to "H" level, the impedance between input and output of the switch becomes low and when it is set to "L" level, the switch becomes high. This can be applied for switching of analog signals and digital signals.

FEATURES

- ON-resistance (R_{ON})
 - 300 Ω (Typ.) $V_{DD} - V_{SS} = 5V$
 - 110 Ω (Typ.) $V_{DD} - V_{SS} = 10V$
 - 70 Ω (Typ.) $V_{DD} - V_{SS} = 15V$
- OFF-resistance (R_{OFF})
 - R_{OFF} (Typ.) $> 10^9 \Omega$

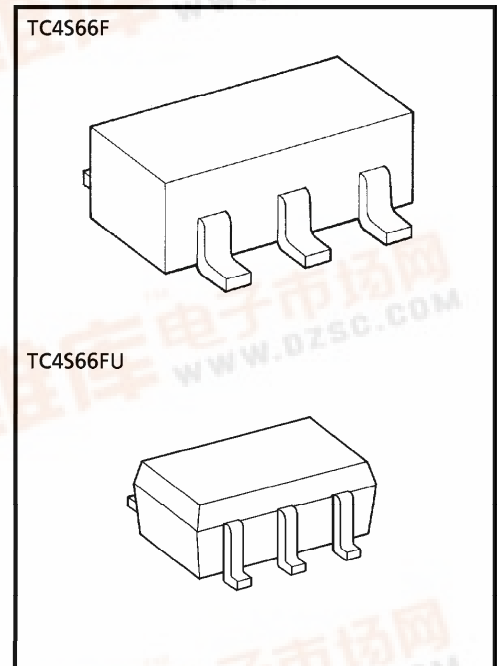

Weight
 SSOP5-P-0.95 : 0.016 g (Typ.)
 SSOP5-P-0.65A : 0.006 g (Typ.)

MAXIMUM RATINGS

CHARACTERISTIC	SYMBOL	RATING	UNIT
DC Supply Voltage	V_{DD}	$V_{SS} - 0.5 \sim V_{SS} + 20$	V
Control Input Voltage	$V_{C IN}$	$V_{SS} - 0.5 \sim V_{DD} + 0.5$	V
Switch I/O Voltage	$V_{I/O}$	$V_{SS} - 0.5 \sim V_{DD} + 0.5$	V
Power Dissipation	P_D	200	mW
Potential difference across I/O during ON	$V_I - V_O$	± 0.5	V
Control Input Current	$I_{C IN}$	± 10	mA
Operating Temperature Range	T_{opr}	$-40 \sim 85$	$^{\circ}C$
Storage Temperature	T_{stg}	$-65 \sim 150$	$^{\circ}C$
Lead Temperature (10 s)	T_L	260	$^{\circ}C$

TRUTH TABLE

CONTROL	IMPEDANCE BETWEEN IN / OUT-OUT / IN *
H	$0.5 \sim 5 \times 10^2 \Omega$
L	$> 10^9 \Omega$

* : See static electrical characteristics.

980910EBA2

● TOSHIBA is continually working to improve the quality and the reliability of its products. Nevertheless, semiconductor devices in general can malfunction or fail due to their inherent electrical sensitivity and vulnerability to physical stress. It is the responsibility of the buyer, when utilizing TOSHIBA products, to observe standards of safety, and to avoid situations in which a malfunction or failure of a TOSHIBA product could cause loss of human life, bodily injury or damage to property. In developing your designs, please ensure that TOSHIBA products are used within specified operating ranges as set forth in the most recent products specifications. Also, please keep in mind the precautions and conditions set forth in the TOSHIBA Semiconductor Reliability Handbook.

● The products described in this document are subject to the foreign exchange and foreign trade laws.

● The information contained herein is presented only as a guide for the applications of our products. No responsibility is assumed by TOSHIBA CORPORATION for any infringements of intellectual property or other rights of the third parties which may result from its use. No license is granted by implication or otherwise under any intellectual property or other rights of TOSHIBA CORPORATION or others.

● The information contained herein is subject to change without notice.

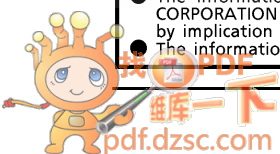

CIRCUIT DIAGRAM

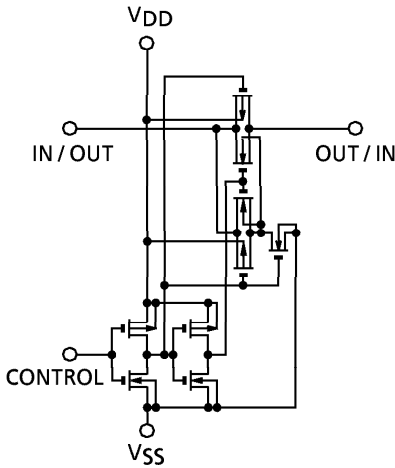

PIN ASSIGNMENT (TOP VIEW)

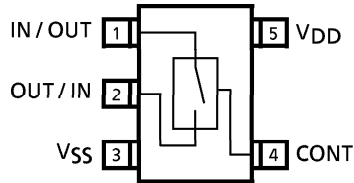

MARKING

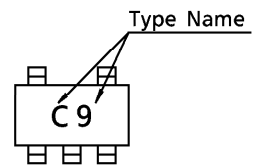

RECOMMENDED OPERATING CONDITIONS (V_{SS} = 0 V)

CHARACTERISTIC	SYMBOL	MIN.	TYP.	MAX.	UNIT
DC Supply Voltage	V _{DD}	3	—	18	V
Input/Output Voltage	V _{IN} /V _{OUT}	0	—	V _{DD}	V

STATIC ELECTRICAL CHARACTERISTICS (In case not specifically appointed, V_{SS} = 0 V)

CHARACTERISTIC	SYM-BOL	TEST CONDITION	V _{DD} (V)	-40°C		25°C			85°C		UNIT	
				MIN.	MAX.	MIN.	TYP.	MAX.	MIN.	MAX.		
Control Input High Voltage	V _{IH}	I _S = 10 μA	5	3.5	—	3.5	2.75	—	3.5	—	V	
			10	7.0	—	7.0	5.50	—	7.0	—		
			15	11.0	—	11.0	8.25	—	11.0	—		
Control Input Low Voltage	V _{IL}	I _S = 10 μA	5	—	1.5	—	2.25	1.5	—	1.5	V	
			10	—	3.0	—	4.5	3.0	—	3.0		
			15	—	4.0	—	6.75	4.0	—	4.0		
On-State Resistance	R _{ON}	0 ≤ V _{IS} ≤ V _{DD} R _L = 10 kΩ	5	—	800	—	290	950	—	1200	Ω	
			10	—	210	—	120	250	—	300		
			15	—	140	—	85	160	—	200		
Input/Output Leakage Current	I _{OFF}	V _{IN} = 18 V V _{OUT} = 0 V V _{IN} = 0 V V _{OUT} = 18 V	18	—	±100	—	±0.1	±100	—	±1000	nA	
			18	—	±100	—	±0.1	±100	—	±1000		
Quiescent Device Current	I _{DD}	V _{IN} = V _{DD} , V _{SS}	5	—	0.25	—	0.001	0.25	—	7.5	μA	
			10	—	0.5	—	0.001	0.5	—	15		
			15	—	1.0	—	0.002	1.0	—	30		
Input Current	H Level	I _{IH}	V _{IH} = 18 V	18	—	0.1	—	10 ⁻⁵	0.1	—	1.0	μA
	L Level	I _{OL}	V _{IL} = 0 V	18	—	-0.1	—	-10 ⁻⁵	-0.1	—	-1.0	

DYNAMIC ELECTRICAL CHARACTERISTICS (Ta = 25°C)

CHARACTERISTIC	SYMBOL	TEST CONDITION	TEST CONDITION		MIN.	TYP.	MAX.	UNIT
			V _{SS} (V)	V _{DD} (V)				
Propagation Delay Time (IN-OUT)	t _{pLH} t _{pHL}	C _L = 50 pF	0	5	—	15	40	ns
			0	10	—	8	20	
			0	15	—	5	15	
Propagation Delay Time (CONTROL-OUT)	t _{pZL} t _{pZH}	R _L = 1 kΩ C _L = 50 pF	0	5	—	55	120	
			0	10	—	25	40	
			0	15	—	20	30	
Propagation Delay Time (CONTROL-OUT)	t _{pLZ} t _{pHZ}	R _L = 1 kΩ C _L = 50 pF	0	5	—	45	80	
			0	10	—	30	70	
			0	15	—	25	60	
Max. Control Input Repetition Rate	f _{MAX} (C)	R _L = 1 kΩ C _L = 50 pF	0	5	—	10	—	MHz
			0	10	—	12	—	
			0	15	—	12	—	
– 3dB Cut Off Frequency	f _{MAX} (I-O)	R _L = 1 kΩ C _L = 50 pF (*1)	–5	5	—	30	—	
Total Harmonic Distortion	—	R _L = 10 kΩ f = 1 kHz (*2)	–5	5	—	0.03	—	%
– 50dB Feedthrough Frequency	—	R _L = 1 kΩ (*3)	–5	5	—	600	—	kHz
Crosstalk (CONTROL-OUT)	—	R _{IN} = 1 kΩ R _{OUT} = 10 kΩ C _L = 15 pF	0	5	—	200	—	mV
			0	10	—	400	—	
			0	15	—	600	—	
Input Capacitance	C _{IN}	Control Input	—	—	—	5	7.5	pF
		Switch I/O	—	—	—	10	—	
Feedthrough Capacitance	C _{IN-OUT}	—	—	—	—	0.5	—	

*1 : The frequency at $20\log_{10} \frac{V_{OS}}{V_{IS}} = -3$ dB shall be f_{MAX}(I/O) using sine wave of ±2.5 V_{p-p} for V_{IS}.

*2 : V_{IS} shall be sine wave of ±2.5 V.

*3 : The frequency at $20\log_{10} \frac{V_{OS}}{V_{IS}} = 50$ dB shall be the feed through using of ±2.5 V_{p-p}.

1. t_{pLH} , t_{pHL}

I/O-O/I

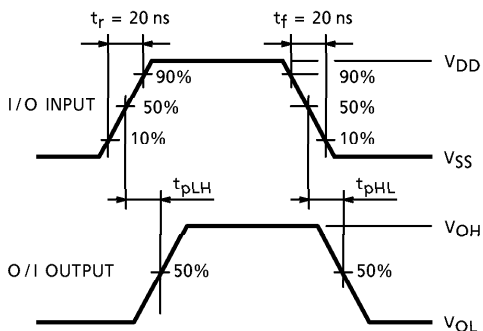
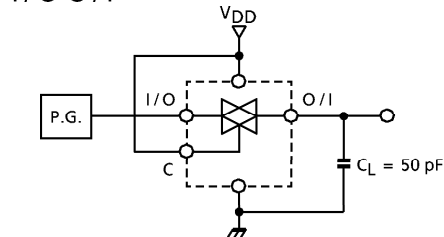

2. t_{pZL} , t_{pZH} , t_{pLZ} , t_{pHZ}

CONTROL-O/I

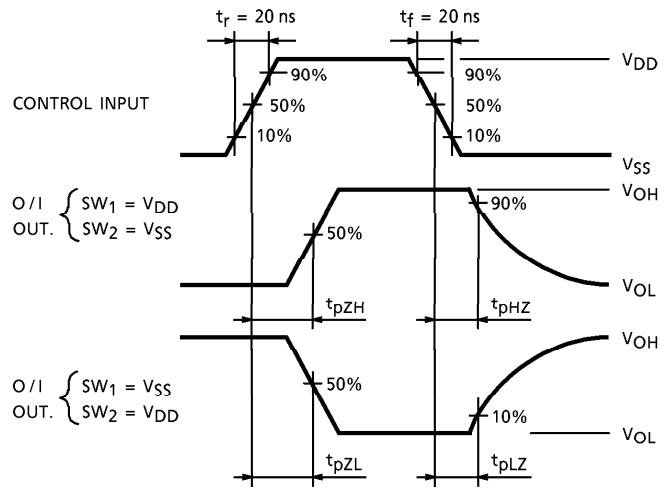
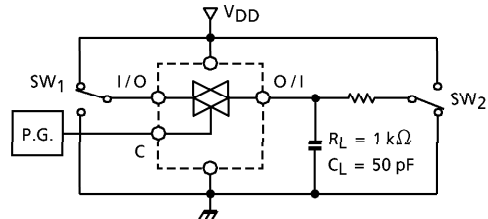

3. R_{ON}

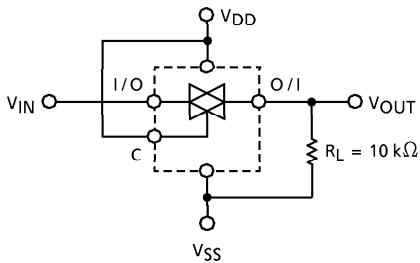

$$R_{ON} = 10 \times \frac{(V_{IN} - V_{OUT})}{V_{OUT}} \text{ (k}\Omega\text{)}$$

4. $f_{MAX}(C)$

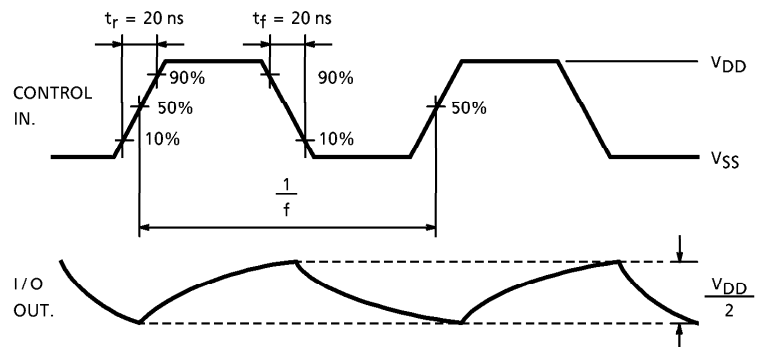
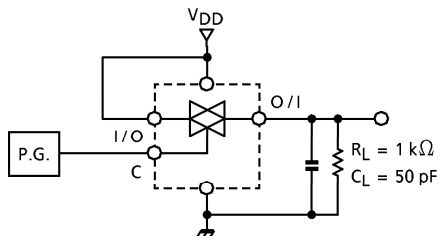

5. CROSSTALK (CONTROL INPUT)

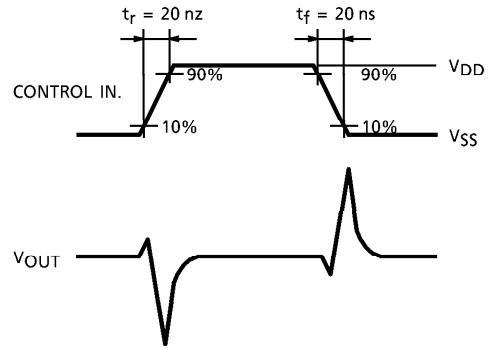
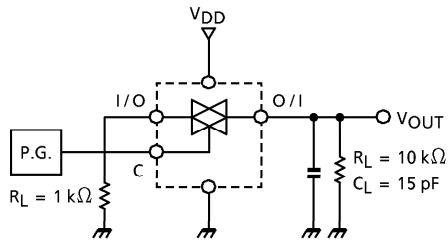

6. TOTAL HARMONIC DISTORTION, f_{MAX} (I/O-O/I), FEEDTHROUGH (SWITCH OFF)

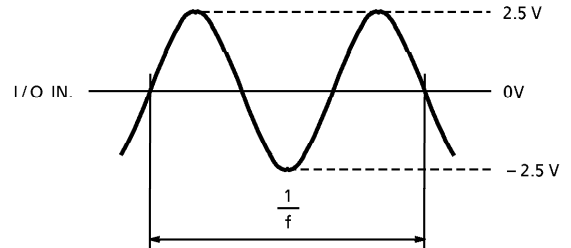
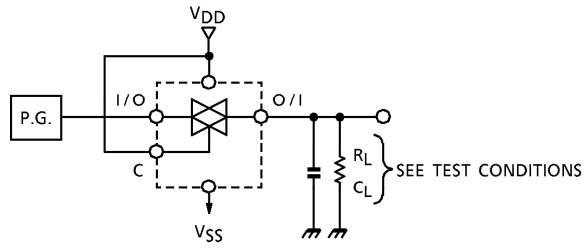

PACKAGE DIMENSIONS
SSOP5-P-0.95

Unit : mm

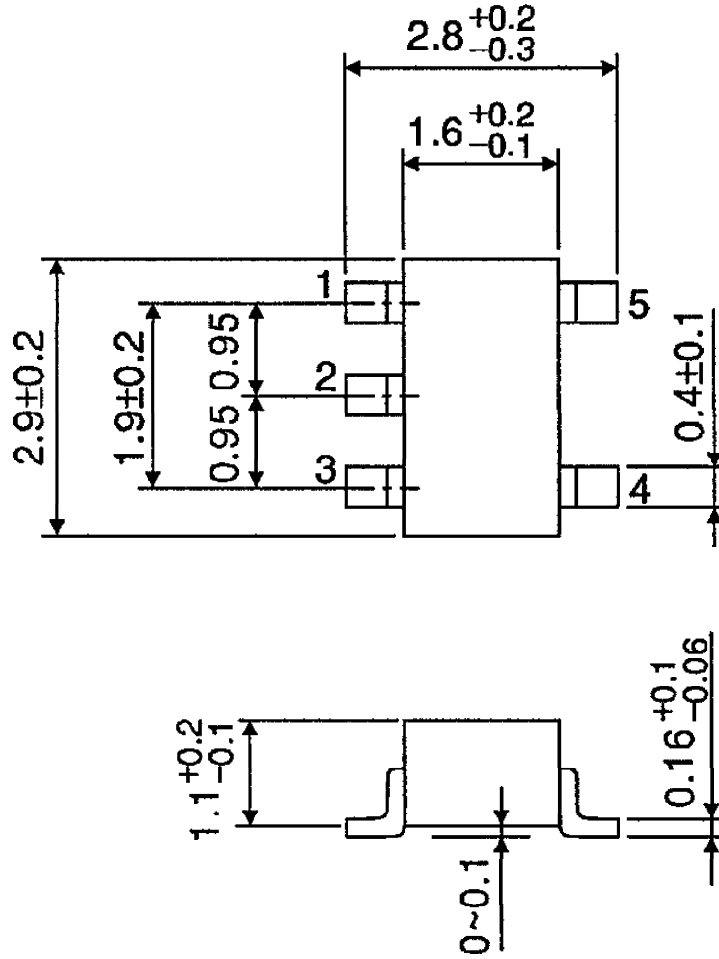

Weight : 0.016 g (Typ.)

PACKAGE DIMENSIONS
SSOP5-P-0.65A

Unit : mm

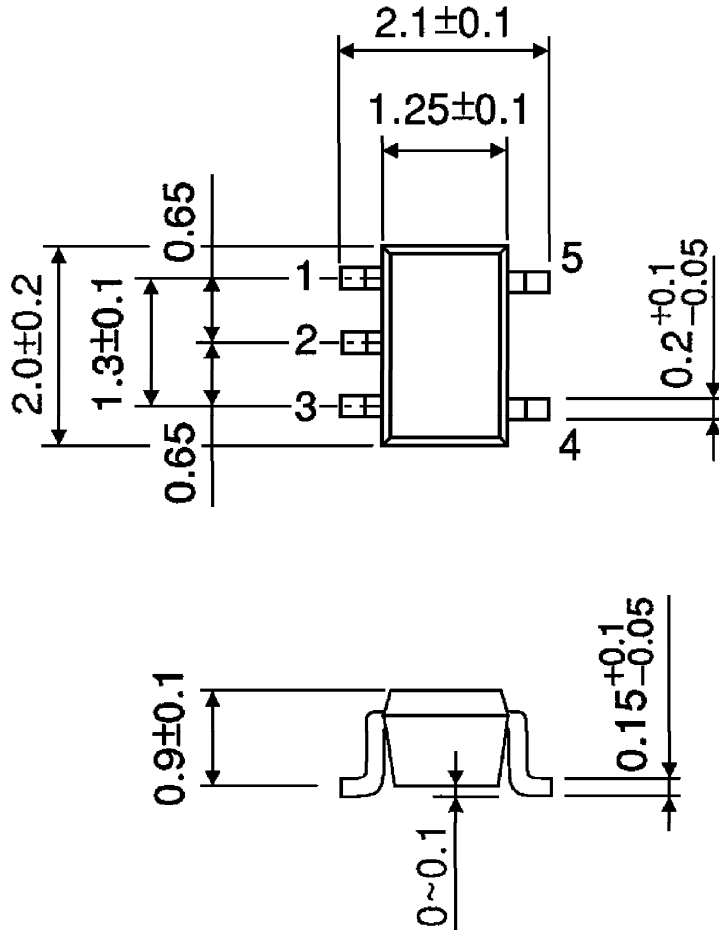

Weight : 0.006 g (Typ.)