

SIEMENS

BSM35GD120DN2E3224

Circuit Diagram

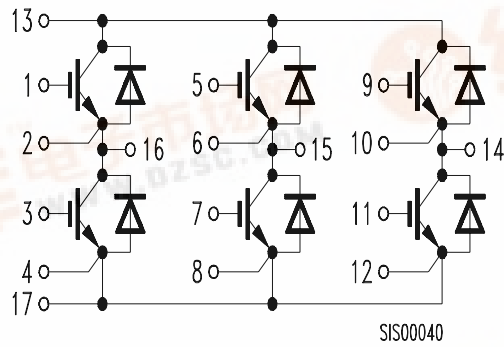

Package Outlines

Dimensions in mm

Weight: 180 g

