



SINGLE-SUPPLY QUAD COMPARATOR

GENERAL DESCRIPTION

These devices offer higher frequency operation and faster switching than can be had from internally compensated quad op amps. Indeed for single-supply applications, the Darlington PNP input stage allows them to compare voltages that include ground. The two-stage common-emitter output circuit provides gain and output sink capacity of 6mA at an output level of 400mV. The output collector is left open, permitting the designer to drive devices in the range of 2V to 36V.

FEATURES

- Operating Voltage (+2V ~ +36V)
- Single Supply Operation
- Open Collector Output
- Package Outline DIP14, DMP14, SSOP14
- Bipolar Technology

PACKAGE OUTLINE

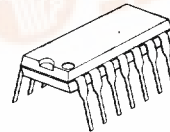

NJM2901N

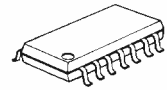

NJM2901M



NJM2901V

PIN CONFIGURATION

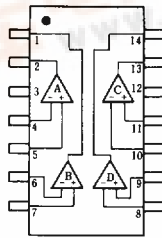

NJM2901N
NJM2901M
NJM2901V

PIN FUNCTION

1. B OUTPUT
2. A OUTPUT
3. V+
4. A- INPUT
5. A+ INPUT
6. B- INPUT
7. B+ INPUT
8. C- INPUT
9. C+ INPUT
10. D- INPUT
11. D+ INPUT
12. GND
13. D OUTPUT
14. C OUTPUT

EQUIVALENT CIRCUIT (1/4 Shown)

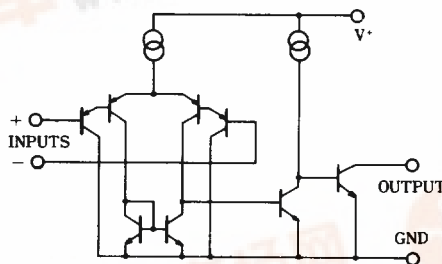



■ ABSOLUTE MAXIMUM RATINGS

(Ta=25°C)

PARAMETER	SYMBOL	RATINGS	UNIT
Supply Voltage	V*	36(±18)	V
Differential Input Voltage	V _{ID}	36	V
Input Voltage	V _{IN}	-0.3~+36	V
Power Dissipation	P _D	(DIP14) 570	mW
		(DMP14) 300	mW
		(SSOP14) 300	mW
Operating Temperature Range	T _{opr}	-40~+85	°C
Storage Temperature Range	T _{stg}	-50~+125	°C

■ ELECTRICAL CHARACTERISTICS

(Ta=25°C, V*=5V)

PARAMETER	SYMBOL	TEST CONDITION	MIN.	TYP.	MAX.	UNIT
Input Offset Voltage	V _{IO}	R _S =0Ω, V _O ≅1.4V	—	2	7	mV
Input Offset Current	I _{IO}	I _{IN} =I _{IN} ⁺ -I _{IN} ⁻	—	5	50	nA
Input Bias Current	I _B		—	25	250	nA
Input Common Mode Voltage Range	V _{ICM}		0~3.5	—	—	V
Large Signal Voltage Gain	A _V	R _L =15kΩ	—	106	—	dB
Response Time	t _R	R _L =5.1kΩ	—	1.3	—	μs
Output Sink Current	I _{SINK}	V _{IN} ⁻ =1V, V _{IN} ⁺ =0V, V _O =1.5V	6	16	—	mA
Output Saturation Voltage	V _{SAT}	V _{IN} ⁻ =1V, V _{IN} ⁺ =0V, I _{SINK} =3mA	—	200	400	mV
Output Leakage Current	I _{LEAK}	V _{IN} ⁻ =0V, V _{IN} ⁺ =1V, V _O =5V	—	0.1	1.0	μA
Operating Current	I _{CC}	R _L =∞	—	0.8	2	mA



TYPICAL CHARACTERISTICS

Input Offset Voltage vs. Temperature
($V^+ = 5\text{ V}$)

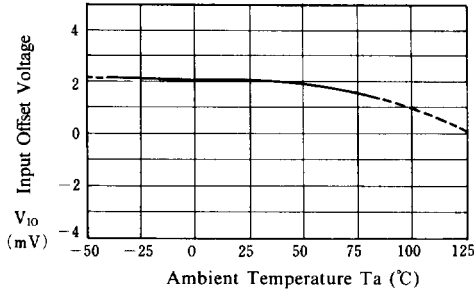

Operating Current
($R_L = \infty$)

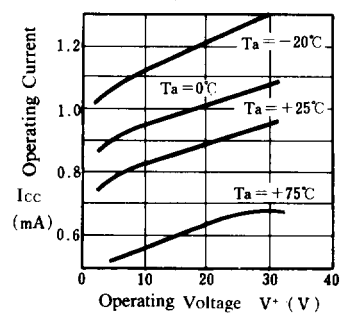

Input Bias Current

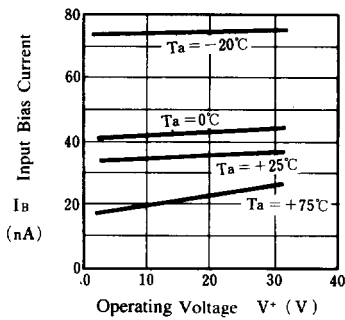

Output Saturation Voltage
($V^+ = 5\text{ V}$)

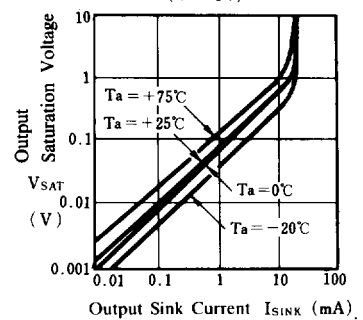

Response Time for Various Input Over Drives
($V^+ = 5\text{ V}$, $R_L = 5.1\text{ k}\Omega$, $T_a = 25^\circ\text{C}$)

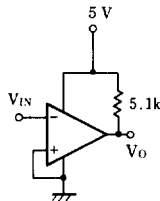
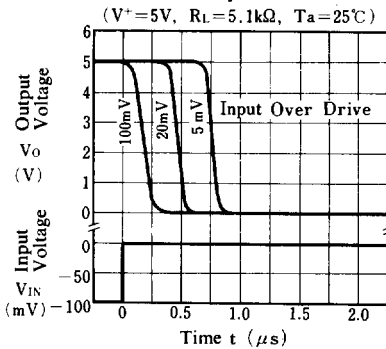

Response Time for Various Input Over Drives
($V^+ = 5\text{ V}$, $R_L = 5.1\text{ k}\Omega$, $T_a = 25^\circ\text{C}$)

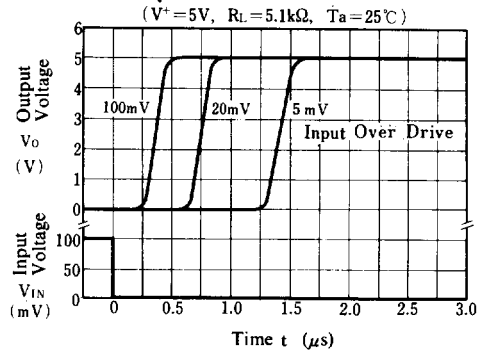



■ TYPICAL APPLICATIONS

Basic Comparator

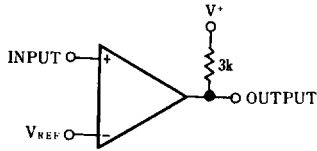

Comparator With Hysteresis

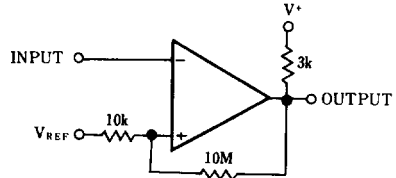

Zero Crossing Detector

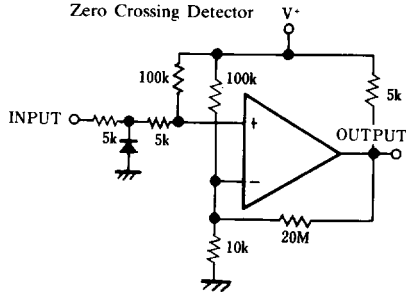

Low Frequency Op Amp.

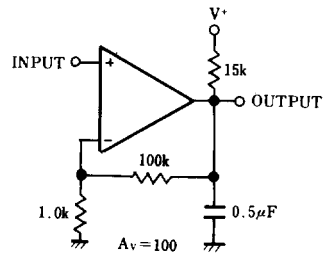

Pulse Generator

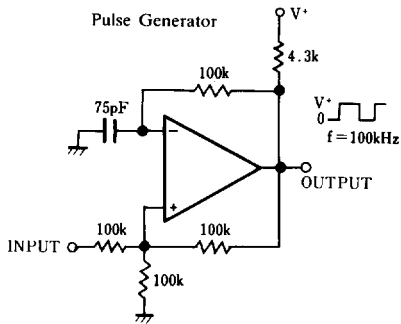

Limit Comparator

