

SIEMENS

Nonvolatile Memory 8-Kbit E²PROM with I²C Bus and Write Protection

SDA 3586-5
MOS IC

Features

- Word-organized programmable nonvolatile memory in n-channel floating-gate technology (E²PROM)
- 1024 × 8-bit organization
- Supply voltage 5 V
- Serial 2-line bus for data input and output (I²C Bus)
- Reprogramming mode, 10 ms erase / write cycle
- Reprogramming by means of on-chip control (without external control)
- Check for end of programming process
- Data retention > 10 years
- More than 10⁵ reprogramming cycles **per address**
- Write protection mode

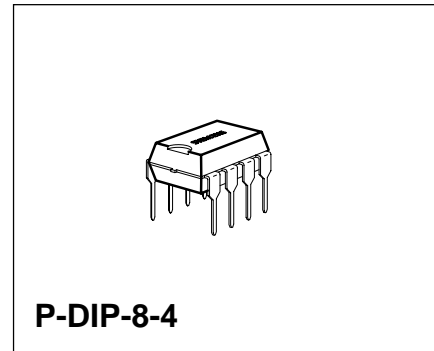

Type	Ordering Code	Package	Pin Configuration
SDA 3586-5	Q67100-H5102	P-DIP-8-4	SIEMENS

Circuit Description

I²C Bus Interface

The I²C Bus is a bidirectional 2-line bus for the transfer of data between various integrated circuits. It consists of a serial data line SDA and a serial clock line SCL. The data line requires an external pull-up resistor to V_{CC} (open drain output stage).

The possible operational states of the I²C Bus are shown in **figure 1**. In the quiescent state, both lines SDA and SCL are high, i.e. the output stage of the data line is disabled. As long as SCL remains "1", information changes on the data bus indicate the start or the end of data transfer between two components.

The transition on SDA from "1" to "0" is a start condition, the transition from "0" to "1" is a stop condition. During a data transfer the information on the data bus will only change while the clock line SCL is "0". The information on SDA is valid as long as SCL is "1".

In conjunction with an I²C Bus system, the memory component can operate as a receiver and as a transmitter (slave receiver or slave transmitter). Between a start and stop condition, information is always transmitted in byte-organized form. Between the falling edge of the eighth clock pulse and a ninth acknowledge clock pulse, the memory component sets the SDA-line to low as a confirmation of reception, if the chip select conditions have been met. During the output of data, the data output of the memory is high in impedance during the ninth clock pulse (acknowledge master).

The necessary temporary signal function for the operation of the I²C Bus is shown in **figure 2**.

Control Functions of the I²C Bus

The memory component is controlled by the controller (master) via the I²C Bus in two operating modes: read-out cycle, and reprogramming cycle, including erase and write to a memory address. In both operating modes, the controller, as transmitter, has to provide 3 bytes and an additional acknowledge clock pulse to the bus after the start condition. During a memory read, at least nine additional clock pulses are required to accept the data from the memory and the acknowledge master, before the stop condition may follow. In the case of programming, the active programming process is only started by the stop condition after data input (**see figure 3**).

The chip select word contains the chip select bit CS, thus allows 2 memory chips to be connected in parallel. Chip select is achieved when the three control bits logically correspond to the selected conditions at the select inputs.

By means of the bit "Chip Select" CS/E the two bits A8 and A9 (MSB of the chip address) are programmed.

Check for End of Programming or Abortion of Programming Process

If the chip is addressed during active reprogramming by entering CS/E, the programming process is terminated. If, however, it is addressed by entering CS/A, the entry will be ignored. Only after programming has been terminated will the chip respond to CS/A. This allows the user to check whether the end of the programming process has been reached (**see figure 3**).

Memory Read

After the input of the first two control words CS/E and WA, a resetting of the start condition and the input of the third control word CS/A, the memory is set ready to read. During acknowledge clock nine, the memory information is transferred in parallel mode to the shift register. Subsequent to the falling edge of the acknowledge clock, the data output is low impedance and the first data bit can be sampled (**see figure 4**).

With every shift clock, an additional bit reaches the output. After reading a byte, the internal address counter is automatically incremented when the master receiver switches the data line to "low" during the ninth clock (acknowledge master). Any number of memory locations can thus be read one after the other. At address 1024, an overflow to address 0 is initiated. With the stop condition, the data output returns to high-impedance mode. The internal sequence control of the memory component is reset from the read to the quiescent state with the stop condition.

Memory Reprogramming

The reprogramming cycle of a memory word comprises an erase and a subsequent write process. During erase, all eight bits of the selected word are set into the "1" state. During write, "0" states are generated according to the information in the internal data register, i.e. according to the third input control word. After the 27th and last clock of the control word input, the active programming process is started by the stop condition. The active reprogramming process is executed under on-chip control.

The time required for reprogramming depends on component deviation and data patterns. Therefore, with rated supply voltage, the erase/write process extends over max. 20 ms, or more typically, 10 ms. In the case of data word input without write request (write request is defined as data bit in data register set to "0"), the write process is suppressed and the programming time is shortened. During a subsequent programming of an already erased memory address, the erase process is suppressed again, so that the reprogramming time is also shortened.

Important: Switch-On Mode and Chip Reset

After the supply voltage V_{CC} has been connected, the data output will be in high-impedance mode. As a rule, **the first operating mode** to be entered, should be the **read process of a word address**. As a result of the built-in "power-on reset" circuit, programming requests will not be accepted immediately after the supply voltage has been switched on.

Total Erase

Enter the control word CS/E, load the address register with address 0 and the data register with FF (hex) to erase the entire contents of the memory. Switch input CS2 to "open" immediately prior to generating the stop condition. The subsequent stop condition triggers a total erase. Upon termination of "total erase", CS2 must be reconnected to 0 V.

Write Protection Mode

When pin 2 is not connected, i. e. when CS0 is floating, this means that:

- 1) memory reprogramming is disabled.
- 2) the chip can only be addressed with chip select bit CS0 = 0 of control word CS/E or CS/A.

Pin Configuration (top view)

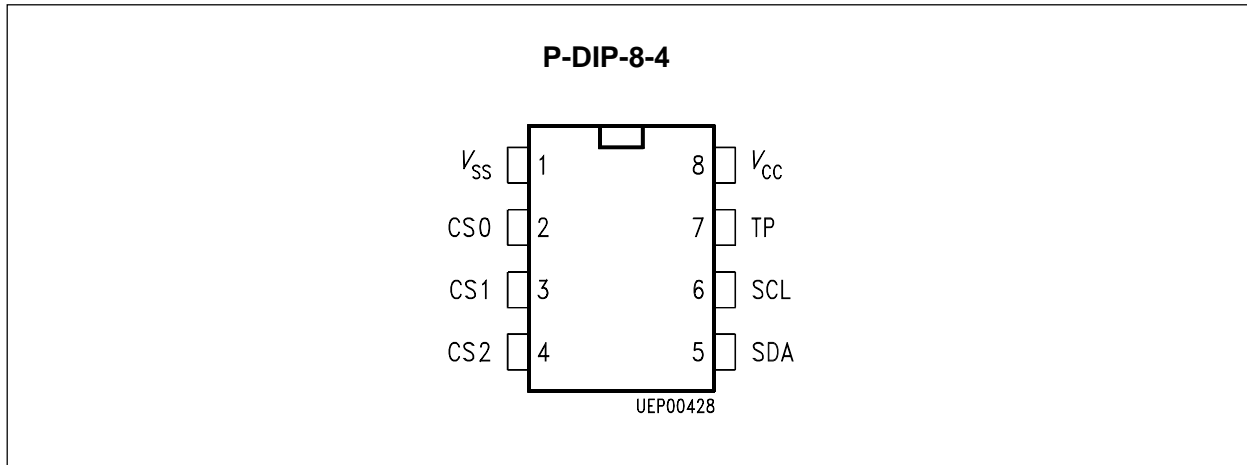

Pin Definitions and Functions

Pin No.	Symbol	Function
1	V_{SS}	Ground
2	CS	Chip select $0 \leq V_I \leq 0.2 \text{ V}$; $4.5 \leq V_I \leq V_{CC}$, open, programming disabled condition
3	TP1	to V_{SS}
4	TP2	0 V norm. operation, TP2 = 5 V total erase condition
5	SDA	Data line
6	SCL	Clock line
7	TP3	Open
8	V_{CC}	Supply voltage

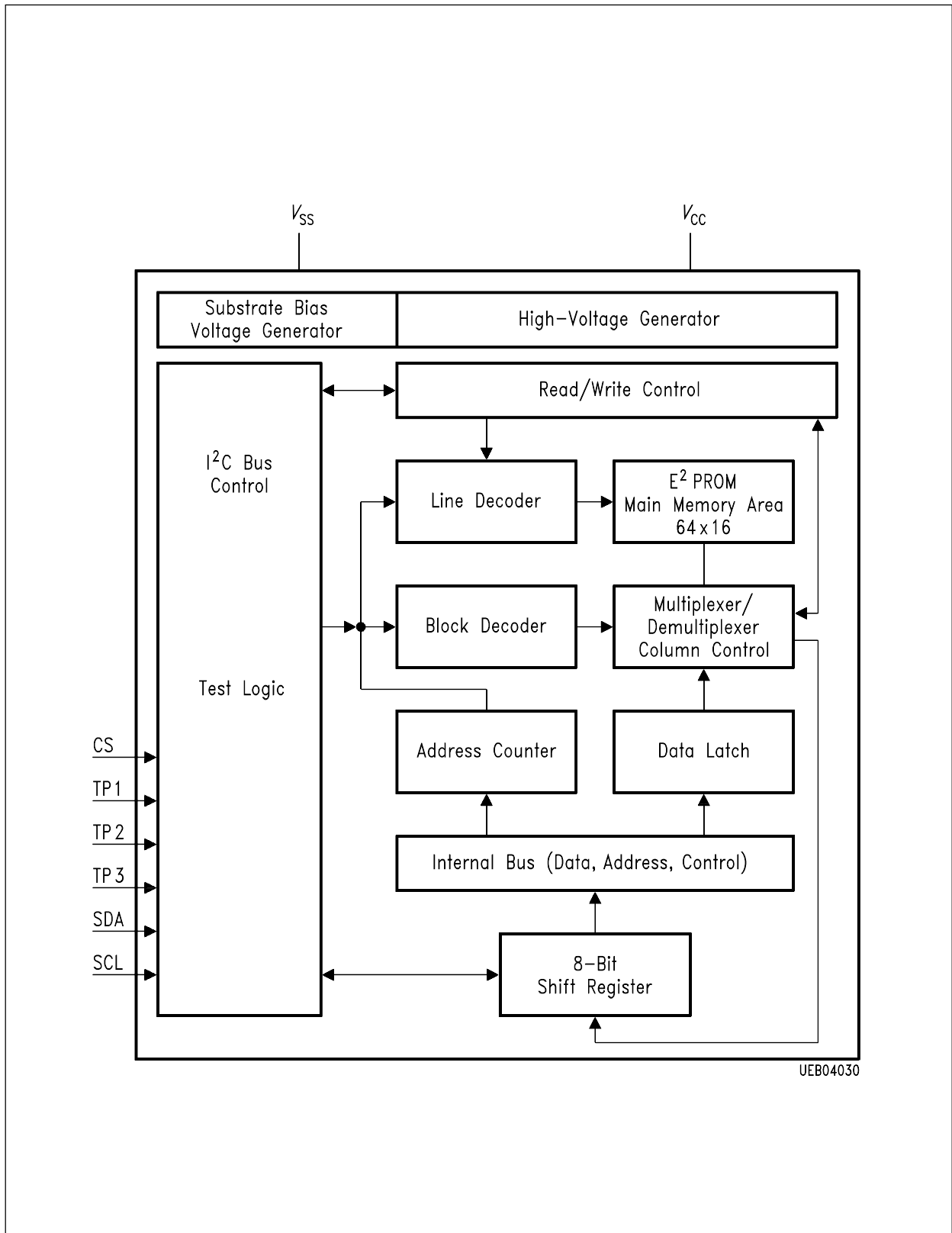

Block Diagram

Absolute Maximum Ratings

Parameter	Symbol	Limit Values		Unit
		min.	max.	
Supply voltage	V_{CC}	- 0.3	6	V
Input voltage	V_I	- 0.3	6	V
Power dissipation	P_D		130	mW
Storage temperature	T_{stg}	- 40	125	°C
Thermal resistance (system air)	$R_{th SA}$		100	K/W
Junction temperature	T_j		85	°C

Operating Range

Supply voltage	V_{CC}	4.75	5.25	V
Ambient temperature	T_A	0	70	°C

Characteristics

$T_A = 25\text{ °C}$

Parameter	Symbol	Limit Values			Unit	Test Condition
		min.	typ.	max.		
Supply voltage	V_{CC}	4.75	5.0	5.25	V	
Supply current	I_{CC}			20	mA	$V_{CC} = 5.25\text{ V}$

Inputs

Input voltages SDA/SCL	V_{IL}			1.5	V	
Input voltages SDA/SCL	V_{IH}	3.0		V_{CC}	V	
Input currents SDA/SCL	I_{IH}			10	μA	$V_{IH} = V_{CC}$

Outputs

Output current SDA	I_{QL}			3.0	mA	$V_{QL} = 0.4\text{ V}$
Leakage current SDA	I_{QH}			10	μA	$V_{QH} = V_{CC\text{ max}}$

Inputs

Input voltages CS/TP1/TP2	V_{IL}			0.2	V	
Input voltages CS/TP1/TP2	V_{IH}	4.5		V_{CC}	V	
Input currents CS/TP1/TP2	I_{IH}			100	μA	$V_{CC} = 5.25\text{ V}$
Clock frequency	f_{SCL}			100	kHz	
Reprogramming duration	t_{PROG}		10	20	ms	erase and write
Input capacity	C_I			10	pF	
Total erase	t_{GL}			20	ms	TP2 = 5 V

Diagrams

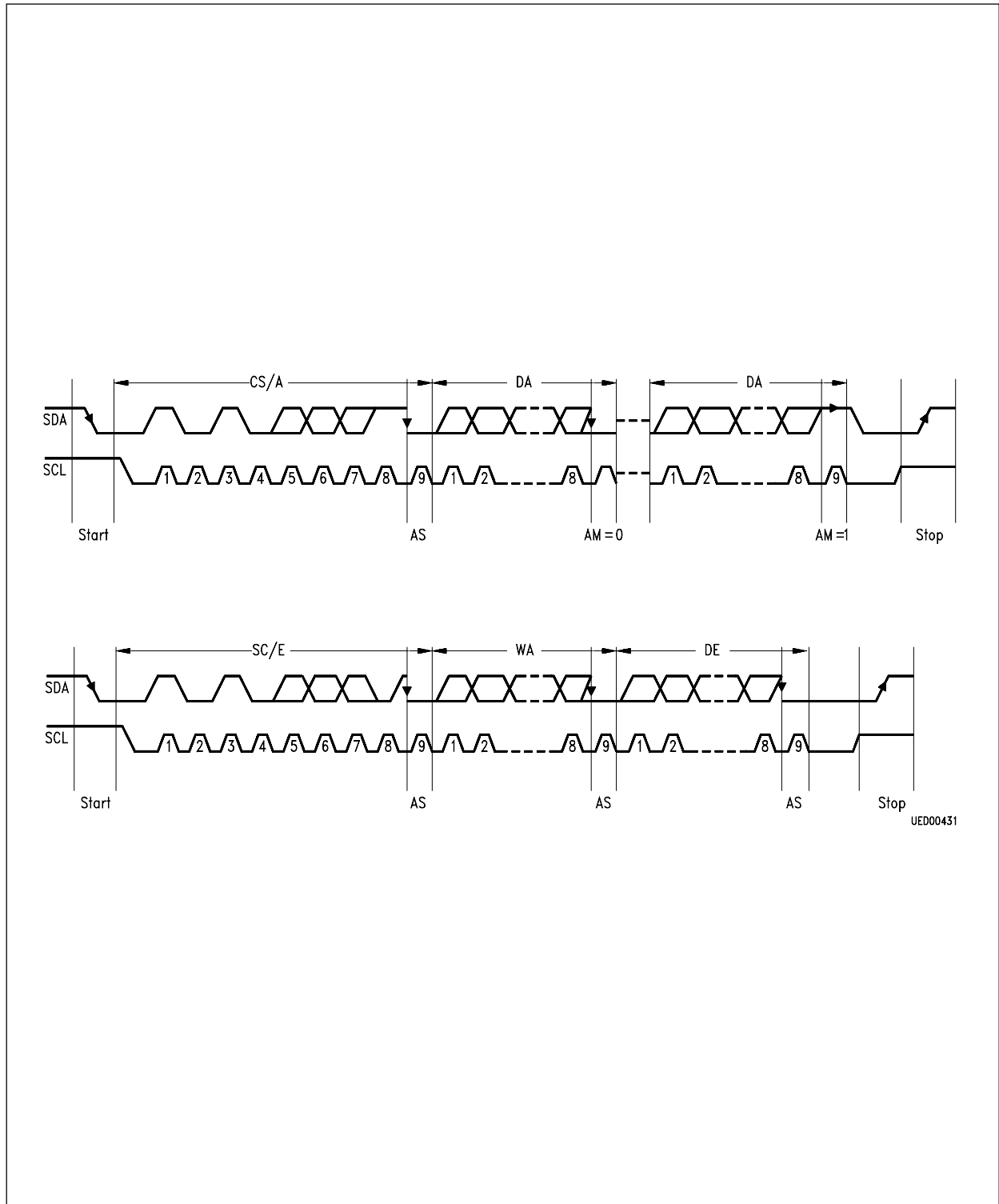

Figure 1
Operation States of the I²C Bus

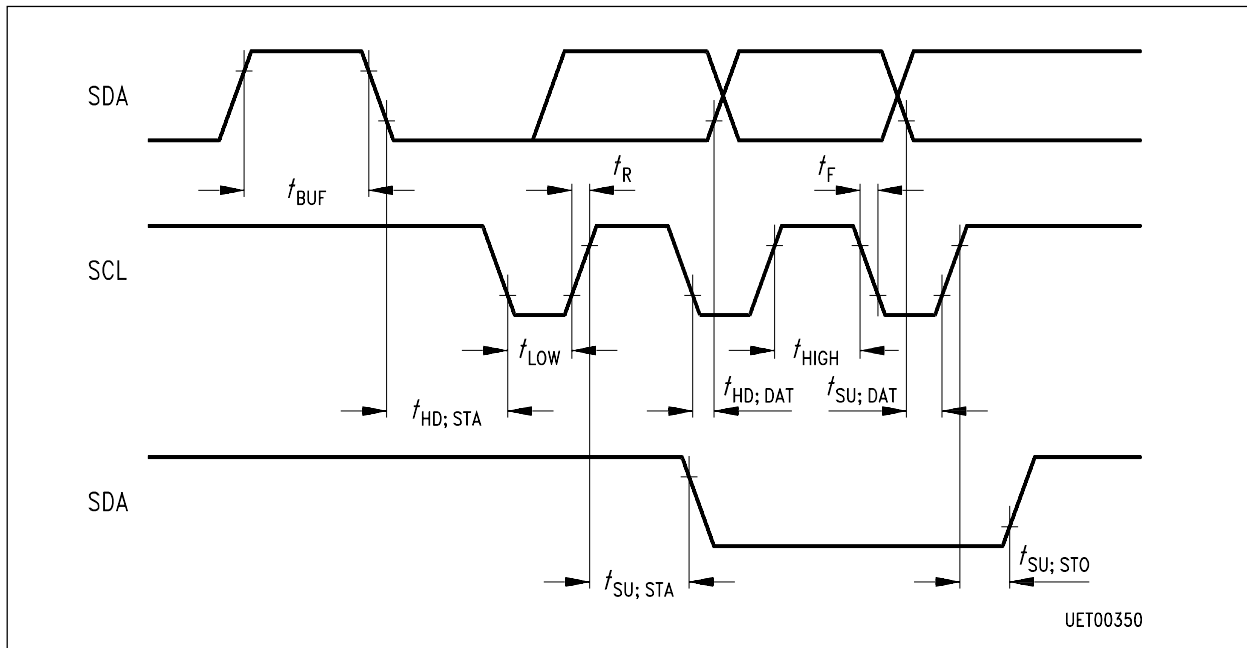

Figure 2
Timing Conditions for the I²C Bus (high-speed mode)

Parameter	Symbol	Limit Values		Unit
		min.	max.	
Minimum time the bus must be free before a new transmission can start	t_{BUF}	4.7		μs
Start condition hold time	$t_{HD; STA}$	4.0		μs
Clock low period	t_{LOW}	4.7		μs
Clock high period	t_{HIGH}	4.0		μs
Start condition set-up time, only valid for repeated start code	$t_{SU; STA}$	4.7		μs
Data set-up time	$t_{SU; DAT}$	250		ns
Rise time of both the SDA and SCL line	t_R		1	μs
Fall time of both the SDA and SCL line	t_F		300	ns
Stop condition set-up time	$t_{SU; STO}$	4.7		μs
Hold time data	$t_{HD; DAT}$	0*)		

*) Note that a transmitter must internally provide at least a hold time to bridge the undefined region (max. 300 ns) of the falling edge of SCL.

Figure 3

Programming

Control word input

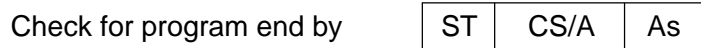
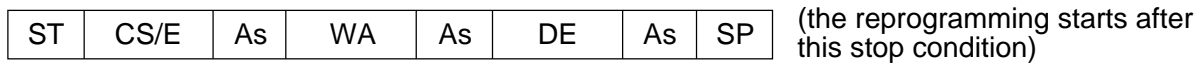

1. when As = 1 programming is not finished
2. when As = 0 programming is finished

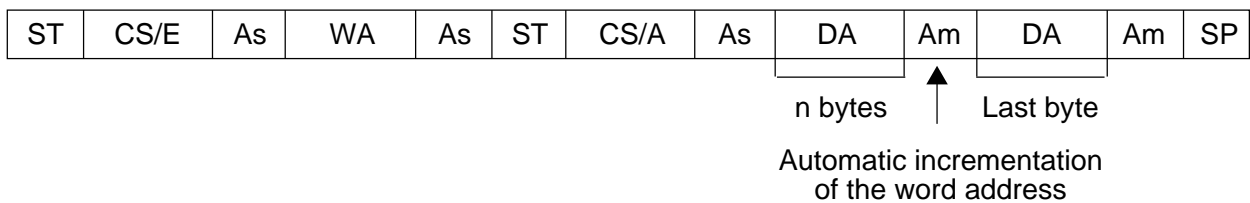

Figure 4

Read

Control word input read

a) complete (with word address input)



b) shortened:
Bit 0 ... 8 the last adapted word
address keep unchanged

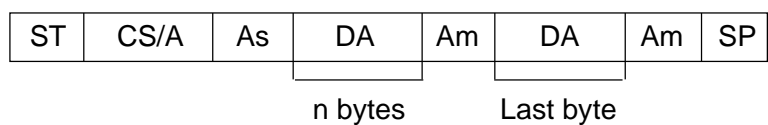

Autoincrement before stop condition Am = 0
Am = 1

Control Word Table

Clock No.	1	2	3	4	5	6	7	8	9	(Acknowledge)
CS/E	1	0	1	0	CS2	CS1	CS	0	0	through memory
CS/A	1	0	1	0	CS2	CS1	CS	1	0	through memory
WA	A7	A6	A5	A4	A3	A2	A1	A0	0	through memory
DE	D7	D6	D5	D4	D3	D2	D1	D0	0	through memory
DA	D7	D6	D5	D4	D3	D2	D1	D0	0/1	through master

Control Word Input Key

CS/E	Chip select for data input into memory
CS/A	Chip select for data output out of memory
WA	Memory word address
DE	Data word for memory
DA	Data word read out of memory
D0 to D7	Data bits
ST	Start condition
SP	Stop condition
As	Acknowledge bit from memory
Am	Acknowledge bit from master
CS	Chip select bit
A0 to A8	Memory word address bits