

Dual, Matched
 Picoampere, Microvolt Input,
 Low Noise Op Amp

FEATURES

- *Guaranteed* Offset Voltage 50µV Max.
- *Guaranteed* Bias Current 25°C 120pA Max.
 -55°C to 125°C 700pA Max.
- *Guaranteed* Drift 1.5µV/°C Max.
- Low Noise, 0.1Hz to 10Hz 0.5µVp-p
- *Guaranteed* Supply Current 600µA Max.
- *Guaranteed* CMRR 112dB Min.
- *Guaranteed* PSRR 112dB Min.
- *Guaranteed* Voltage Gain with 5mA Load Current
- *Guaranteed* Matching Characteristics

APPLICATIONS

- Strain Gauge Signal Conditioner
- Dual Limit Precision Threshold Detection
- Charge Integrators
- Wide Dynamic Range Logarithmic Amplifiers
- Light Meters
- Low Frequency Active Filters
- Standard Cell Buffers
- Thermocouple Amplifiers

DESCRIPTION

The LT1024 dual, matched internally compensated universal precision operational amplifier can be used in practically all precision applications requiring multiple op amps. The LT1024 combines picoampere bias currents (which are maintained over the full -55°C to 125°C temperature range), microvolt offset voltage (and low drift with time and temperature), low voltage and current noise, and low power dissipation. Extremely high common-mode and power supply rejection ratios, practically immeasurable warm-up drift, and the ability to deliver 5mA load current with a voltage gain of a million round out the LT1024's superb precision specifications.

Tight matching is guaranteed on offset voltage, non-inverting bias currents and common-mode and power supply rejections.

The all-around excellence of the LT1024 eliminates the necessity of the time-consuming error analysis procedure of precision system design in many dual applications; the LT1024 can be stocked as the universal dual op amp in the 14-pin DIP configuration.

For a single op amp with similar specifications, see the LT1012 data sheet; for a single supply dual precision op amp in the 8-pin configuration, see the LT1013 data sheet.

Two Op Amp Instrumentation Amplifier

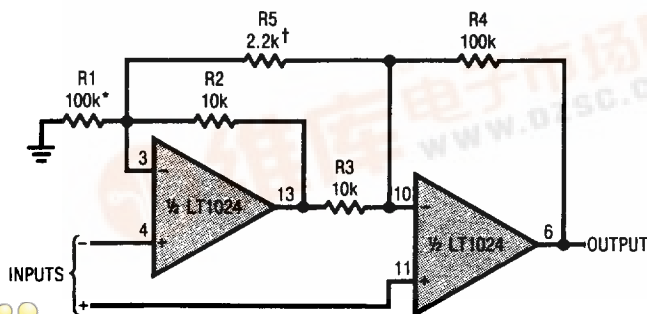

TYPICAL PERFORMANCE:
 OFFSET VOLTAGE = 20µV
 BIAS CURRENT = ±30pA
 OFFSET CURRENT = 30pA

Input Bias Current vs Temperature

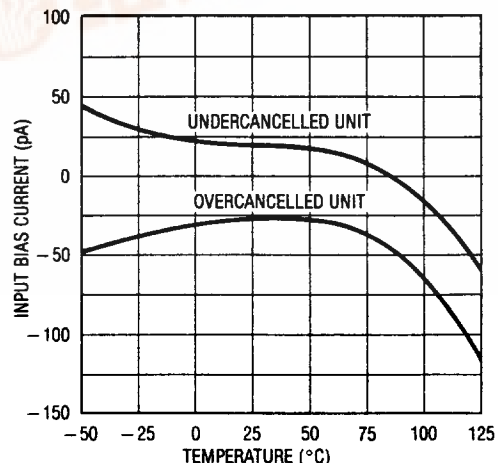

LT1024

ABSOLUTE MAXIMUM RATINGS

Supply Voltage	± 20V
Differential Input Current (Note 1)	± 10mA
Input Voltage	± 20V
Output Short Circuit Duration	Indefinite
Operating Temperature Range	
LT1024AM/LT1024M	− 55°C to 125°C
LT1024AC/LT1024C	0°C to 70°C
Storage Temperature Range	
All Devices	− 65°C to 150°C
Lead Temperature (Soldering, 10 sec.)	300°C

PACKAGE/ORDER INFORMATION

D PACKAGE
14 PIN HERMETIC
(SIDEBRAZED)

N PACKAGE
14 PIN PLASTIC

NOTE: DEVICE MAY BE OPERATED EVEN IF INSERTION IS REVERSED; THIS IS DUE TO INHERENT SYMMETRY OF PIN LOCATIONS OF AMPLIFIERS A AND B (NOTE 2).

ORDER PART NUMBER

LT1024AMD
LT1024MD
LT1024ACN
LT1024CN

ELECTRICAL CHARACTERISTICS $V_S = \pm 15V, V_{CM} = 0V, T_A = 25^\circ C$ unless otherwise noted

Individual Amplifiers

SYMBOL	PARAMETER	CONDITIONS	LT1024AM/LT1024AC			LT1024M/LT1024C			UNITS
			MIN	TYP	MAX	MIN	TYP	MAX	
V_{OS}	Input Offset Voltage			15	50		20	100	μV
	Long Term Input Offset Voltage Stability			0.3			0.3		$\mu V/\text{month}$
I_{OS}	Input Offset Current			20	100		25	180	pA
I_B	Input Bias Current			± 25	± 120		± 30	± 200	pA
e_n	Input Noise Voltage	0.1Hz to 10Hz		0.5			0.5		$\mu Vp-p$
e_n	Input Noise Voltage Density	$f_0 = 10\text{Hz}$ (Note 3)		17	33		17	33	$nV/\sqrt{\text{Hz}}$
		$f_0 = 1000\text{Hz}$ (Note 3)		14	24		14	24	$nV/\sqrt{\text{Hz}}$
i_n	Input Noise Current Density	$f_0 = 10\text{Hz}$		20			20		$fA/\sqrt{\text{Hz}}$
A_{VOL}	Large Signal Voltage Gain	$V_{OUT} = \pm 12V, R_L \geq 10k\Omega$	250	2000		180	2000		V/mV
		$V_{OUT} = \pm 10V, R_L \geq 2k\Omega$	150	1000		100	1000		V/mV
CMRR	Common-Mode Rejection Ratio	$V_{CM} = \pm 13.5V$	112	132		108	132		dB
PSRR	Power Supply Rejection Ratio	$V_S = \pm 2V$ to $\pm 20V$	112	132		108	132		dB
	Input Voltage Range		± 13.5	± 14.0		± 13.5	± 14.0		V
V_{OUT}	Output Voltage Swing	$R_L = 10k\Omega$	± 13	± 14		± 13	± 14		V
	Slew Rate		0.1	0.2		0.1	0.2		V/ μS
I_S	Supply Current per Amplifier			380	600		380	700	μA

Matching Specifications

SYMBOL	PARAMETER	CONDITIONS	LT1024AM/LT1024AC			LT1024M/LT1024C			UNITS
			MIN	TYP	MAX	MIN	TYP	MAX	
	Input Offset Voltage Match		—	20	75	—	25	150	μV
I_B^+	Average Non-Inverting Bias Current		—	± 30	± 150	—	± 40	± 250	pA
I_{OS}^+	Non-Inverting Offset Current		—	30	150	—	30	300	pA
ΔCMRR	Common Mode Rejection Ratio Match	$V_{CM} = \pm 13.5V$	110	132	—	106	132	—	dB
ΔPSRR	Power Supply Rejection Ratio Match	$V_S = \pm 2V$ to $20V$	110	132	—	106	132	—	dB
	Channel Separation	$f \leq 10\text{Hz}$ (Note 3)	134	150	—	134	150	—	dB

ELECTRICAL CHARACTERISTICS

$V_S = \pm 15V$, $V_{CM} = 0V$, $0^\circ C \leq T_A \leq 70^\circ C$ for the LT1024AC and LT1024C;
 $-55^\circ C \leq T_A \leq 125^\circ C$ for the LT1024AM and LT1024M unless otherwise noted

Individual Amplifiers

SYMBOL	PARAMETER	CONDITIONS	LT1024AM/LT1024AC			LT1024M/LT1024C			UNITS
			MIN	TYP	MAX	MIN	TYP	MAX	
V_{OS}	Input Offset Voltage	$0^\circ C$ to $70^\circ C$ $-55^\circ C$ to $125^\circ C$	●	30	120	35	200	μV	
			●	40	200	50	300	μV	
	Average Temperature Coefficient of Input Offset Voltage		●	0.25	1.5	0.3	2.0	$\mu V/^\circ C$	
I_{OS}	Input Offset Current	$0^\circ C$ to $70^\circ C$ $-55^\circ C$ to $125^\circ C$	●	40	250	50	300	pA	
			●	80	350	100	500	pA	
	Average Temperature Coefficient of Input Offset Current		●	0.5	2.5	0.7	3	pA/°C	
I_B	Input Bias Current	$0^\circ C$ to $70^\circ C$ $-55^\circ C$ to $125^\circ C$	●	± 40	± 250	± 50	± 400	pA	
			●	± 100	± 700	± 200	± 1300	pA	
	Average Temperature Coefficient of Input Bias Current		●	0.4	3	0.5	4	pA/°C	
			●	1	6	2	12	pA/°C	
A_{VOL}	Large Signal Voltage Gain	$V_{OUT} = \pm 12V$, $R_L \geq 10k\Omega$ $V_{OUT} = \pm 10V$, $R_L \geq 2k\Omega$	●	150	1000	150	1000	V/mV	
			●	100	600	100	600	V/mV	
CMRR	Common-Mode Rejection Ratio	$V_{CM} = \pm 13.5V$	●	108	128	106	128	dB	
PSRR	Power Supply Rejection Ratio	$V_S = \pm 2.5V$ to $\pm 18V$	●	108	128	106	128	dB	
	Input Voltage Range		●	± 13.5		± 13.5		V	
V_{OUT}	Output Voltage Swing	$R_L = 10k\Omega$	●	± 13	± 14	± 13	± 14	V	
I_S	Supply Current		●	400	800	400	900	μA	

2

Matching Specifications

SYMBOL	PARAMETER	CONDITIONS	LT1024AM/LT1024AC			LT1024M/LT1024C			UNITS	
			MIN	TYP	MAX	MIN	TYP	MAX		
	Input Offset Voltage Match	$0^\circ C$ to $70^\circ C$ $-55^\circ C$ to $125^\circ C$	●	35	170	45	300	μV		
●			—	50	280	—	70	500	μV	
	Input Offset Voltage Tracking		●	—	0.3	2.0	—	0.4	3.5	$\mu V/^\circ C$
I_B^+	Average Non-Inverting Bias Current	$0^\circ C$ to $70^\circ C$ $-55^\circ C$ to $125^\circ C$	●	± 40	± 300	± 50	± 500	pA		
			●	—	± 100	± 800	—	± 200	± 1400	pA
I_{OS}^+	Non-Inverting Offset Current	$0^\circ C$ to $70^\circ C$ $-55^\circ C$ to $125^\circ C$	●	—	40	300	—	50	500	pA
			●	—	80	800	—	150	1500	pA
$\Delta CMRR$	Common-Mode Rejection Ratio Match	$V_{CM} = \pm 13.5V$	●	106	128	—	104	128	—	dB
$\Delta PSRR$	Power Supply Rejection Ratio Match	$V_S = \pm 2.5V$ to $\pm 18V$	●	106	128	—	104	128	—	dB

The ● denotes the specifications which apply over the full operating temperature range.

Note 1: Differential input voltages greater than 1V will cause excessive current to flow through the input protection diodes unless limiting resistance is used.

Note 2: The V^+ supply terminals are completely independent and may be powered by separate supplies if desired (this approach, however, would sacrifice the advantages of the power supply rejection ratio matching). The V^- supply terminals are both connected to the common substrate and must be tied to the same voltage. Both V^- pins should be used.

Note 3: This parameter is tested on a sample basis only.

Optional Offset Nulling Circuit

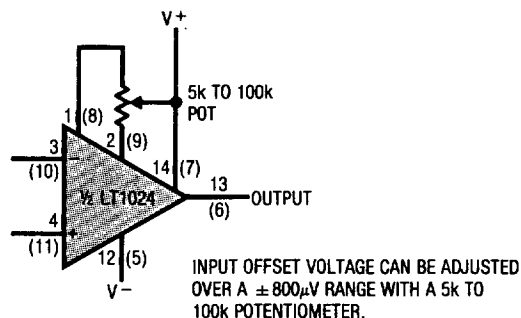

TYPICAL PERFORMANCE CHARACTERISTICS

Offset Voltage vs Source Resistance (Balanced or Unbalanced)

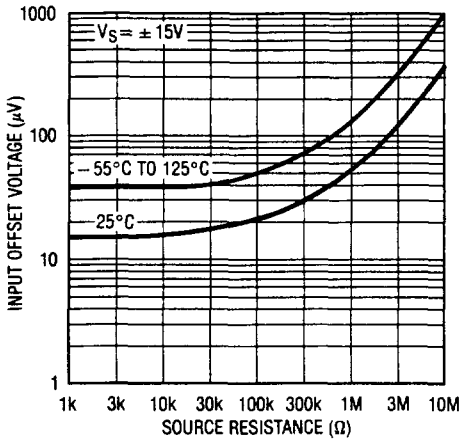

Input Offset Current vs Temperature

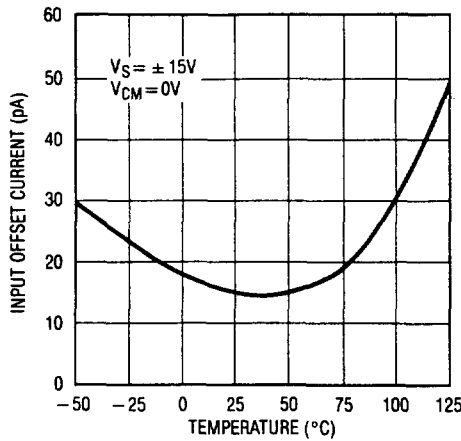

Input Bias Current Over Common-Mode Range

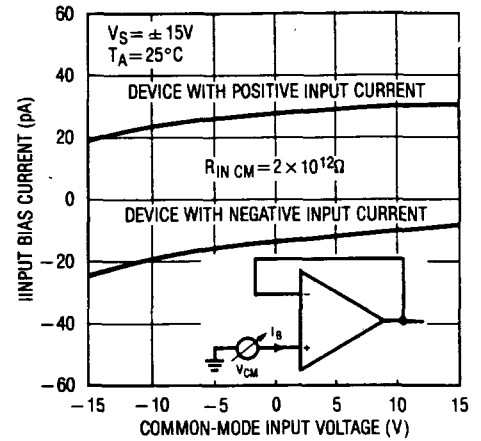

Warm-Up Drift

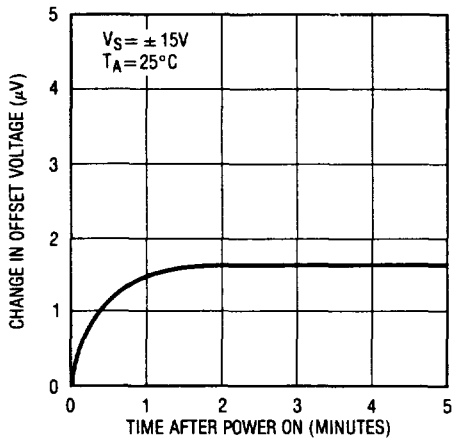

Offset Voltage Drift and Tracking with Temperature of Representative Units

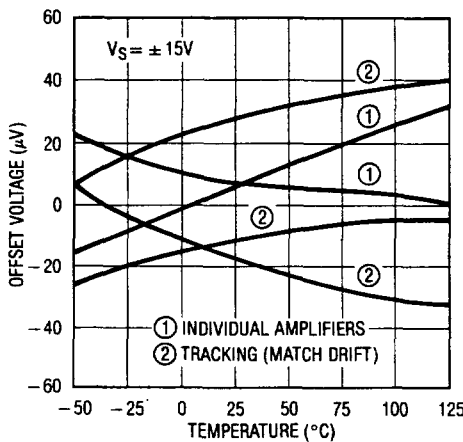

Supply Current vs Supply Voltage per Amplifier

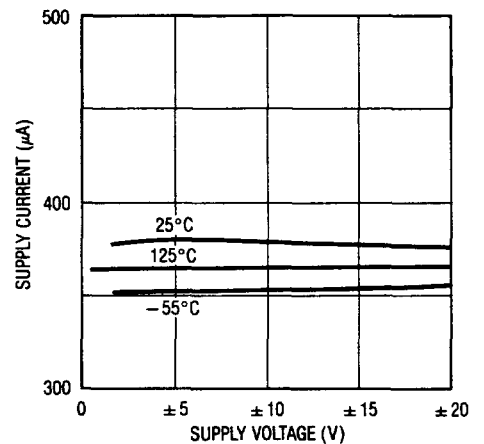

0.1Hz to 10Hz Noise

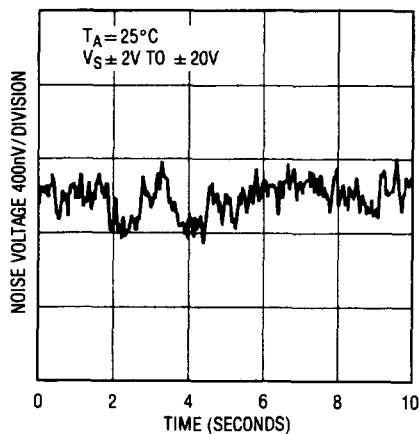

Noise Spectrum

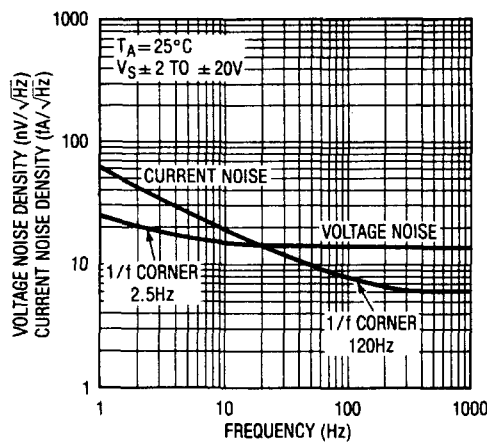

Total Noise vs Source Resistance

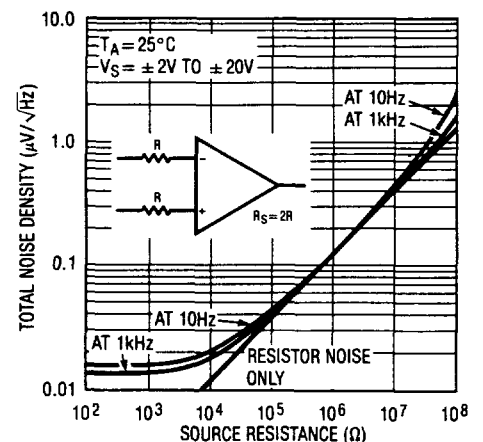

TYPICAL PERFORMANCE CHARACTERISTICS

Common-Mode Rejection and CMRR Match vs Frequency

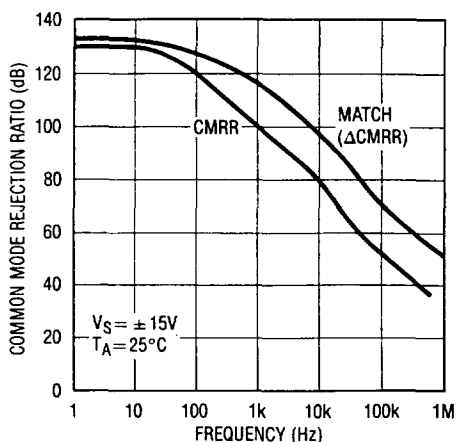

Power Supply Rejection vs Frequency

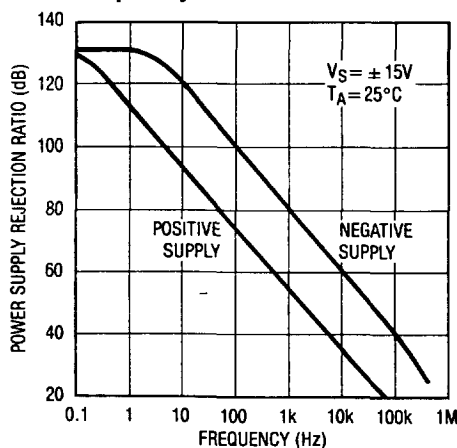

Channel Separation vs Frequency

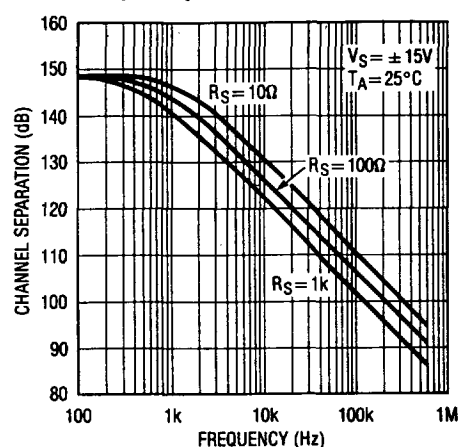

2

Voltage Gain vs Frequency

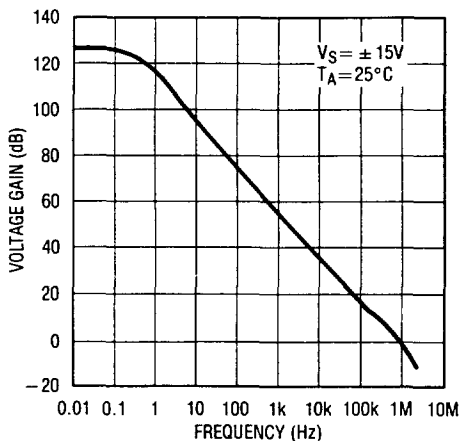

Gain, Phase Shift vs Frequency

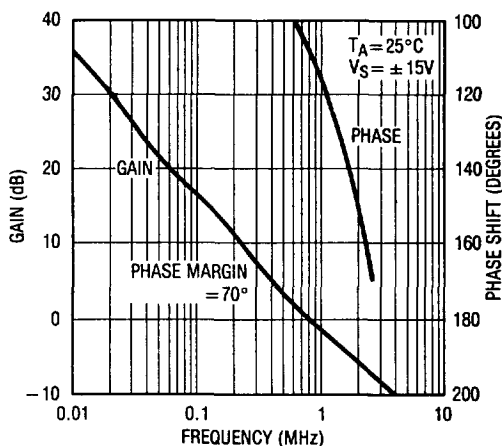

Voltage Gain vs Load Resistance

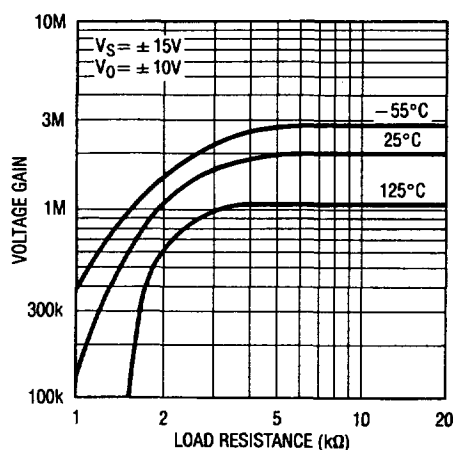

Small Signal Transient Response

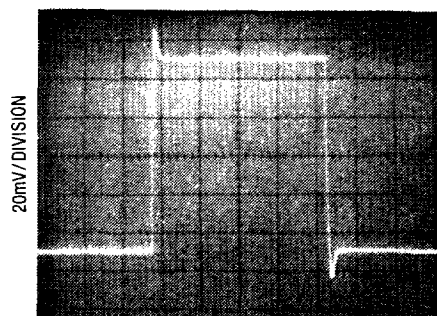

$A_V = +1, C_{LOAD} = 100pF, 5\mu sec/DIV$

Small Signal Transient Response

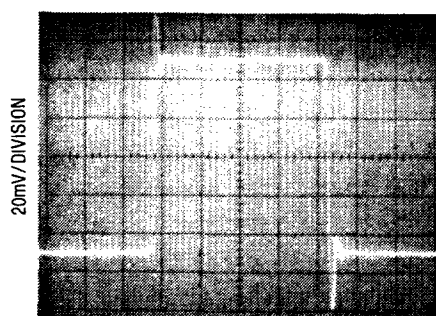

$A_V = +1, C_{LOAD} = 1000pF, 5\mu sec/DIV$

Large Signal Transient Response

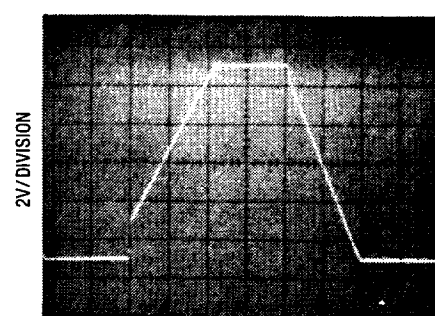

$A_V = +1, 20\mu sec/DIV$

APPLICATIONS INFORMATION

The LT1024 may be inserted directly into OP-10, OP-207 or OP227 sockets with or without removal of external nulling components.

The LT1024 is specified over a wide range of power supply voltages from $\pm 2V$ to $\pm 18V$. Operation with lower supplies is possible down to $\pm 1.2V$ (two NiCad batteries).

Advantages of Matched Dual Op Amps

In many applications, the performance of a system depends on the matching between two operational amplifiers rather than the individual characteristics of the two op amps. Two or three op amp instrumentation amplifiers, tracking voltage references, and low drift active filters are some of the circuits requiring matching between two op amps.

The well-known triple op amp configuration illustrates these concepts. Output offset is a function of the difference between the offsets of the two halves of the LT1024. This error cancellation principle holds for a considerable number of input-referred parameters in addition to offset voltage and its drift with temperature. Input bias current will be the average of the two non-inverting input currents (I_B^+). The difference between these two cur-

rents (I_{OS}^+) is the offset current of the instrumentation amplifier. Common-mode and power supply rejections will be dependent only on the match between the two amplifiers (assuming perfect resistor matching).

The concepts of common-mode and power supply rejection ratio match ($\Delta CMRR$ and $\Delta PSRR$) are best demonstrated with a numerical example:

Assume $CMRR_A = +1.0\mu V/V$ or 120dB
 and $CMRR_B = +0.5\mu V/V$ or 126dB,
 then $\Delta CMRR = 0.5\mu V/V$ or 126dB
 if $CMRR_B = -0.5\mu V/V$, which is still 126dB,
 then $\Delta CMRR = 1.5\mu V/V$ or 116.5dB.

Typical performance of the instrumentation amplifier:

Input offset voltage = $25\mu V$.

Input bias current = $30pA$.

Input resistance = $10^{12}\Omega$.

Input offset current = $30pA$.

Input noise = $0.7\mu V p-p$.

Power bandwidth ($V_0 = \pm 10V$) = 80kHz.

Clearly, the LT1024, by specifying and guaranteeing all of these matching parameters, can significantly improve the performance of matching dependent circuits.

Three Op Amp Instrumentation Amplifier

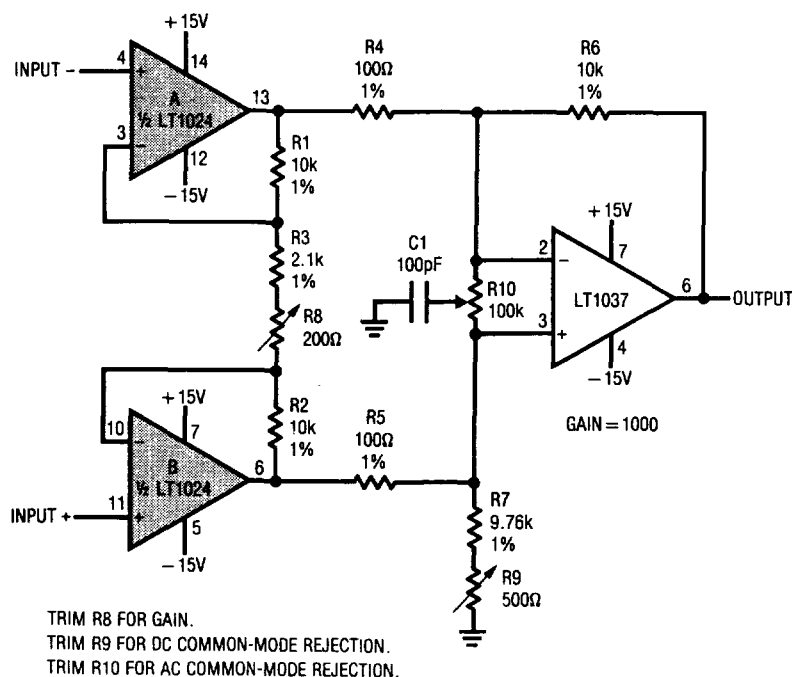

APPLICATIONS INFORMATION

Achieving Picoampere/Microvolt Performance

In order to realize the picoampere/microvolt level accuracy of the LT1024, proper care must be exercised. For example, leakage currents in circuitry external to the op amp can significantly degrade performance. High quality insulation should be used (e.g., Teflon, Kel-F); cleaning of all insulating surfaces to remove fluxes and other residues will probably be required. Surface coating may be necessary to provide a moisture barrier in high humidity environments.

Board leakage can be minimized by encircling the input circuitry with a guard ring operated at a potential close to that of the inputs: in inverting configurations, the guard ring should be tied to ground, in non-inverting connections, to the inverting input. Guarding both sides of the printed circuit board is required. Bulk leakage reduction depends on the guard ring width. Nanoampere level leakage into the offset trim terminals can affect offset voltage and drift with temperature.

Microvolt level error voltages can also be generated in the external circuitry. Thermocouple effects caused by temperature gradients across dissimilar metals at the contacts to the input terminals can exceed the inherent drift of the amplifier. Air currents over device leads should be minimized, package leads should be short, and the two input leads should be as close together as possible and maintained at the same temperature.

Test Circuit for Offset Voltage and its Drift with Temperature

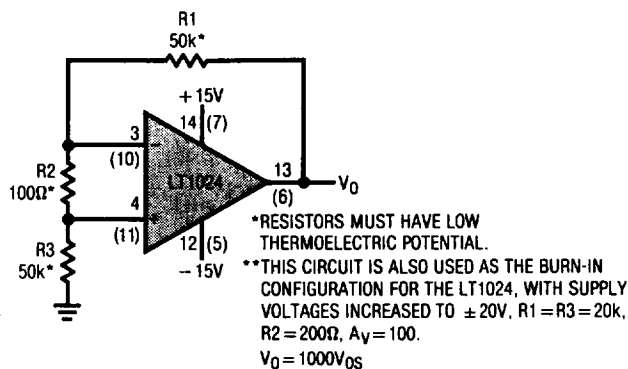

2

Direct Pressure Transducer to Digital Output Signal Conditioner

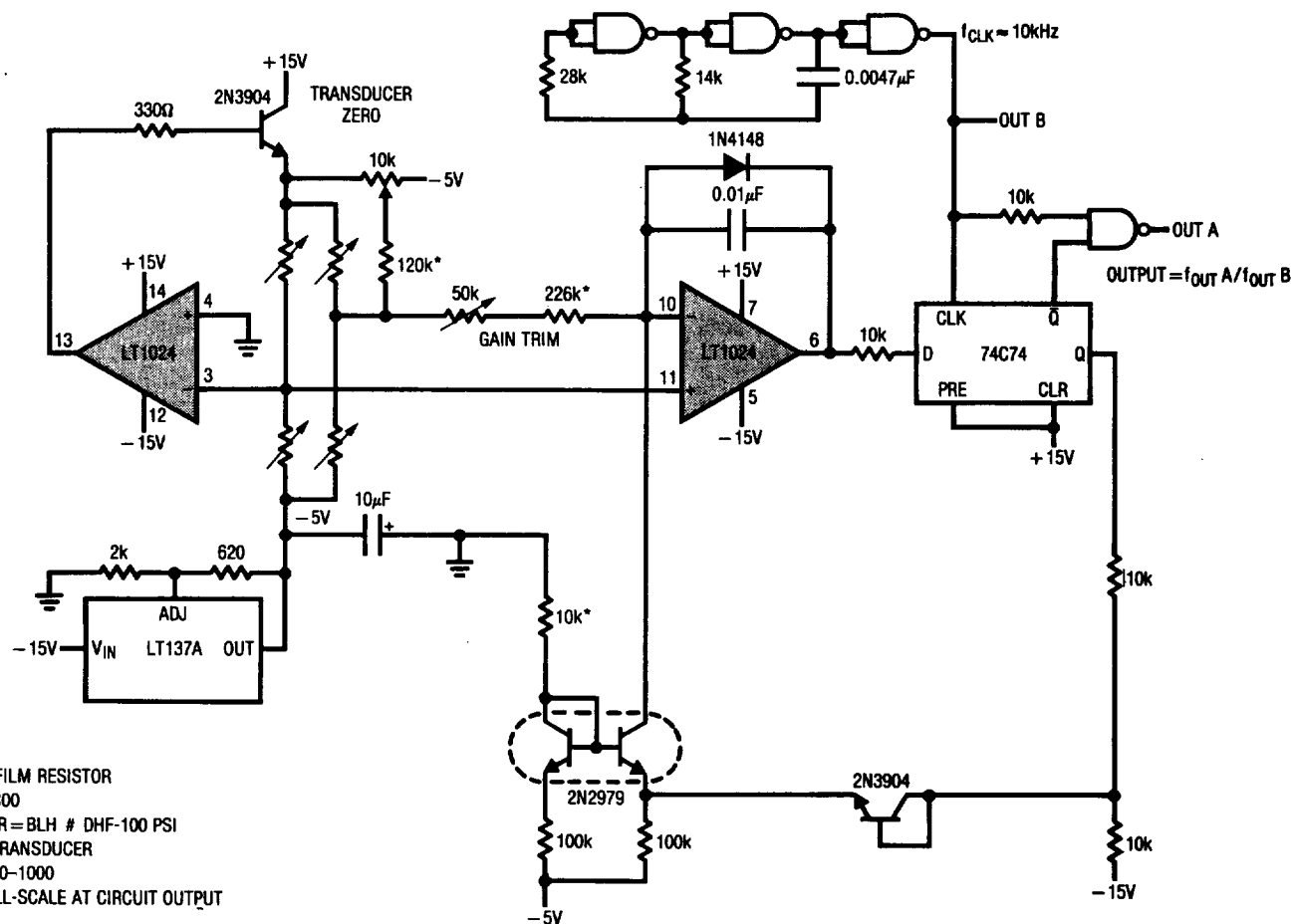

*1% METAL FILM RESISTOR
 GATES = 74C00
 TRANSDUCER = BLH # DHF-100 PSI
 PRESSURE TRANSDUCER
 0-100 PSI = 0-1000
 COUNTS FULL-SCALE AT CIRCUIT OUTPUT

LT1024

SCHEMATIC DIAGRAM

1/2 LT1024

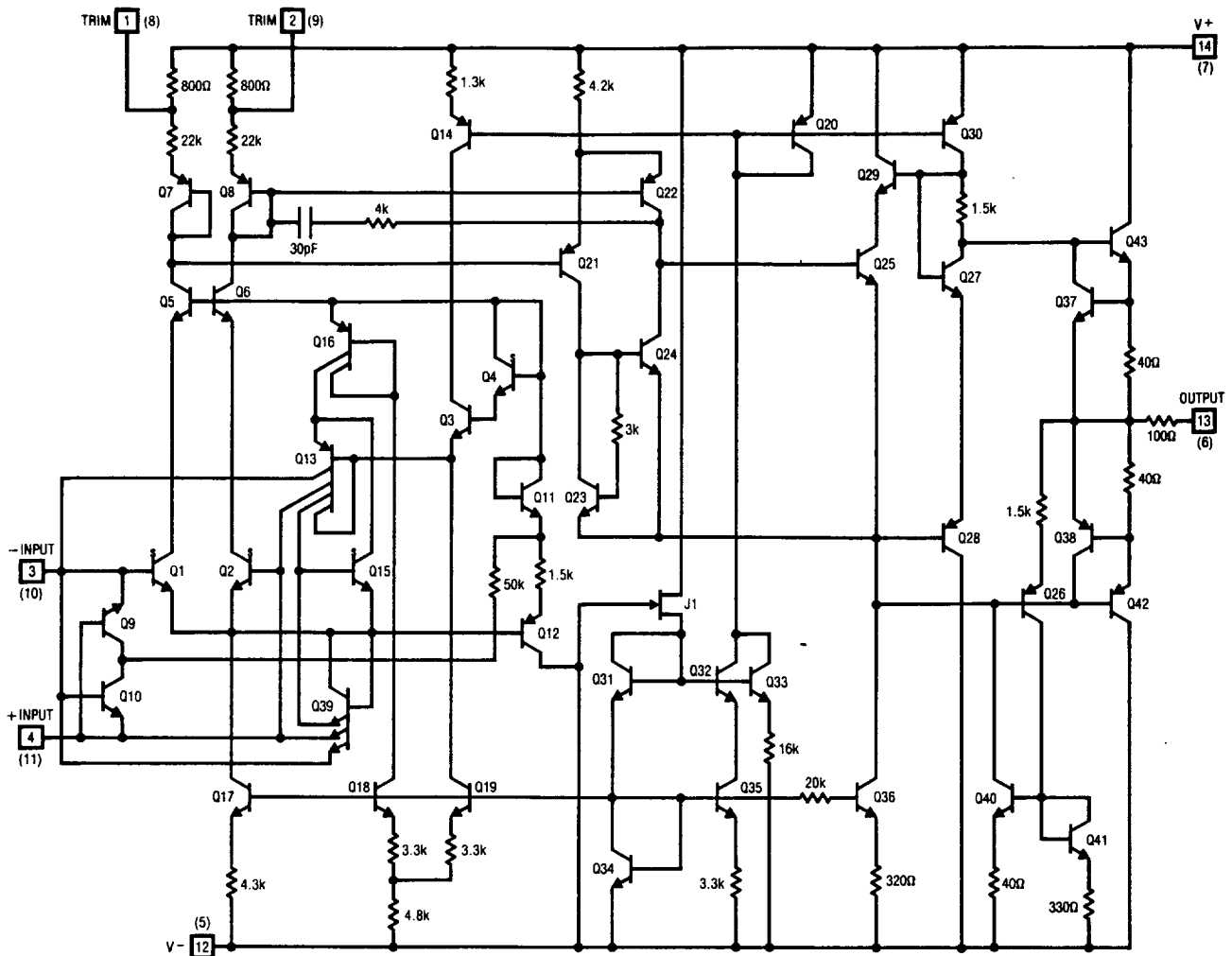

PACKAGE DESCRIPTION

D14 Package 14-Lead Hermetic DIP (Sidebrazed)

N14 Package 14-Lead Plastic

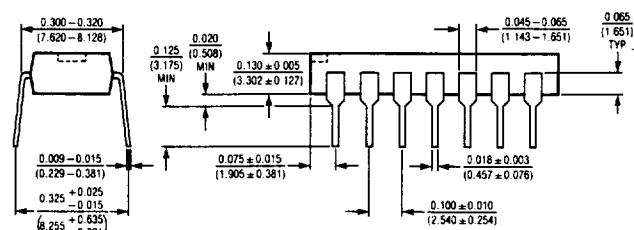
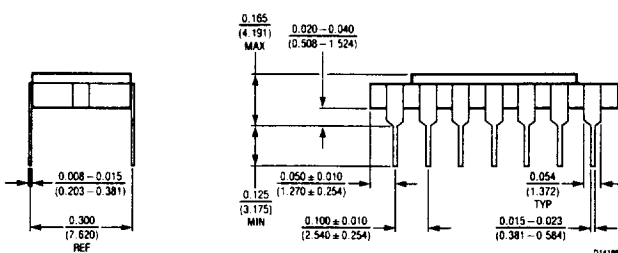
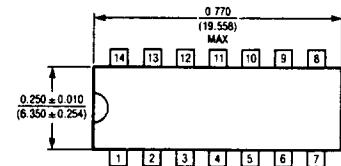
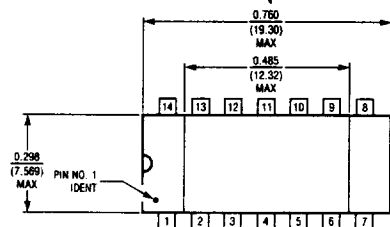

T_{JMAX}	θ_{JA}	θ_{JC}
150°C	100°C/W	60°C/W

T_{JMAX}	θ_{JA}	θ_{JC}
100°C	100°C/W	60°C/W