



MBRB1530CT–MBRB1545CT

Vishay Lite-On Power Semiconductor

15A Surface Mount Schottky Barrier Rectifiers

Features

- Schottky barrier chip
- Guard ring die construction for transient protection
- Low power loss, high efficiency
- High surge capability
- High current capability and low forward voltage drop
- Surge overload rating to 150A peak
- For use in low voltage, high frequency inverters, free wheeling, and polarity protection application
- Plastic material – UL Recognition flammability classification 94V-0

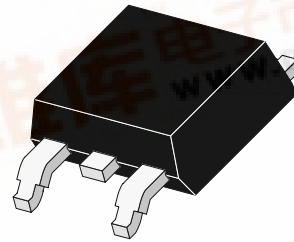

14455

Absolute Maximum Ratings

T_j = 25°C

Parameter	Test Conditions	Type	Symbol	Value	Unit
Repetitive peak reverse voltage =Working peak reverse voltage =DC Blocking voltage		MBRB1530CT	V _R RM	30	V
		MBRB1535CT	=V _R WM	35	V
		MBRB1540CT	=V _R	40	V
		MBRB1545CT		45	V
Peak forward surge current	t _p =8.3ms, half sinewave		I _F SM	150	A
Average forward current	T _C =105°C		I _F AV	15	A
Junction and storage temperature range			T _j =T _{stg}	-65...+150	°C

Electrical Characteristics

T_j = 25°C

Parameter	Test Conditions	Type	Symbol	Min	Typ	Max	Unit
Forward voltage	I _F =7.5A		V _F			0.7	V
Reverse current	V _R =V _R RM		I _R			0.1	mA
	T _j =100°C, V _R =V _R RM		I _R			15	mA
Diode capacitance	V _R =4V, f=1MHz		C _D		250		pF
Thermal resistance junction to case			R _{th} JC		3.0		K/W
Voltage rate of change (Rated V _R)	300µs pulse width, 2% duty cycle		dV/dt			10000	V/µs

MBRB1530CT–MBRB1545CT

Vishay Lite-On Power Semiconductor



Characteristics (T_j = 25°C unless otherwise specified)

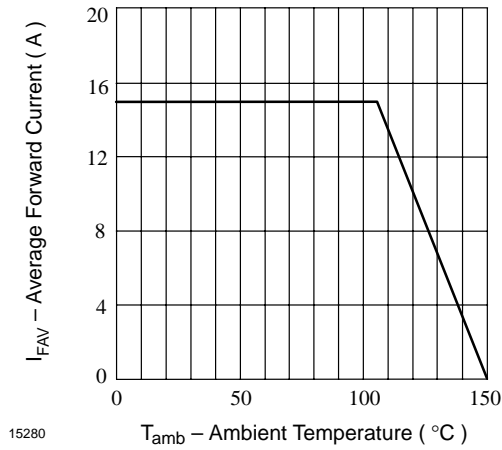

Figure 1. Max. Average Forward Current vs. Ambient Temperature

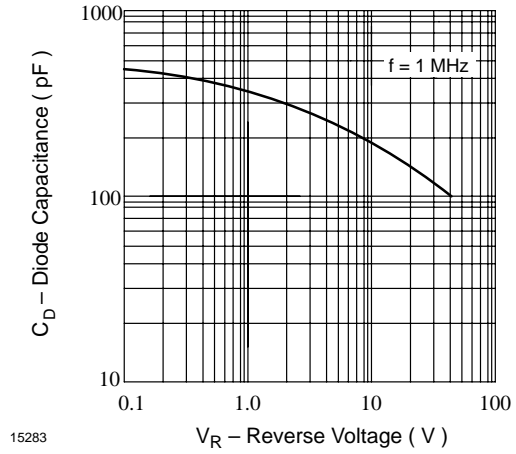

Figure 4. Typ. Diode Capacitance vs. Reverse Voltage

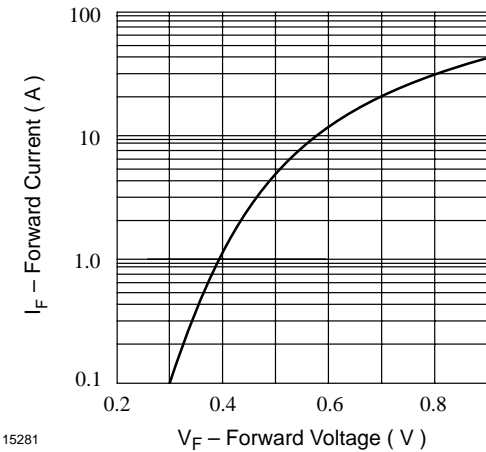

Figure 2. Typ. Forward Current vs. Forward Voltage

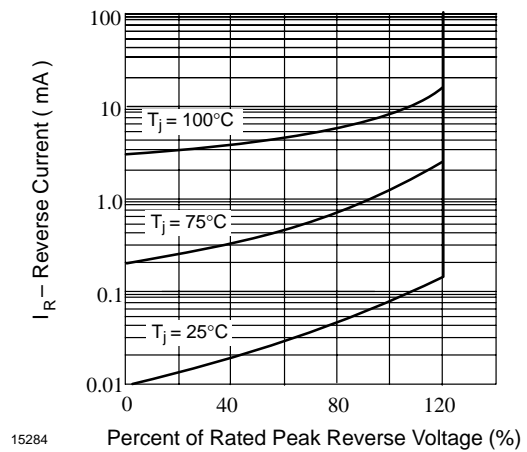

Figure 5. Typ. Reverse Current vs. Percent of Rated Peak Reverse Voltage

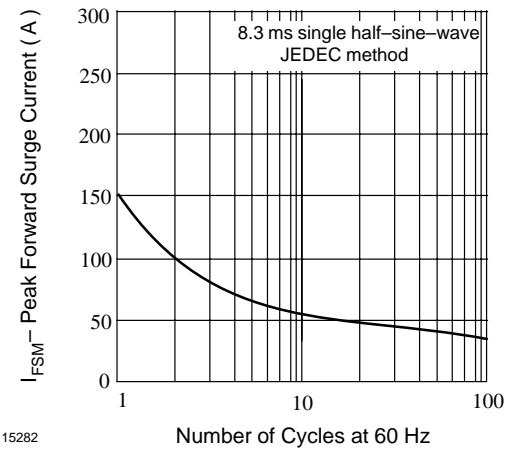

Figure 3. Max. Peak Forward Surge Current vs. Number of Cycles



MBRB1530CT–MBRB1545CT

Vishay Lite-On Power Semiconductor

Dimensions in mm

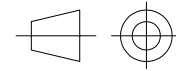
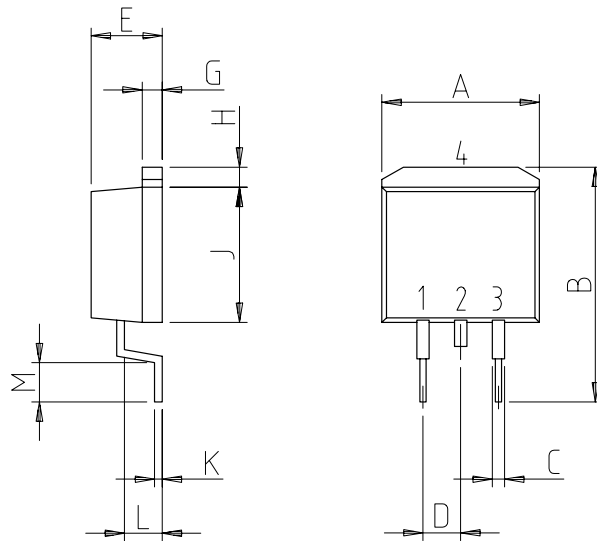

technical drawings
according to DIN
specifications

14457

D ² PAK		
Dim	Min	Max
A	9.65	10.69
B	14.60	15.88
C	0.51	1.14
D	2.29	2.79
E	4.37	4.83
G	1.14	1.40
H	1.14	1.40
J	8.25	9.25
K	0.30	0.64
L	2.03	2.92
M	2.29	2.79
All Dimensions in mm		

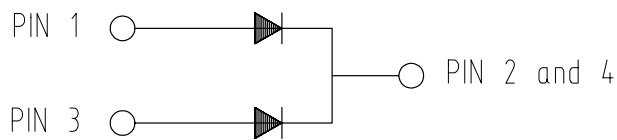

Case: D2- PAK molded plastic
Polarity: see diagram
Approx. weight: 1.7 grams
Mounting position: any
Marking: type number



Ozone Depleting Substances Policy Statement

It is the policy of **Vishay Semiconductor GmbH** to

1. Meet all present and future national and international statutory requirements.
2. Regularly and continuously improve the performance of our products, processes, distribution and operating systems with respect to their impact on the health and safety of our employees and the public, as well as their impact on the environment.

It is particular concern to control or eliminate releases of those substances into the atmosphere which are known as ozone depleting substances (ODSs).

The Montreal Protocol (1987) and its London Amendments (1990) intend to severely restrict the use of ODSs and forbid their use within the next ten years. Various national and international initiatives are pressing for an earlier ban on these substances.

Vishay Semiconductor GmbH has been able to use its policy of continuous improvements to eliminate the use of ODSs listed in the following documents.

1. Annex A, B and list of transitional substances of the Montreal Protocol and the London Amendments respectively
2. Class I and II ozone depleting substances in the Clean Air Act Amendments of 1990 by the Environmental Protection Agency (EPA) in the USA
3. Council Decision 88/540/EEC and 91/690/EEC Annex A, B and C (transitional substances) respectively.

Vishay Semiconductor GmbH can certify that our semiconductors are not manufactured with ozone depleting substances and do not contain such substances.

We reserve the right to make changes to improve technical design and may do so without further notice.

Parameters can vary in different applications. All operating parameters must be validated for each customer application by the customer. Should the buyer use Vishay-Telefunken products for any unintended or unauthorized application, the buyer shall indemnify Vishay-Telefunken against all claims, costs, damages, and expenses, arising out of, directly or indirectly, any claim of personal damage, injury or death associated with such unintended or unauthorized use.

Vishay Semiconductor GmbH, P.O.B. 3535, D-74025 Heilbronn, Germany
Telephone: 49 (0) 7131 67 2831, Fax number: 49 (0) 7131 67 2423