

3A. Negative Adjustable Regulator

FEATURES

- *Guaranteed* 1% Initial Voltage Tolerance
- *Guaranteed* 0.015%/V Line Regulation
- *Guaranteed* 0.02%/W Thermal Regulation
- 100% Burn-in in Thermal Limit

APPLICATIONS

- Adjustable Power Supplies
- System Power Supplies
- Precision Voltage/Current Regulators
- On-Card Regulators

DESCRIPTION

The LT1033 negative adjustable regulator will deliver up to 3 Amps output current over an output voltage range of -1.2V to -32V . Linear Technology has made significant improvements in these regulators compared to previous devices, such as better line and load regulation, and a maximum output voltage error of 1%.

The LT1033 is easy to use and difficult to damage. Internal current and power limiting as well as true thermal limiting prevents device damage due to overloads or shorts, even if the regulator is not fastened to a heat sink.

Maximum reliability is attained with Linear Technology's advanced processing techniques combined with a 100% burn-in in the thermal limit mode. This assures that all device protection circuits are working and eliminates field failures experienced with other regulators that receive only standard electrical testing.

4

Precision Regulator †

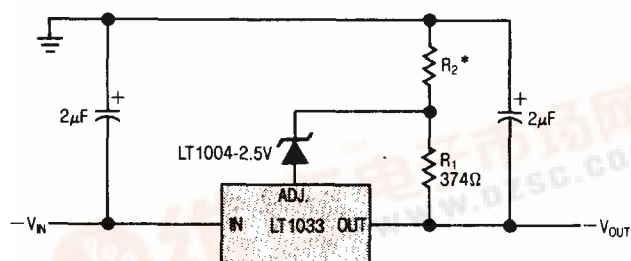

IMPROVED LINE & LOAD REGULATION **

$$* R_2 = \frac{R_1}{3.75} (V_{OUT} - 3.75)$$

** REGULATION IS IMPROVED BY $\frac{V_{OUT}}{1.25}$
 † EXTERNAL LT1004 REFERENCE IMPROVES LINE, LOAD, AND THERMAL REGULATION

Current Limit

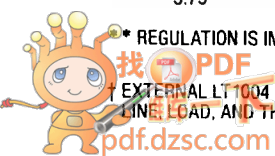
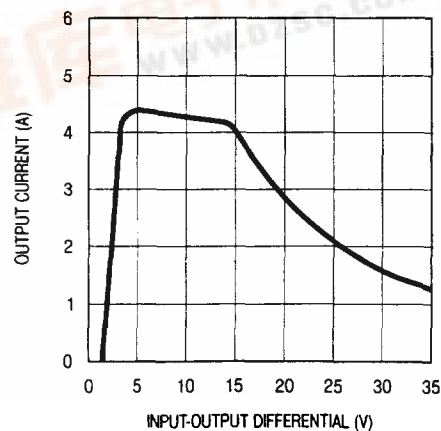

找PDF

EXTERNAL LT1004 REFERENCE IMPROVES LINE, LOAD, AND THERMAL REGULATION

pdf.dzsc.com

LT1033

ABSOLUTE MAXIMUM RATINGS

Power Dissipation	Internally Limited
Input to Output Voltage Differential	35V
Operating Junction Temperature Range	
LT1033M	−55°C to 150°C
LT1033C	0°C to 125°C
Storage Temperature Range	
LT1033M	−65°C to 150°C
LT1033C	−65°C to 150°C
Lead Temperature (Soldering, 10 sec.)	300°C

PRECONDITIONING

100% THERMAL LIMIT BURN-IN

PACKAGE/ORDER INFORMATION

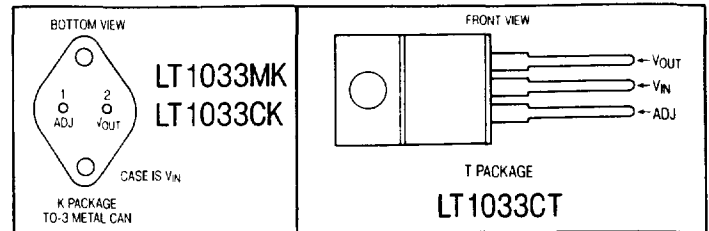

ELECTRICAL CHARACTERISTICS (See Note 1)

SYMBOL	PARAMETER	CONDITIONS	LT1033M			LT1033C			UNITS	
			MIN	TYP	MAX	MIN	TYP	MAX		
V_{REF}	Reference Voltage	$ V_{IN} - V_{OUT} = 5V, I_{OUT} = 5mA, T_j = 25^\circ C$	−1.238	−1.250	−1.262	−1.238	−1.250	−1.262	V	
		$3V \leq V_{IN} - V_{OUT} \leq 35V$ $5mA \leq I_{OUT} \leq I_{MAX}, P \leq P_{MAX}$	●	−1.215	−1.250	−1.285	−1.200	−1.250	−1.300	V
$\frac{\Delta V_{OUT}}{\Delta I_{OUT}}$	Load Regulation	$10mA \leq I_{OUT} \leq I_{MAX}$, (See Note 2) $T_j = 25^\circ C, V_{OUT} \leq 5V$		10	50	10	50		mV	
		$T_j = 25^\circ C, V_{OUT} \geq 5V$		0.2	1.0	0.2	1.0		%	
		$ V_{OUT} \leq 5V$	●	20	75	20	75		mV	
		$ V_{OUT} \geq 5V$	●	0.4	1.5	0.4	1.5		%	
$\frac{\Delta V_{OUT}}{\Delta V_{IN}}$	Line Regulation	$3V \leq V_{IN} - V_{OUT} \leq 35V$, (See Note 2) $T_j = 25^\circ C$	●	0.005	0.015	0.01	0.02		%/V	
				0.01	0.04	0.02	0.05		%/V	
	Ripple Rejection	$V_{OUT} = -10V, f = 120Hz$ $C_{ADJ} = 0$ $C_{ADJ} = 10\mu F$	56	66		60			dB	
			70	80		66	77		dB	
	Thermal Regulation	$T_j = 25^\circ C, 10msec$ Pulse		0.002	0.02	0.002	0.02		%/W	
I_{ADJ}	Adjust Pin Current		●	65	100	65	100		μA	
ΔI_{ADJ}	Adjust Pin Current Change	$10mA \leq I_{OUT} \leq I_{MAX}$	●	0.2	2	0.5	2		μA	
		$3V \leq V_{IN} - V_{OUT} \leq 35V$	●	1.0	5	2	5		μA	
	Minimum Load Current	$ V_{IN} - V_{OUT} \leq 35V$		2.5	5.0	2.5	5.0		mA	
		$ V_{IN} - V_{OUT} \leq 10V$		1.2	3.0	1.2	3.0		mA	
I_{SC}	Current Limit	$ V_{IN} - V_{OUT} \leq 10V$, (See Note 2)		3	4.3	6	3	4.3	6	A
		$ V_{IN} - V_{OUT} = 35V, T_j = 25^\circ C$		0.5	1.3	2.5	.5	1.3	2.5	A
$\frac{\Delta V_{OUT}}{\Delta Temp}$	Temperature Stability of Output Voltage	$T_{MIN} \leq T \leq T_{MAX}$	●	0.6	1.5	0.6	1.5		%	
$\frac{\Delta V_{OUT}}{\Delta Time}$	Long Term Stability	$T_A = 125^\circ C, 1000$ Hours		0.3	1.0	0.3	1.0		%	
e_n	RMS Output Noise (% of V_{OUT})	$T_A = 25^\circ C, 10Hz \leq f \leq 10kHz$		0.003		0.003			%	
θ_{JC}	Thermal Resistance Junction to Case	T Package				4			$^\circ C/W$	
		K Package		1.2	2.0	1.2	2.0		$^\circ C/W$	

The ● denotes the specifications which apply over the full operating temperature range. Otherwise $T_j = 25^\circ C$.

Note 1: Unless otherwise indicated, these specifications apply: $|V_{IN} - V_{OUT}| = 5V$; and $I_{OUT} = 5mA$. Power dissipation is internally limited. However, these specifications apply for power dissipation up to 30W. See guaranteed minimum output current curve. $I_{MAX} = 3A$.

Note 2: Testing is done using a pulsed low duty cycle technique. See thermal regulation specifications for output changes due to heating effects. Load regulation is measured on the output pin at a point 1/8" below the base of the package.

TYPICAL PERFORMANCE CHARACTERISTICS

Dropout Voltage

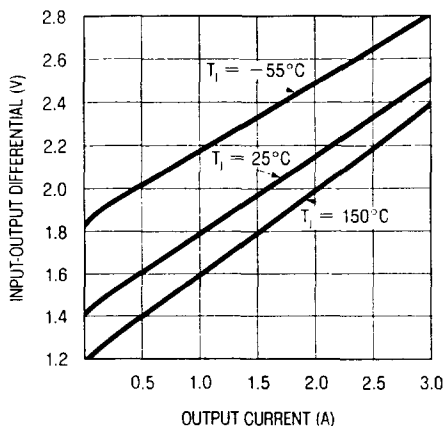

Temperature Stability

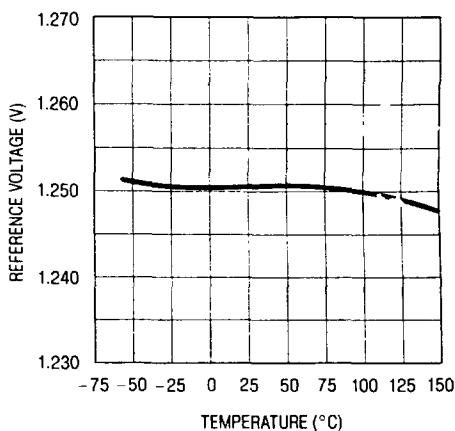

Minimum Load Current

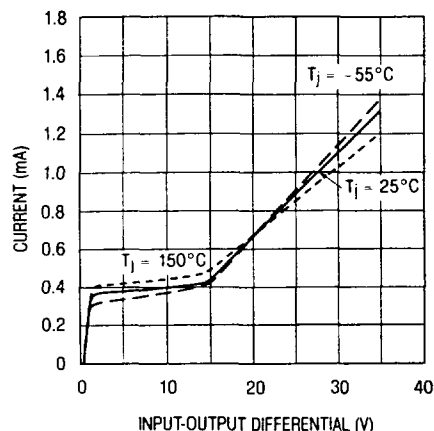

Ripple Rejection

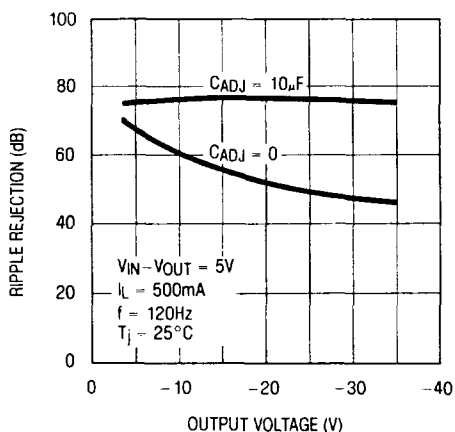

Ripple Rejection

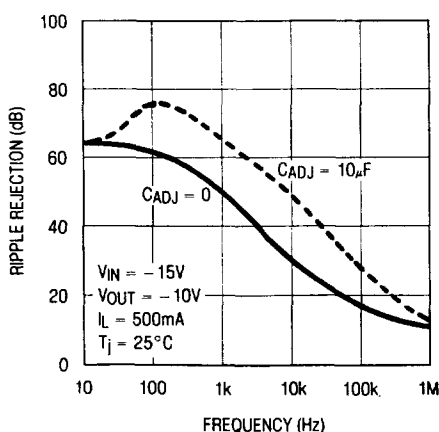

Ripple Rejection

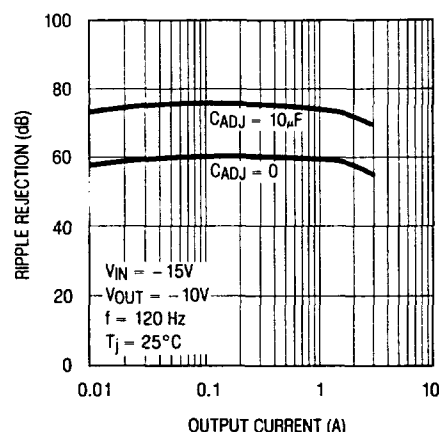

Output Impedance

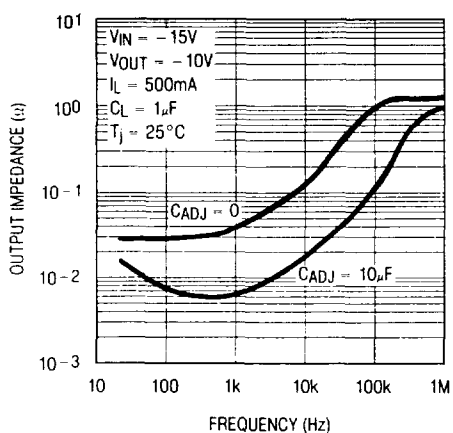

Line Transient Response

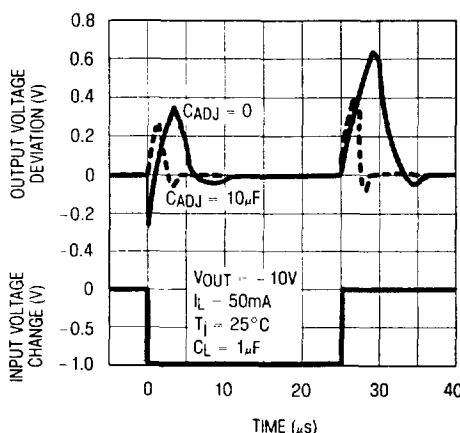

Load Transient Response

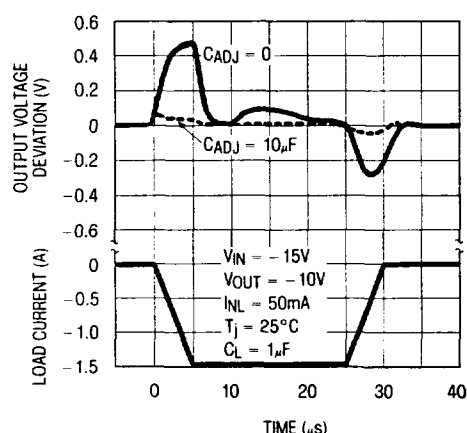

TYPICAL PERFORMANCE CHARACTERISTICS

Load Regulation*

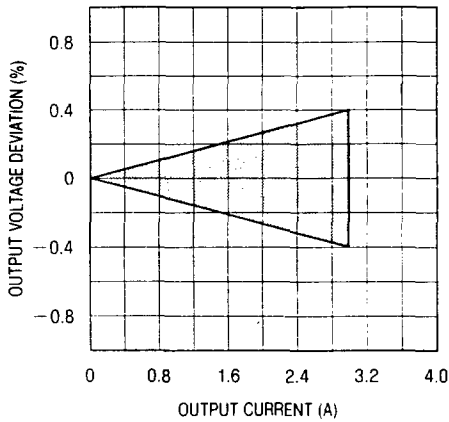

* The LT1033 has load regulation compensation which makes the typical unit read close to zero. This band represents the typical production spread.

Guaranteed Minimum Output Current

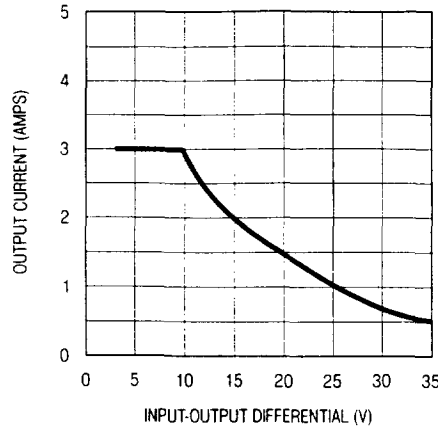

Adjustment Current

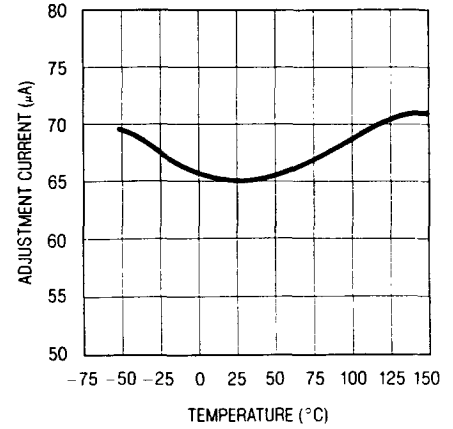

APPLICATION INFORMATION

Output Voltage: The output voltage is determined by two external resistors, R_1 & R_2 (see Figure 1). The exact formula for the output voltage is:

$$V_{OUT} = V_{REF} \left(1 + \frac{R_2}{R_1} \right) + I_{ADJ} (R_2)$$

Where: V_{REF} = Reference Voltage, I_{ADJ} = Adjustment Pin Current. In most applications, the second term is small enough to be ignored, typically about 0.5% of V_{OUT} . In more critical applications, the exact formula should be used, with I_{ADJ} equal to $65\mu A$. Solving for R_2 yields:

$$R_2 = \frac{V_{OUT} - V_{REF}}{\frac{V_{REF}}{R_1} - I_{ADJ}}$$

Smaller values of R_1 and R_2 will reduce the influence of I_{ADJ} on the output voltage, but the no-load current drain on the regulator will be increased. Typical values for R_1 are between 100Ω and 300Ω , giving $12.5mA$ and $4.2mA$ no-load current respectively. There is an additional consideration in selecting R_1 , the minimum load current specification of the regulator. The operating current of the LT1033 flows from input to output. If this current is not absorbed by the load, the output of the regulator will rise above the regulated value. The current drawn by R_1 and R_2 is normally high enough to

absorb the current, but care must be taken in no-load situations where R_1 and R_2 have high values. The maximum value for the operating current, which must be absorbed, is $5mA$ for the LT1033. If input-output voltage differential is less than $10V$, the operating current that must be absorbed drops to $3mA$.

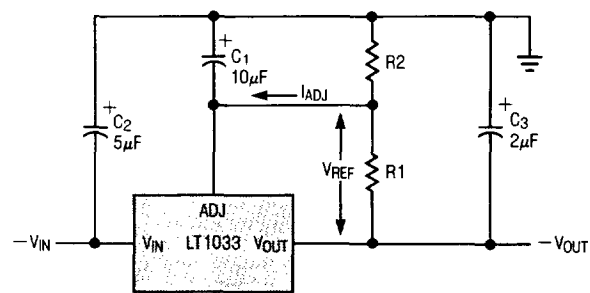

Figure 1

EXAMPLE:

1. A precision 10V regulator to supply up to 3 Amp load current.
 - a. Select $R_1 = 100\Omega$ to minimize effect of I_{ADJ}
 - b. Calculate $R_2 = \frac{V_{OUT} - V_{REF}}{\frac{V_{REF}}{R_1} - I_{ADJ}} = \frac{10V - 1.25V}{\frac{1.25V}{100\Omega} - 65\mu A} = 704\Omega$

APPLICATION INFORMATION

Capacitors and Protection Diodes: An output capacitor, C3, is required to provide proper frequency compensation of the regulator feedback loop. A 2 μ F or larger solid tantalum capacitor is generally sufficient for this purpose if the 1MHz impedance of the capacitor is 1 Ω or less. High Q capacitors, such as Mylar, are not recommended because they tend to reduce the phase margin at light load currents. Aluminum electrolytic capacitors may also be used, but the minimum value should be 25 μ F to ensure a low impedance at 1MHz. The output capacitor should be located within a few inches of the regulator to keep lead impedance to a minimum. The following caution should be noted: if the output voltage is greater than 6V and an output capacitor greater than 20 μ F has been used, it is possible to damage the regulator if the input voltage becomes shorted, due to the output capacitor discharging into the regulator. This can be prevented by using diode D1 (see Figure 2) between the input and the output.

The input capacitor, C2, is only required if the regulator is more than 4 inches from the raw supply filter capacitor.

Bypassing the Adjustment Pin: The adjustment pin of the LT1033 may be bypassed with a capacitor to ground, C1, to reduce output ripple, noise, and impedance. These parameters scale directly with output voltage if the adjustment pin is not bypassed. A bypass capacitor reduces ripple, noise, and impedance to that of a 1.25V regulator. In a 15V regulator for example, these parameters are improved by $15V/1.25V = 12$ to 1. This improvement holds only for those frequencies where the impedance of the bypass capacitor is less than R₁. Ten microfarads is generally sufficient for 60Hz power line applications where the ripple frequency is 120Hz, since $X_C = 130\Omega$. The capacitor should have a voltage rating at least as high as the output voltage of the regulator. Values larger than 10 μ F may be used, but if the output is larger than 25V, a diode, D2, should be added between the output and adjustment pins (see Figure 2).

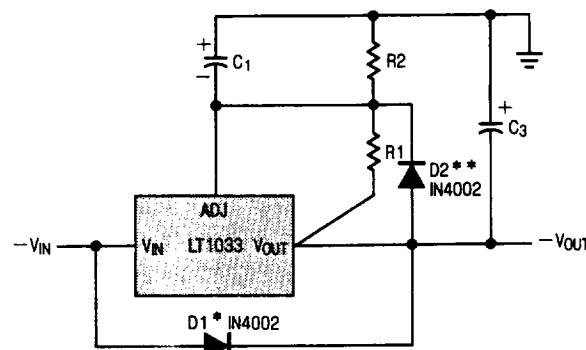

* D1 protects the regulator from input shorts to ground. It is required only when C3 is larger than 20 μ F and V_{OUT} is larger than 6V. ** D2 protects the adjust pin of the regulator from output shorts if C2 is larger than 10 μ F and V_{OUT} is larger than -25V.

Figure 2

Proper Connection of Divider Resistors: The LT1033 has a load regulation specification of 0.8% and is measured at a point 1/8" from the bottom of the package. To prevent degradation of load regulation, the resistors which set output voltage, R₁ and R₂, must be connected as shown in Figure 3. Note that the positive side of the load has a true force and sense (Kelvin) connection, but the negative side of the load does not.

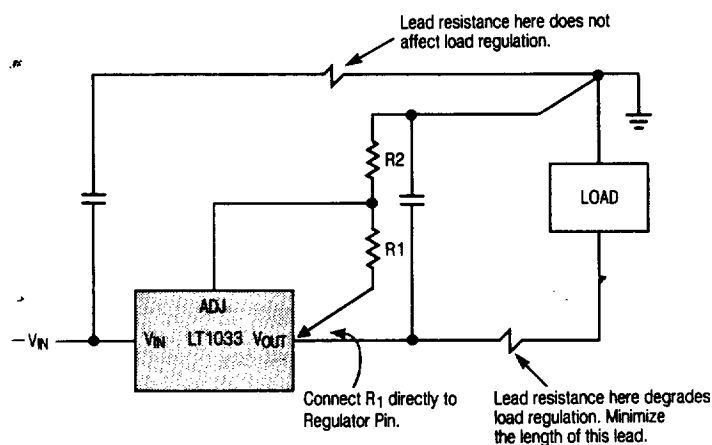

Figure 3

R₁ should be connected *directly* to the output lead of the regulator, as close as possible to the specified point 1/8" from the case. R₂ should be connected to the positive side of the load separately from the positive (ground) connection to the raw supply. With this arrangement, load regulation is degraded only by the resistance between the regulator output pin and the load. If R₁ is connected to the load, regulation will be degraded.

LT1033

TYPICAL APPLICATIONS

The output stability, load regulation, line regulation, thermal regulation, temperature drift, long term drift, and noise, can be improved by a factor of 6.6 over the standard regulator configuration. This assumes a zener whose drift and noise is considerably better than the regulator itself. The LM329B has 20PPM/°C maximum drift and about 10 times lower noise than the regulator.

In the application shown below, regulators #2 to "N" will track regulator #1 to within ±24mV initially, and to ±60mV over all load, line, and temperature conditions. If any regulator output is shorted to ground, all other outputs will drop to ≈ -2V. Load regulation of regulators 2 to "N" will be improved by $V_{OUT}/1.25V$ compared to a standard regulator, so regulator #1 should be the one which has the lowest load current.

High Stability Regulator

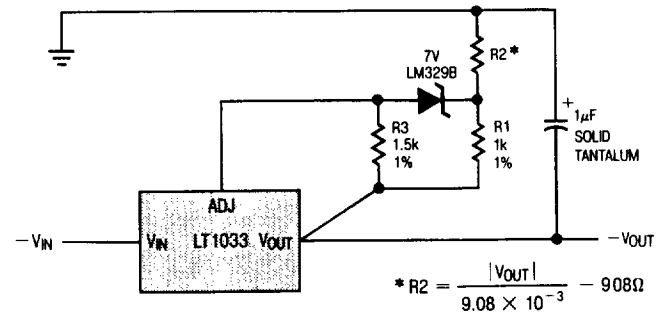

Dual Tracking 3A Supply ± 1.25V to ± 20V

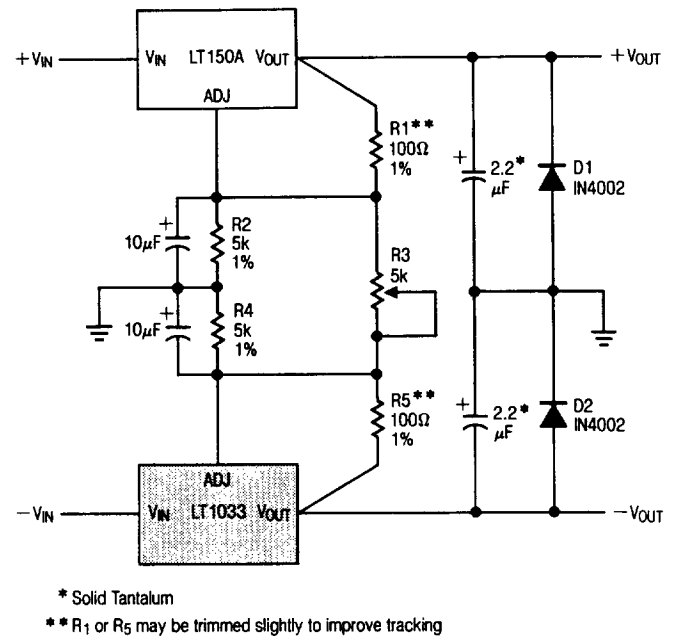

Multiple Tracking Regulators

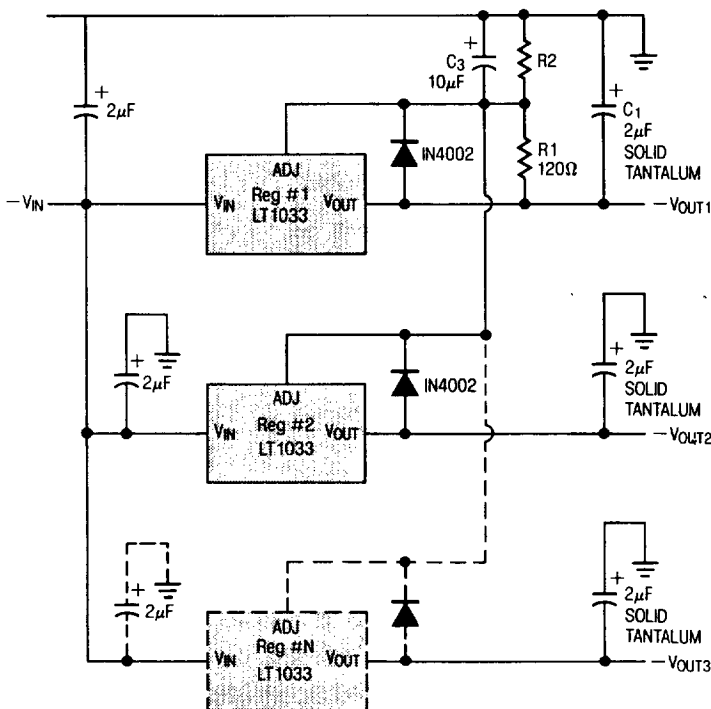

Current Regulator

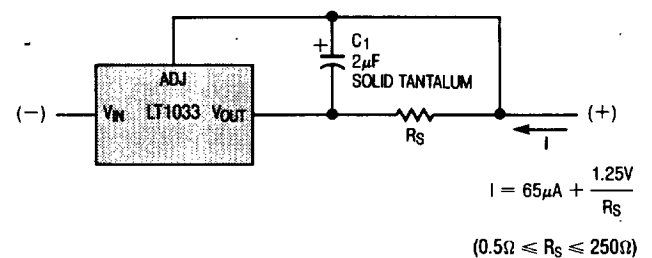

LT1033

PACKAGE DESCRIPTION

K Package TO-3 STEEL Metal Can

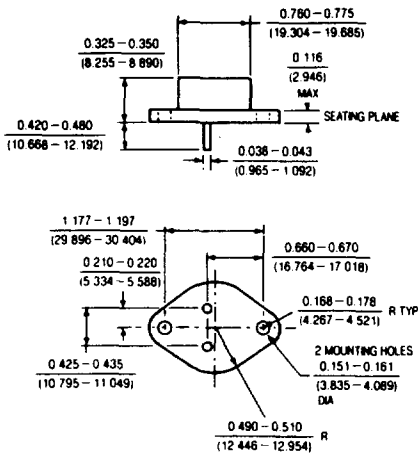

	T _J MAX	θ _{JC}
LT1033M	150°C	2°C/W
LT1033C	125°C	2°C/W

T Package TO-220 Plastic

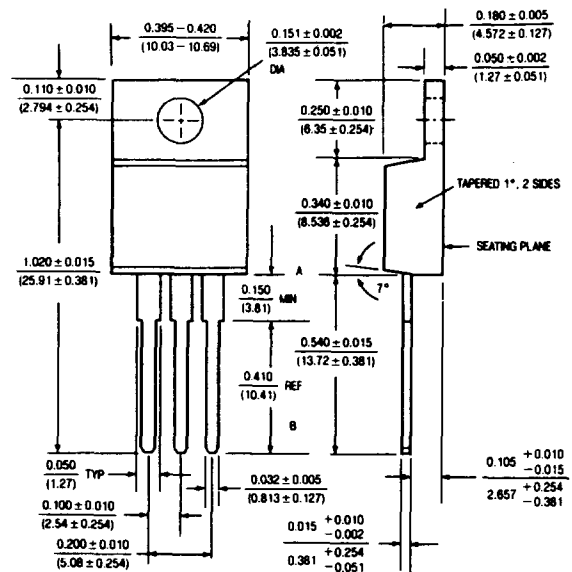

	T _J MAX	θ _{JC}
LT1033C	125°C	4°C/W