



January 2006

FGPF7N60LSD

600V, 7A Low Saturation IGBT CO-PAK

Features

- Low saturation voltage : $V_{CE(sat)} = 1.4\text{ V @ } I_C = 7\text{ A}$
- High input impedance
- CO-PAK, IGBT with FRD : $t_{rr} = 50\text{ ns (typ.)}$

Description

Fairchild's Insulated Gate Bipolar Transistors (IGBTs) provides very low conduction and switching losses. The device is designed for Lamp applications where very low On-Voltage Drop is a required feature.

Applications

Lamp applications (Hallogen Dimmer)

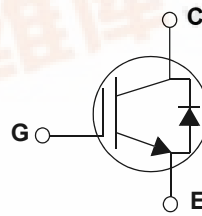
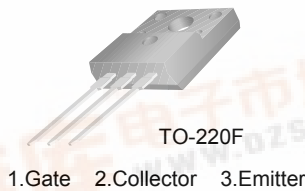

Absolute Maximum Ratings

Symbol	Description	FGPF7N60LSD	Units
V_{CES}	Collector-Emitter Voltage	600	V
V_{GES}	Gate-Emitter Voltage	± 20	V
I_C	Collector Current	@ $T_C = 25^\circ\text{C}$	14
	Collector Current	@ $T_C = 100^\circ\text{C}$	7
$I_{CM(1)}$	Pulsed Collector Current	21	A
I_F	Diode Continuous Forward Current	@ $T_C = 100^\circ\text{C}$	12
I_{FM}	Diode Maximum Forward Current	60	A
P_D	Maximum Power Dissipation	@ $T_C = 25^\circ\text{C}$	45
	Maximum Power Dissipation	@ $T_C = 100^\circ\text{C}$	18
T_J	Operating Junction Temperature	-55 to +150	$^\circ\text{C}$
T_{stg}	Storage Temperature Range	-55 to +150	$^\circ\text{C}$
T_L	Maximum Lead Temp. for Soldering Purposes, 1/8" from Case for 5 Seconds	300	$^\circ\text{C}$

Notes :

(1) Repetitive rating : Pulse width limited by max. junction temperature

Thermal Characteristics

Symbol	Parameter	Typ.	Max.	Units
$R_{\theta JC}$ (IGBT)	Thermal Resistance, Junction-to-Case	--	2.8	$^\circ\text{C/W}$
$R_{\theta JC}$ (DIODE)	Thermal Resistance, Junction-to-Case	--	4.5	$^\circ\text{C/W}$
$R_{\theta JA}$	Thermal Resistance, Junction-to-Ambient (PCB Mount) (2)	--	62.5	$^\circ\text{C/W}$

Notes :

(2) Mounted on 1" square PCB (FR4 or G-10 Material)

FGPF7N60LSD 600V, 7A Low Saturation IGBT CO-PAK



Package Marking and Ordering Information

Device Marking	Device	Package	Packaging Type	Qty per Tube	Max Qty per Box
FGPF7N60LSD	FGPF7N60LSDTU	TO-220F	Rail /Tube	50ea	1,000ea

Electrical Characteristics of the IGBT T_C = 25°C unless otherwise noted

Symbol	Parameter	Test Conditions	Min.	Typ.	Max.	Units
Off Characteristics						
BV _{CES}	Collector-Emitter Breakdown Voltage	V _{GE} = 0V, I _C = 250uA	600	--	--	V
ΔBV _{CES} /ΔT _J	Temperature Coefficient of Breakdown] Voltage	V _{GE} = 0V, I _C = 1mA	--	0.6	--	V/°C
I _{CES}	Collector Cut-Off Current	V _{CE} = V _{CES} , V _{GE} = 0V	--	--	250	uA
I _{GES}	G-E Leakage Current	V _{GE} = V _{GES} , V _{CE} = 0V	--	--	± 100	nA
On Characteristics						
V _{GE(th)}	G-E Threshold Voltage	I _C = 7mA, V _{CE} = V _{GE}	5.0	6.5	8.0	V
V _{CE(sat)}	Collector to Emitter Saturation Voltage	I _C = 7A, V _{GE} = 15V	--	1.4	2.0	V
		I _C = 7A, V _{GE} = 15V, T _C = 125°C	--	1.47	--	V
		I _C = 14 A, V _{GE} = 15V	--	1.85	--	V
Dynamic Characteristics						
C _{ies}	Input Capacitance	V _{CE} = 30V, V _{GE} = 0V, f = 1MHz	--	510	--	pF
C _{oes}	Output Capacitance		--	55	--	pF
C _{res}	Reverse Transfer Capacitance		--	15	--	pF
Switching Characteristics						
t _{d(on)}	Turn-On Delay Time	V _{CC} = 300 V, I _C = 7A, R _G = 470Ω, V _{GE} = 15V, Inductive Load, T _C = 25°C	--	120	--	ns
t _r	Rise Time		--	44	--	ns
t _{d(off)}	Turn-Off Delay Time		--	410	535	ns
t _f	Fall Time		--	2320	3480	ns
E _{on}	Turn-On Switching Loss		--	0.27	--	uJ
E _{off}	Turn-Off Switching Loss		--	3.8	--	mJ
E _{ts}	Total Switching Loss		--	4.07	6.1	mJ
t _{d(on)}	Turn-On Delay Time	V _{CC} = 300 V, I _C = 7 A, R _G = 470Ω, V _{GE} = 15V, Inductive Load, T _C = 125°C	--	105	--	ns
t _r	Rise Time		--	50	--	ns
t _{d(off)}	Turn-Off Delay Time		--	420	--	ns
t _f	Fall Time		--	3745	--	ns
E _{on}	Turn-On Switching Loss		--	0.22	--	uJ
E _{off}	Turn-Off Switching Loss		--	5.94	--	mJ
E _{ts}	Total Switching Loss		--	6.16	--	mJ
Q _g	Total Gate Charge	V _{CE} = 300 V, I _C = 7A, V _{GE} = 15V	--	24	36	nC
Q _{ge}	Gate-Emitter Charge		--	4	6	nC
Q _{gc}	Gate-Collector Charge		--	10	15	nC
L _e	Internal Emitter Inductance	Measured 5mm from PKG	--	7.5	--	nH

Electrical Characteristics of DIODE $T_C = 25^\circ\text{C}$ unless otherwise noted

Symbol	Parameter	Test Conditions	Min.	Typ.	Max.	Units	
V_{FM}	Diode Forward Voltage	$I_F = 7\text{A}$	$T_C = 25^\circ\text{C}$	--	1.65	2.1	V
			$T_C = 100^\circ\text{C}$	--	1.58	--	
t_{rr}	Diode Reverse Recovery Time	$I_F = 7\text{A}$ $di/dt = 200\text{ A}/\mu\text{s}$	$T_C = 25^\circ\text{C}$	--	50	65	ns
			$T_C = 100^\circ\text{C}$	--	58	--	
I_{rr}	Diode Peak Reverse Recovery Current		$T_C = 25^\circ\text{C}$	--	2.5	3.75	A
			$T_C = 100^\circ\text{C}$	--	3.3	--	
Q_{rr}	Diode Reverse Recovery Charge		$T_C = 25^\circ\text{C}$	--	62.5	122	nC
			$T_C = 100^\circ\text{C}$	--	95.7	--	

Typical Performance Characteristics

Figure 1. Typical Output Characteristics

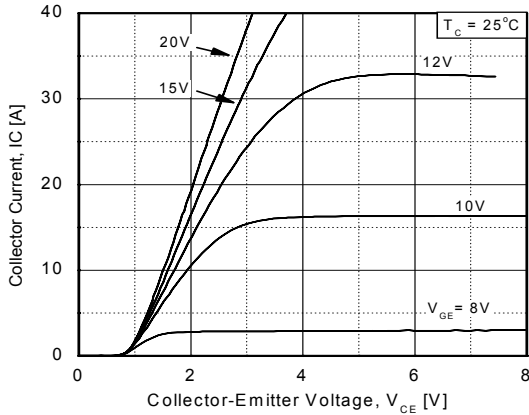

Figure 2. Typical Saturation Voltage Characteristics

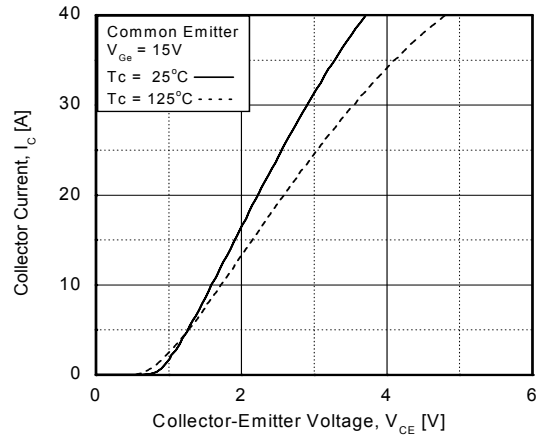

Figure 3. Typical Saturation Voltage Characteristics

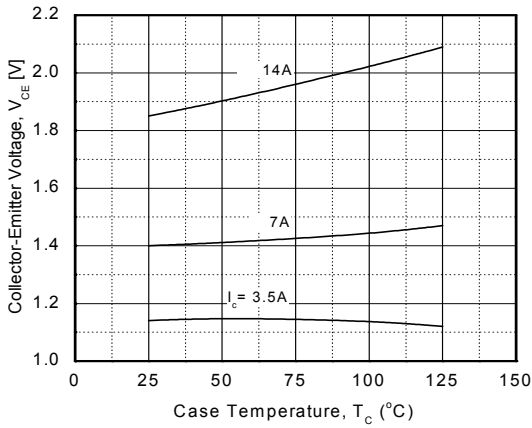

Figure 4. Load Current vs Frequency

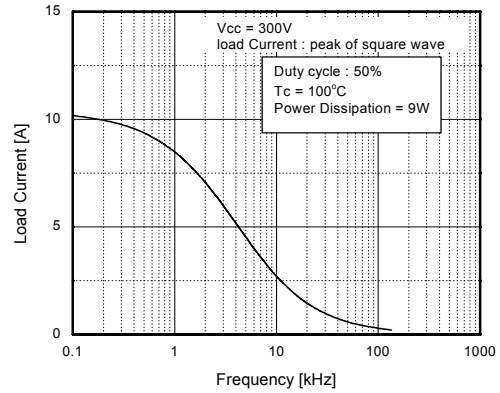

Figure 5. Saturation Voltage vs. V_{GE}

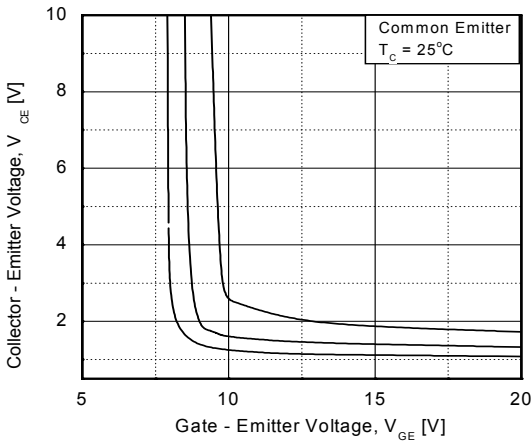
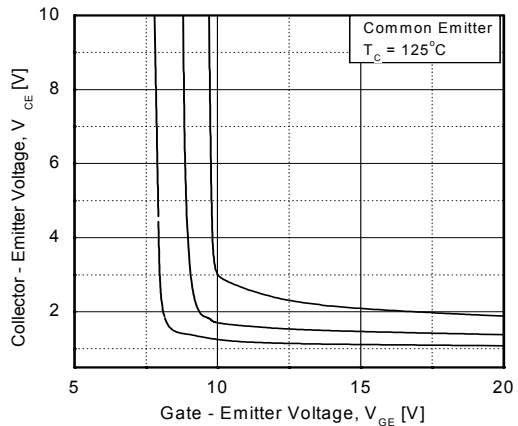

Figure 6. Saturation Voltage vs. V_{GE}



Typical Performance Characteristics (Continued)

Figure 7. Capacitance Characteristics

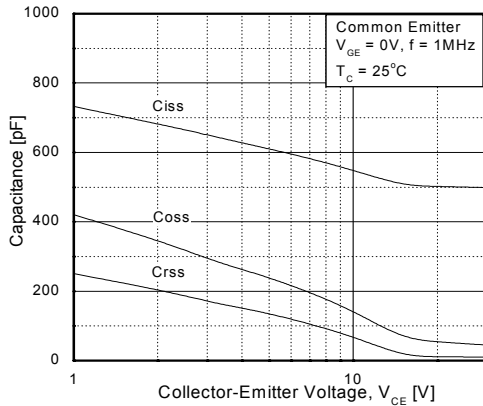

Figure 8. Turn-On Characteristics vs. Gate Resistance

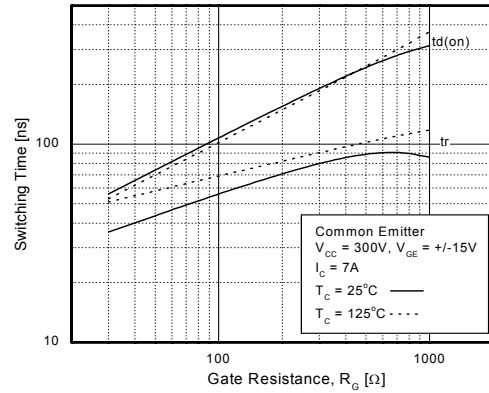

Figure 9. Turn-Off Characteristics vs. Gate Resistance

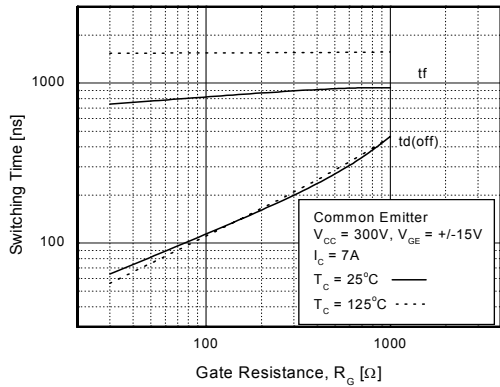

Figure 10. Switching Loss vs. Gate Resistance

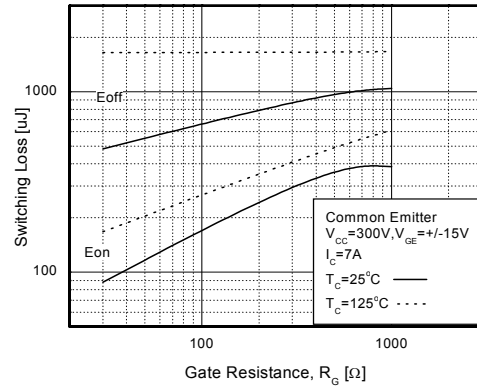

Figure 11. Turn-On Characteristics vs. Collector Current

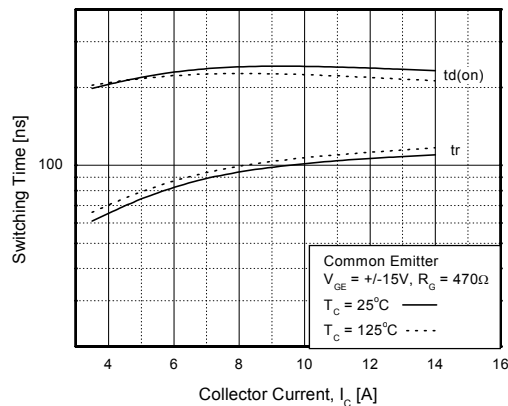
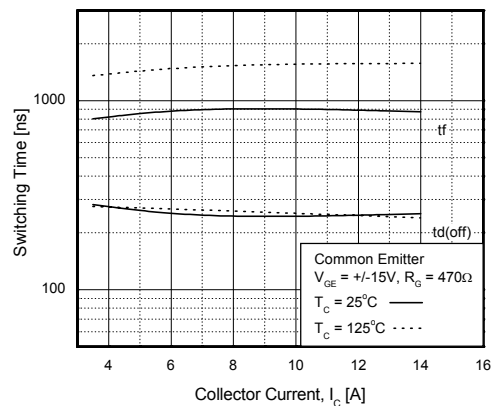

Figure 12. Turn-Off Characteristics vs. Collector Current



Typical Performance Characteristics (Continued)

Figure 13. Switching Loss vs. Collector Current

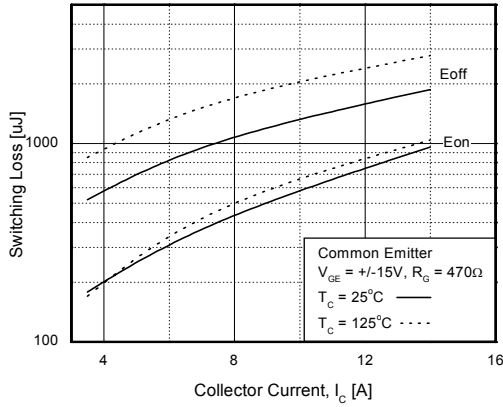

Figure 14. Gate Charge Characteristics

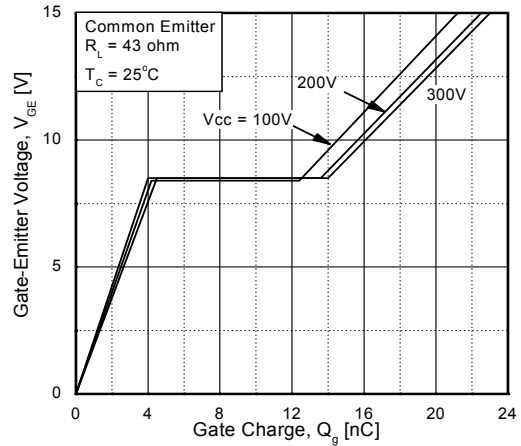

Figure 15. SOA Characteristics

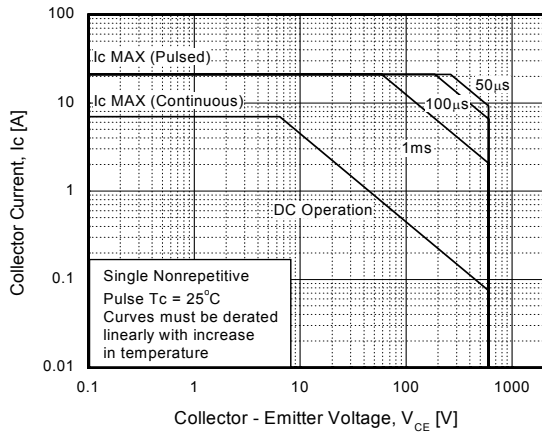
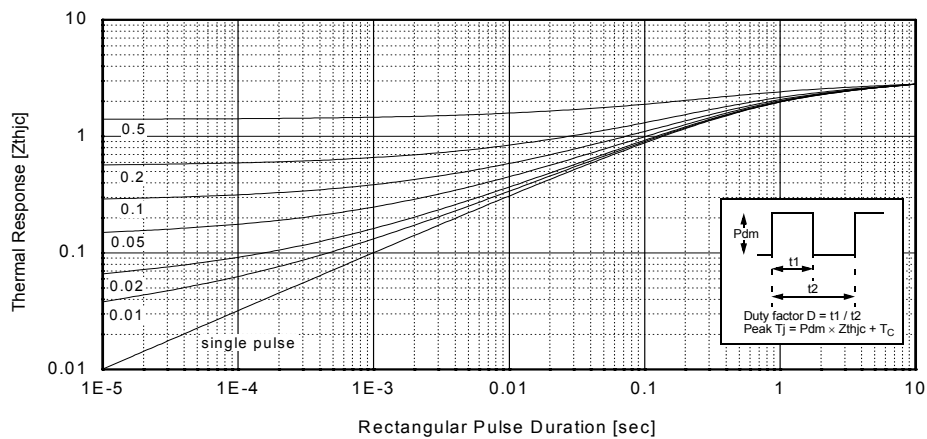

Figure 16. Transient Thermal Impedance of IGBT



Typical Performance Characteristics (Continued)

Figure 17. Forward Voltage Characteristics

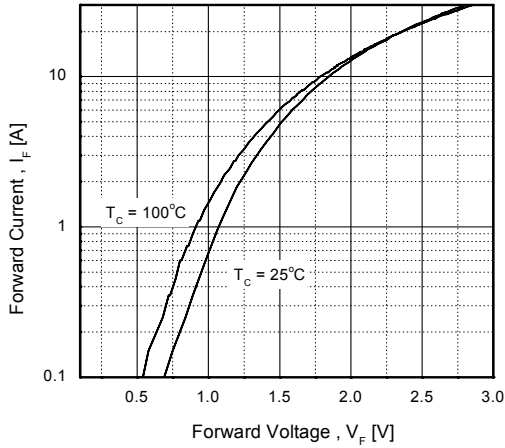

Figure 18. Reverse Recovery Current

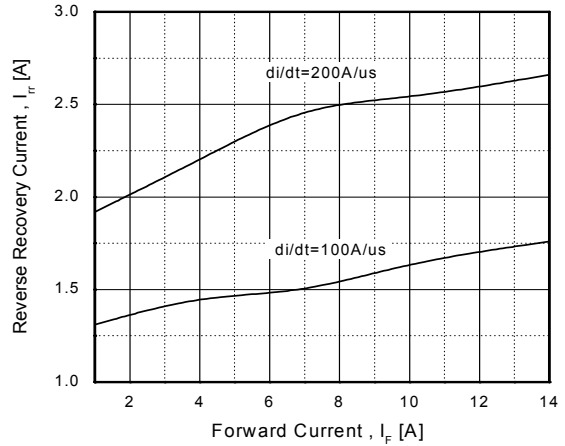

Figure 19. Stored Charge

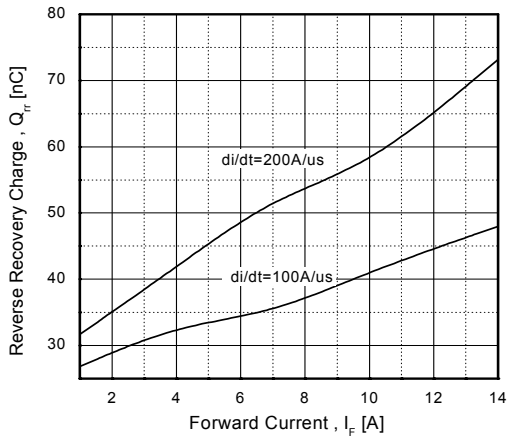
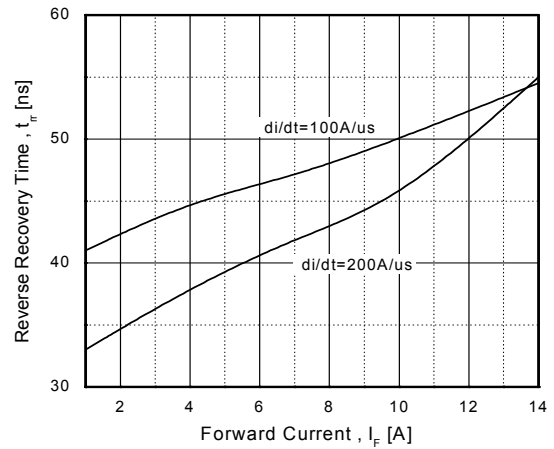
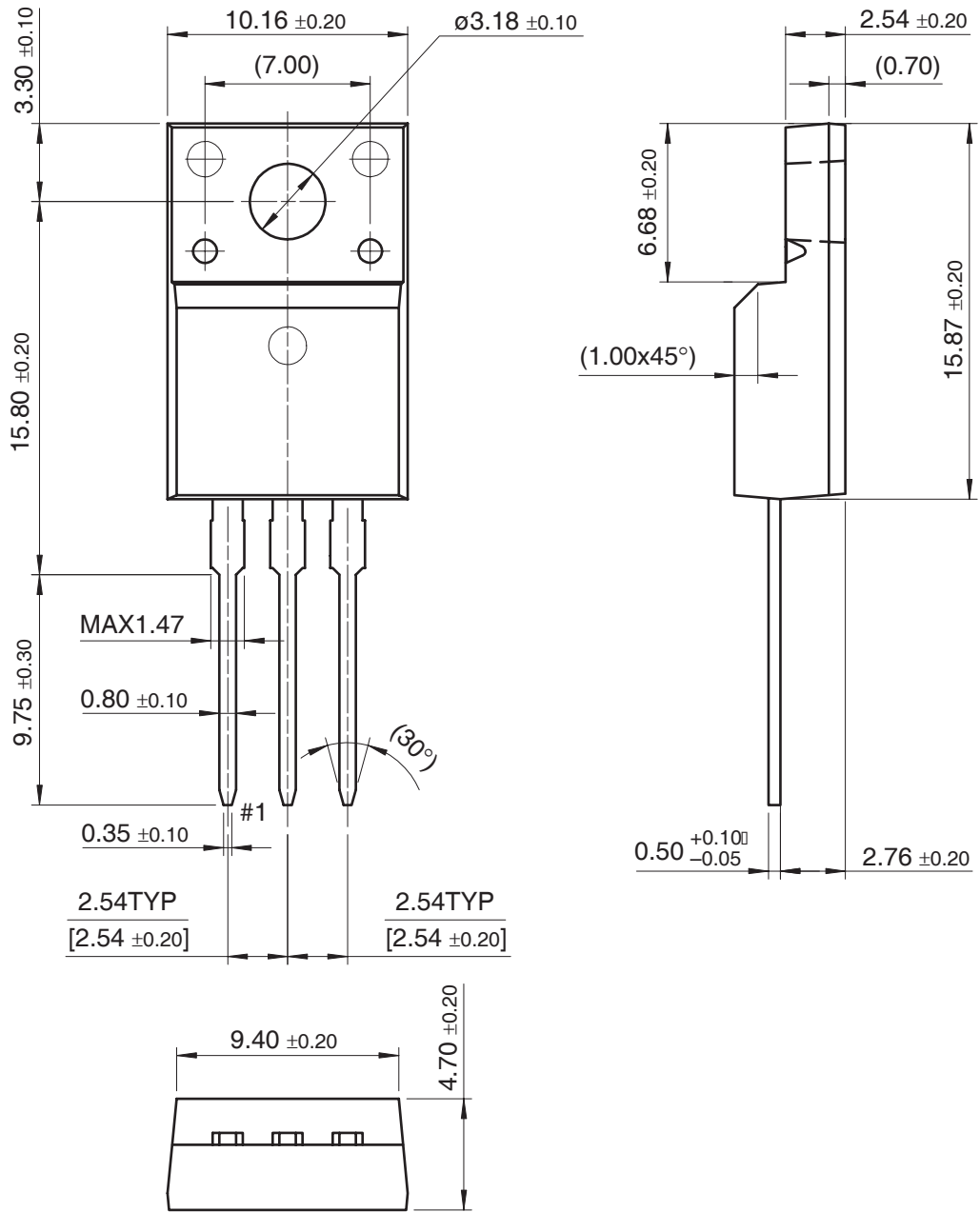

Figure 20. Reverse Recovery Time



Mechanical Dimensions

TO-220F



Dimensions in Millimeters

TRADEMARKS

The following are registered and unregistered trademarks Fairchild Semiconductor owns or is authorized to use and is not intended to be an exhaustive list of all such trademarks.

ACEx™	FAST®	ISOPLANAR™	PowerSaver™	SuperSOT™-6
ActiveArray™	FASTr™	LittleFET™	PowerTrench®	SuperSOT™-8
Bottomless™	FPST™	MICROCOUPLER™	QFET®	SyncFET™
Build it Now™	FRFET™	MicroFET™	QS™	TinyLogic®
CoolFET™	GlobalOptoisolator™	MicroPak™	QT Optoelectronics™	TINYOPTO™
CROSSVOL™	GTO™	MICROWIRE™	Quiet Series™	TruTranslation™
DOME™	HiSeC™	MSX™	RapidConfigure™	UHC™
EcoSPARK™	I ² C™	MSXPro™	RapidConnect™	UltraFET®
E ² CMOS™	i-Lo™	OCX™	µSerDes™	UniFET™
EnSigna™	ImpliedDisconnect™	OCXPro™	ScalarPump™	VCX™
FACT™	IntelliMAX™	OPTOLOGIC®	SILENT SWITCHER®	Wire™
FACT Quiet Series™		OPTOPLANAR™	SMART START™	
		PACMAN™	SPM™	
Across the board. Around the world.™		POP™	Stealth™	
The Power Franchise®		Power247™	SuperFET™	
Programmable Active Droop™		PowerEdge™	SuperSOT™-3	

DISCLAIMER

FAIRCHILD SEMICONDUCTOR RESERVES THE RIGHT TO MAKE CHANGES WITHOUT FURTHER NOTICE TO ANY PRODUCTS HEREIN TO IMPROVE RELIABILITY, FUNCTION OR DESIGN. FAIRCHILD DOES NOT ASSUME ANY LIABILITY ARISING OUT OF THE APPLICATION OR USE OF ANY PRODUCT OR CIRCUIT DESCRIBED HEREIN; NEITHER DOES IT CONVEY ANY LICENSE UNDER ITS PATENT RIGHTS, NOR THE RIGHTS OF OTHERS.

LIFE SUPPORT POLICY

FAIRCHILD'S PRODUCTS ARE NOT AUTHORIZED FOR USE AS CRITICAL COMPONENTS IN LIFE SUPPORT DEVICES OR SYSTEMS WITHOUT THE EXPRESS WRITTEN APPROVAL OF FAIRCHILD SEMICONDUCTOR CORPORATION.

As used herein:

- Life support devices or systems are devices or systems which, (a) are intended for surgical implant into the body, or (b) support or sustain life, or (c) whose failure to perform when properly used in accordance with instructions for use provided in the labeling, can be reasonably expected to result in significant injury to the user.
- A critical component is any component of a life support device or system whose failure to perform can be reasonably expected to cause the failure of the life support device or system, or to affect its safety or effectiveness.

PRODUCT STATUS DEFINITIONS

Definition of Terms

Datasheet Identification	Product Status	Definition
Advance Information	Formative or In Design	This datasheet contains the design specifications for product development. Specifications may change in any manner without notice.
Preliminary	First Production	This datasheet contains preliminary data, and supplementary data will be published at a later date. Fairchild Semiconductor reserves the right to make changes at any time without notice in order to improve design.
No Identification Needed	Full Production	This datasheet contains final specifications. Fairchild Semiconductor reserves the right to make changes at any time without notice in order to improve design.
Obsolete	Not In Production	This datasheet contains specifications on a product that has been discontinued by Fairchild semiconductor. The datasheet is printed for reference information only.

Rev. I17