

Overcurrent Protection **B597****
Leaded Disks, Uncoated, 380 V to 1000 V **B 750 ... B 774**

Applications

- Overcurrent and short-circuit protection

Features

- Lead-free terminals
- Manufacturer's logo, date code and type designation stamped on in black
- UL approval to UL 1434 with $V_{max} = 420$ V and $V_N = 380$ V (file number E69802), except B 758

Delivery mode

- Cardboard strips (standard)
- Cardboard tape reeled or in AMMO pack on request

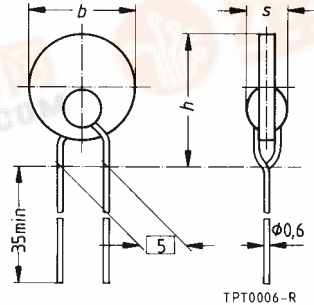

Dimensions (mm)

Type	b_{max}	h_{max}	s_{max}
B 75*	12,5	16,5	7,0
B 77*	8,5	12,1	7,0

General technical data

Switching cycles (typ.)	N	100	
Operating temperature range ($V = 0$) ($V = V_{max}$)	T_{op}	- 40/+ 125	°C
	T_{op}	0/+ 60	°C

Electrical specifications and ordering codes

Type	I_N mA	I_S mA	I_{Smax} ($V = V_{max}$) A	t_S (V_{max}, I_{Smax}) s	I_r (typ.) ($V = V_{max}$) mA	R_N Ω	R_{min} Ω	Ordering code
------	-------------	-------------	--------------------------------------	---------------------------------------	---	-------------------	-----------------------	---------------

$V_{max} = 420$ V, $V_N = 380$ V, $T_{Ref} = 120$ °C (typ.), $\Delta R_N = \pm 25$ %

B 750	123	245	2,0	< 6	4,0	25	13	B59750B0120A070
B 751	87	173	2,0	< 4	3,5	50	26	B59751B0120A070
B 752	69	137	2,0	< 4	3,5	80	42	B59752B0120A070
B 770	64	127	1,4	< 4	3,5	70	45	B59770B0120A070
B 753	56	112	2,0	< 3	3,0	120	63	B59753B0120A070
B 754	50	100	2,0	< 3	3,0	150	68	B59754B0120A070
B 771	49	97	1,4	< 3	2,5	120	76	B59771B0120A070
B 772	43	86	1,4	< 3	2,5	150	96	B59772B0120A070

$V_{max} = 550$ V, $V_N = 500$ V, $T_{Ref} = 115$ °C (typ.), $\Delta R_N = \pm 25$ %

B 755	28	55	1,4	< 3	2,0	500	230	B59755B0115A070
-------	----	----	-----	-----	-----	-----	-----	-----------------

$V_{max} = 550$ V, $V_N = 500$ V, $T_{Ref} = 120$ °C (typ.), $\Delta R_N = \pm 25$ %

B 773	24	48	1,0	< 3	2,0	500	320	B59773B0120A070
-------	----	----	-----	-----	-----	-----	-----	-----------------

$V_{max} = 550$ V, $V_N = 500$ V, $T_{Ref} = 115$ °C (typ.), $\Delta R_N = \pm 25$ %

B 774	16	32	1,0	< 2	1,5	1100	700	B59774B0115A070
-------	----	----	-----	-----	-----	------	-----	-----------------

$V_{max} = 1000$ V, $V_N = 1000$ V, $T_{Ref} = 110$ °C (typ.), $\Delta R_N = \pm 33$ %

B 758	8	17	0,5	< 3	3,0	7500	3380	B59758B0110A070
-------	---	----	-----	-----	-----	------	------	-----------------

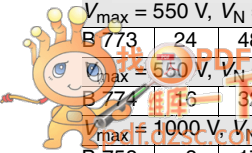



Overcurrent Protection

B597**

Leaded Disks, Uncoated, 380 V to 1000 V

B 750 ... B 774

Characteristics (typical)

PTC resistance R_{PTC} versus
PTC temperature T_{PTC}
(measured at low signal voltage)

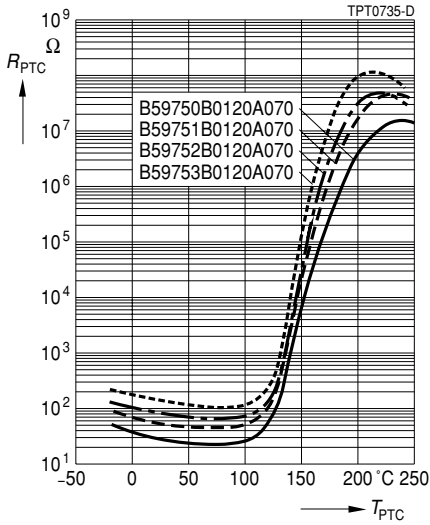

PTC current I_{PTC} versus PTC voltage V_{PTC}
(measured at 25 °C in still air)

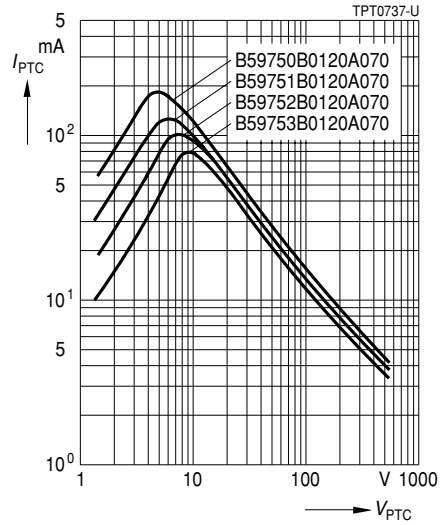

Switching time t_S versus switching current I_S
(measured at 25 °C in still air)

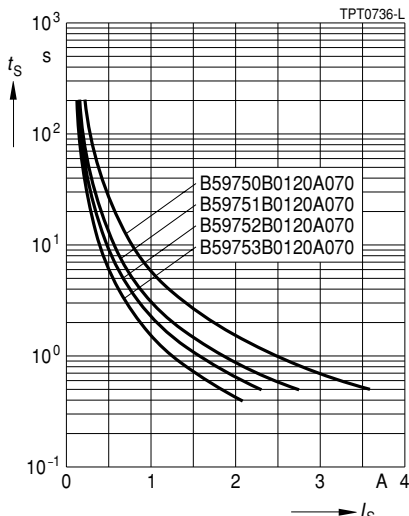

Rated current I_N versus ambient temperature T_A
(measured in still air)

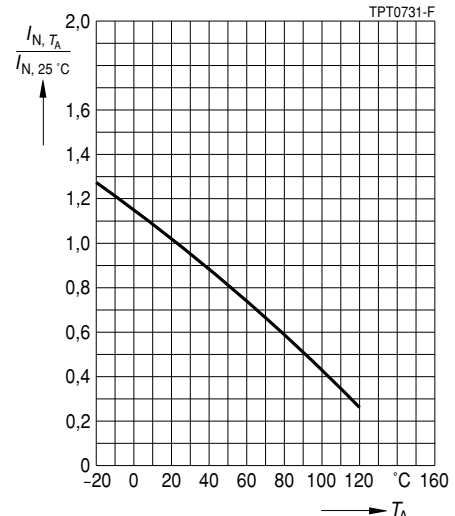



Characteristics (typical)

PTC resistance R_{PTC} versus
PTC temperature T_{PTC}
(measured at low signal voltage)

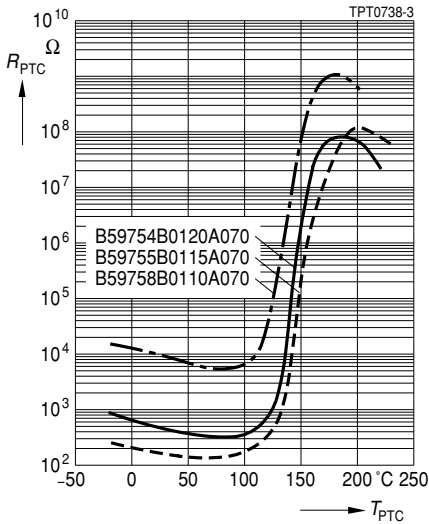

PTC current I_{PTC} versus PTC voltage V_{PTC}
(measured at 25 $^{\circ}C$ in still air)

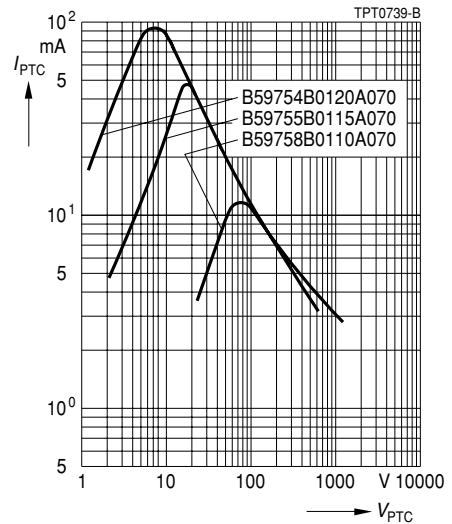

Switching time t_S versus switching current I_S
(measured at 25 $^{\circ}C$ in still air)

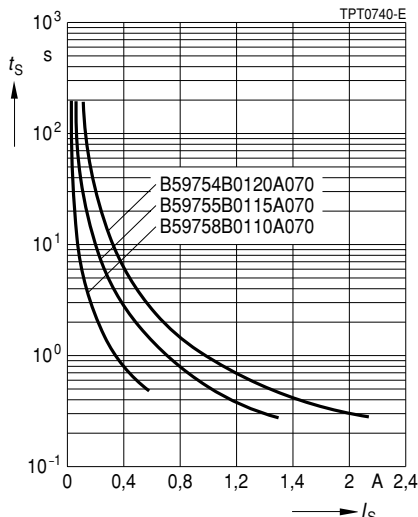

Rated current I_N versus ambient temperature T_A
(measured in still air)

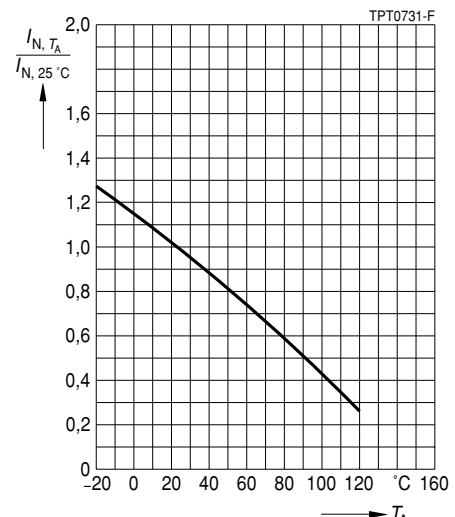



Characteristics (typical)

PTC resistance R_{PTC} versus
 PTC temperature T_{PTC}
 (measured at low signal voltage)

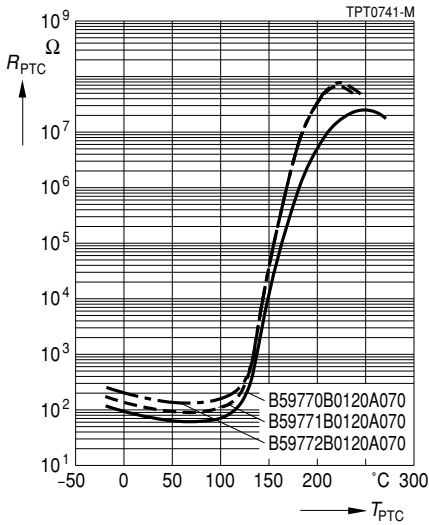

PTC current I_{PTC} versus PTC voltage V_{PTC}
 (measured at 25 °C in still air)

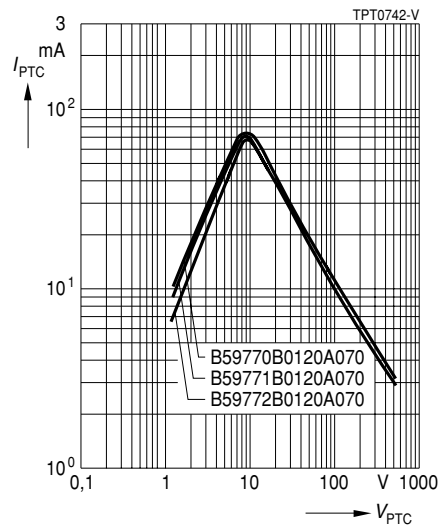

Switching time t_S versus switching current I_S
 (measured at 25 °C in still air)

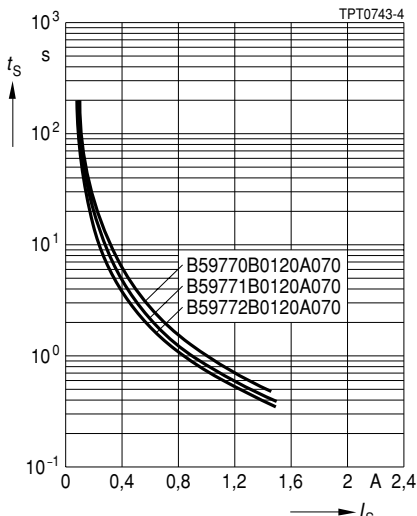

Rated current I_N versus ambient temperature T_A
 (measured in still air)

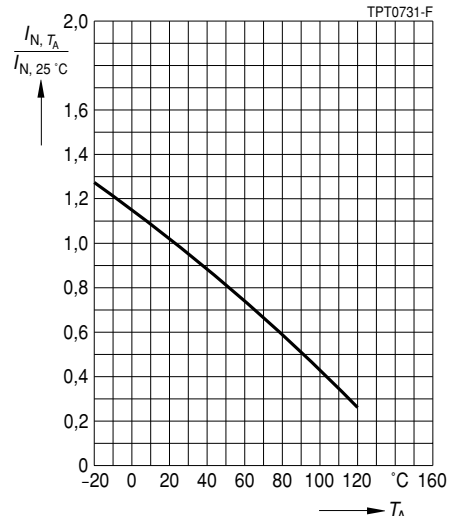



Characteristics (typical)

PTC resistance R_{PTC} versus
PTC temperature T_{PTC}
(measured at low signal voltage)

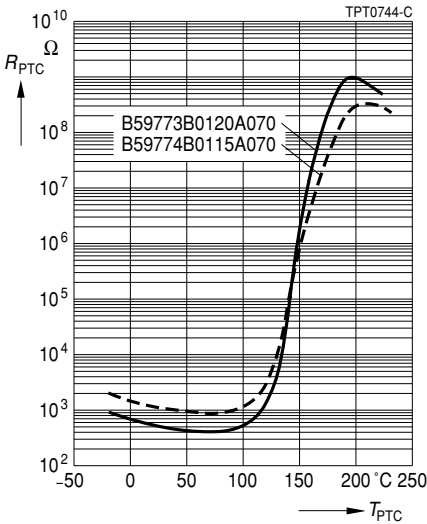

PTC current I_{PTC} versus PTC voltage V_{PTC}
(measured at 25 °C in still air)

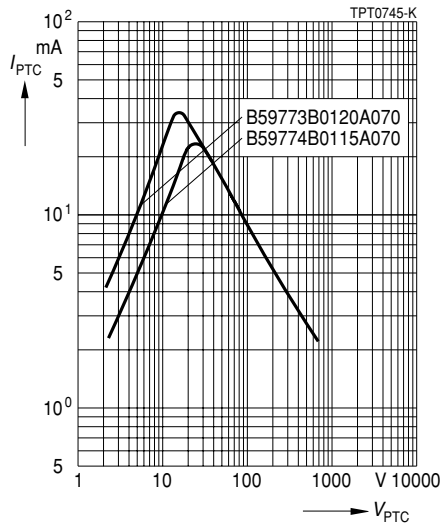

Switching time t_S versus switching current I_S
(measured at 25 °C in still air)

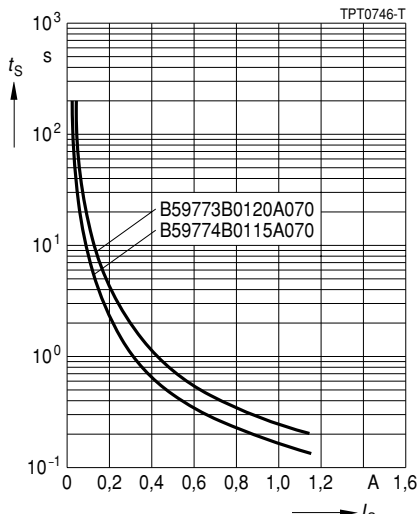

Rated current I_N versus ambient temperature T_A
(measured in still air)

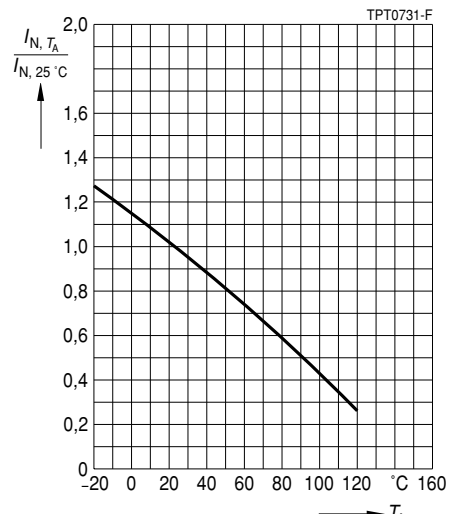

oder an unsere Vertriebsgesellschaften im Ausland. Bauelemente können aufgrund technischer E halten. Auskünfte darüber bitten wir unter Angabe des betreffenden Typs ebenfalls über die zuständ zuholen.

Published by EPCOS AG

Corporate Communications, P.O. Box 80 17 09, 81617 Munich, GERMANY

☎ ++49 89 636 09, FAX (089) 636-2 26 89

© EPCOS AG 2002. Reproduction, publication and dissemination of this brochure and the informa EPCOS' prior express consent is prohibited.

Purchase orders are subject to the General Conditions for the Supply of Products and Services of Industry recommended by the ZVEI (German Electrical and Electronic Manufacturers' Association).

This brochure replaces the previous edition.

For questions on technology, prices and delivery please contact the Sales Offices of EPCOS AG or tives.

Due to technical requirements components may contain dangerous substances. For information o also contact one of our Sales Offices.



中发网 WWW.ZFA.CN

全球最大的PDF中文下载站



中发网
www.zfa.cn

PDF 资料下载尽在中发网