



50 MHz to 400 MHz CASCADEABLE AMPLIFIER

FEATURES

- High Dynamic Range
 - $OIP_3 = 36 \text{ dBm}$
 - $NF < 4.5 \text{ dB}$
- Single Supply Voltage
- High Speed
 - $V_S = 3 \text{ V to } 5 \text{ V}$
 - $I_S = \text{Adjustable}$
- Input / Output Impedance
 - 50Ω

APPLICATIONS

- IF Amplifier
 - TDMA: GSM, IS-136, EDGE/UWE-136
 - CDMA: IS-95, UMTS, CDMA2000
 - Wireless Local Loop
 - Wireless LAN: IEEE802.11

DESCRIPTION

The THS9000 is a medium power, cascadeable, gain block optimized for high IF frequencies. The amplifier incorporates internal impedance matching to 50Ω . The part mounted on the standard EVM achieves greater than 15-dB input and output return loss from 50 MHz to 325 MHz with $V_S = 5 \text{ V}$, $R_{(BIAS)} = 237 \Omega$, $L_{(COL)} = 470 \text{ nH}$. Design requires only 2 dc-blocking capacitors, 1 power-supply bypass capacitor, 1 RF choke, and 1 bias resistor.

Functional Block Diagram

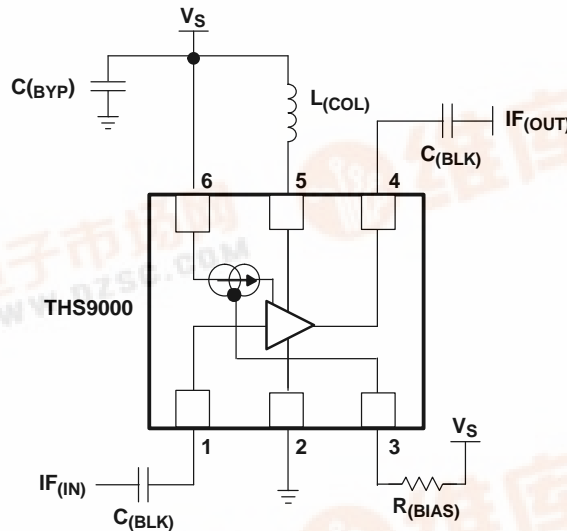



These devices have limited built-in ESD protection. The leads should be shorted together or the device placed in conductive foam during storage or handling to prevent electrostatic damage to the MOS gates.

AVAILABLE OPTIONS

PACKAGED DEVICE	PACKAGE TYPE	TRANSPORT MEDIA, QUANTITY
THS9000DRDT	2 x 2 QFN ⁽¹⁾	Tape and Reel, 250
THS9000DRDR		Tape and Reel, 3000

(1) The PowerPAD is electrically isolated from all other pins.

ABSOLUTE MAXIMUM RATINGS

over operating free-air temperature (unless otherwise noted)⁽¹⁾

	UNIT	
Supply voltage, GND to V _S	5.5 V	
Input voltage	GND to V _S	
Continuous power dissipation	See Dissipation Ratings Table	
Maximum junction temperature, T _J	150°C	
Maximum junction temperature, continuous operation, long term reliability, T _J ⁽²⁾	125°C	
Storage temperature, T _{stg}	-65°C to 150°C	
Lead temperature 1,6 mm (1/16 inch) from case for 10 seconds	300°C	
ESD Ratings:	HBM	2000
	CDM	1500
	MM	100

- (1) The absolute maximum ratings under any condition is limited by the constraints of the silicon process. Stresses above these ratings may cause permanent damage. Exposure to absolute maximum conditions for extended periods may degrade device reliability. These are stress ratings only, and functional operation of the device at these or any other conditions beyond those specified is not implied.
- (2) The maximum junction temperature for continuous operation is limited by package constraints. Operation above this temperature may result in reduced reliability and/or lifetime of the device.

DISSIPATION RATING TABLE

PACKAGE	Θ _{JA} (°C/W)	POWER RATING ⁽¹⁾	
		T _A ≤ 25°C	T _A = 85°C
DRD ⁽²⁾⁽³⁾	91	1.1 W	440 mW

- (1) Power rating is determined with a junction temperature of 125°C. Thermal management of the final PCB should strive to keep the junction temperature at or below 125°C for best performance.
- (2) This data was taken using the JEDEC standard High-K test PCB.
- (3) The THS9000 incorporates a PowerPAD™ on the underside of the chip. This acts as a heatsink and must be connected to a thermally dissipating plane for proper power dissipation. Failure to do so may result in exceeding the maximum junction temperature, which could permanently damage the device. See TI Technical Brief SLMA002 for more information about utilizing the PowerPAD™ thermally-enhanced package

RECOMMENDED OPERATING CONDITIONS

	MIN	NOM	MAX	UNIT
Supply voltage	2.7		5	V
Operating free-air temperature, T _A	-40		85	°C
Supply current		100		mA

ELECTRICAL CHARACTERISTICS

Typical Performance ($V_S = 5\text{ V}$, $R_{(\text{BIAS})} = 237\ \Omega$, $L_{(\text{COL})} = 470\text{ nH}$) (unless otherwise noted)

PARAMETER	TEST CONDITIONS	MIN	TYP	MAX	UNITS
Gain	$f = 50\text{ MHz}$		15.9		dB
	$f = 350\text{ MHz}$		15.6		
OIP ₃	$f = 50\text{ MHz}$		36		dBm
	$f = 350\text{ MHz}$		35		
1-dB compression	$f = 50\text{ MHz}$		20.8		dBm
	$f = 350\text{ MHz}$		20.6		
Input return loss	$f = 50\text{ MHz}$		15		dB
	$f = 350\text{ MHz}$		19.7		
Output return loss	$f = 50\text{ MHz}$		17.2		dB
	$f = 350\text{ MHz}$		15.1		
Reverse isolation	$f = 50\text{ MHz}$		21		dB
	$f = 350\text{ MHz}$		20		
Noise figure	$f = 50\text{ MHz}$		3.6		dB
	$f = 350\text{ MHz}$		4		

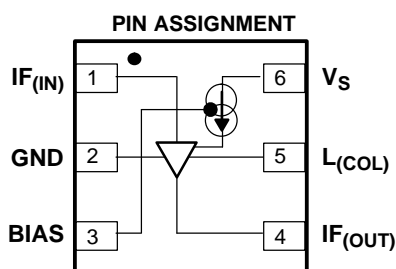

Terminal Functions

Pin Numbers	Name	Description
1	IF _(IN)	Signal input
2	GND	Negative power supply input
3	BIAS	Bias current adjustment input
4	IF _(OUT)	Signal output
5	L _(COL)	Output transistor load inductor
6	V _S	Positive power supply input

SIMPLIFIED SCHEMATIC

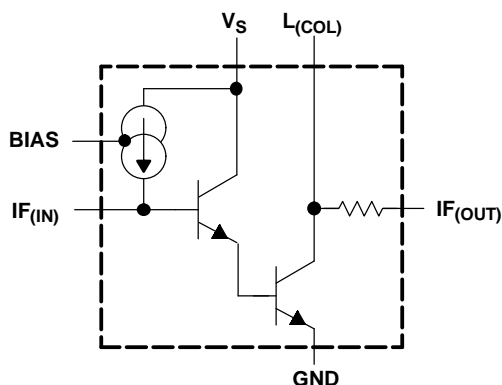

TYPICAL CHARACTERISTICS

TABLE OF GRAPHS

	FIGURE
S21 Frequency response	1
S22 Frequency response	2
S11 Frequency response	3
S12 Frequency response	4
S21 vs $R_{(BIAS)}$	5
Output power vs Input power	6
OIP ₂ vs Frequency	7
Noise figure vs Frequency	8
OIP ₃ vs Frequency	9
I_S Supply current vs $R_{(BIAS)}$	10
S21 Frequency response	11
S22 Frequency response	12
S11 Frequency response	13
S12 Frequency response	14
Noise figure vs Frequency	15
OIP ₂ vs Frequency	16
Output power vs Input power	17
OIP ₃ vs Frequency	18

S-Parameters of THS9000 as mounted on the EVM with $V_S = 5\text{ V}$, $R_{(BIAS)} = 237\ \Omega$, and $L_{(COL)} = 68\text{ nH}$ to 470 nH at room temperature.

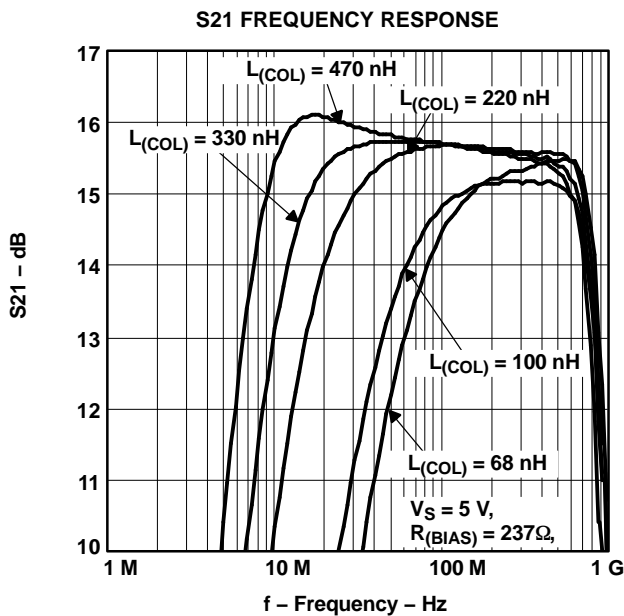

Figure 1.

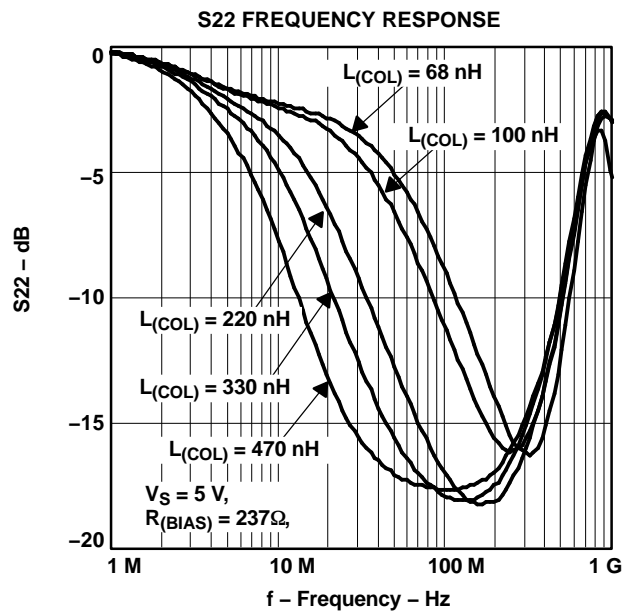

Figure 2.

TYPICAL CHARACTERISTICS (continued)

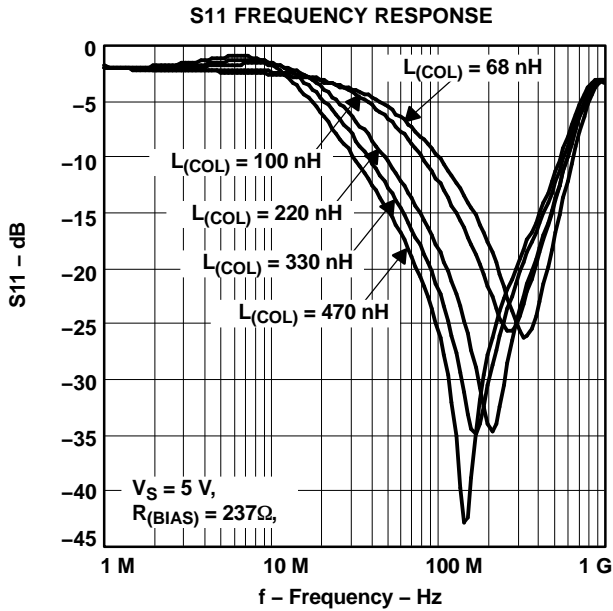

Figure 3.

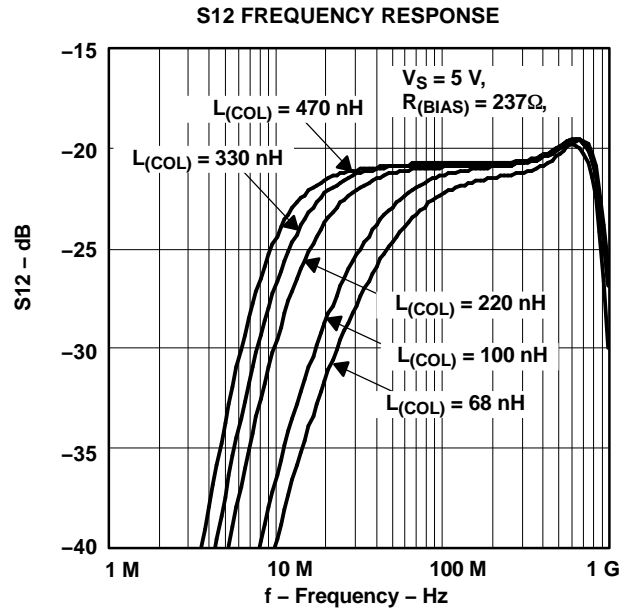

Figure 4.

S-Parameters of THS9000 as mounted on the EVM with $V_S = 3\text{ V}$ and 5 V , $R_{(BIAS)}$ = various, and $L_{(COL)} = 470\text{ nH}$ at room temp.

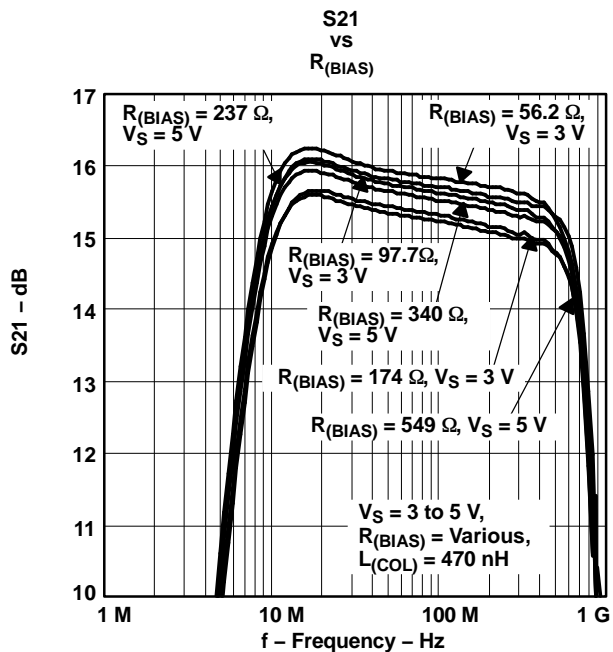

Figure 5.

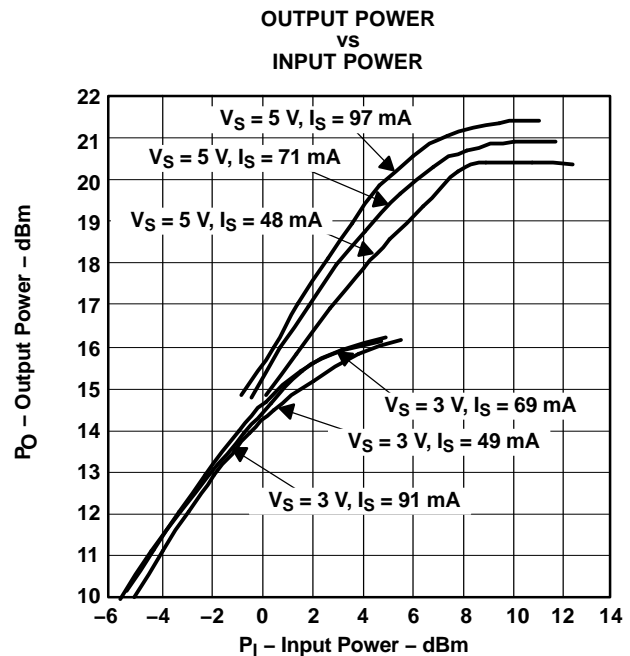

Figure 6.

TYPICAL CHARACTERISTICS (continued)

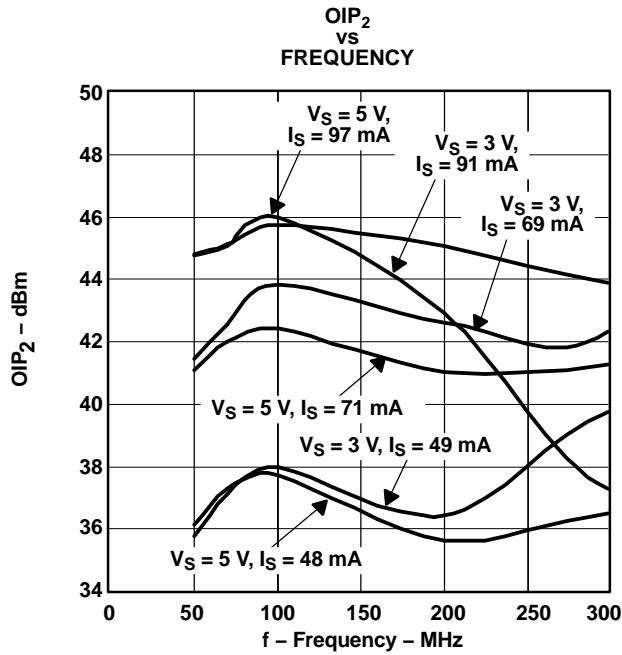

Figure 7.

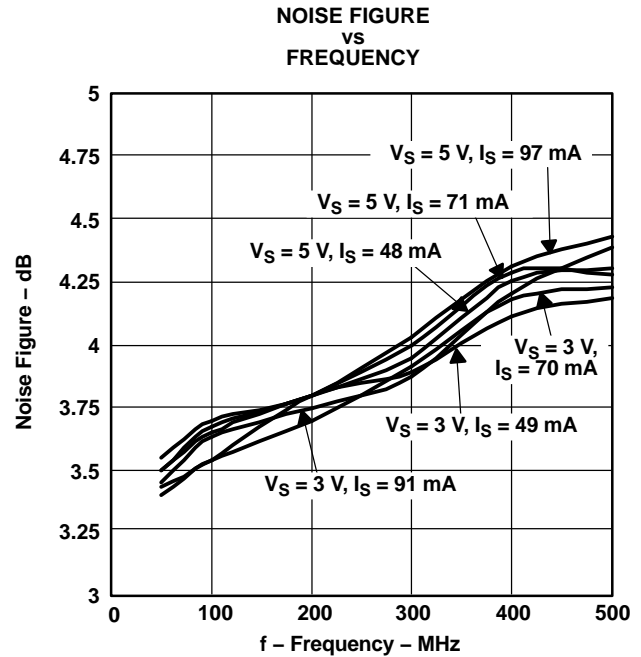

Figure 8.

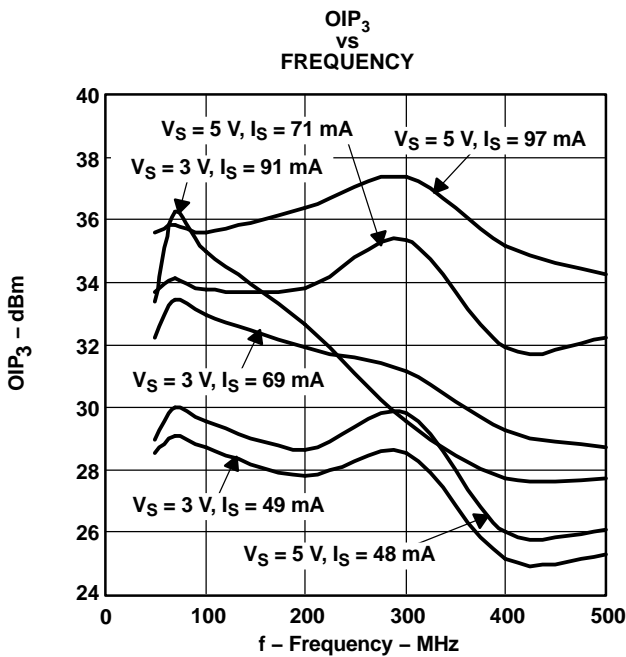

Figure 9.

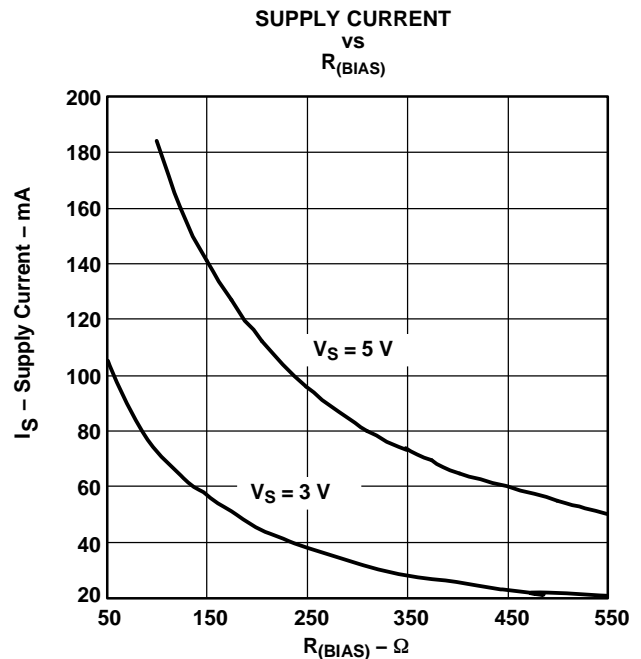

Figure 10.

TYPICAL CHARACTERISTICS (continued)

THS9000 as mounted on the EVM with $V_S = 5\text{ V}$, $R_{(BIAS)} = 237\ \Omega$, and $L_{(COL)} = 470\text{ nH}$ at 40°C , 25°C , and 85°C .

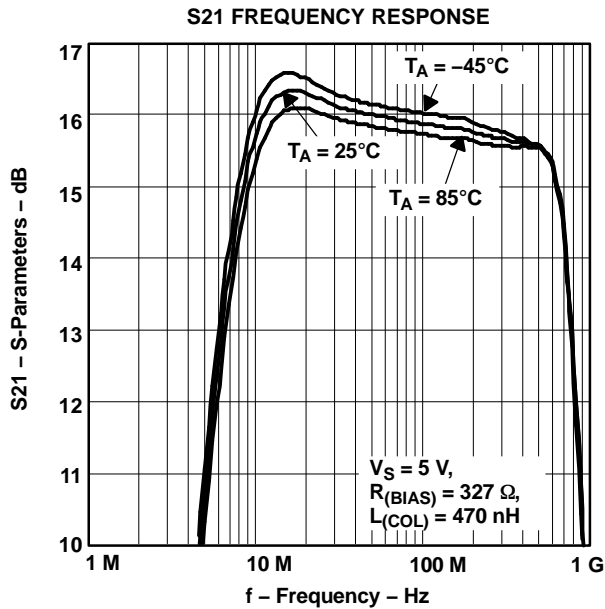

Figure 11.

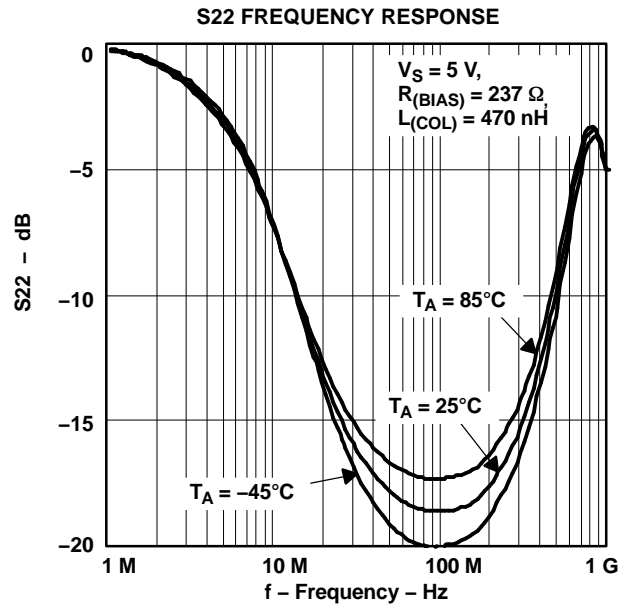

Figure 12.

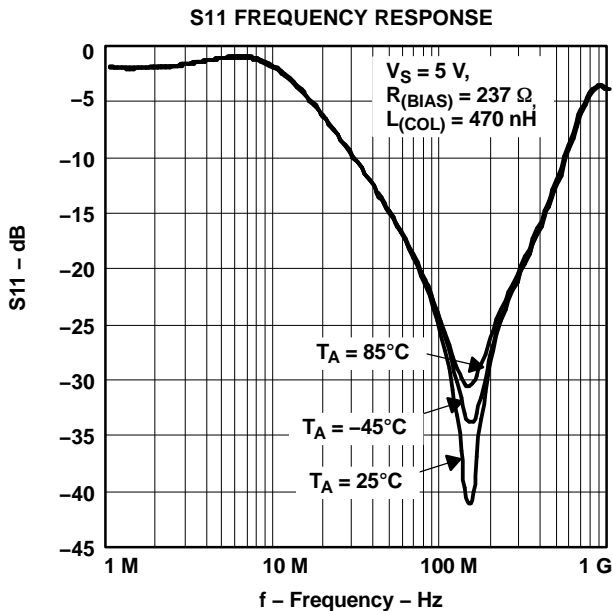

Figure 13.

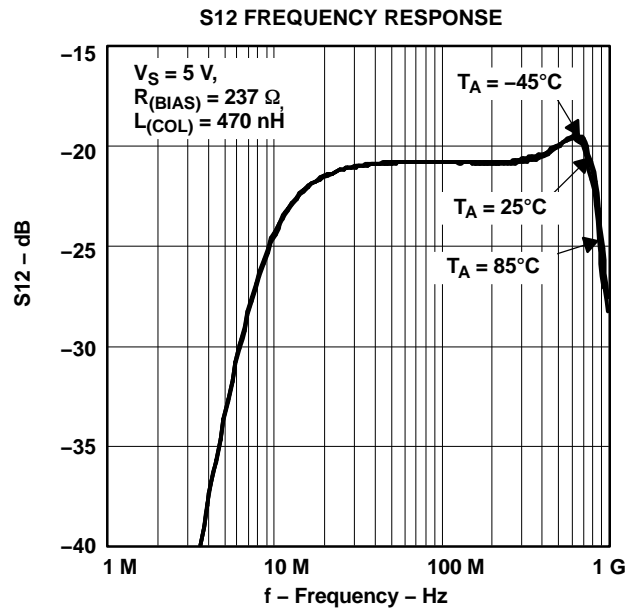

Figure 14.

TYPICAL CHARACTERISTICS (continued)

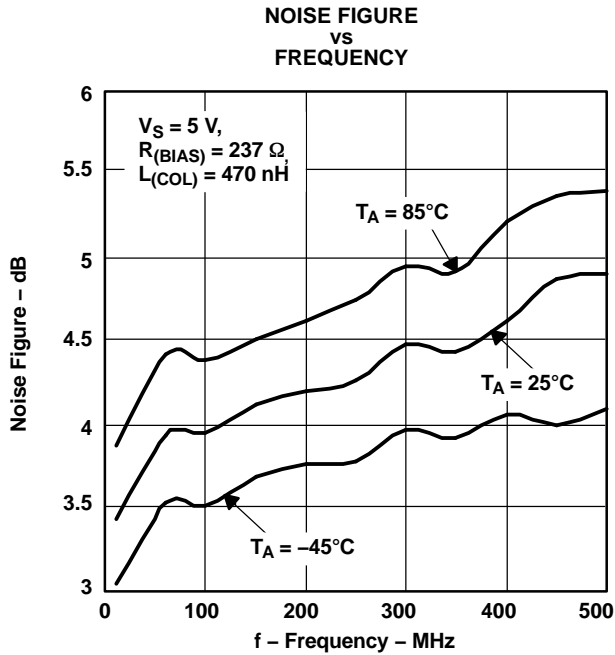

Figure 15.

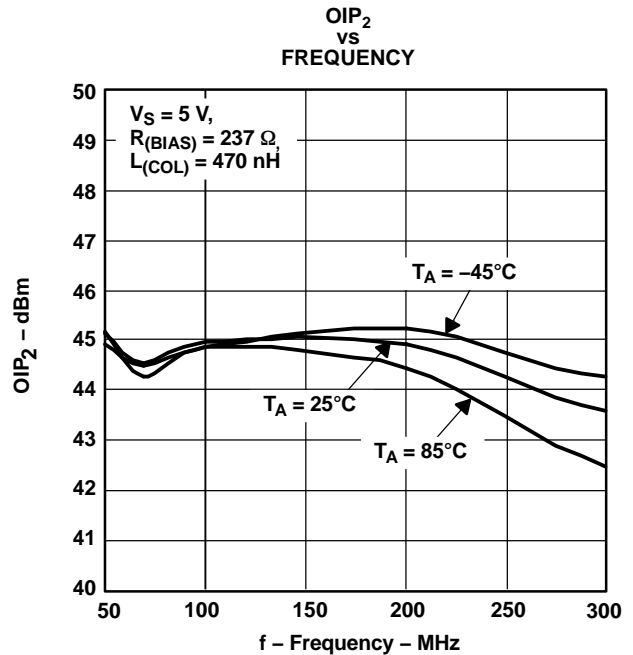

Figure 16.

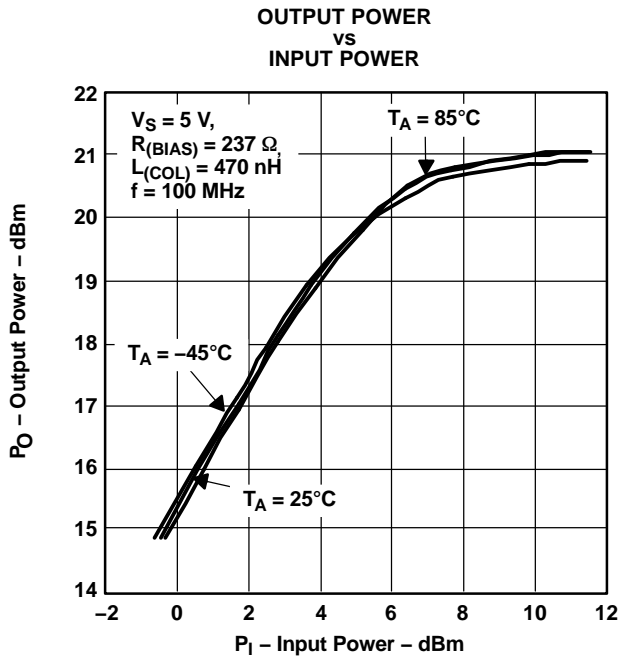

Figure 17.

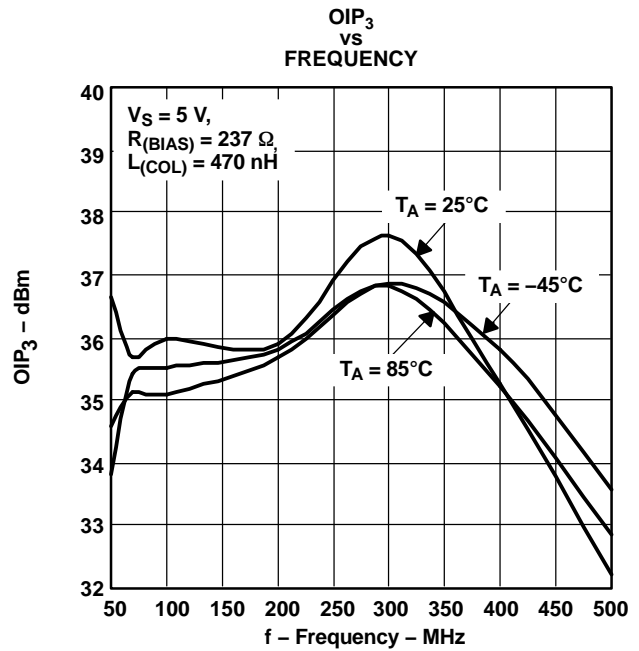

Figure 18.

TYPICAL CHARACTERISTICS
S-Parameters Tables of THS9000 with EVM De-Embedded

$V_S = 5\text{ V}$, $R_{(\text{BIAS})} = 237\ \Omega$, $L_{(\text{COL})} = 470\ \text{nH}$

Frequency (MHz)	S21		S11		S22		S12	
	Gain (dB)	Phase (deg)	Gain (dB)	Phase (deg)	Gain (dB)	Phase (deg)	Gain (dB)	Phase (deg)
1.0	-4.2	-169.5	-2.4	-0.9	-1.9	158.1	-63.1	167.0
5.0	11.3	-124.5	-1.5	-14.5	-2.6	138.0	-32.9	122.4
10.2	15.8	-147.8	-2.2	-42.3	-5.0	101.0	-24.0	80.4
19.7	16.4	-169.4	-6.5	-69.7	-10.5	66.6	-21.3	41.6
50.1	16.0	177.2	-15.6	-91.4	-16.7	30.1	-20.7	14.4
69.7	15.9	173.5	-19.8	-97.7	-17.8	17.7	-20.7	9.1
102.4	15.9	168.4	-26.9	-102.6	-18.2	4.3	-20.7	4.4
150.5	15.8	162.0	-39.0	14.1	-18.1	-8.6	-20.7	-0.7
198.1	15.7	155.8	-27.6	50.8	-17.4	-19.6	-20.7	-1.7
246.9	15.7	149.6	-23.7	40.6	-16.4	-26.7	-20.7	-3.5
307.6	15.6	141.9	-19.8	33.1	-14.9	-37.2	-20.6	-5.7
362.8	15.6	134.7	-17.3	24.7	-13.3	-44.3	-20.4	-7.7
405.0	15.6	129.2	-15.5	20.3	-12.1	-51.0	-20.2	-10.0
452.2	15.6	122.3	-13.8	14.7	-10.6	-58.1	-19.9	-12.5
504.7	15.5	114.9	-11.8	6.3	-9.0	-66.5	-19.7	-16.2
563.4	15.4	105.8	-9.7	-2.9	-7.2	-77.5	-19.4	-22.4
595.3	15.3	100.5	-8.6	-9.1	-6.3	-83.6	-19.3	-26.2
664.5	14.9	88.7	-6.3	-24.2	-4.4	-99.7	-19.3	-36.7
702.1	14.6	81.0	-5.3	-33.2	-3.7	-109.2	-19.6	-43.4
741.8	14.1	76.3	-4.4	-42.9	-3.0	-118.8	-19.9	-50.2
828.1	12.7	60.2	-2.9	-65.5	-2.3	-142.8	-21.7	-69.2
874.9	11.2	51.0	-2.5	-77.9	-2.5	-155.0	-23.6	-75.0
924.4	10.1	50.2	-2.4	-90.4	-3.1	-166.0	-25.8	-85.2
976.7	8.8	51.8	-2.5	-100.7	-4.3	-173.7	-28.4	-78.9
1031.9	9.2	58.2	-2.6	-108.7	-4.7	-175.2	-29.7	-68.7
1090.3	8.9	48.0	-2.5	-115.2	-4.4	-164.7	-31.4	-69.1
1151.9	8.8	39.9	-2.3	-123.3	-3.5	-175.4	-33.6	-83.4
1217.1	8.0	27.7	-2.1	-132.0	-3.0	175.3	-38.2	-81.4
1285.9	7.0	30.5	-2.0	-140.7	-2.8	168.7	-42.3	-25.5
1358.6	5.6	20.6	-1.9	-149.4	-2.9	159.1	-42.2	41.6
1435.5	4.3	19.5	-1.8	-159.4	-3.0	151.3	-38.7	63.3
1516.6	3.4	17.7	-1.9	-168.3	-3.2	144.7	-33.6	62.4
1602.4	2.8	16.5	-2.0	-177.2	-3.5	138.2	-30.5	59.6
1693.0	2.2	8.6	-2.1	174.0	-3.8	131.4	-28.1	56.2
1788.8	1.4	-0.7	-2.2	165.4	-4.1	124.6	-26.2	50.4
1889.9	0.5	-4.1	-2.3	157.0	-4.5	118.2	-24.7	42.4
1996.8	-0.6	-4.5	-2.6	150.0	-4.9	111.2	-24.2	39.5

APPLICATION INFORMATION

The THS9000 is a medium power, cascadeable, amplifier optimized for high intermediate frequencies in radios. The amplifier is unconditionally stable and the design requires only 2 dc-blocking capacitors, 1 power-supply bypass capacitor, 1 RF choke, and 1 bias resistor. Refer to Figure 25 for the circuit diagram.

The THS9000 operates with a power supply voltage ranging from 2.5 V to 5.5 V.

The value of $R_{(BIAS)}$ sets the bias current to the amplifier. Refer to Figure 10. This allows the designer to trade-off linearity versus power consumption. $R_{(BIAS)}$ can be removed without damage to the device.

Component selection of $C_{(BYP)}$, C_{IN} , and C_{OUT} is not critical. The values shown in Figure 25 were used for all the data shown in this data sheet.

The amplifier incorporates internal impedance matching to 50Ω that can be adjusted for various frequencies of operation by proper selection of $L_{(COL)}$.

Figure 19 shows the s-parameters of the part mounted on the standard EVM with $V_S = 5\text{ V}$, $R_{(BIAS)} = 237\Omega$, and $L_{(COL)} = 470\text{ nH}$. With this configuration, the part is very broadband, and achieves greater than 15-dB input and output return loss from 50 MHz to 325 MHz.

Figure 20 shows the S-parameters of the part mounted on the standard EVM with $V_S = 5\text{ V}$, $R_{(BIAS)} = 237\Omega$, and $L_{(COL)} = 68\text{ nH}$. With this configuration, the part achieves greater than 15-dB input and output return loss from 250 MHz to 400 MHz.

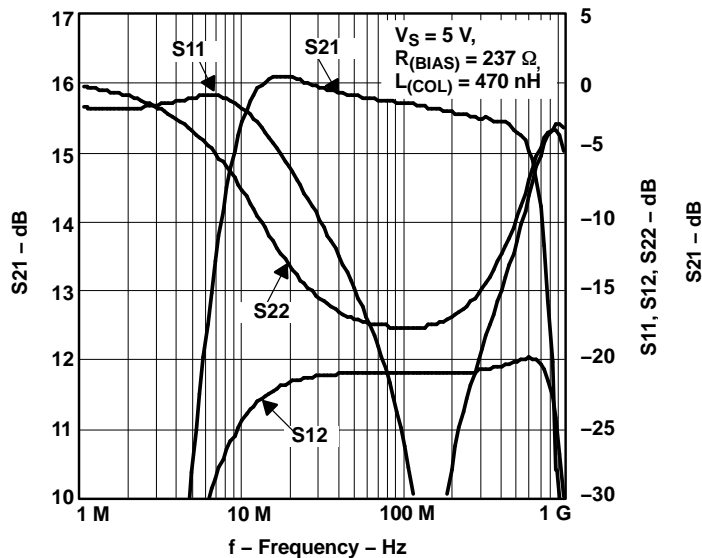

Figure 19. S-Parameters of THS9000 mounted on the standard EVM with $V_S = 5\text{ V}$, $R_{(BIAS)} = 237\Omega$, and $L_{(COL)} = 470\text{ nH}$

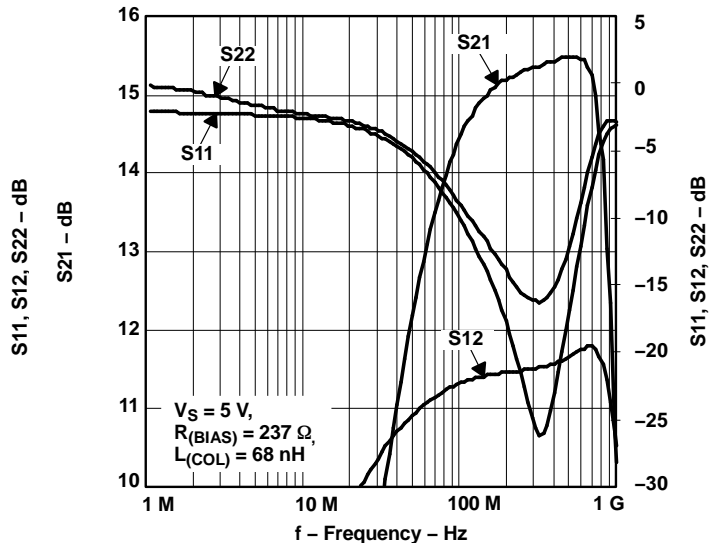

Figure 20. S-Parameters of THS9000 mounted on the standard EVM with $V_S = 5\text{ V}$, $R_{(BIAS)} = 237\Omega$, and $L_{(COL)} = 68\text{ nH}$

APPLICATION INFORMATION (continued)

Figure 21 Shows an example of a single conversion receiver architecture and where the THS9000 would typically be used.

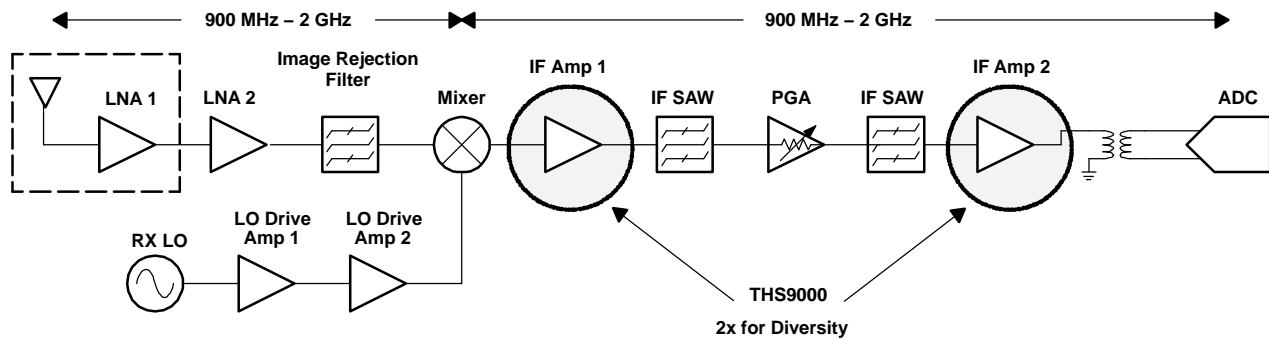

Figure 21. Example Single Conversion Receiver Architecture

Figure 22 shows an example of a dual conversion receiver architecture and where the THS9000 would typically be used.

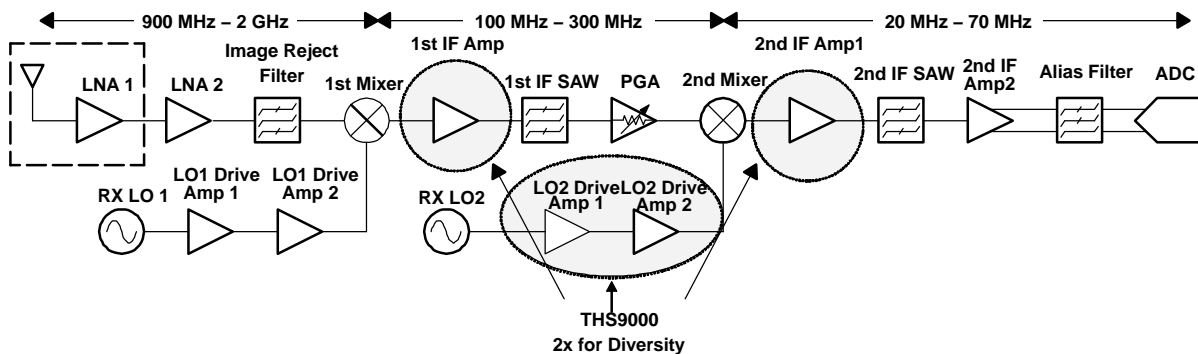

Figure 22. Example Dual Conversion Receiver Architecture

Figure 23 shows an example of a dual conversion transmitter architecture and where the THS9000 would typically be used.

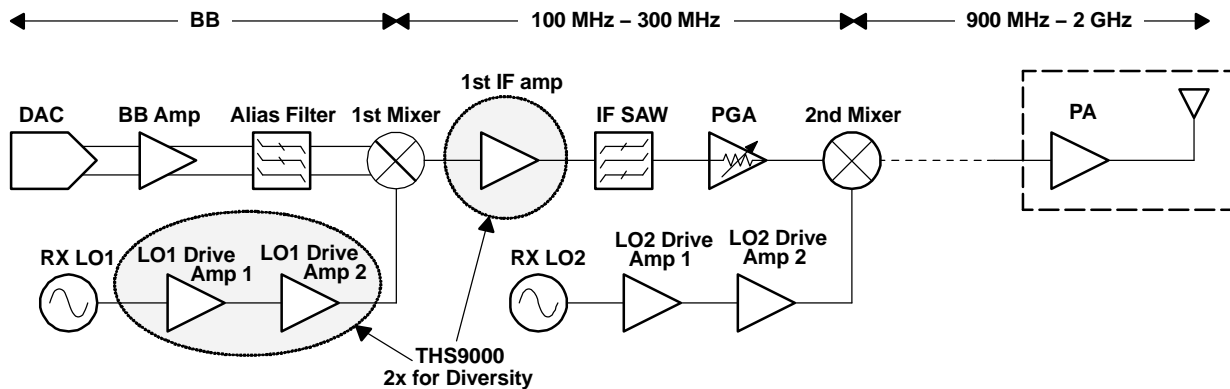
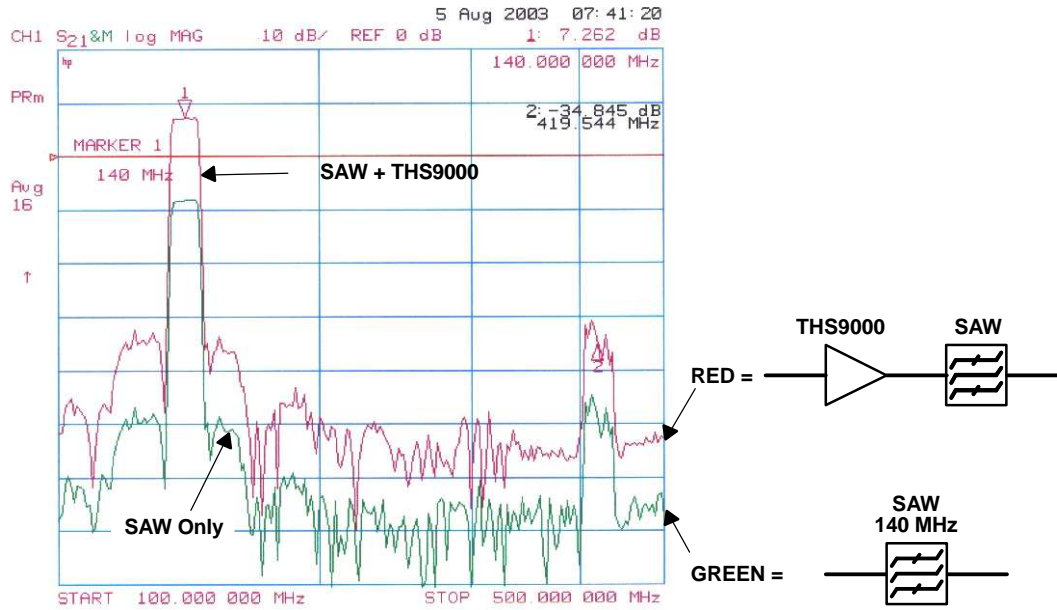

Figure 23. Example Dual Conversion Transmitter Architecture

Figure 24 shows the THS9000 and Sawtek #854916 SAW filter frequency response along with the frequency response of the SAW filter alone. The SAW filter has a center frequency of 140 MHz with 10-MHz bandwidth and 8-dB insertion loss. It can be seen that the frequency response with the THS9000 is the same as with the SAW except for a 15-dB gain. The THS9000 is mounted on the standard EVM with $V_S = 5\text{ V}$, $R_{(BIAS)} = 237\ \Omega$, and $L_{(COL)} = 470\text{ nH}$. Note the amplifier does not add artifacts to the signal.



140 MHz SAW: Sawtek #854916

Figure 24. Frequency Response of the THS9000 and SAW Filter, and SAW Filter Only

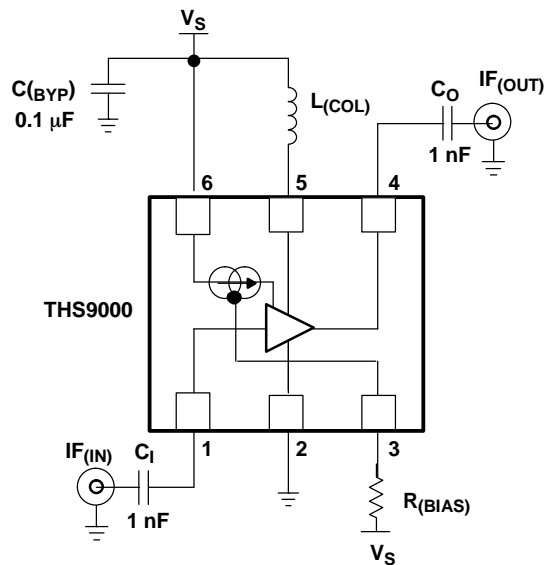

Figure 25. THS9000 Recommended Circuit (used for all tests)

Evaluation Module

Table 1 is the bill of materials, and Figure 26 and Figure 27 show the EVM layout.

Bill Of Materials

ITEM	DESCRIPTION	REF DES	QTY	PART NUMBER ⁽¹⁾
1	Cap, 0.1 μ F, ceramic, X7R, 50 V	C1	1	(AVX) 08055C104KAT2A
2	Cap, 1000 pF, ceramic, NPO, 100 V	C2, C3	2	(AVX) 08051A102JAT2A
3	Inductor, 470 nH, 5%	L1	1	(Coilcraft) 0805CS-471XJBC
4	Resistor, 237 Ω , 1/8 W, 1%	R1	1	(Phycomp) 9C08052A2370FKHFT
5	Open	TR1	1	
6	Jack, banana receptance, 0.25" dia.	J3, J4	2	(SPC) 813
7	Connector, edge, SMA PCB jack	J1, J2	2	(Johnson) 142-0701-801
8	Standoff, 4-40 Hex, 0.625" Length		4	(KEYSTONE) 1808
9	Screw, Phillips, 4-40, .250"		4	SHR-0440-016-SN
10	IC, THS9000	U1	1	(TI) THS9000DRD
11	Board, printed-circuit		1	(TI) EDGE # 6453521 Rev.A

(1) The manufacturer's part numbers are used for test purposes only.

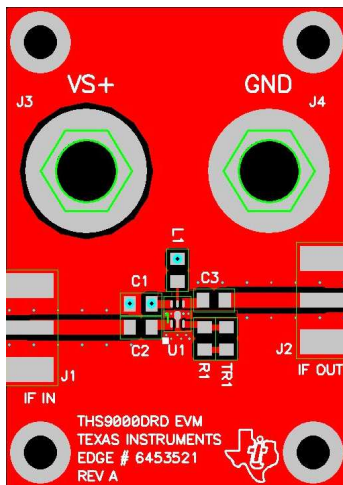

Figure 26. EVM Top Layout

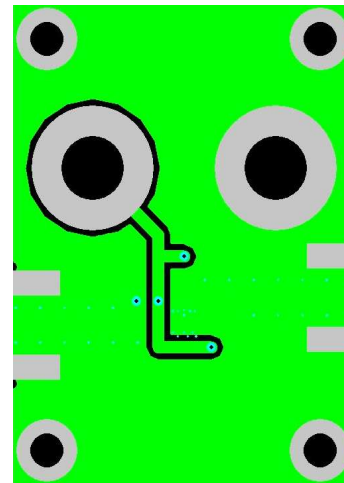

Figure 27. EVM Bottom Layout

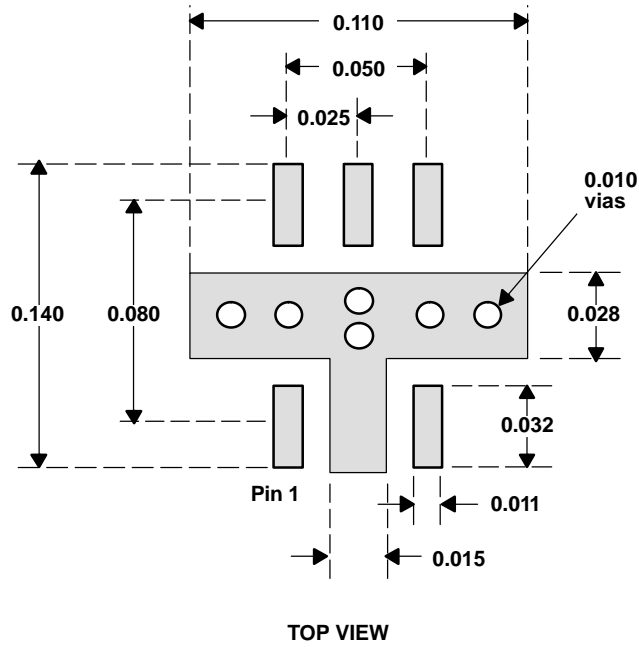

Figure 28. THS9000 Recommended Footprint (dimensions in inches)

PACKAGING INFORMATION

Orderable Device	Status ⁽¹⁾	Package Type	Package Drawing	Pins	Package Qty	Eco Plan ⁽²⁾	Lead/Ball Finish	MSL Peak Temp ⁽³⁾
THS9000DRDR	ACTIVE	SON	DRD	6	3000	TBD	CU SNPB	Level-1-220C-UNLIM
THS9000DRDT	ACTIVE	SON	DRD	6	250	TBD	CU SNPB	Level-1-220C-UNLIM

⁽¹⁾ The marketing status values are defined as follows:

ACTIVE: Product device recommended for new designs.

LIFEBUY: TI has announced that the device will be discontinued, and a lifetime-buy period is in effect.

NRND: Not recommended for new designs. Device is in production to support existing customers, but TI does not recommend using this part in a new design.

PREVIEW: Device has been announced but is not in production. Samples may or may not be available.

OBsolete: TI has discontinued the production of the device.

⁽²⁾ Eco Plan - The planned eco-friendly classification: Pb-Free (RoHS), Pb-Free (RoHS Exempt), or Green (RoHS & no Sb/Br) - please check <http://www.ti.com/productcontent> for the latest availability information and additional product content details.

TBD: The Pb-Free/Green conversion plan has not been defined.

Pb-Free (RoHS): TI's terms "Lead-Free" or "Pb-Free" mean semiconductor products that are compatible with the current RoHS requirements for all 6 substances, including the requirement that lead not exceed 0.1% by weight in homogeneous materials. Where designed to be soldered at high temperatures, TI Pb-Free products are suitable for use in specified lead-free processes.

Pb-Free (RoHS Exempt): This component has a RoHS exemption for either 1) lead-based flip-chip solder bumps used between the die and package, or 2) lead-based die adhesive used between the die and leadframe. The component is otherwise considered Pb-Free (RoHS compatible) as defined above.

Green (RoHS & no Sb/Br): TI defines "Green" to mean Pb-Free (RoHS compatible), and free of Bromine (Br) and Antimony (Sb) based flame retardants (Br or Sb do not exceed 0.1% by weight in homogeneous material)

⁽³⁾ MSL, Peak Temp. -- The Moisture Sensitivity Level rating according to the JEDEC industry standard classifications, and peak solder temperature.

Important Information and Disclaimer:The information provided on this page represents TI's knowledge and belief as of the date that it is provided. TI bases its knowledge and belief on information provided by third parties, and makes no representation or warranty as to the accuracy of such information. Efforts are underway to better integrate information from third parties. TI has taken and continues to take reasonable steps to provide representative and accurate information but may not have conducted destructive testing or chemical analysis on incoming materials and chemicals. TI and TI suppliers consider certain information to be proprietary, and thus CAS numbers and other limited information may not be available for release.

In no event shall TI's liability arising out of such information exceed the total purchase price of the TI part(s) at issue in this document sold by TI to Customer on an annual basis.

MECHANICAL DATA

DRD (S-PDSO-N6)

PLASTIC SMALL OUTLINE

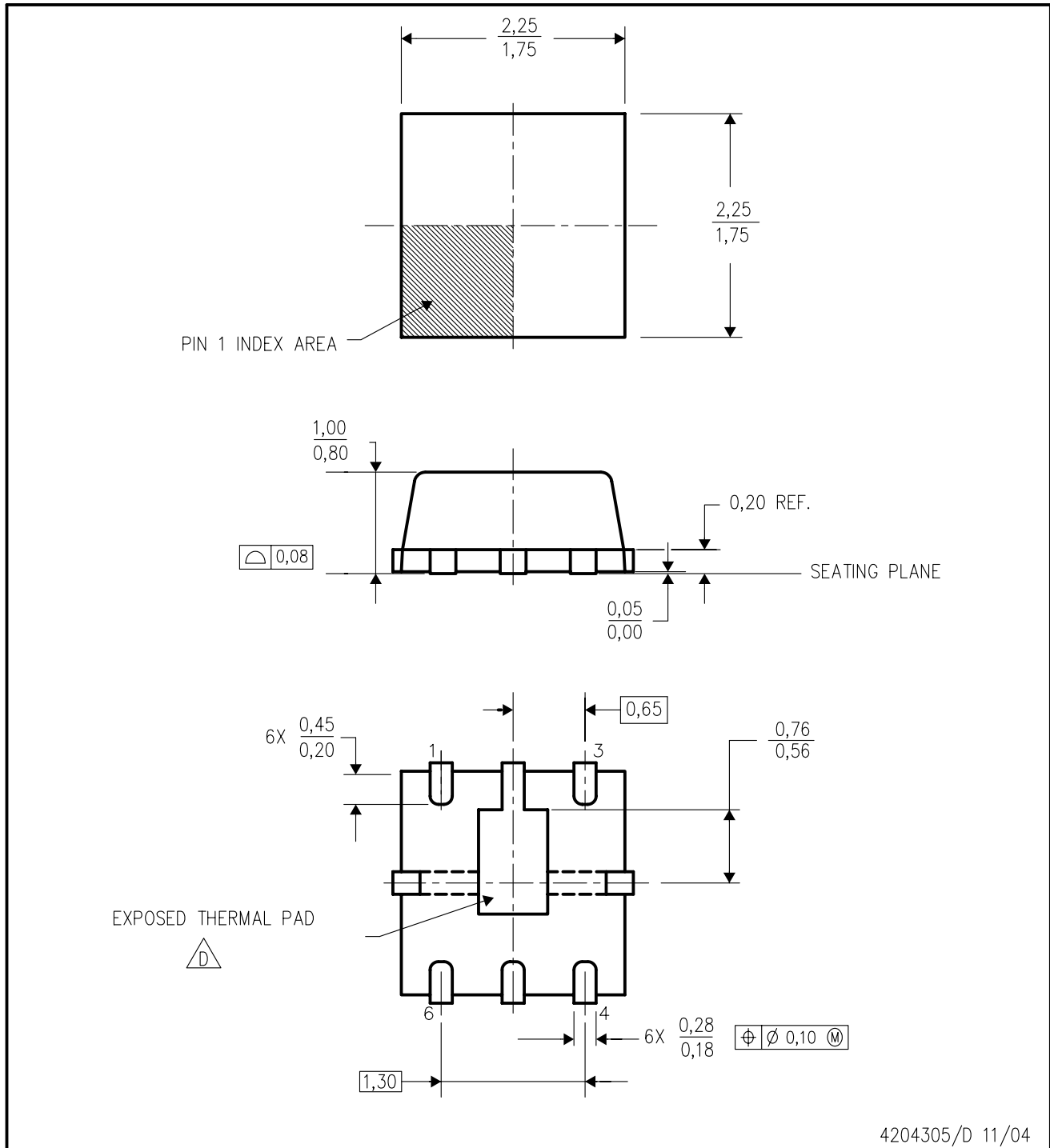

- NOTES:
- A. All linear dimensions are in millimeters. Dimensioning and tolerancing per ASME Y14.5M-1994.
 - B. This drawing is subject to change without notice.
 - C. Small Outline No-Lead (SON) package configuration.
 -  The package thermal pad must be soldered to the board for thermal and mechanical performance. See the Product Data Sheet for details regarding the exposed thermal pad dimensions.

IMPORTANT NOTICE

Texas Instruments Incorporated and its subsidiaries (TI) reserve the right to make corrections, modifications, enhancements, improvements, and other changes to its products and services at any time and to discontinue any product or service without notice. Customers should obtain the latest relevant information before placing orders and should verify that such information is current and complete. All products are sold subject to TI's terms and conditions of sale supplied at the time of order acknowledgment.

TI warrants performance of its hardware products to the specifications applicable at the time of sale in accordance with TI's standard warranty. Testing and other quality control techniques are used to the extent TI deems necessary to support this warranty. Except where mandated by government requirements, testing of all parameters of each product is not necessarily performed.

TI assumes no liability for applications assistance or customer product design. Customers are responsible for their products and applications using TI components. To minimize the risks associated with customer products and applications, customers should provide adequate design and operating safeguards.

TI does not warrant or represent that any license, either express or implied, is granted under any TI patent right, copyright, mask work right, or other TI intellectual property right relating to any combination, machine, or process in which TI products or services are used. Information published by TI regarding third-party products or services does not constitute a license from TI to use such products or services or a warranty or endorsement thereof. Use of such information may require a license from a third party under the patents or other intellectual property of the third party, or a license from TI under the patents or other intellectual property of TI.

Reproduction of information in TI data books or data sheets is permissible only if reproduction is without alteration and is accompanied by all associated warranties, conditions, limitations, and notices. Reproduction of this information with alteration is an unfair and deceptive business practice. TI is not responsible or liable for such altered documentation.

Resale of TI products or services with statements different from or beyond the parameters stated by TI for that product or service voids all express and any implied warranties for the associated TI product or service and is an unfair and deceptive business practice. TI is not responsible or liable for any such statements.

Following are URLs where you can obtain information on other Texas Instruments products and application solutions:

Products		Applications	
Amplifiers	amplifier.ti.com	Audio	www.ti.com/audio
Data Converters	dataconverter.ti.com	Automotive	www.ti.com/automotive
DSP	dsp.ti.com	Broadband	www.ti.com/broadband
Interface	interface.ti.com	Digital Control	www.ti.com/digitalcontrol
Logic	logic.ti.com	Military	www.ti.com/military
Power Mgmt	power.ti.com	Optical Networking	www.ti.com/opticalnetwork
Microcontrollers	microcontroller.ti.com	Security	www.ti.com/security
		Telephony	www.ti.com/telephony
		Video & Imaging	www.ti.com/video
		Wireless	www.ti.com/wireless

Mailing Address: Texas Instruments
Post Office Box 655303 Dallas, Texas 75265