



SBVS031D – MARCH 2001 – REVISED SEPTEMBER 2005

# DMOS

## 400mA Low-Dropout Regulator

### FEATURES

- **CAP-FREE DMOS TOPOLOGY:**  
 Ultra Low Dropout Voltage:  
 250mV typ at 400mA  
 Output Capacitor *not* Required for Stability
- **UP TO 500mA PEAK, TYPICAL**
- **FAST TRANSIENT RESPONSE**
- **VERY LOW NOISE: 28 $\mu$ Vrms**
- **HIGH ACCURACY:  $\pm$ 1.5% max**
- **HIGH EFFICIENCY:**  
 $I_{GND} = 850\mu A$  at  $I_{OUT} = 400mA$   
 Not Enabled:  $I_{GND} = 0.01\mu A$
- **2.5V, 2.85V, 3.0V, 3.3V, AND 5.0V OUTPUT VERSIONS**
- **OTHER OUTPUT VOLTAGES AVAILABLE UPON REQUEST**
- **FOLDBACK CURRENT LIMIT**
- **THERMAL PROTECTION**
- **SMALL SURFACE-MOUNT PACKAGES:**  
 SOT23-5 and MSOP-8

### APPLICATIONS

- **PORTABLE COMMUNICATION DEVICES**
- **BATTERY-POWERED EQUIPMENT**
- **PERSONAL DIGITAL ASSISTANTS**
- **MODEMS**
- **BAR-CODE SCANNERS**
- **BACKUP POWER SUPPLIES**

### DESCRIPTION

The REG113 is a family of low-noise, low-dropout linear regulators with low ground pin current. Its new DMOS topology provides significant improvement over previous designs, including low-dropout voltage (only 250mV typ at full load), and better transient performance. In addition, no output capacitor is required for stability, unlike conventional low-dropout regulators that are difficult to compensate and require expensive low ESR capacitors greater than 1 $\mu$ F.

Typical ground pin current is only 850 $\mu$ A (at  $I_{OUT} = 400mA$ ) and drops to 10nA when not enabled. Unlike regulators with PNP pass devices, quiescent current remains relatively constant over load variations and under dropout conditions.

The REG113 has very low output noise (typically 28 $\mu$ Vrms for  $V_{OUT} = 3.3V$  with  $C_{NR} = 0.01\mu F$ ), making it ideal for use in portable communications equipment. Accuracy is maintained over temperature, line, and load variations. Key parameters are tested over the specified temperature range ( $-40^{\circ}C$  to  $+85^{\circ}C$ ).

The REG113 is well protected—internal circuitry provides a current limit which protects the load from damage, furthermore, thermal protection circuitry keeps the chip from being damaged by excessive temperature. The REG113 is available in SOT23-5 and MSOP-8 packages.

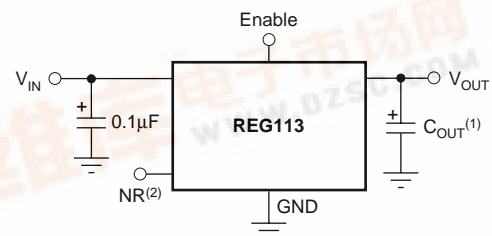

NOTES: (1) Optional. (2) NR = Noise Reduction.

Please be aware that an important notice concerning availability, standard warranty, and use in critical applications of Texas Instruments semiconductor products and disclaimers thereto appears at the end of this data sheet.

All trademarks are the property of their respective owners.

PRODUCTION DATA information is current as of publication date. Products conform to specifications per the terms of Texas Instruments standard warranty. Production processing does not necessarily include



Copyright © 2001-2005, Texas Instruments Incorporated

## ABSOLUTE MAXIMUM RATINGS<sup>(1)</sup>

Supply Input Voltage, $V_{IN}$ .....	-0.3V to 12V
Enable Input Voltage, $V_{EN}$ .....	-0.3V to $V_{IN}$
NR Pin Voltage, $V_{NR}$ .....	-0.3V to 6.0V
Output Short-Circuit Duration .....	Indefinite
Operating Temperature Range ( $T_J$ ) .....	-55°C to +125°C
Storage Temperature Range ( $T_A$ ) .....	-65°C to +150°C
Lead Temperature (soldering, 3s) .....	+240°C

NOTE: (1) Stresses above these ratings may cause permanent damage. Exposure to absolute maximum conditions for extended periods may degrade device reliability.



## ELECTROSTATIC DISCHARGE SENSITIVITY

This integrated circuit can be damaged by ESD. Texas Instruments recommends that all integrated circuits be handled with appropriate precautions. Failure to observe proper handling and installation procedures can cause damage.

ESD damage can range from subtle performance degradation to complete device failure. Precision integrated circuits may be more susceptible to damage because very small parametric changes could cause the device not to meet its published specifications.

## PACKAGE/ORDERING INFORMATION<sup>(1)</sup>

PRODUCT	$V_{OUT}$ <sup>(2)</sup>
REG113xx-yyyy/zzz	<p><b>XX</b> is package designator.</p> <p><b>YYYY</b> is typical output voltage (5 = 5.0V, 2.85 = 2.85V, A = Adjustable).</p> <p><b>ZZZ</b> is package quantity.</p>

(1) For the most current package and ordering information, see the Package Option Addendum at the end of this document, or see the TI website at [www.ti.com](http://www.ti.com).

(2) Output voltages from 2.5V to 5.1V in 50mV increments are available; minimum order quantities apply. Contact factory for details and availability.

## PIN CONFIGURATIONS

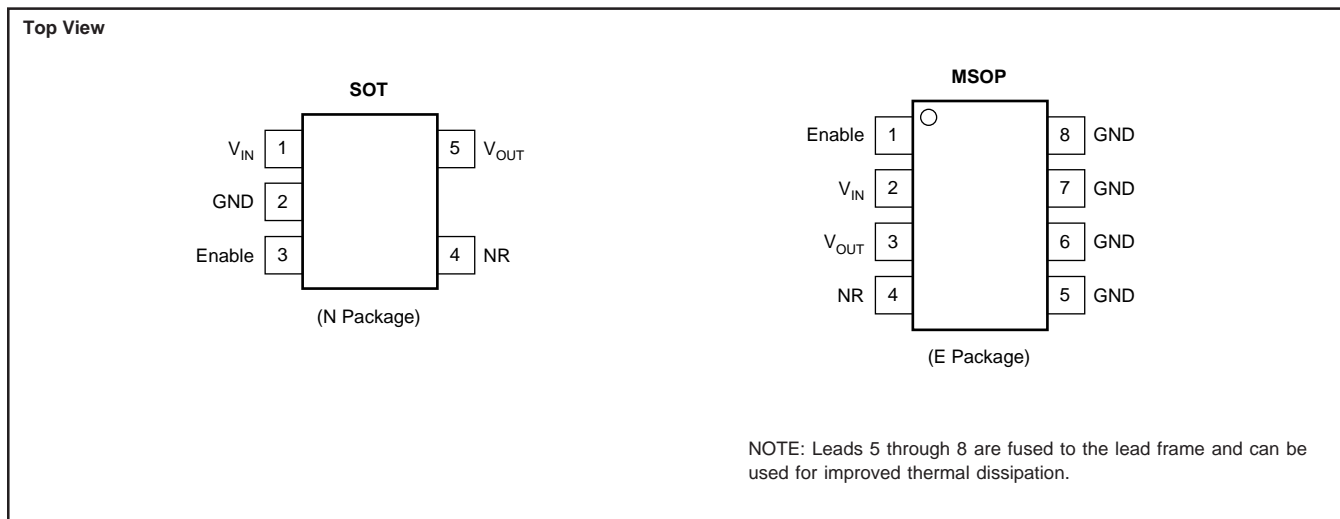



# TYPICAL CHARACTERISTICS

For all models, at  $T_J = +25^\circ\text{C}$  and  $V_{\text{ENABLE}} = 1.8\text{V}$ , unless otherwise noted.

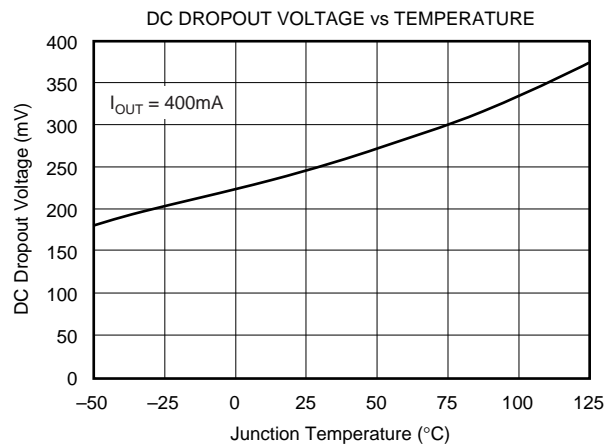
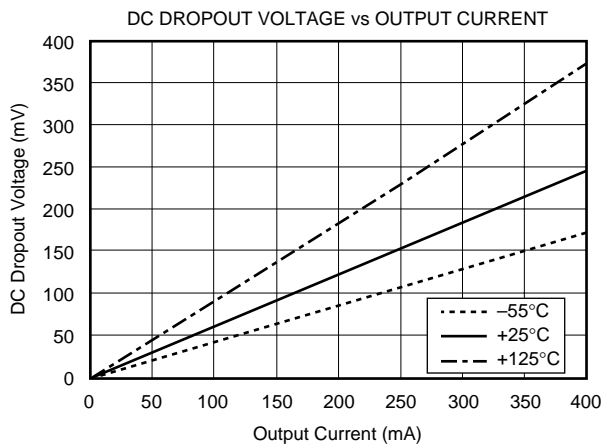
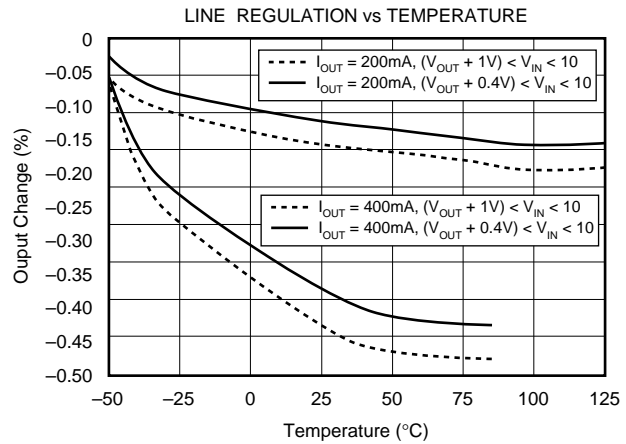
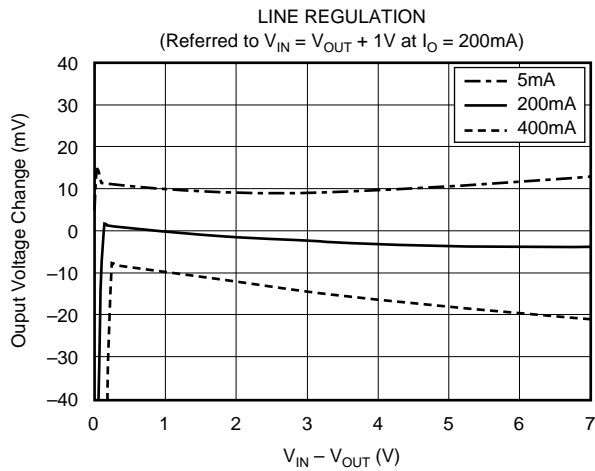
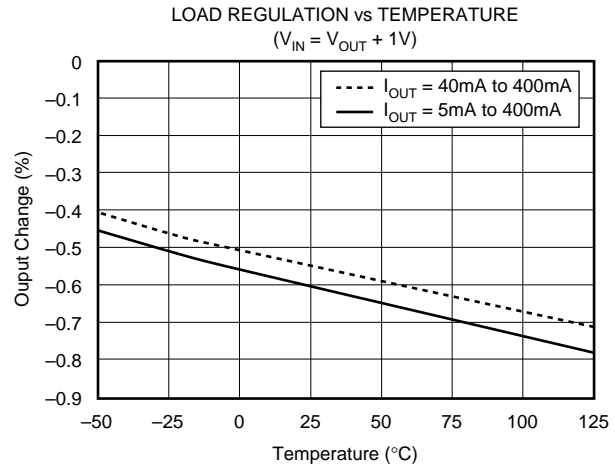
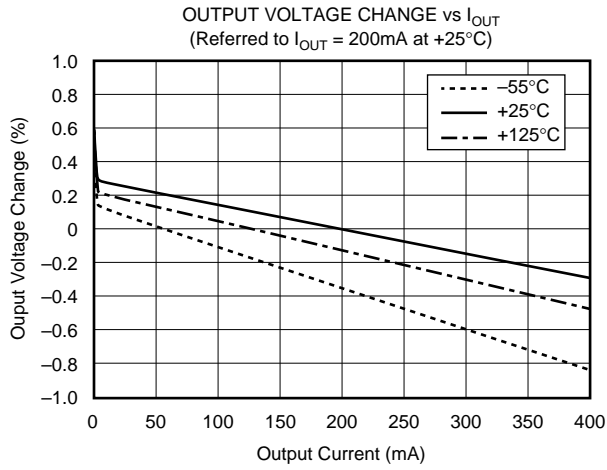

# TYPICAL CHARACTERISTICS (Cont.)

For all models, at  $T_J = +25^\circ\text{C}$  and  $V_{\text{ENABLE}} = 1.8\text{V}$ , unless otherwise noted.

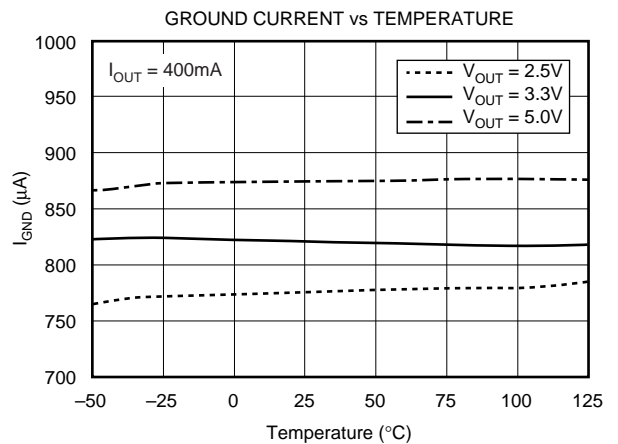
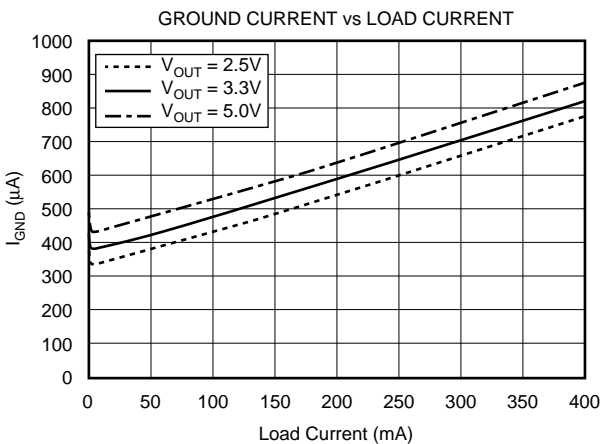
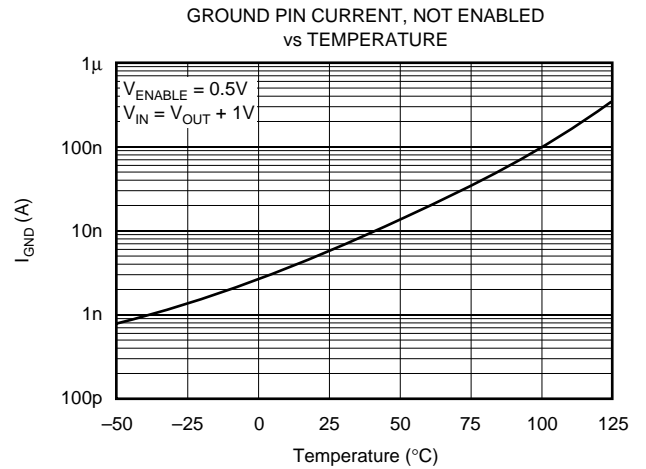
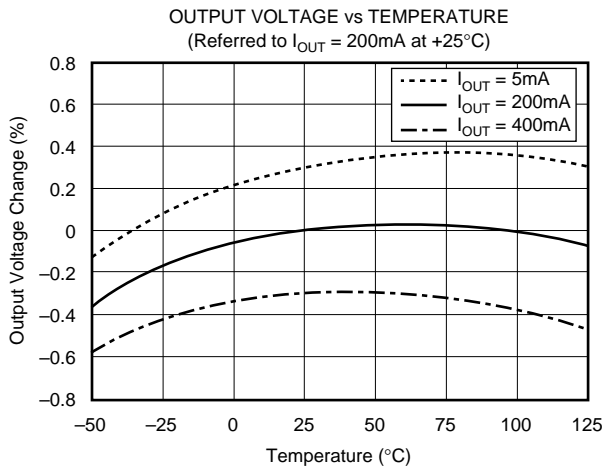
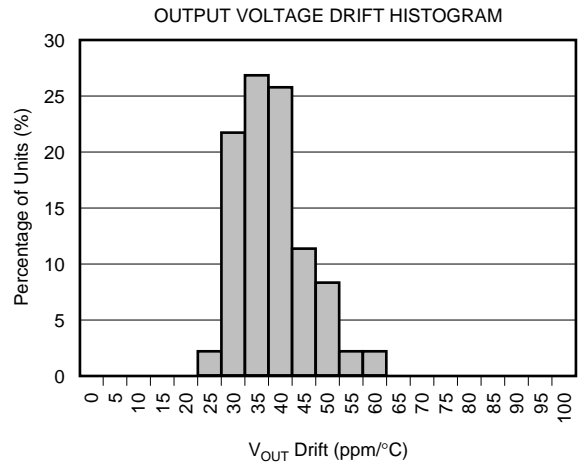
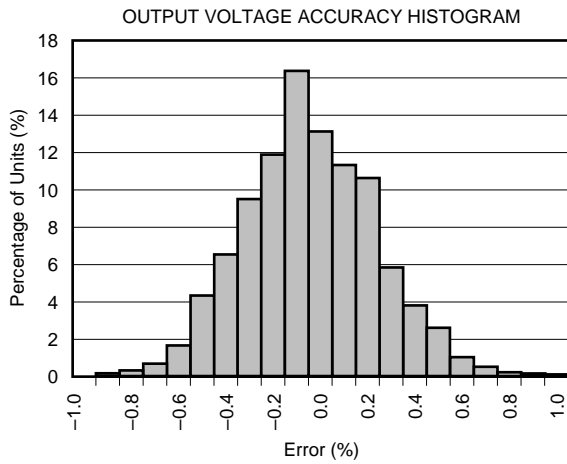

# TYPICAL CHARACTERISTICS (Cont.)

For all models, at  $T_J = +25^\circ\text{C}$  and  $V_{\text{ENABLE}} = 1.8\text{V}$ , unless otherwise noted.

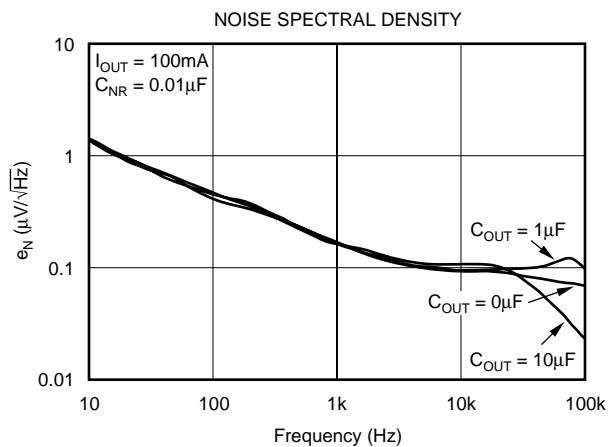
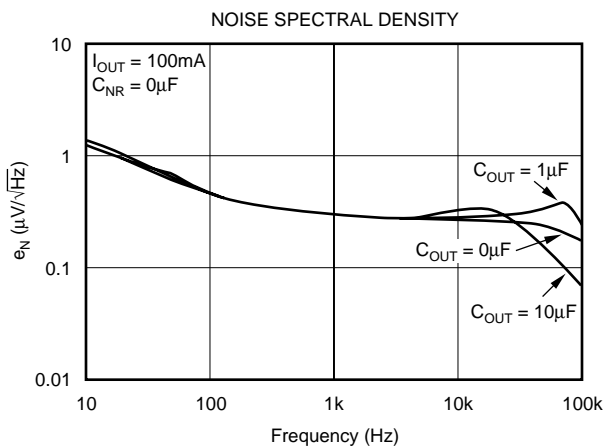
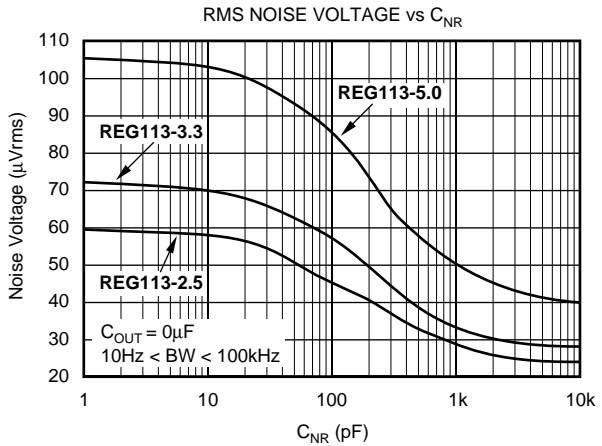
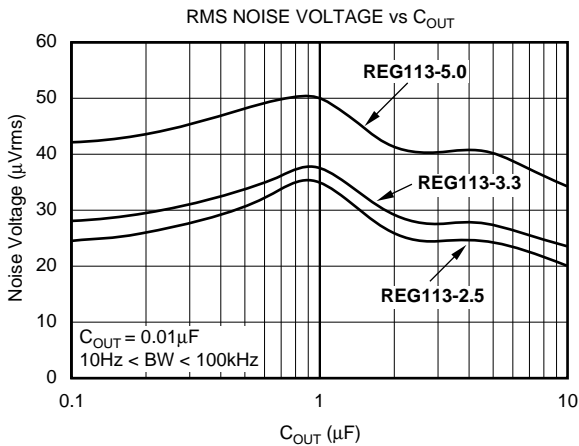
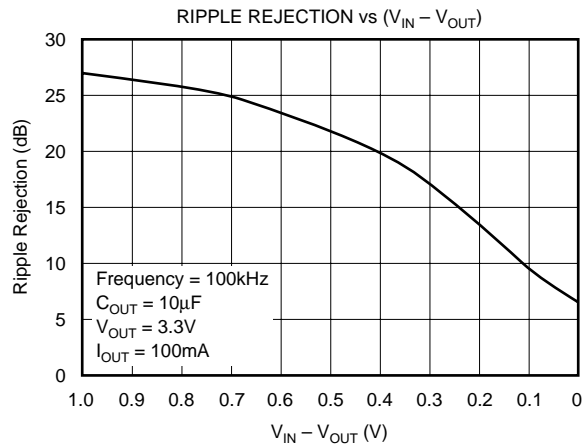
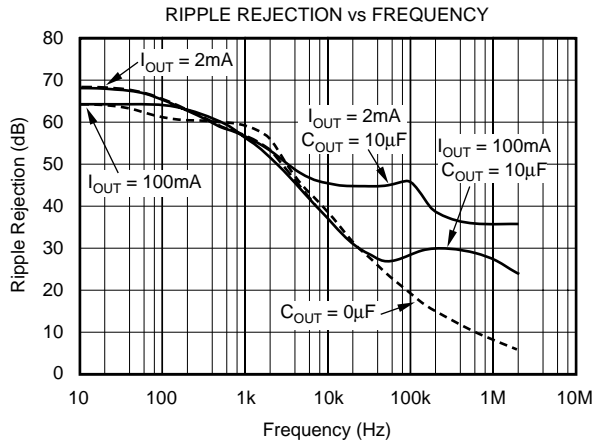

# TYPICAL CHARACTERISTICS (Cont.)

For all models, at  $T_J = +25^\circ\text{C}$  and  $V_{\text{ENABLE}} = 1.8\text{V}$ , unless otherwise noted.

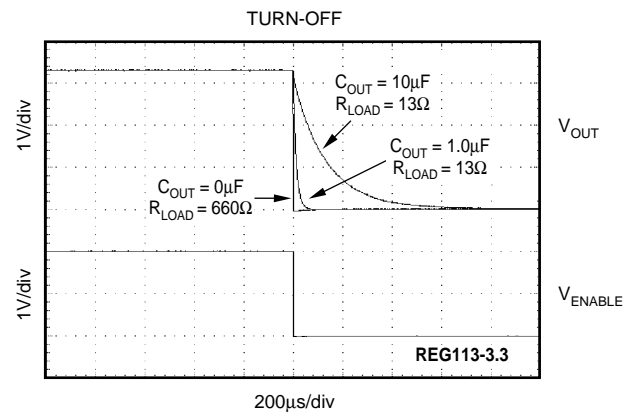
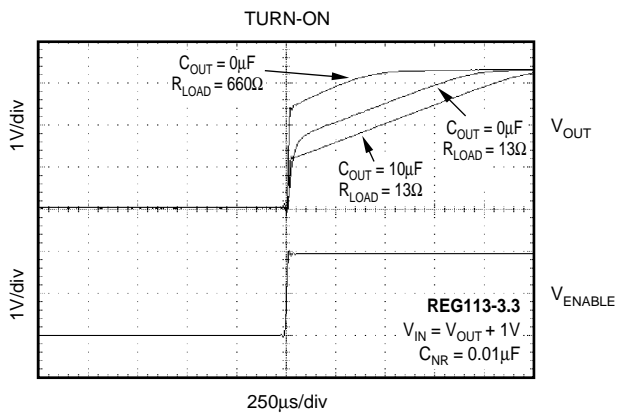
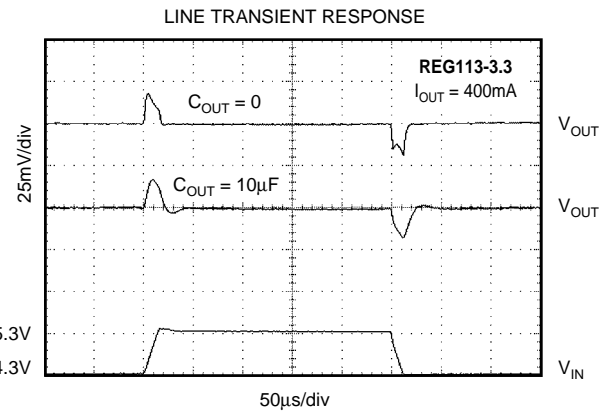
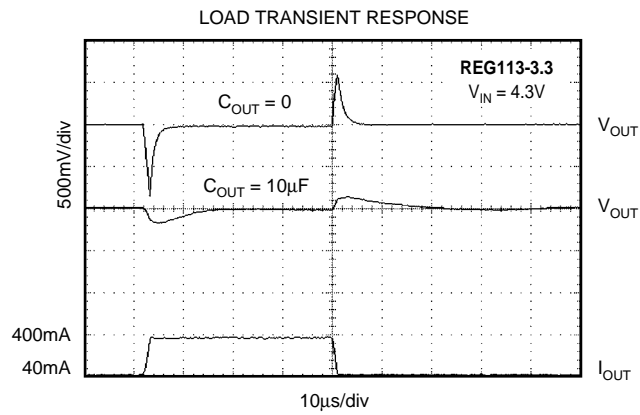
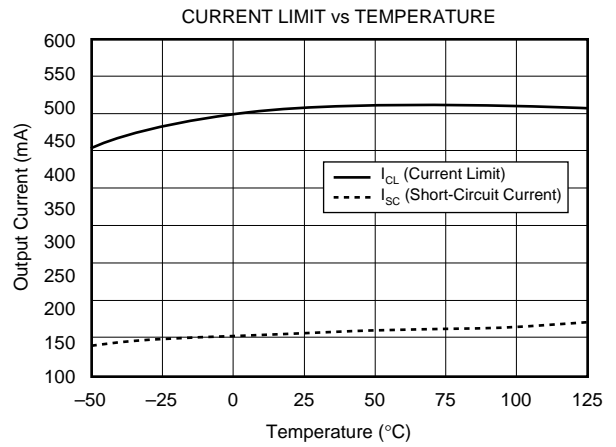
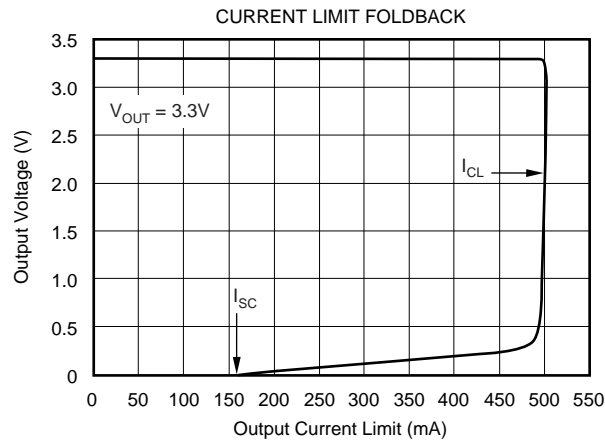

# TYPICAL CHARACTERISTICS (Cont.)

For all models, at  $T_J = +25^\circ\text{C}$  and  $V_{\text{ENABLE}} = 1.8\text{V}$ , unless otherwise noted.

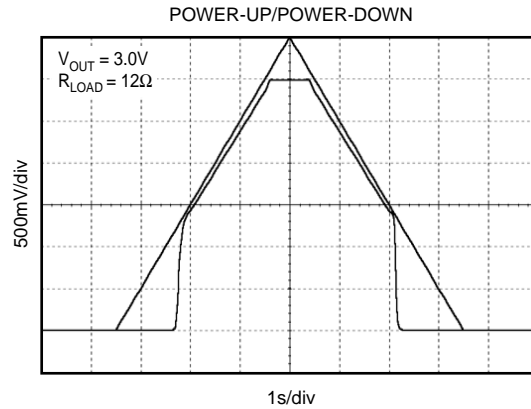
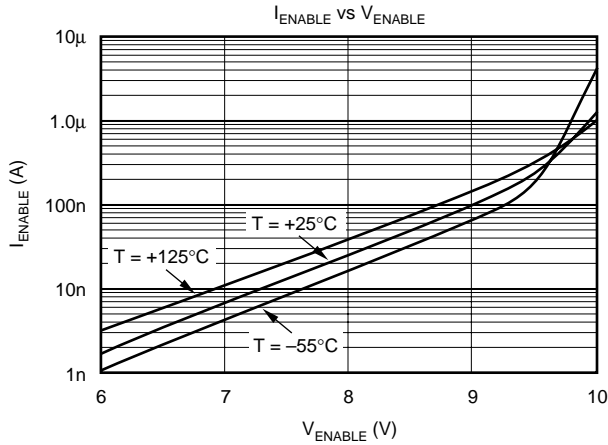

## BASIC OPERATION

The REG113 series of LDO (low dropout) linear regulators offers a wide selection of fixed output voltage versions and an adjustable output version. The REG113 belongs to a family of new generation LDO regulators that use a DMOS pass transistor to achieve ultra low-dropout performance and freedom from output capacitor constraints. Ground pin current remains under 1mA over all line, load, and temperature conditions. All versions have thermal and over-current protection, including foldback current limit.

The REG113 does not require an output capacitor for regulator stability and is stable over most output currents and with almost any value and type of output capacitor up to  $10\mu\text{F}$  or more. For applications where the regulator output current drops below several milliamps, stability can be enhanced by adding a  $1\text{k}\Omega$  to  $2\text{k}\Omega$  load resistor, using capacitance values smaller than  $10\mu\text{F}$ , or keeping the effective series resistance greater than  $0.05\Omega$  including the capacitor ESR and parasitic resistance in printed circuit board traces, solder joints, and sockets.

Although an input capacitor is not required, it is a good standard analog design practice to connect a  $0.1\mu\text{F}$  low ESR capacitor across the input supply voltage; this is recommended to counteract reactive input sources and improve ripple rejection by reducing input voltage ripple. Figure 1 shows the basic circuit connections for the fixed voltage models.

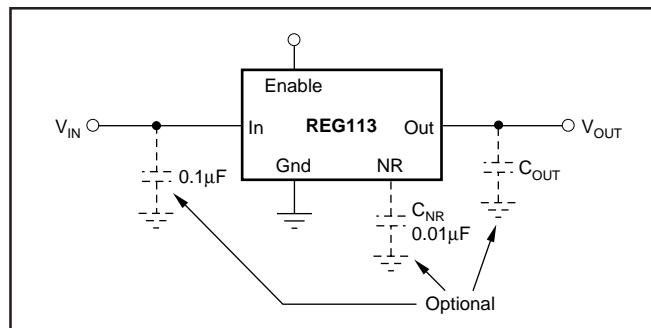

FIGURE 1. Fixed Voltage Nominal Circuit for the REG113.

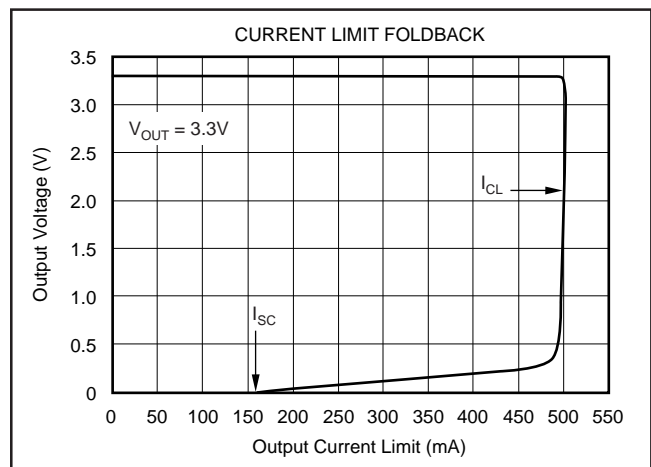

FIGURE 2. Foldback Current Limit of the REG113-3.3 at  $25^\circ\text{C}$ .

## INTERNAL CURRENT LIMIT

The REG113 internal current limit has a typical value of 500mA. A foldback feature limits the short-circuit current to a typical short-circuit value of 200mA. A curve of  $V_{\text{OUT}}$  versus  $I_{\text{OUT}}$  is given in Figure 2, and in the Typical Characteristics section.

## ENABLE

The Enable pin is active high and compatible with standard TTL-CMOS levels. Inputs below 0.5V (max) turn the regulator off and all circuitry is disabled. Under this condition, ground pin current drops to approximately 10nA. When not used, the Enable pin can be connected to  $V_{\text{IN}}$ .



## OUTPUT NOISE

A precision bandgap reference is used to generate the internal reference voltage,  $V_{REF}$ . This reference is the dominant noise source within the REG113 and generates approximately  $29\mu\text{V}_{\text{rms}}$  in the 10Hz to 100kHz bandwidth at the reference output. The regulator control loop gains up the reference noise, so that the noise voltage of the regulator is approximately given by:

$$V_N = 29\mu\text{V}_{\text{rms}} \frac{R_1 + R_2}{R_2} = 29\mu\text{V}_{\text{rms}} \cdot \frac{V_{\text{OUT}}}{V_{\text{REF}}} \quad (1)$$

Since the value of  $V_{REF}$  is 1.26V, this relationship reduces to:

$$V_N = 23 \frac{\mu\text{V}_{\text{rms}}}{\text{V}} \cdot V_{\text{OUT}} \quad (2)$$

Connecting a capacitor,  $C_{NR}$ , from the Noise Reduction (NR) pin to ground (as shown in Figure 3) forms a low-pass filter for the voltage reference. For  $C_{NR} = 10\text{nF}$ , the total noise in the 10Hz to 100kHz bandwidth is reduced by approximately a factor of 2.8 for  $V_{\text{OUT}} = 3.3\text{V}$ . This noise reduction effect is shown in Figure 4, and as *RMS Noise Voltage vs  $C_{NR}$*  in the Typical Characteristics section.

Noise can be further reduced by carefully choosing an output capacitor,  $C_{\text{OUT}}$ . Best overall noise performance is achieved with very low ( $< 0.22\mu\text{F}$ ) or very high ( $> 2.2\mu\text{F}$ ) values of  $C_{\text{OUT}}$  (see the *RMS Noise Voltage vs  $C_{\text{OUT}}$*  typical characteristic).

The REG113 uses an internal charge pump to develop an internal supply voltage sufficient to drive the gate of the DMOS pass element above  $V_{\text{IN}}$ . The charge-pump switching noise (nominal switching frequency = 2MHz) is not measurable at the output of the regulator over most values of  $I_{\text{OUT}}$  and  $C_{\text{OUT}}$ .

## DROPOUT VOLTAGE

The REG113 uses an N-channel DMOS as the pass element. When  $(V_{\text{IN}} - V_{\text{OUT}})$  is less than the dropout voltage ( $V_{\text{DROPOUT}}$ ), the DMOS pass device behaves like a resistor; therefore, for low values of  $(V_{\text{IN}} - V_{\text{OUT}})$ , the regulator input-to-output resistance is the  $R_{\text{ds(ON)}}$  of the DMOS pass element (typically  $600\text{m}\Omega$ ). For static (DC) loads, the REG113 will

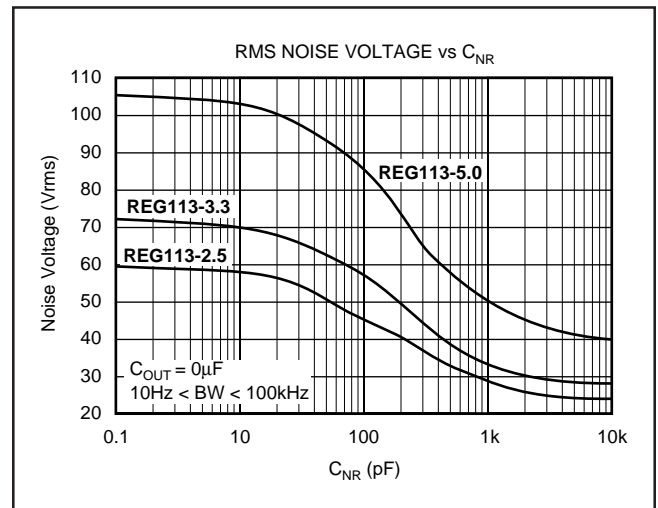

FIGURE 4. Output Noise versus Noise Reduction Capacitor.

typically maintain regulation down to a  $(V_{\text{IN}} - V_{\text{OUT}})$  voltage drop of 250mV at full rated output current. In Figure 5, the bottom line (DC dropout) shows the minimum  $V_{\text{IN}}$  to  $V_{\text{OUT}}$  voltage drop required to prevent dropout under DC load conditions.

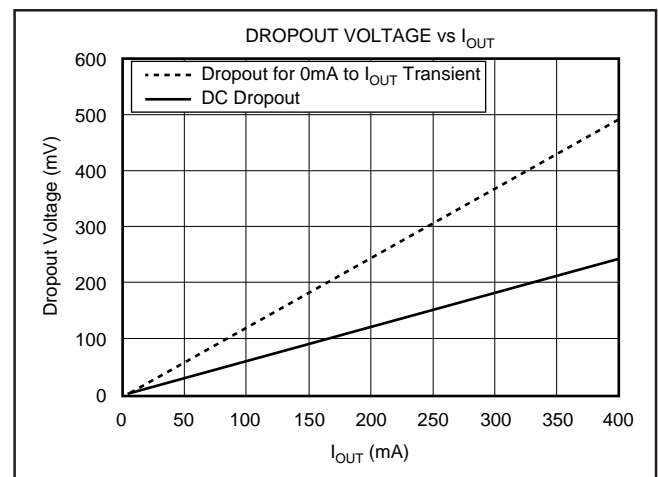

FIGURE 5. Transient and DC Dropout.

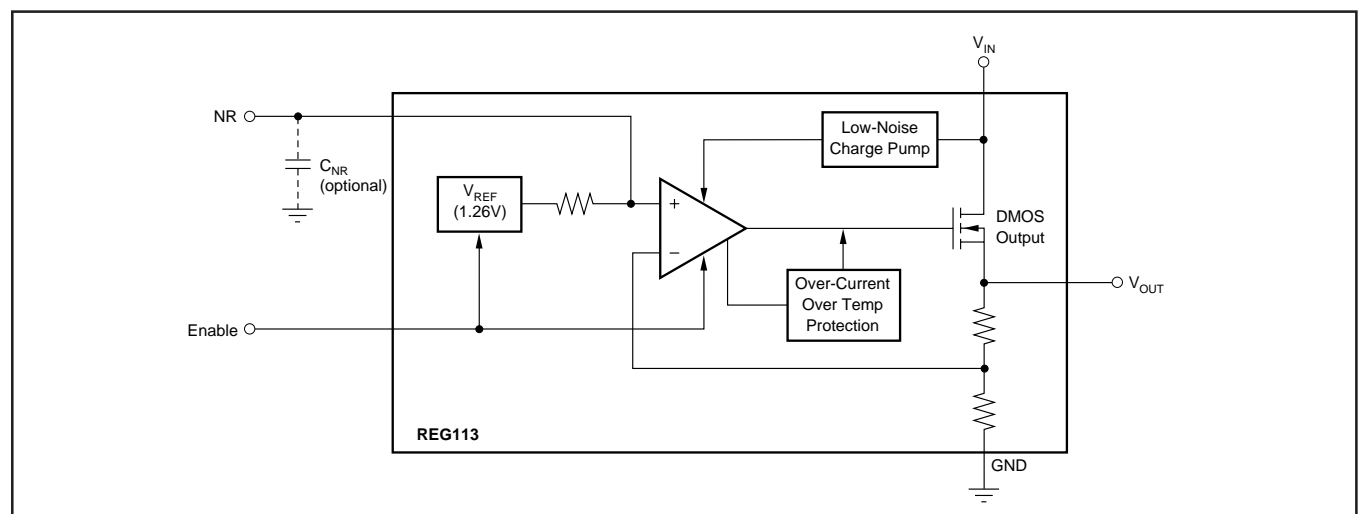

FIGURE 3. Block Diagram.

For large step changes in load current, the REG113 requires a larger voltage drop across it to avoid degraded transient response. The boundary of this transient dropout region is shown as the top line in Figure 5. Values of  $V_{IN}$  to  $V_{OUT}$  voltage drop above this line insure normal transient response.

In the transient dropout region between DC and Transient, transient response recovery time increases. The time required to recover from a load transient is a function of both the magnitude and rate of the step change in load current and the available headroom  $V_{IN}$  to  $V_{OUT}$  voltage drop. Under worst-case conditions (full-scale load change with  $(V_{IN} - V_{OUT})$  voltage drop close to DC dropout levels), the REG113 can take several hundred microseconds to re-enter the specified window of regulation.

### TRANSIENT RESPONSE

The REG113 response to transient line and load conditions improves at lower output voltages. The addition of a capacitor (nominal value  $0.47\mu\text{F}$ ) from the output pin to ground may improve the transient response. In the adjustable version, the addition of a capacitor,  $C_{FB}$  (nominal value  $10\text{nF}$ ), from the output to the adjust pin also improves the transient response.

### THERMAL PROTECTION

Power dissipated within the REG113 can cause the junction temperature to rise, however, the REG113 has thermal shutdown circuitry that protects the regulator from damage. The thermal protection circuitry disables the output when the junction temperature reaches approximately  $160^\circ\text{C}$ , allowing the device to cool. When the junction temperature cools to approximately  $140^\circ\text{C}$ , the output circuitry is again enabled. Depending on various conditions, the thermal protection circuit can cycle on and off. This limits the dissipation of the regulator, but can have an undesirable effect on the load.

Any tendency to activate the thermal protection circuit indicates excessive power dissipation or an inadequate heat sink. For reliable operation, junction temperature should be limited to  $125^\circ\text{C}$ , maximum. To estimate the margin of safety in a complete design (including heat sink), increase the ambient temperature until the thermal protection is triggered. Use worst-case loads and signal conditions. For good reliability, thermal protection should trigger more than  $35^\circ\text{C}$  above the maximum expected ambient condition of the application. This produces a worst-case junction temperature of  $125^\circ\text{C}$  at the highest expected ambient temperature and worst-case load.

The internal protection circuitry of the REG113 is designed to protect against overload conditions and is not intended to replace proper heat sinking. Continuously running the REG113 into thermal shutdown will degrade reliability.

### POWER DISSIPATION

The REG113 is available in two different package configurations. The ability to remove heat from the die is different for each package type and, therefore, presents different considerations in the printed circuit board (PCB) layout. On the MSOP-8 package, leads 5 through 8 are fused to the lead frame and may be used to improve the thermal performance of the package. The PCB area around the device that is free of other components moves the heat from the device to the ambient air. Although it is difficult or impossible to quantify all of the variables in a thermal design of this type, performance data for several simplified configurations are shown in Figure 6. In all cases the PCB copper area is bare copper, free of solder resist mask, and not solder plated. All examples are for 1-ounce copper and in the case of the MSOP-8, the copper area is connected to fused leads 5 to 8. See Figure 7 for thermal resistance for varying areas of copper. Using heavier copper can increase the effectiveness in removing the heat from the device. In those examples where there is copper on both sides of the PCB, no connection has been provided between the two sides. The addition of plated through holes will improve the heat sink effectiveness.

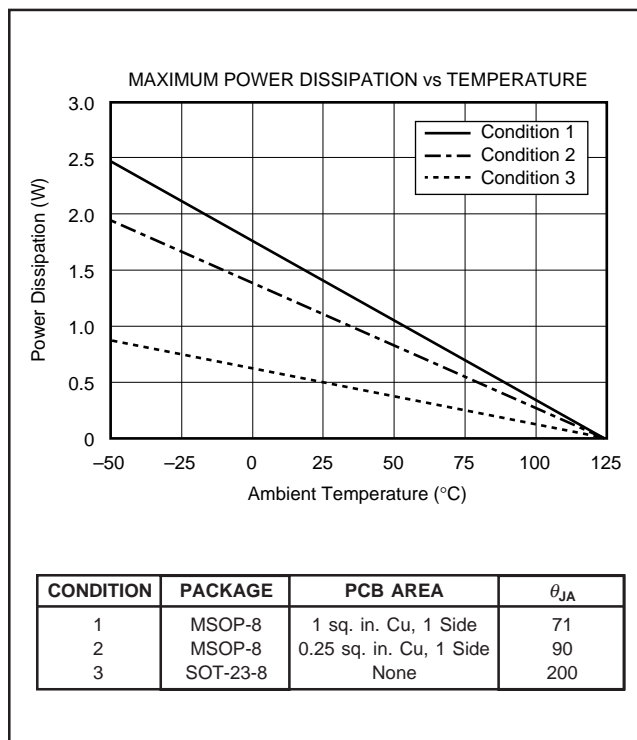

FIGURE 6. Maximum Power Dissipation versus Ambient Temperature for the Various Packages and PCB Heat Sink Configurations.

Power dissipation depends on input voltage, load conditions, and duty cycle and is equal to the product of the average output current times the voltage across the output element ( $V_{IN}$  to  $V_{OUT}$  voltage drop):

$$P_D = (V_{IN} - V_{OUT}) \cdot I_{OUT} \quad (3)$$

Power dissipation can be minimized by using the lowest possible input voltage necessary to assure the required output voltage.

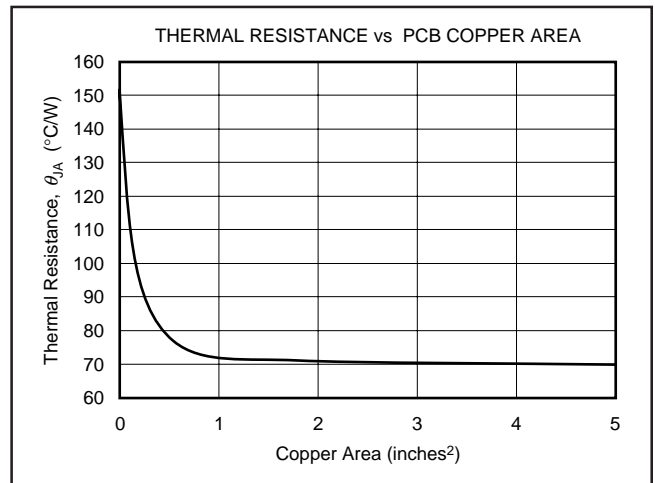

FIGURE 7. Thermal Resistance versus PCB Area for the MSOP-8.

**PACKAGING INFORMATION**

Orderable Device	Status <sup>(1)</sup>	Package Type	Package Drawing	Pins	Package Qty	Eco Plan <sup>(2)</sup>	Lead/Ball Finish	MSL Peak Temp <sup>(3)</sup>
REG113EA-2.5/250	ACTIVE	MSOP	DGK	8	250	Green (RoHS & no Sb/Br)	CU NIPDAU	Level-2-260C-1 YEAR
REG113EA-2.5/2K5	ACTIVE	MSOP	DGK	8	2500	Green (RoHS & no Sb/Br)	CU NIPDAU	Level-2-260C-1 YEAR
REG113EA-2.85/250	ACTIVE	MSOP	DGK	8	250	Green (RoHS & no Sb/Br)	CU NIPDAU	Level-2-260C-1 YEAR
REG113EA-2.85/2K5	ACTIVE	MSOP	DGK	8	2500	Green (RoHS & no Sb/Br)	CU NIPDAU	Level-2-260C-1 YEAR
REG113EA-3.3/250	ACTIVE	MSOP	DGK	8	250	Green (RoHS & no Sb/Br)	CU NIPDAU	Level-2-260C-1 YEAR
REG113EA-3.3/2K5	ACTIVE	MSOP	DGK	8	2500	Green (RoHS & no Sb/Br)	CU NIPDAU	Level-2-260C-1 YEAR
REG113EA-3/250	ACTIVE	MSOP	DGK	8	250	Green (RoHS & no Sb/Br)	CU NIPDAU	Level-2-260C-1 YEAR
REG113EA-3/2K5	ACTIVE	MSOP	DGK	8	2500	Green (RoHS & no Sb/Br)	CU NIPDAU	Level-2-260C-1 YEAR
REG113EA-3/2K5G4	ACTIVE	MSOP	DGK	8	2500	Green (RoHS & no Sb/Br)	CU NIPDAU	Level-2-260C-1 YEAR
REG113EA-5/250	ACTIVE	MSOP	DGK	8	250	Green (RoHS & no Sb/Br)	CU NIPDAU	Level-2-260C-1 YEAR
REG113EA-5/250G4	ACTIVE	MSOP	DGK	8	250	Green (RoHS & no Sb/Br)	CU NIPDAU	Level-2-260C-1 YEAR
REG113EA-5/2K5	ACTIVE	MSOP	DGK	8	2500	Green (RoHS & no Sb/Br)	CU NIPDAU	Level-2-260C-1 YEAR
REG113EA-5/2K5G4	ACTIVE	MSOP	DGK	8	2500	Green (RoHS & no Sb/Br)	CU NIPDAU	Level-2-260C-1 YEAR
REG113EA285250G4	ACTIVE	MSOP	DGK	8	250	Green (RoHS & no Sb/Br)	CU NIPDAU	Level-2-260C-1 YEAR
REG113EA2852K5G4	ACTIVE	MSOP	DGK	8	2500	Green (RoHS & no Sb/Br)	CU NIPDAU	Level-2-260C-1 YEAR
REG113EA33250G4	ACTIVE	MSOP	DGK	8	250	Green (RoHS & no Sb/Br)	CU NIPDAU	Level-2-260C-1 YEAR
REG113EA332K5G4	ACTIVE	MSOP	DGK	8	2500	Green (RoHS & no Sb/Br)	CU NIPDAU	Level-2-260C-1 YEAR
REG113NA-2.5/250	ACTIVE	SOT-23	DBV	5	250	Green (RoHS & no Sb/Br)	CU NIPDAU	Level-1-260C-UNLIM
REG113NA-2.5/250G4	ACTIVE	SOT-23	DBV	5	250	Green (RoHS & no Sb/Br)	CU NIPDAU	Level-1-260C-UNLIM
REG113NA-2.5/3K	ACTIVE	SOT-23	DBV	5	3000	Green (RoHS & no Sb/Br)	CU NIPDAU	Level-1-260C-UNLIM
REG113NA-2.5/3KG4	ACTIVE	SOT-23	DBV	5	3000	Green (RoHS & no Sb/Br)	CU NIPDAU	Level-1-260C-UNLIM
REG113NA-2.85/250	ACTIVE	SOT-23	DBV	5	250	Green (RoHS & no Sb/Br)	CU NIPDAU	Level-1-260C-UNLIM
REG113NA-2.85/3K	ACTIVE	SOT-23	DBV	5	3000	Green (RoHS & no Sb/Br)	CU NIPDAU	Level-1-260C-UNLIM
REG113NA-2.85/3KG4	ACTIVE	SOT-23	DBV	5	3000	Green (RoHS & no Sb/Br)	CU NIPDAU	Level-1-260C-UNLIM
REG113NA-3.3/250	ACTIVE	SOT-23	DBV	5	250	Green (RoHS & no Sb/Br)	CU NIPDAU	Level-1-260C-UNLIM

Orderable Device	Status <sup>(1)</sup>	Package Type	Package Drawing	Pins	Package Qty	Eco Plan <sup>(2)</sup>	Lead/Ball Finish	MSL Peak Temp <sup>(3)</sup>
REG113NA-3.3/250G4	ACTIVE	SOT-23	DBV	5	250	Green (RoHS & no Sb/Br)	CU NIPDAU	Level-1-260C-UNLIM
REG113NA-3.3/3K	ACTIVE	SOT-23	DBV	5	3000	Green (RoHS & no Sb/Br)	CU NIPDAU	Level-1-260C-UNLIM
REG113NA-3.3/3KG4	ACTIVE	SOT-23	DBV	5	3000	Green (RoHS & no Sb/Br)	CU NIPDAU	Level-1-260C-UNLIM
REG113NA-3/250	ACTIVE	SOT-23	DBV	5	250	Green (RoHS & no Sb/Br)	CU NIPDAU	Level-1-260C-UNLIM
REG113NA-3/250G4	ACTIVE	SOT-23	DBV	5	250	Green (RoHS & no Sb/Br)	CU NIPDAU	Level-1-260C-UNLIM
REG113NA-3/3K	ACTIVE	SOT-23	DBV	5	3000	Green (RoHS & no Sb/Br)	CU NIPDAU	Level-1-260C-UNLIM
REG113NA-3/3KG4	ACTIVE	SOT-23	DBV	5	3000	Green (RoHS & no Sb/Br)	CU NIPDAU	Level-1-260C-UNLIM
REG113NA-5/250	ACTIVE	SOT-23	DBV	5	250	Green (RoHS & no Sb/Br)	CU NIPDAU	Level-1-260C-UNLIM
REG113NA-5/3K	ACTIVE	SOT-23	DBV	5	3000	Green (RoHS & no Sb/Br)	CU NIPDAU	Level-1-260C-UNLIM
REG113NA2.85/250G4	ACTIVE	SOT-23	DBV	5	250	Green (RoHS & no Sb/Br)	CU NIPDAU	Level-1-260C-UNLIM

<sup>(1)</sup> The marketing status values are defined as follows:

**ACTIVE:** Product device recommended for new designs.

**LIFEBUY:** TI has announced that the device will be discontinued, and a lifetime-buy period is in effect.

**NRND:** Not recommended for new designs. Device is in production to support existing customers, but TI does not recommend using this part in a new design.

**PREVIEW:** Device has been announced but is not in production. Samples may or may not be available.

**OBsolete:** TI has discontinued the production of the device.

<sup>(2)</sup> Eco Plan - The planned eco-friendly classification: Pb-Free (RoHS), Pb-Free (RoHS Exempt), or Green (RoHS & no Sb/Br) - please check <http://www.ti.com/productcontent> for the latest availability information and additional product content details.

**TBD:** The Pb-Free/Green conversion plan has not been defined.

**Pb-Free (RoHS):** TI's terms "Lead-Free" or "Pb-Free" mean semiconductor products that are compatible with the current RoHS requirements for all 6 substances, including the requirement that lead not exceed 0.1% by weight in homogeneous materials. Where designed to be soldered at high temperatures, TI Pb-Free products are suitable for use in specified lead-free processes.

**Pb-Free (RoHS Exempt):** This component has a RoHS exemption for either 1) lead-based flip-chip solder bumps used between the die and package, or 2) lead-based die adhesive used between the die and leadframe. The component is otherwise considered Pb-Free (RoHS compatible) as defined above.

**Green (RoHS & no Sb/Br):** TI defines "Green" to mean Pb-Free (RoHS compatible), and free of Bromine (Br) and Antimony (Sb) based flame retardants (Br or Sb do not exceed 0.1% by weight in homogeneous material)

<sup>(3)</sup> MSL, Peak Temp. -- The Moisture Sensitivity Level rating according to the JEDEC industry standard classifications, and peak solder temperature.

**Important Information and Disclaimer:**The information provided on this page represents TI's knowledge and belief as of the date that it is provided. TI bases its knowledge and belief on information provided by third parties, and makes no representation or warranty as to the accuracy of such information. Efforts are underway to better integrate information from third parties. TI has taken and continues to take reasonable steps to provide representative and accurate information but may not have conducted destructive testing or chemical analysis on incoming materials and chemicals. TI and TI suppliers consider certain information to be proprietary, and thus CAS numbers and other limited information may not be available for release.

In no event shall TI's liability arising out of such information exceed the total purchase price of the TI part(s) at issue in this document sold by TI to Customer on an annual basis.

# MECHANICAL DATA

DBV (R-PDSO-G5)

PLASTIC SMALL-OUTLINE PACKAGE

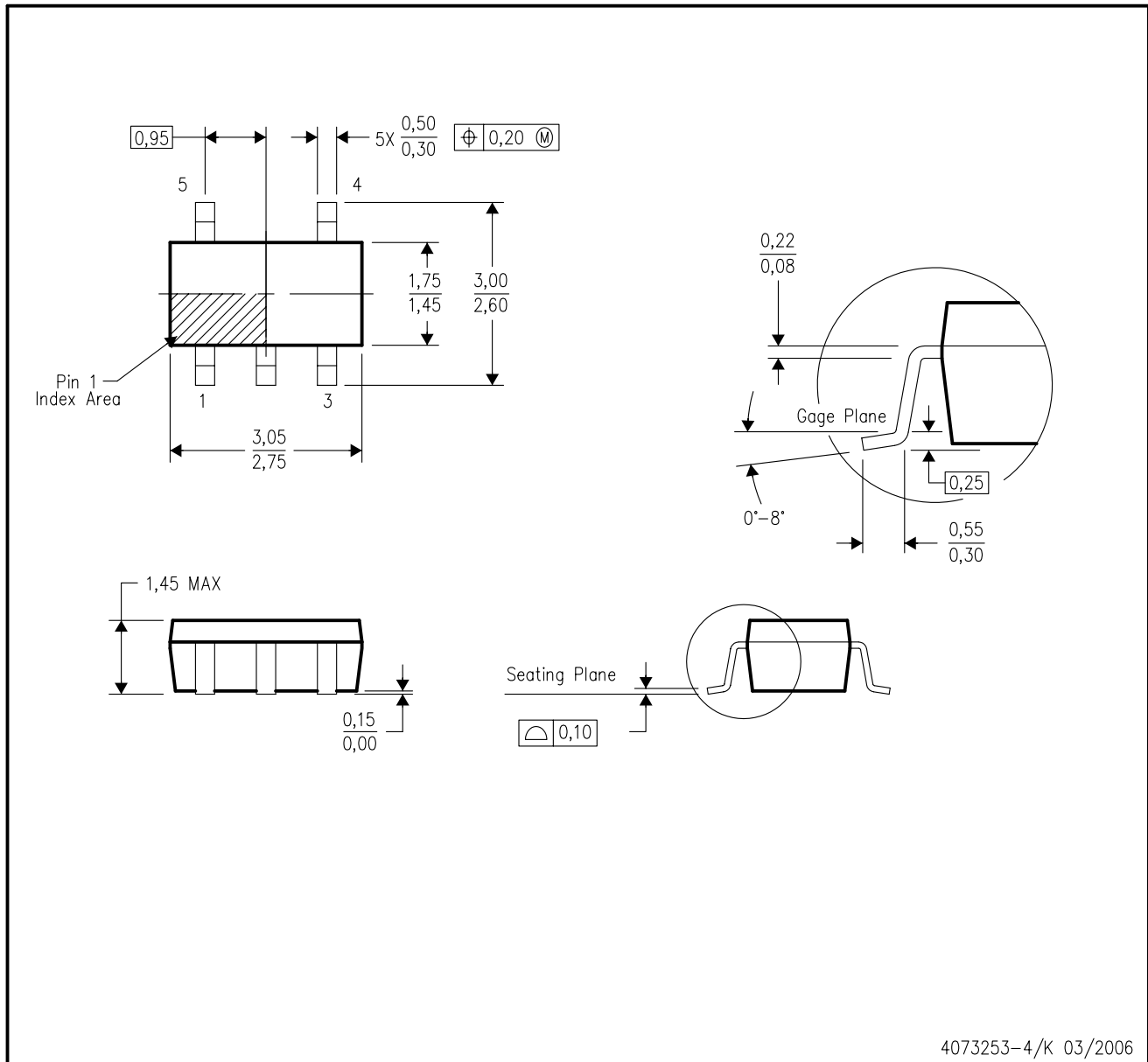

- NOTES:
- All linear dimensions are in millimeters.
  - This drawing is subject to change without notice.
  - Body dimensions do not include mold flash or protrusion. Mold flash and protrusion shall not exceed 0.15 per side.
  - Falls within JEDEC MO-178 Variation AA.

# MECHANICAL DATA

DGK (S-PDSO-G8)

PLASTIC SMALL-OUTLINE PACKAGE

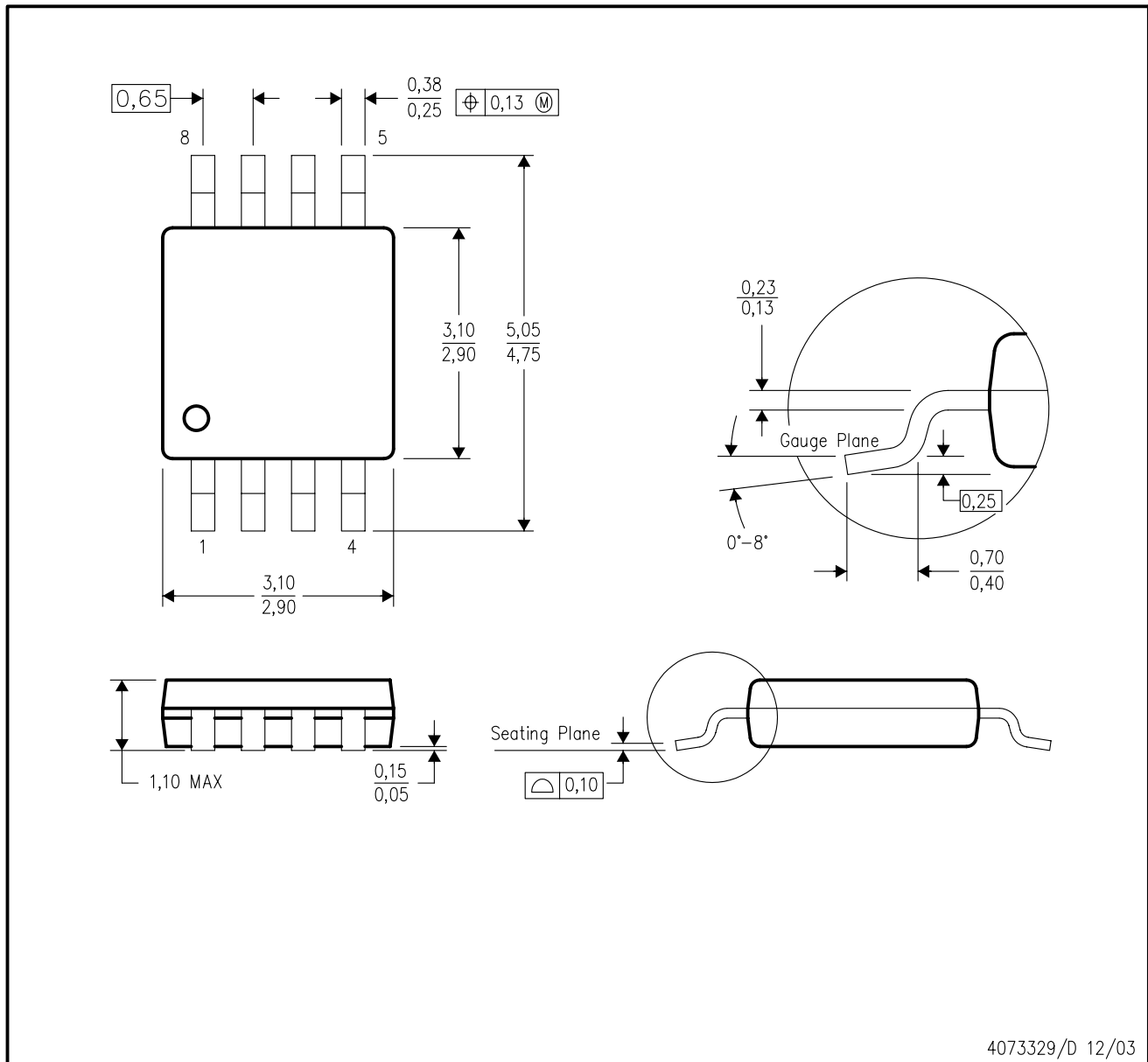

- NOTES:
- All linear dimensions are in millimeters.
  - This drawing is subject to change without notice.
  - Body dimensions do not include mold flash or protrusion.
  - Falls within JEDEC MO-187 variation AA.

## IMPORTANT NOTICE

Texas Instruments Incorporated and its subsidiaries (TI) reserve the right to make corrections, modifications, enhancements, improvements, and other changes to its products and services at any time and to discontinue any product or service without notice. Customers should obtain the latest relevant information before placing orders and should verify that such information is current and complete. All products are sold subject to TI's terms and conditions of sale supplied at the time of order acknowledgment.

TI warrants performance of its hardware products to the specifications applicable at the time of sale in accordance with TI's standard warranty. Testing and other quality control techniques are used to the extent TI deems necessary to support this warranty. Except where mandated by government requirements, testing of all parameters of each product is not necessarily performed.

TI assumes no liability for applications assistance or customer product design. Customers are responsible for their products and applications using TI components. To minimize the risks associated with customer products and applications, customers should provide adequate design and operating safeguards.

TI does not warrant or represent that any license, either express or implied, is granted under any TI patent right, copyright, mask work right, or other TI intellectual property right relating to any combination, machine, or process in which TI products or services are used. Information published by TI regarding third-party products or services does not constitute a license from TI to use such products or services or a warranty or endorsement thereof. Use of such information may require a license from a third party under the patents or other intellectual property of the third party, or a license from TI under the patents or other intellectual property of TI.

Reproduction of information in TI data books or data sheets is permissible only if reproduction is without alteration and is accompanied by all associated warranties, conditions, limitations, and notices. Reproduction of this information with alteration is an unfair and deceptive business practice. TI is not responsible or liable for such altered documentation.

Resale of TI products or services with statements different from or beyond the parameters stated by TI for that product or service voids all express and any implied warranties for the associated TI product or service and is an unfair and deceptive business practice. TI is not responsible or liable for any such statements.

Following are URLs where you can obtain information on other Texas Instruments products and application solutions:

<b>Products</b>		<b>Applications</b>	
Amplifiers	<a href="http://amplifier.ti.com">amplifier.ti.com</a>	Audio	<a href="http://www.ti.com/audio">www.ti.com/audio</a>
Data Converters	<a href="http://dataconverter.ti.com">dataconverter.ti.com</a>	Automotive	<a href="http://www.ti.com/automotive">www.ti.com/automotive</a>
DSP	<a href="http://dsp.ti.com">dsp.ti.com</a>	Broadband	<a href="http://www.ti.com/broadband">www.ti.com/broadband</a>
Interface	<a href="http://interface.ti.com">interface.ti.com</a>	Digital Control	<a href="http://www.ti.com/digitalcontrol">www.ti.com/digitalcontrol</a>
Logic	<a href="http://logic.ti.com">logic.ti.com</a>	Military	<a href="http://www.ti.com/military">www.ti.com/military</a>
Power Mgmt	<a href="http://power.ti.com">power.ti.com</a>	Optical Networking	<a href="http://www.ti.com/opticalnetwork">www.ti.com/opticalnetwork</a>
Microcontrollers	<a href="http://microcontroller.ti.com">microcontroller.ti.com</a>	Security	<a href="http://www.ti.com/security">www.ti.com/security</a>
		Telephony	<a href="http://www.ti.com/telephony">www.ti.com/telephony</a>
		Video & Imaging	<a href="http://www.ti.com/video">www.ti.com/video</a>
		Wireless	<a href="http://www.ti.com/wireless">www.ti.com/wireless</a>

Mailing Address: Texas Instruments  
Post Office Box 655303 Dallas, Texas 75265