

## Micro-Power Voltage Detectors

### General Description

The RT9818 is a micro-power voltage detector supervising the power supply voltage level for microprocessors ( $\mu$ P) or digital systems. It provides internally fixed threshold levels with 0.1V per step ranging from 1.2V to 5V, which covers most digital applications. It features low supply current of 3 $\mu$ A. The RT9818 performs supervisory function by sending out a reset signal whenever the  $V_{DD}$  voltage falls below a preset threshold level. This reset signal will last the whole period before  $V_{DD}$  recovering. Once  $V_{DD}$  recovered upcrossing the threshold level, the reset signal will be released after a certain delay time. RT9818 is provided in SC-70-3, SC-70-4, SOT-23-3, SOT-23-5 and SOT-89 packages.

### Applications

- Computers
- Controllers
- Intelligent Instruments
- Critical  $\mu$ P and  $\mu$ C Power Monitoring
- Portable/Battery-Powered Equipment

### Marking Information

For marking information, contact our sales representative directly or through a RichTek distributor located in your area, otherwise visit our website for detail.

### Typical Application Circuit

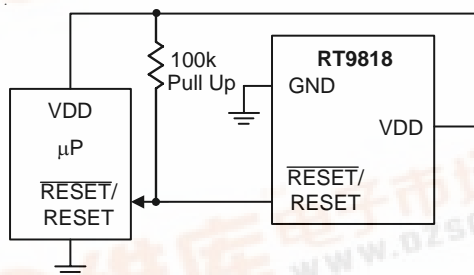

### Features

- Internally Fixed Threshold 1.2V to 5V in 0.1V Step
- High Accuracy  $\pm 1.5\%$
- Low Supply Current 3 $\mu$ A
- No External Components Required
- Quick Reset within 20 $\mu$ s
- Built-in Recovery Delay Include 0ms, 55ms, 220ms, 450ms Options
- Low Functional Supply Voltage 0.9V
- N-Channel Open-Drain Output
- Small SC-70-3, SC-70-4, SOT-23-3, SOT-23-5, SOT-89 Packages
- RoHS Compliant and 100% Lead (Pb)-Free

### Ordering Information

RT9818□-□□□□

Package Type

U3 : SC-70-3

U4 : SC-70-4

U4R : SC-70-4 (R-Type)

V : SOT-23-3

VL : SOT-23-3 (L-Type)

B : SOT-23-5

X : SOT-89

Operating Temperature Range

C : Commercial Standard

P : Pb Free with Commercial Standard

Threshold Voltage

12 : 1.2V

13 : 1.3V

:

49 : 4.9V

50 : 5.0V

Reset Active Timeout Period

A = 0ms (RESET)

B = 55ms (RESET)

C = 220ms (RESET)

D = 450ms (RESET)

E = 0ms (RESET)

F = 55ms (RESET)

G = 220ms (RESET)

H = 450ms (RESET)

Note :

RichTek Pb-free products are :

- RoHS compliant and compatible with the current requirements of IPC/JEDEC J-STD-020.
- Suitable for use in SnPb or Pb-free soldering processes.
- 100%matte tin (Sn) plating.



Pin Configurations

(TOP VIEW)

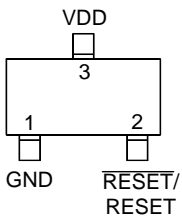

SC-70-3

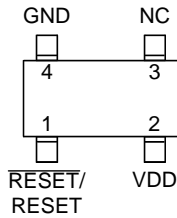

SC-70-4

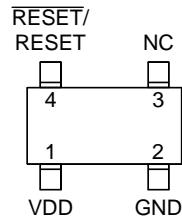

SC-70-4 (R-Type)

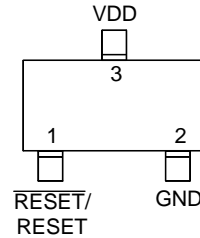

SOT-23-3

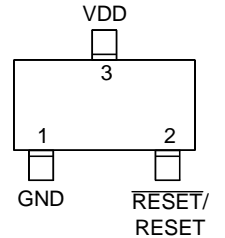

SOT-23-3 (L-Type)

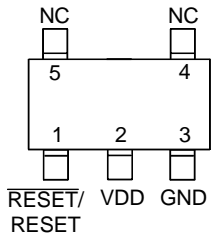

SOT-23-5

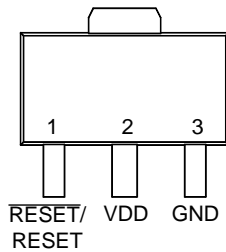

SOT-89

Functional Pin Description

Pin Name	Pin Function
GND	Ground
$\overline{\text{RESET}}$	Active Low Open-Drain Reset Output
RESET	Active High Open-Drain Reset Output
VDD	Power Pin

Function Block Diagram

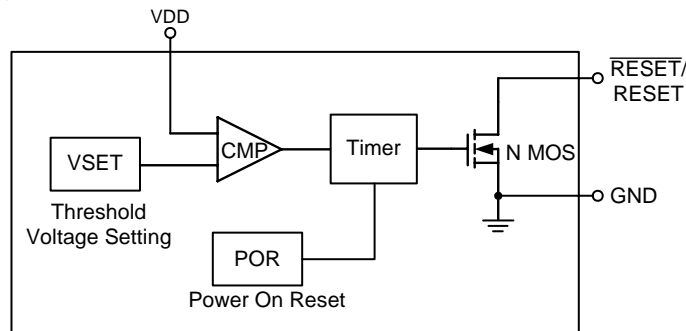

**Absolute Maximum Ratings** (Note 1)

- Terminal Voltage (with Respect to GND)
  - $V_{DD}$  ----- -0.3V to 6.0V
- All Other Inputs ----- -0.3V to  $V_{DD}+0.3V$
- Input Current,  $I_{VDD}$  ----- 20mA
- Power Dissipation,  $P_D$  @  $T_A = 25^\circ C$ 
  - SC-70 ----- 0.25W
  - SOT-23-3 ----- 0.4W
  - SOT-23-5 ----- 0.4W
  - SOT-89 ----- 0.55W
- Package Thermal Resistance (Note 4)
  - SC-70,  $\theta_{JA}$  ----- 400°C/W
  - SOT-23-3,  $\theta_{JA}$  ----- 250°C/W
  - SOT-23-5,  $\theta_{JA}$  ----- 250°C/W
  - SOT-89,  $\theta_{JA}$  ----- 180°C/W
- Lead Temperature (Soldering, 10sec.) ----- 260°C
- Storage Temperature Range ----- -65°C to 125°C
- ESD Susceptibility (Note 2)
  - HBM (Human Body Mode) ----- 2kV
  - MM (Machine Mode) ----- 200V

**Recommended Operating Conditions** (Note 3)

- Junction Temperature Range ----- -40°C to 125°C

**Electrical Characteristics**

( $V_{DD} = 3V$ , unless otherwise specified)

Parameter	Symbol	Test Conditions	Min	Typ	Max	Units
Operating $V_{DD}$ ( $V_{OUT}$ ) Range	$V_{DD}$		0.9	--	6	V
Supply Current	$I_{DD}$	$V_{TH} = 3V, V_{DD} = 4.5V, T_A = 27^\circ C$	--	3	--	$\mu A$
Reset Threshold	$V_{TH}$	$T_A = 27^\circ C$	--	1.2 to 5.0	--	V
Threshold Voltage Accuracy	$\Delta V_{TH}$	$T_A = 27^\circ C$	-1.5	--	+1.5	%
$V_{DD}$ Drop to Reset Delay	$t_{RD}$	Drop = $V_{TH} - 125mV$	--	20	--	$\mu s$
Reset Active Time Out Period	RT9818A/E	$V_{DD} \geq 1.02 \times V_{TH}$	--	0	--	ms
	RT9818B/F		--	55	--	
	RT9818C/G		--	220	--	
	RT9818D/H		--	450	--	
RESET Output Voltage Low	$V_{OL}$	$3 = V_{DD} < V_{TH}, I_{SINK} > 3.5mA$	--	0.4	--	V
Hysteresis Width	$V_{HYS}$			$0.01V_{TH}$		V

- Note 1.** Stresses listed as the above "Absolute Maximum Ratings" may cause permanent damage to the device. These are for stress ratings. Functional operation of the device at these or any other conditions beyond those indicated in the operational sections of the specifications is not implied. Exposure to absolute maximum rating conditions for extended periods may remain possibility to affect device reliability.
- Note 2.** Devices are ESD sensitive. Handling precaution recommended.
- Note 3.** The device is not guaranteed to function outside its operating conditions.
- Note 4.**  $\theta_{JA}$  is measured in the natural convection at  $T_A = 25^\circ\text{C}$  on a low effective thermal conductivity test board of JEDEC 51-3 thermal measurement standard.

**Typical Operating Characteristics**

**Nch Driver Output Current vs.  $V_{DS}$**

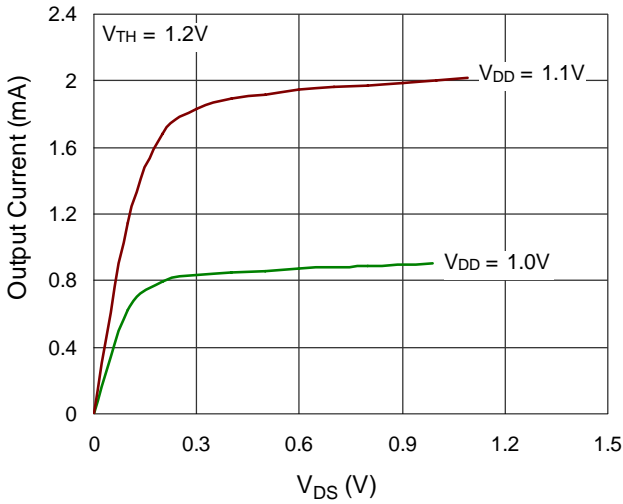

**Nch Driver Output Current vs.  $V_{DS}$**

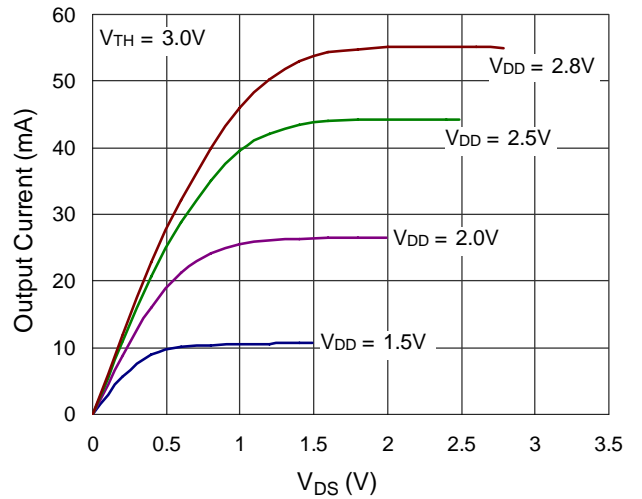

**Nch Driver Output Current vs.  $V_{DS}$**

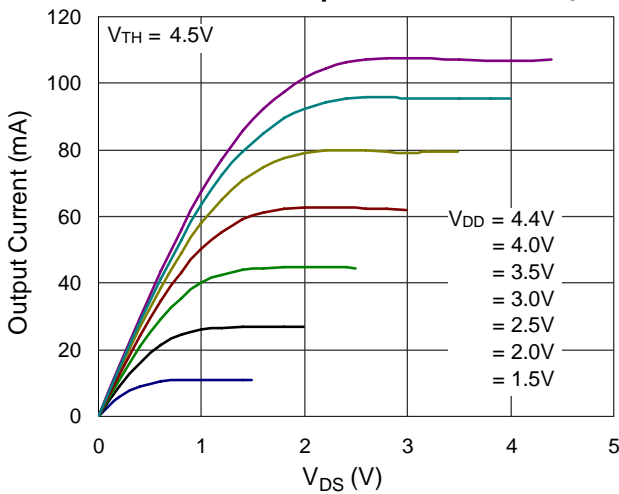

**Output Voltage vs. Input Voltage**

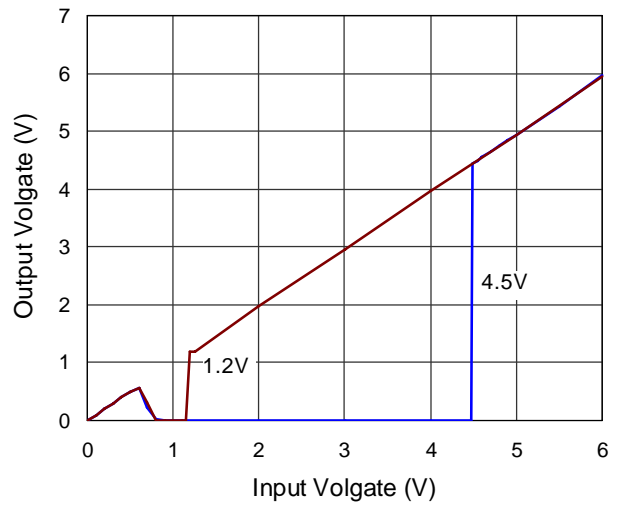

**Supply Current vs. Input Voltage**

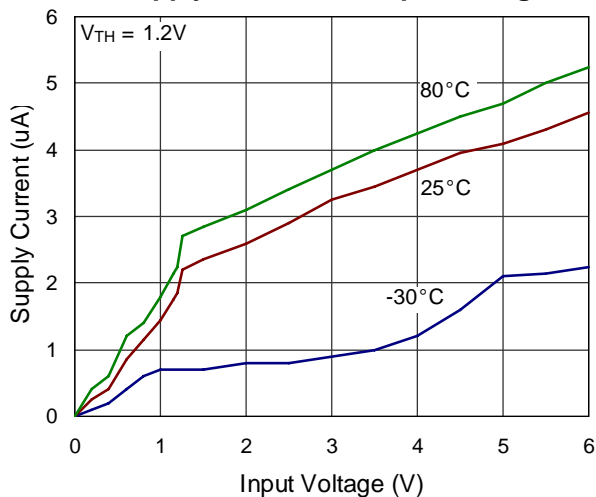

**Supply Current vs. Input Voltage**

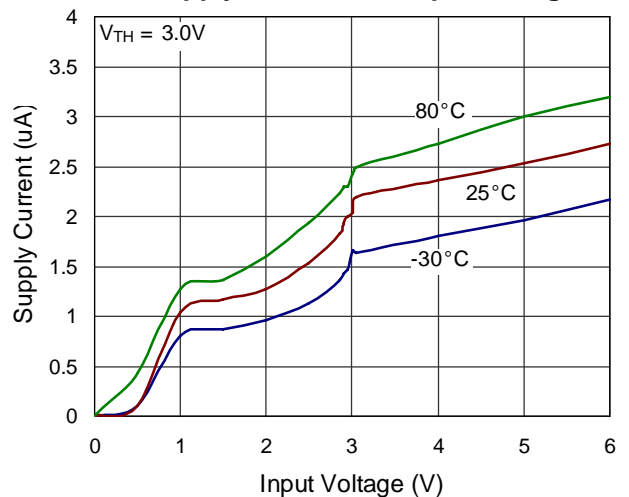

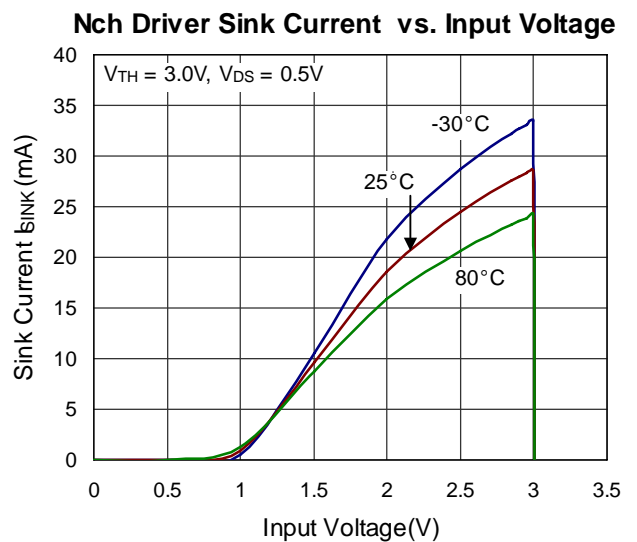
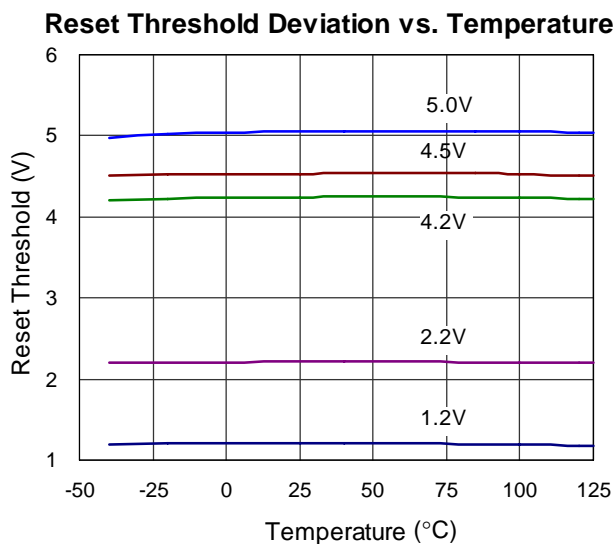
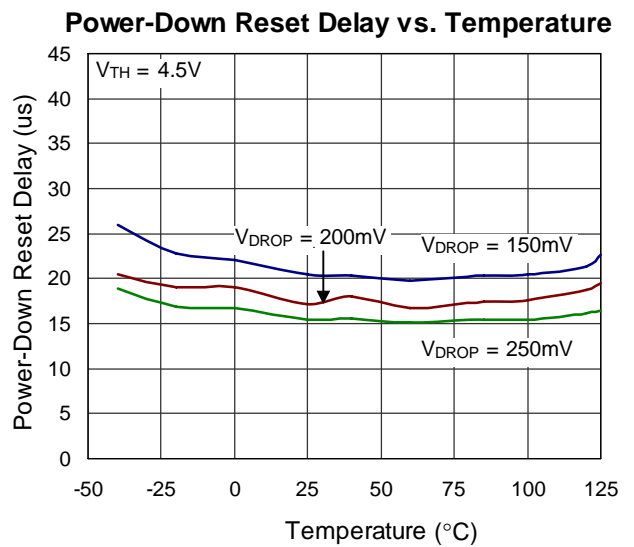
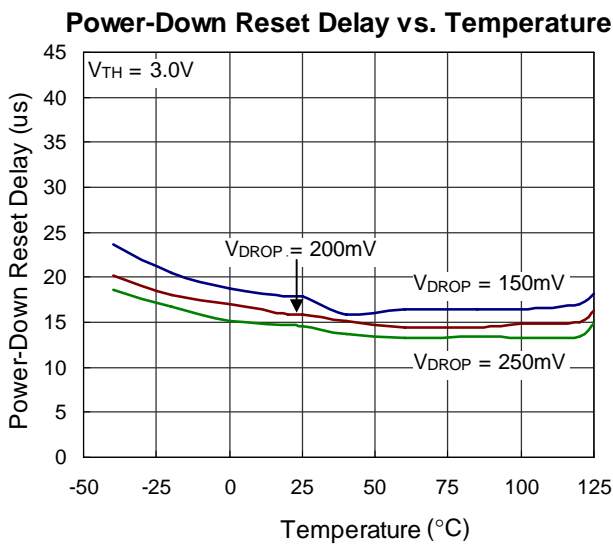
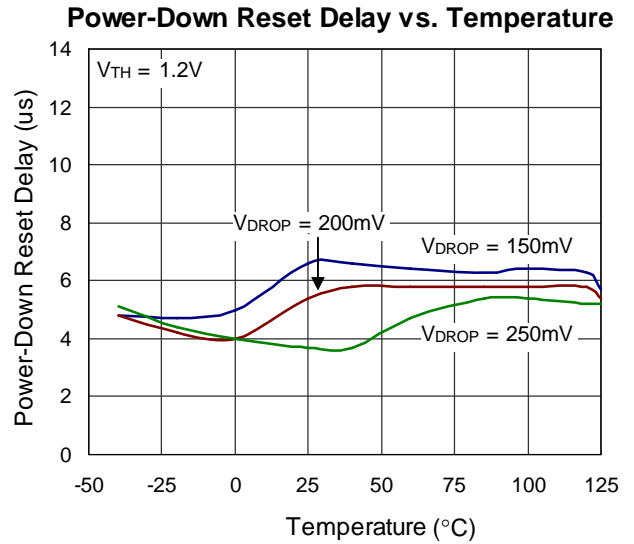
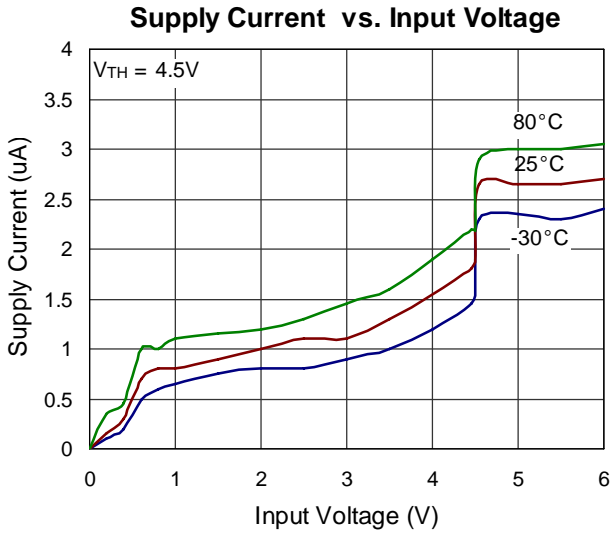

Nch Driver Sink Current vs. Input Voltage

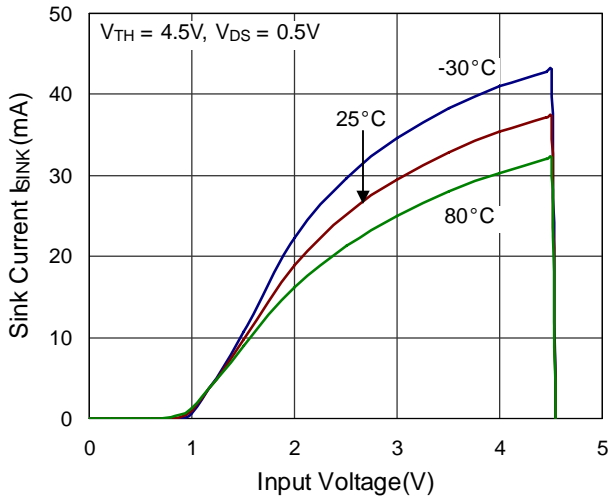

Power-Up Reset Time-Out vs. Temperature

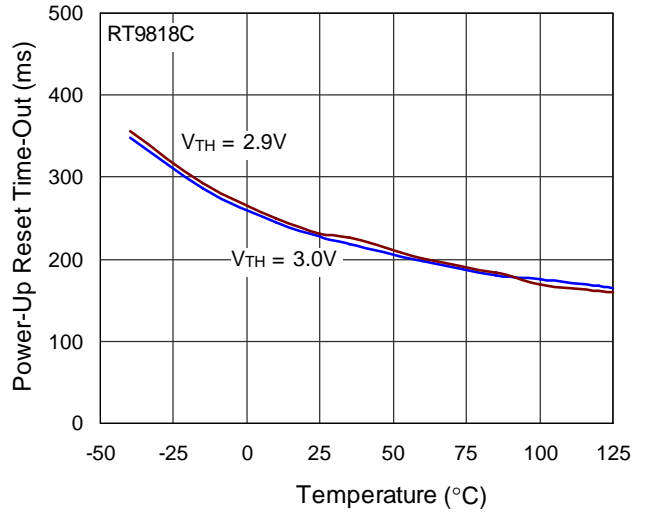

Power-Up Reset Time-Out vs. Temperature

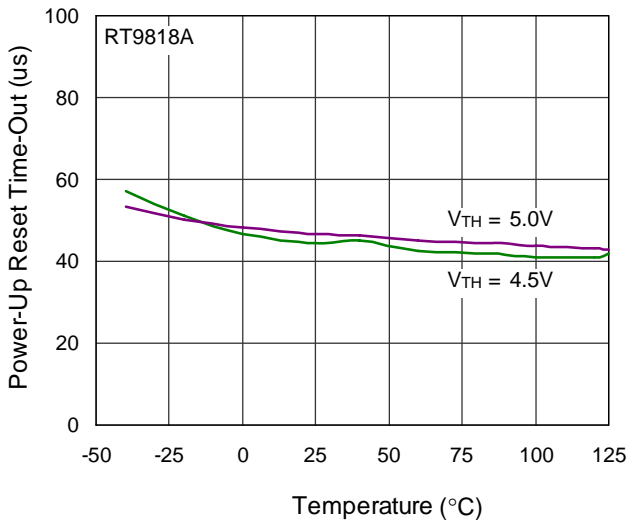

Output Delay Time vs. Load Capacitance

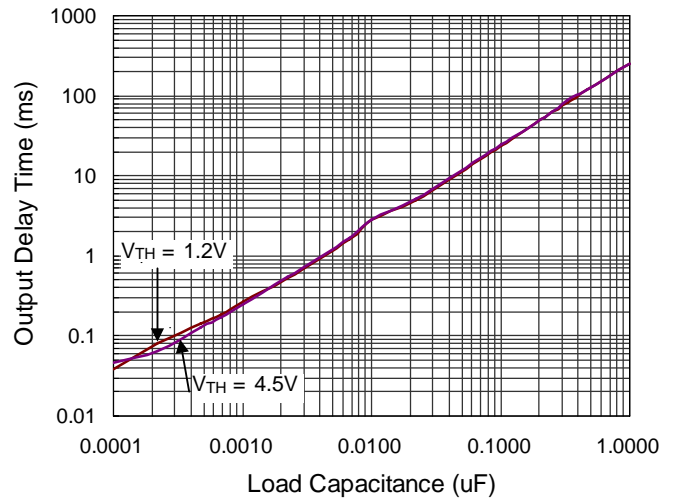

Nch Driver Output Current vs.  $V_{DS}$

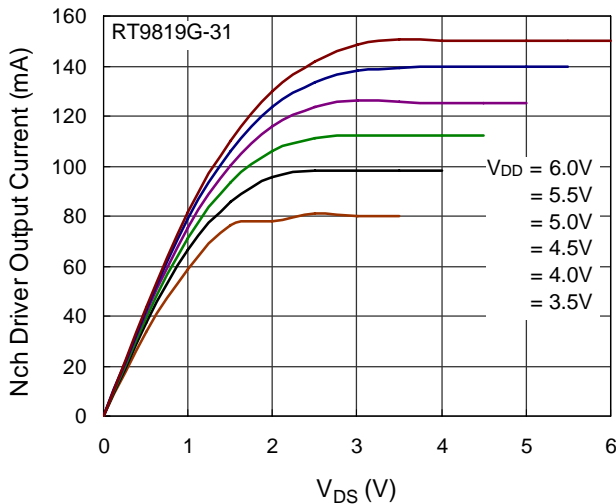

Nch Driver Output Current vs. Input Voltage

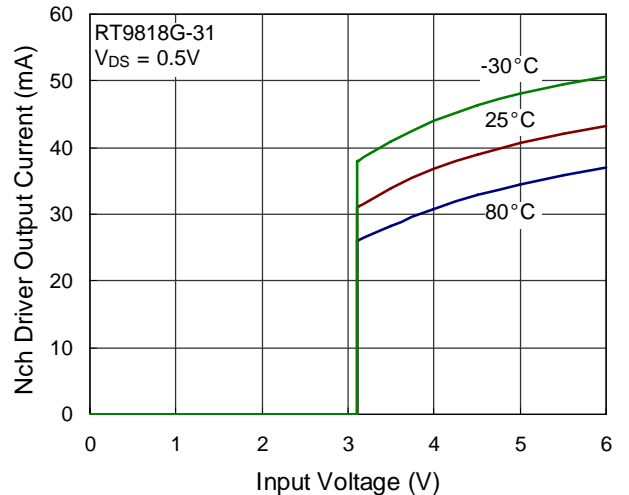

Power Down Reset Time-Out vs. Temperature

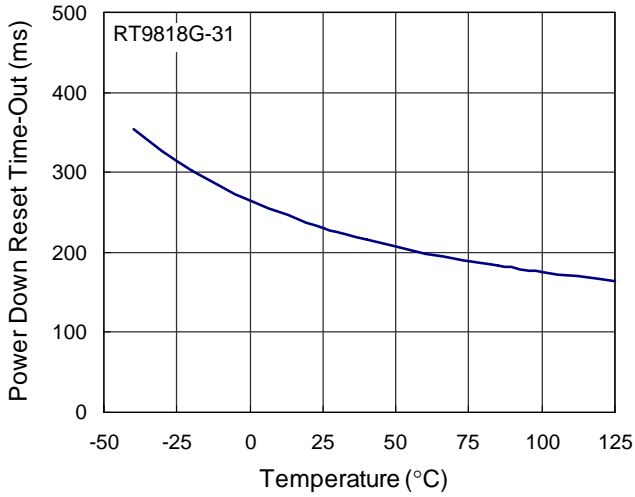

Output Voltage vs. Input Voltage

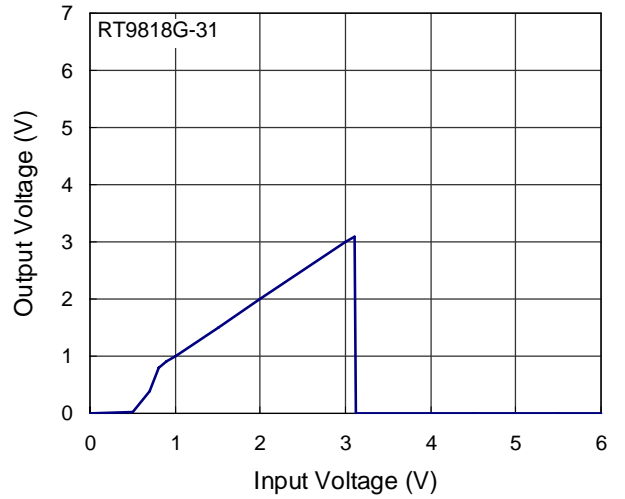

Power-Down Reset Time-Out vs. Temperature

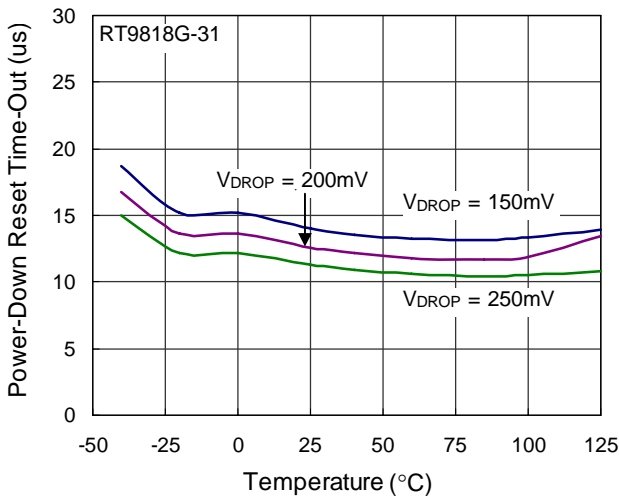



## **Application Information**

### **Multiple Supplies**

Mainly, the pull-up connected to the RT9818 will connect to the supply voltage that is being monitored at the IC's VDD pin. However, some systems may use the open-drain output to level-shift from the monitored supply to reset circuitry powered by some other supply.

### **Benefits of Highly Accurate Reset Threshold**

Most  $\mu$ P supervisor ICs have reset threshold voltages between 1% and 1.5% below the value of nominal supply voltages. This ensures a reset will not occur within 1% of the nominal supply, but will occur when the supply is 1.5% below nominal.

Outline Dimension

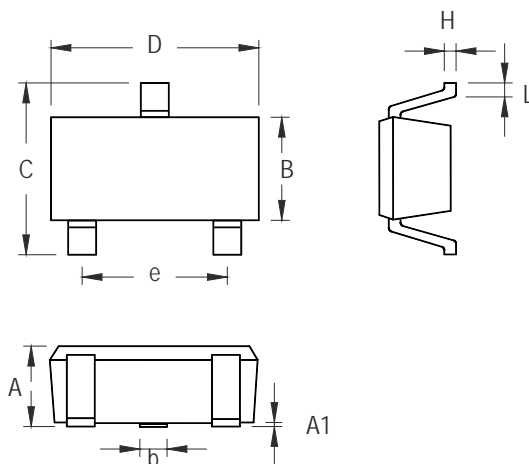

Symbol	Dimensions In Millimeters		Dimensions In Inches	
	Min	Max	Min	Max
A	0.800	1.100	0.031	0.044
A1	0.000	0.100	0.000	0.004
B	1.150	1.350	0.045	0.054
b	0.150	0.400	0.006	0.016
C	1.800	2.450	0.071	0.096
D	1.800	2.250	0.071	0.089
e	1.300		0.051	
H	0.080	0.260	0.003	0.010
L	0.210	0.460	0.008	0.018

SC-70-3 Surface Mount Package

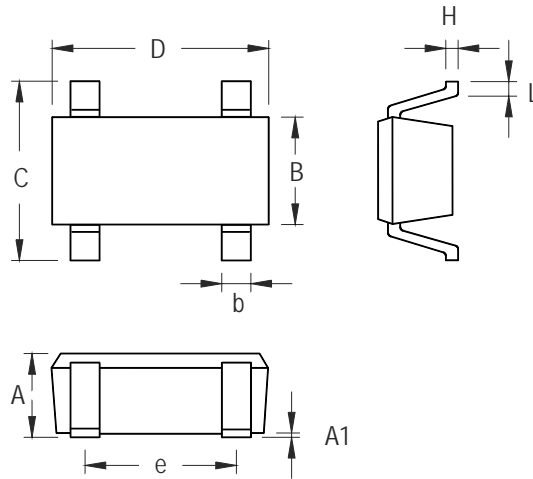

Symbol	Dimensions In Millimeters		Dimensions In Inches	
	Min	Max	Min	Max
A	0.800	1.100	0.031	0.043
A1	0.000	0.100	0.000	0.004
B	1.150	1.350	0.045	0.053
b	0.150	0.400	0.006	0.016
C	1.800	2.450	0.071	0.096
D	1.800	2.250	0.071	0.089
e	1.300		0.051	
H	0.080	0.260	0.003	0.010
L	0.210	0.460	0.008	0.018

**SC-70-4 Surface Mount Package**

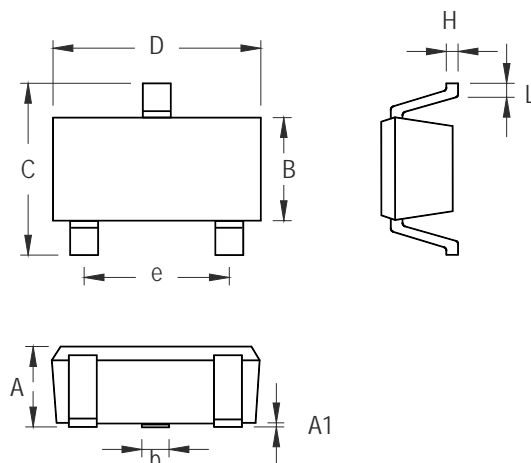

Symbol	Dimensions In Millimeters		Dimensions In Inches	
	Min	Max	Min	Max
A	0.889	1.295	0.035	0.051
A1	0.000	0.152	0.000	0.006
B	1.397	1.803	0.055	0.071
b	0.356	0.508	0.014	0.020
C	2.591	2.997	0.102	0.118
D	2.692	3.099	0.106	0.122
e	1.803	2.007	0.071	0.079
H	0.080	0.254	0.003	0.010
L	0.300	0.610	0.012	0.024

SOT-23-3 Surface Mount Package

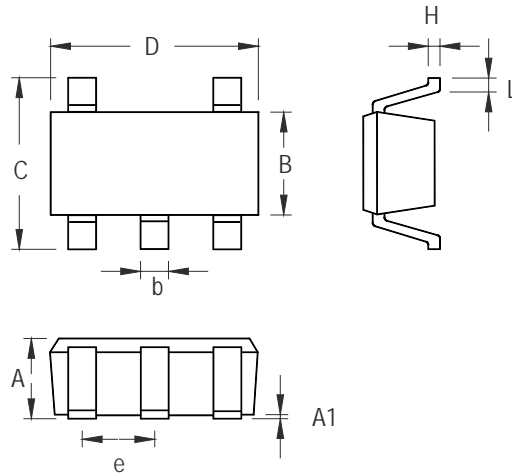

Symbol	Dimensions In Millimeters		Dimensions In Inches	
	Min	Max	Min	Max
A	0.889	1.295	0.035	0.051
A1	0.000	0.152	0.000	0.006
B	1.397	1.803	0.055	0.071
b	0.356	0.559	0.014	0.022
C	2.591	2.997	0.102	0.118
D	2.692	3.099	0.106	0.122
e	0.838	1.041	0.033	0.041
H	0.080	0.254	0.003	0.010
L	0.300	0.610	0.012	0.024

**SOT-23-5 Surface Mount Package**

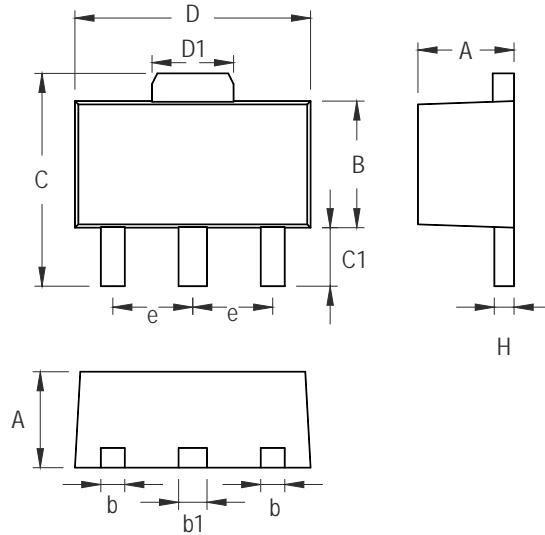

Symbol	Dimensions In Millimeters		Dimensions In Inches	
	Min	Max	Min	Max
A	1.397	1.600	0.055	0.063
b	0.356	0.483	0.014	0.019
B	2.388	2.591	0.094	0.102
b1	0.406	0.533	0.016	0.021
C	3.937	4.242	0.155	0.167
C1	0.787	1.194	0.031	0.047
D	4.394	4.597	0.173	0.181
D1	1.397	1.753	0.055	0.069
e	1.448	1.549	0.057	0.061
H	0.356	0.432	0.014	0.017

**3-Lead SOT-89 Surface Mount Package**

**RICHTEK TECHNOLOGY CORP.**

Headquarter  
 5F, No. 20, Taiyuen Street, Chupei City  
 Hsinchu, Taiwan, R.O.C.  
 Tel: (8863)5526789 Fax: (8863)5526611

**RICHTEK TECHNOLOGY CORP.**

Taipei Office (Marketing)  
 8F-1, No. 137, Lane 235, Paochiao Road, Hsintien City  
 Taipei County, Taiwan, R.O.C.  
 Tel: (8862)89191466 Fax: (8862)89191465  
 Email: marketing@richtek.com