

MGP19N35CL, MGB19N35CL

Preferred Device

Ignition IGBT 19 Amps, 350 Volts N-Channel TO-220 and D²PAK

This Logic Level Insulated Gate Bipolar Transistor (IGBT) features monolithic circuitry integrating ESD and Over-Voltage clamped protection for use in inductive coil drivers applications. Primary uses include Ignition, Direct Fuel Injection, or wherever high voltage and high current switching is required.

- Ideal for IGBT-On-Coil or Distributorless Ignition System Applications
- High Pulsed Current Capability up to 50 A
- Gate-Emitter ESD Protection
- Temperature Compensated Gate-Collector Voltage Clamp Limits Stress Applied to Load
- Integrated ESD Diode Protection
- Low Threshold Voltage to Interface Power Loads to Logic or Microprocessor Devices
- Low Saturation Voltage
- Optional Gate Resistor (R_{GE})

MAXIMUM RATINGS (-55°C ≤ T_J ≤ 175°C unless otherwise noted)

Rating	Symbol	Value	Unit
Collector-Emitter Voltage	V _{CES}	380	V _{DC}
Collector-Gate Voltage	V _{CER}	380	V _{DC}
Gate-Emitter Voltage	V _{GE}	22	V _{DC}
Collector Current - Continuous @ T _C = 25°C - Pulsed	I _C	19 50	A _{DC} A _{AC}
ESD (Human Body Model) R = 1500 Ω, C = 100 pF	ESD	8.0	kV
ESD (Machine Model) R = 0 Ω, C = 200 pF	ESD	800	V
Total Power Dissipation @ T _C = 25°C Derate above 25°C	P _D	165 1.1	Watts W/°C
Operating and Storage Temperature Range	T _J , T _{stg}	-55 to 175	°C

UNCLAMPED COLLECTOR-TO-EMITTER AVALANCHE CHARACTERISTICS (-55°C ≤ T_J ≤ 175°C)

Characteristic	Symbol	Value	Unit
Single Pulse Collector-to-Emitter Avalanche Energy V _{CC} = 50 V, V _{GE} = 5.0 V, Pk I _L = 22.4 A, L = 2.0 mH, Starting T _J = 25°C V _{CC} = 50 V, V _{GE} = 5.0 V, Pk I _L = 17.4 A, L = 2.0 mH, Starting T _J = 150°C	E _{AS}	500 300	mJ
Reverse Avalanche Energy V _{CC} = 100 V, V _{GE} = 20 V, L = 3.0 mH, Pk I _L = 25.8 A, Starting T _J = 25°C	E _{AS(R)}	1000	mJ



ON Semiconductor™

<http://onsemi.com>

**19 AMPERES
350 VOLTS (Clamped)
V_{CE(on)} @ 10 A = 1.8 V Max**

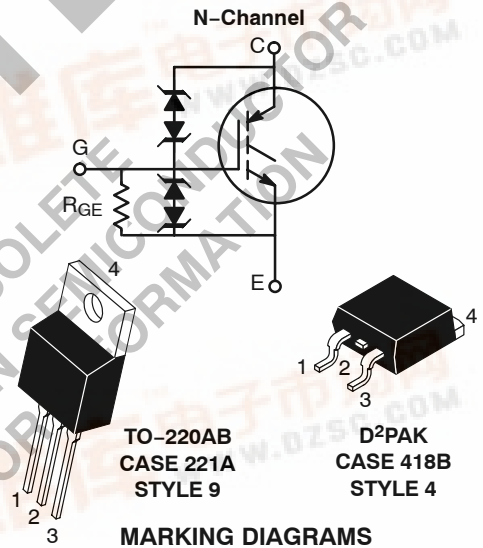

MARKING DIAGRAMS & PIN ASSIGNMENTS

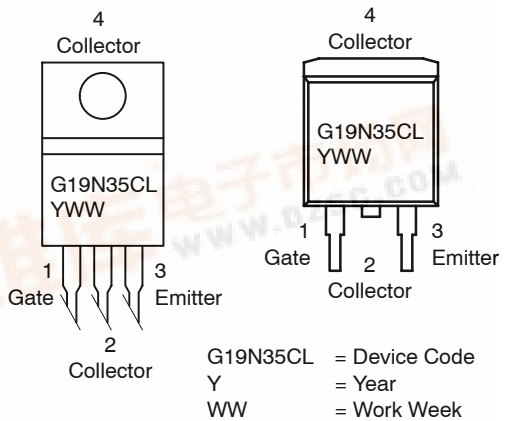

ORDERING INFORMATION

Device	Package	Shipping
MGP19N35CL	TO-220	50 Units/Rail
MGB19N35CLT4	D2PAK	800 Tape & Reel

Preferred devices are recommended choices for future use and best overall value.



MGP19N35CL, MGB19N35CL

Thermal Characteristics

Characteristic	Symbol	Value	Unit
Thermal Resistance, Junction to Case	$R_{\theta JC}$	0.9	°C/W
Thermal Resistance, Junction to Ambient	TO-220 $R_{\theta JA}$	62.5	
	D ² PAK (Note 1.) $R_{\theta JA}$	50	
Maximum Lead Temperature for Soldering Purposes, 1/8" from case for 5 seconds	T_L	275	°C

Electrical Characteristics

Characteristic	Symbol	Test Conditions	Temperature	Min	Typ	Max	Unit
----------------	--------	-----------------	-------------	-----	-----	-----	------

OFF CHARACTERISTICS

Collector-Emitter Clamp Voltage	BV_{CES}	$I_C = 2.0 \text{ mA}$	$T_J = -40^\circ\text{C}$ to 150°C	320	350	380	V_{DC}
		$I_C = 10 \text{ mA}$	$T_J = -40^\circ\text{C}$ to 150°C	330	360	380	
Zero Gate Voltage Collector Current	I_{CES}	$V_{CE} = 300 \text{ V},$ $V_{GE} = 0 \text{ V}$	$T_J = 25^\circ\text{C}$	-	1.5	20	μA_{DC}
			$T_J = 150^\circ\text{C}$	-	15	40*	
			$T_J = -40^\circ\text{C}$	-	0.7	1.5	
Reverse Collector-Emitter Leakage Current	I_{ECS}	$V_{CE} = -24 \text{ V}$	$T_J = 25^\circ\text{C}$	-	0.35	1.0	mA
			$T_J = 150^\circ\text{C}$	-	10	20*	
			$T_J = -40^\circ\text{C}$	-	0.05	0.5	
Reverse Collector-Emitter Clamp Voltage	$BV_{CES(R)}$	$I_C = -75 \text{ mA}$	$T_J = 25^\circ\text{C}$	25	33	50	V_{DC}
			$T_J = 150^\circ\text{C}$	25	36	50	
			$T_J = -40^\circ\text{C}$	25	30	50	
Gate-Emitter Clamp Voltage	BV_{GES}	$I_G = 5.0 \text{ mA}$	$T_J = -40^\circ\text{C}$ to 150°C	17	20	22	V_{DC}
Gate-Emitter Leakage Current	I_{GES}	$V_{GE} = 10 \text{ V}$	$T_J = -40^\circ\text{C}$ to 150°C	384	500	1000	μA_{DC}
Gate Resistor (Optional)	R_G	-	$T_J = -40^\circ\text{C}$ to 150°C	-	70	-	Ω
Gate Emitter Resistor	R_{GE}	-	$T_J = -40^\circ\text{C}$ to 150°C	10	20	26	k Ω

ON CHARACTERISTICS (Note 2.)

Gate Threshold Voltage	$V_{GE(th)}$	$I_C = 1.0 \text{ mA},$ $V_{GE} = V_{CE}$	$T_J = 25^\circ\text{C}$	1.4	1.7	2.0	V_{DC}
			$T_J = 150^\circ\text{C}$	0.75	1.1	1.4	
			$T_J = -40^\circ\text{C}$	1.6	1.9	2.1*	
Threshold Temperature Coefficient (Negative)	-	-	-	-	4.4	-	mV/°C

1. When surface mounted to an FR4 board using the minimum recommended pad size.

2. Pulse Test: Pulse Width $\leq 300 \mu\text{s}$, Duty Cycle $\leq 2\%$.

*Maximum Value of Characteristic across Temperature Range.

MGP19N35CL, MGB19N35CL

ELECTRICAL CHARACTERISTICS (continued)

Characteristic	Symbol	Test Conditions	Temperature	Min	Typ	Max	Unit
----------------	--------	-----------------	-------------	-----	-----	-----	------

ON CHARACTERISTICS (continued) (Note 3.)

Collector-to-Emitter On-Voltage	$V_{CE(on)}$	$I_C = 6.0 \text{ A}$, $V_{GE} = 4.0 \text{ V}$	$T_J = 25^\circ\text{C}$	1.0	1.25	1.6	V_{DC}
			$T_J = 150^\circ\text{C}$	0.8	1.05	1.4	
			$T_J = -40^\circ\text{C}$	1.15	1.4	1.75*	
		$I_C = 10 \text{ A}$, $V_{GE} = 4.0 \text{ V}$	$T_J = 25^\circ\text{C}$	1.2	1.5	1.8	
			$T_J = 150^\circ\text{C}$	1.0	1.3	1.6	
			$T_J = -40^\circ\text{C}$	1.3	1.6	1.9*	
		$I_C = 15 \text{ A}$, $V_{GE} = 4.0 \text{ V}$	$T_J = 25^\circ\text{C}$	1.5	1.75	2.1	
			$T_J = 150^\circ\text{C}$	1.35	1.65	1.95	
			$T_J = -40^\circ\text{C}$	1.5	1.8	2.1*	
		$I_C = 20 \text{ A}$, $V_{GE} = 4.0 \text{ V}$	$T_J = 25^\circ\text{C}$	1.7	2.0	2.3	
			$T_J = 150^\circ\text{C}$	1.6	1.9	2.2	
			$T_J = -40^\circ\text{C}$	1.7	2.0	2.3*	
$I_C = 25 \text{ A}$, $V_{GE} = 4.0 \text{ V}$	$T_J = 25^\circ\text{C}$	2.0	2.25	2.6			
	$T_J = 150^\circ\text{C}$	2.0	2.3	2.7*			
	$T_J = -40^\circ\text{C}$	2.0	2.2	2.6			
Collector-to-Emitter On-Voltage	$V_{CE(on)}$	$I_C = 10 \text{ A}$, $V_{GE} = 4.5 \text{ V}$	$T_J = 150^\circ\text{C}$	-	1.3	1.8	V_{DC}
Forward Transconductance	gfs	$V_{CE} = 5.0 \text{ V}$, $I_C = 6.0 \text{ A}$	$T_J = -40^\circ\text{C}$ to 150°C	8.0	15	25	Mhos

DYNAMIC CHARACTERISTICS

Input Capacitance	C_{ISS}	$V_{CC} = 25 \text{ V}$, $V_{GE} = 0 \text{ V}$ $f = 1.0 \text{ MHz}$	$T_J = -40^\circ\text{C}$ to 150°C	-	1500	1800	pF
Output Capacitance	C_{OSS}			-	130	160	
Transfer Capacitance	C_{RSS}			-	6.0	8.0	

SWITCHING CHARACTERISTICS (Note 3.)

Turn-Off Delay Time (Inductive)	$t_{d(off)}$	$V_{CC} = 300 \text{ V}$, $I_C = 10 \text{ A}$ $R_G = 1.0 \text{ k}\Omega$, $L = 300 \mu\text{H}$	$T_J = 25^\circ\text{C}$	-	5.0	10	μSec
			$T_J = 150^\circ\text{C}$	-	6.0	10	
Fall Time (Inductive)	t_f	$V_{CC} = 300 \text{ V}$, $I_C = 10 \text{ A}$ $R_G = 1.0 \text{ k}\Omega$, $L = 300 \mu\text{H}$	$T_J = 25^\circ\text{C}$	-	6.0	10	μSec
			$T_J = 150^\circ\text{C}$	-	11	15*	
Turn-Off Delay Time (Resistive)	$t_{d(off)}$	$V_{CC} = 300 \text{ V}$, $I_C = 6.5 \text{ A}$ $R_G = 1.0 \text{ k}\Omega$, $R_L = 46 \Omega$	$T_J = 25^\circ\text{C}$	-	6.0	10	μSec
			$T_J = 150^\circ\text{C}$	-	7.0	10	
Fall Time (Resistive)	t_f	$V_{CC} = 300 \text{ V}$, $I_C = 6.5 \text{ A}$ $R_G = 1.0 \text{ k}\Omega$, $R_L = 46 \Omega$	$T_J = 25^\circ\text{C}$	-	12	20	μSec
			$T_J = 150^\circ\text{C}$	-	18	22*	
Turn-On Delay Time	$t_{d(on)}$	$V_{CC} = 10 \text{ V}$, $I_C = 6.5 \text{ A}$ $R_G = 1.0 \text{ k}\Omega$, $R_L = 1.5 \Omega$	$T_J = 25^\circ\text{C}$	-	1.5	2.0	μSec
			$T_J = 150^\circ\text{C}$	-	1.5	2.0	
Rise Time	t_r	$V_{CC} = 10 \text{ V}$, $I_C = 6.5 \text{ A}$ $R_G = 1.0 \text{ k}\Omega$, $R_L = 1.5 \Omega$	$T_J = 25^\circ\text{C}$	-	4.0	6.0	μSec
			$T_J = 150^\circ\text{C}$	-	5.0	6.0	

3. Pulse Test: Pulse Width $\leq 300 \mu\text{s}$, Duty Cycle $\leq 2\%$.

*Maximum Value of Characteristic across Temperature Range.

MGP19N35CL, MGB19N35CL

TYPICAL ELECTRICAL CHARACTERISTICS (unless otherwise noted)

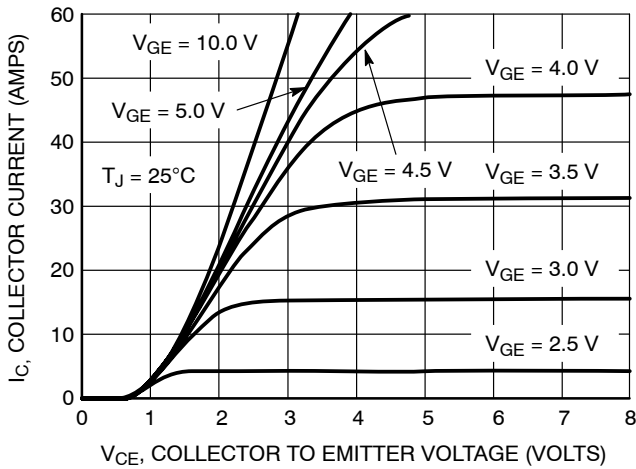

Figure 1. Output Characteristics

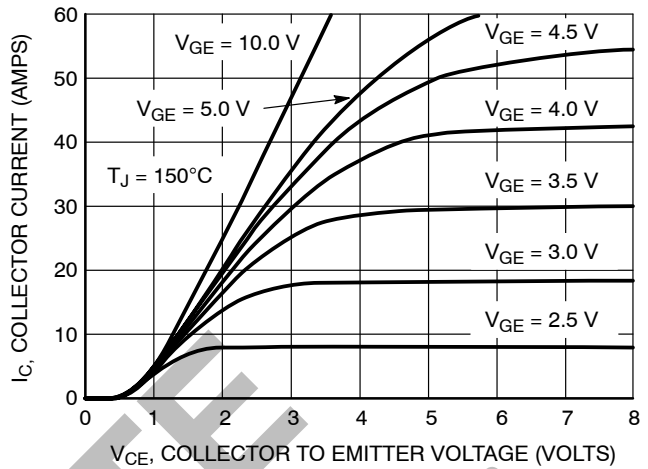

Figure 2. Output Characteristics

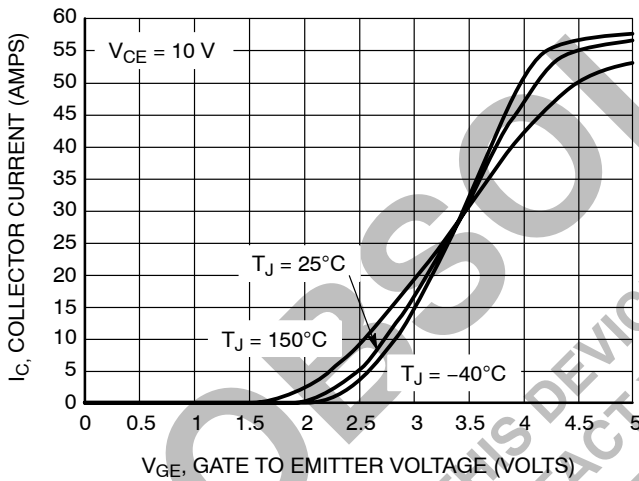

Figure 3. Transfer Characteristics

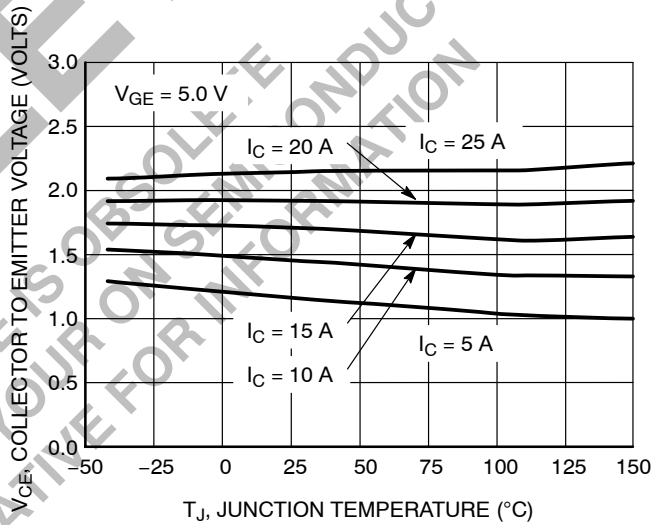

Figure 4. Collector-to-Emitter Saturation Voltage vs. Junction Temperature

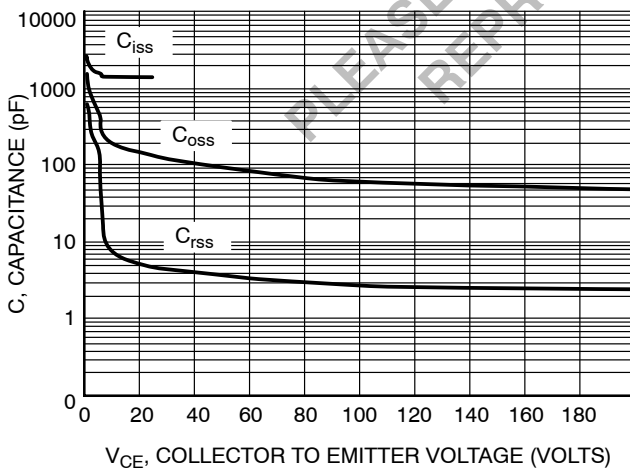

Figure 5. Capacitance Variation

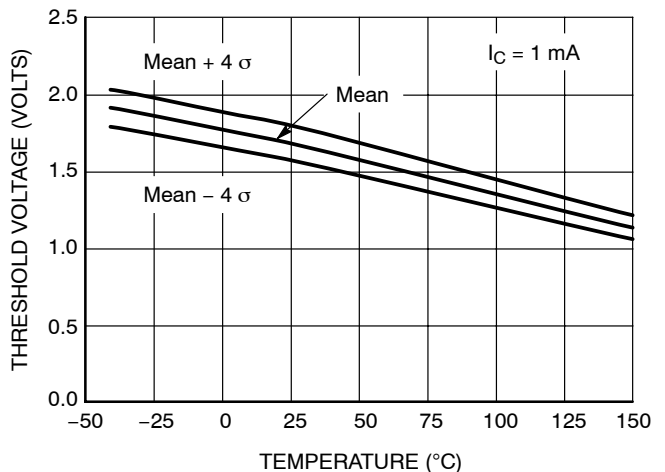

Figure 6. Threshold Voltage vs. Temperature

MGP19N35CL, MGB19N35CL

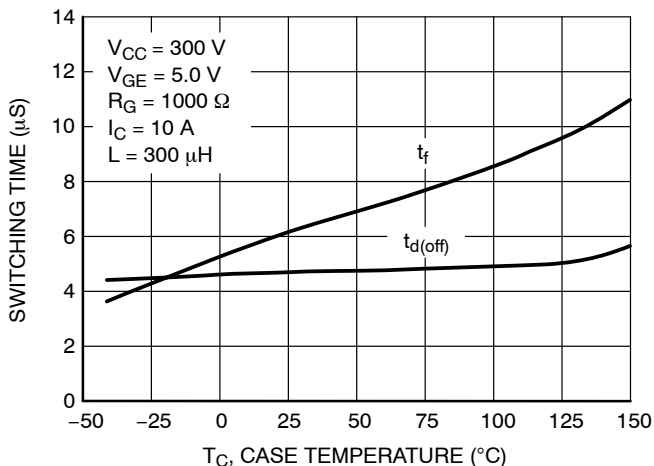

Figure 7. Switching Speed vs. Case Temperature

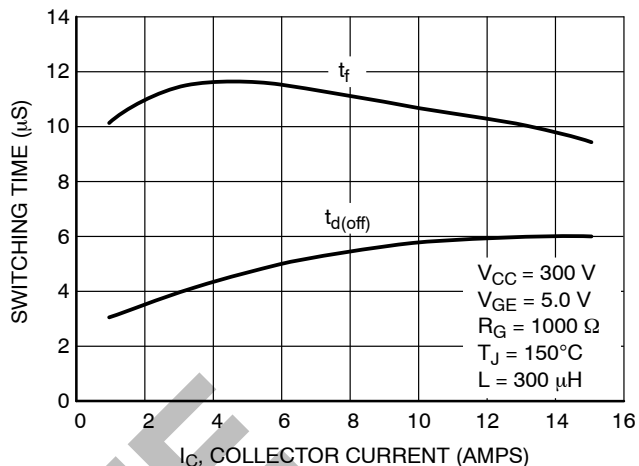

Figure 8. Switching Speed vs. Collector Current

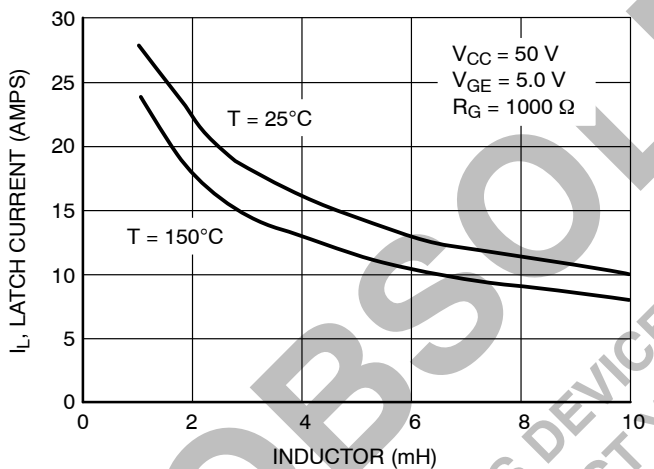

Figure 9. Minimum Open Secondary Latch Current vs. Inductor

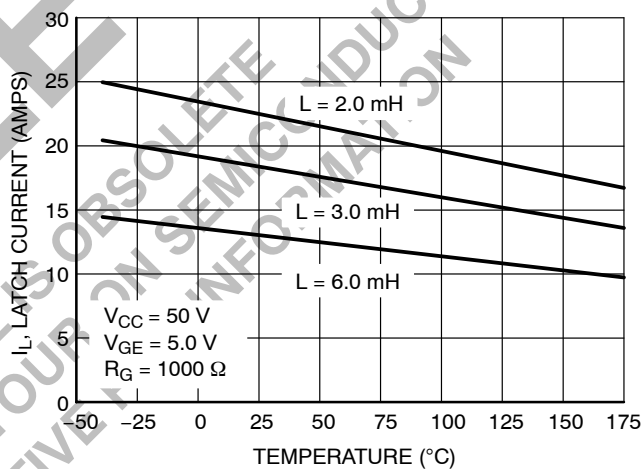

Figure 10. Minimum Open Secondary Latch Current vs. Temperature

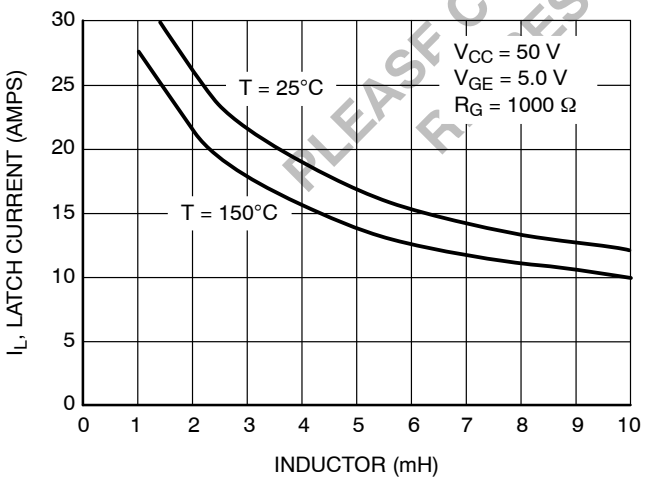

Figure 11. Typical Open Secondary Latch vs. Inductor

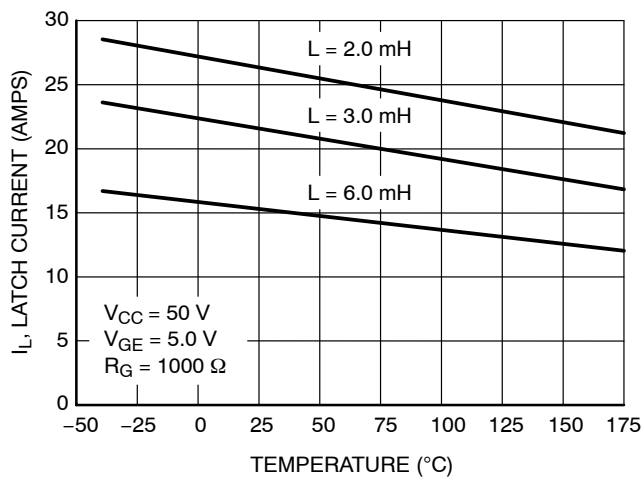

Figure 12. Typical Open Secondary Latch vs. Temperature

MGP19N35CL, MGB19N35CL

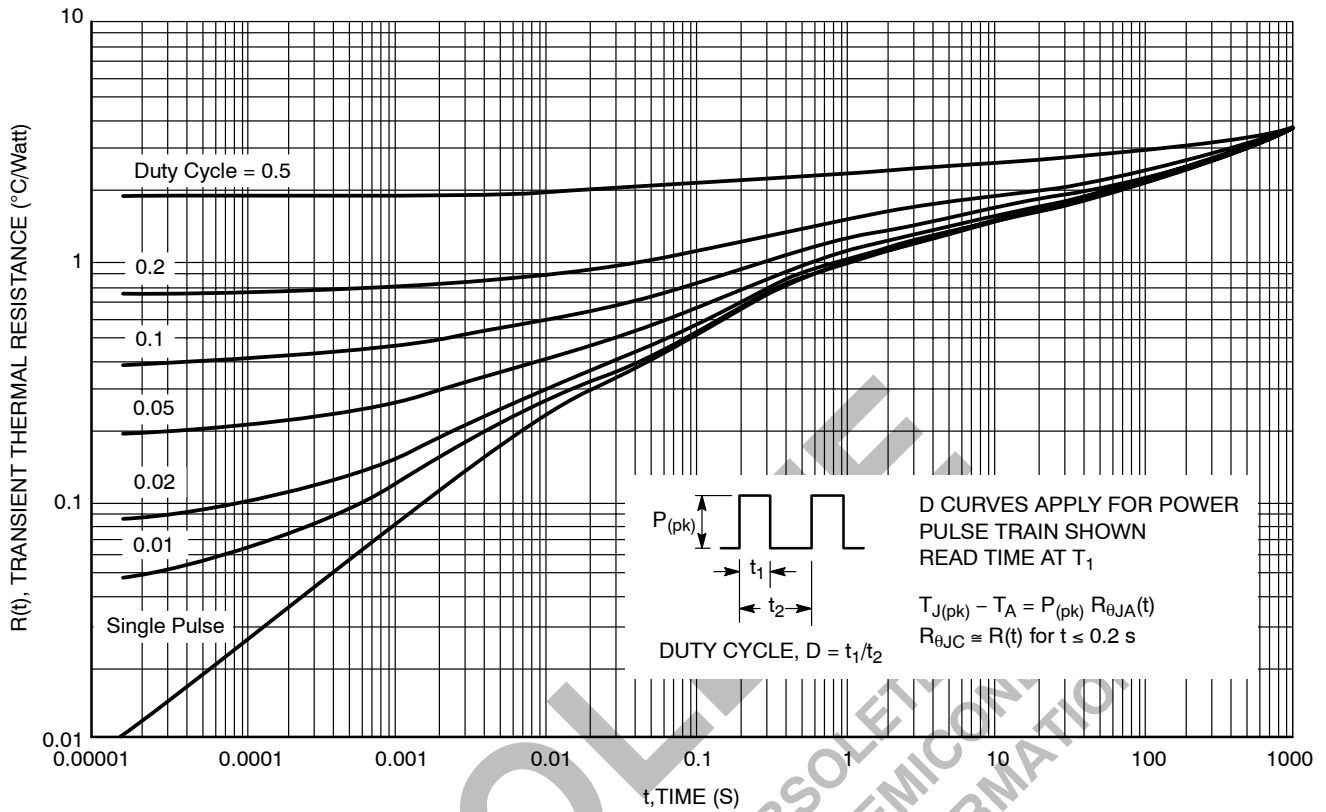

Figure 13. Transient Thermal Resistance (Non-normalized Junction-to-Ambient mounted on fixture in Figure 14)

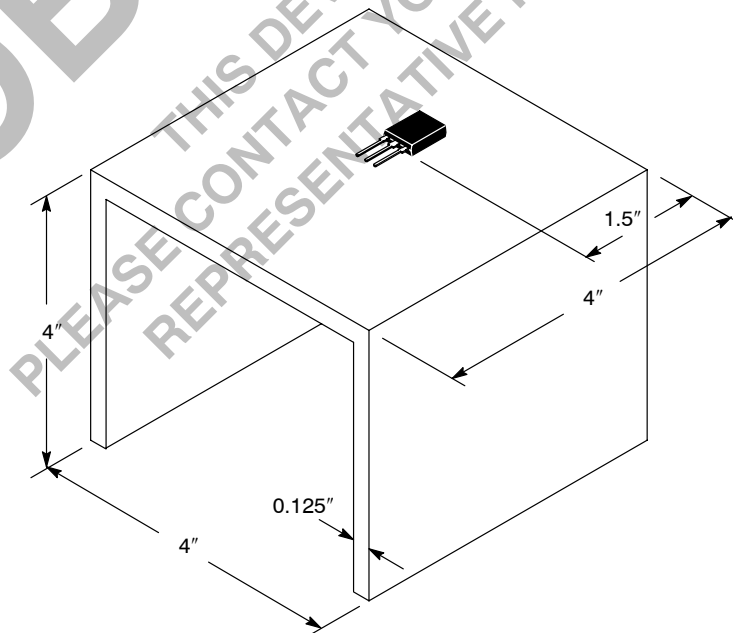

Figure 14. Test Fixture for Transient Thermal Curve (48 square inches of 1/8" thick aluminum)

MGP19N35CL, MGB19N35CL

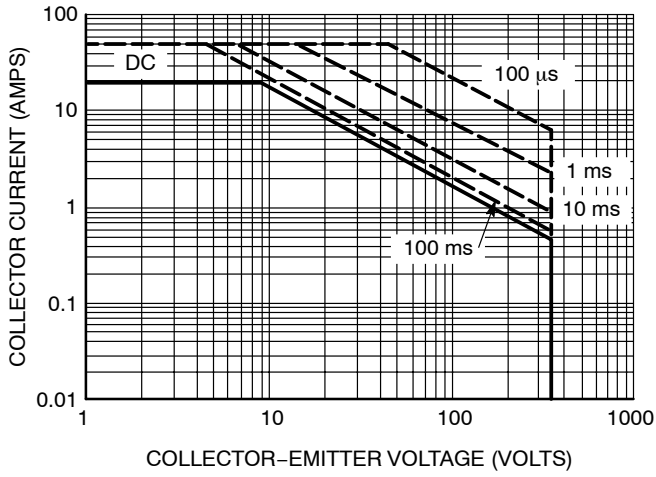

Figure 15. Single Pulse Safe Operating Area (Mounted on an Infinite Heatsink at $T_C = 25^\circ\text{C}$)

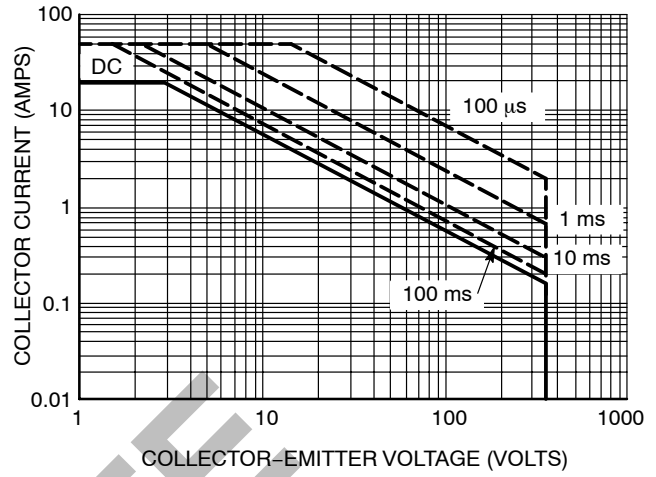

Figure 16. Single Pulse Safe Operating Area (Mounted on an Infinite Heatsink at $T_C = 125^\circ\text{C}$)

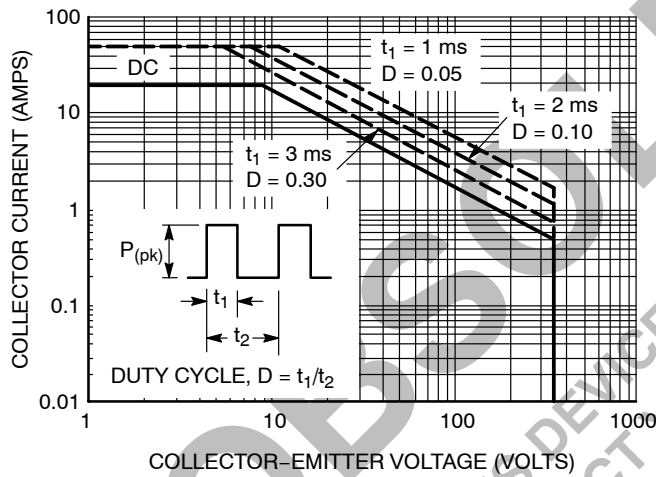

Figure 17. Pulse Train Safe Operating Area (Mounted on an Infinite Heatsink at $T_C = 25^\circ\text{C}$)

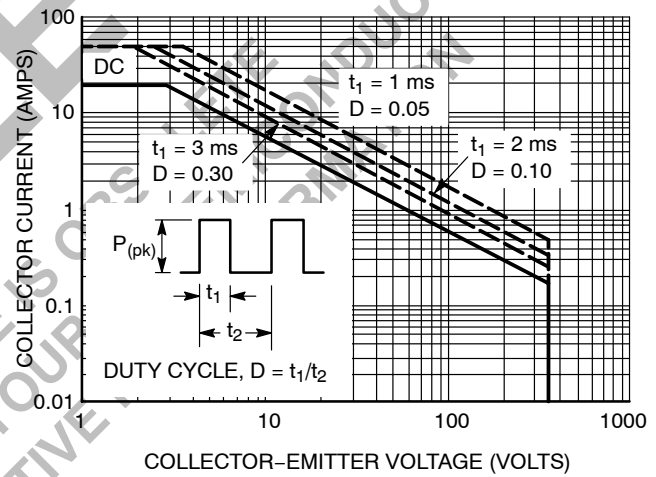
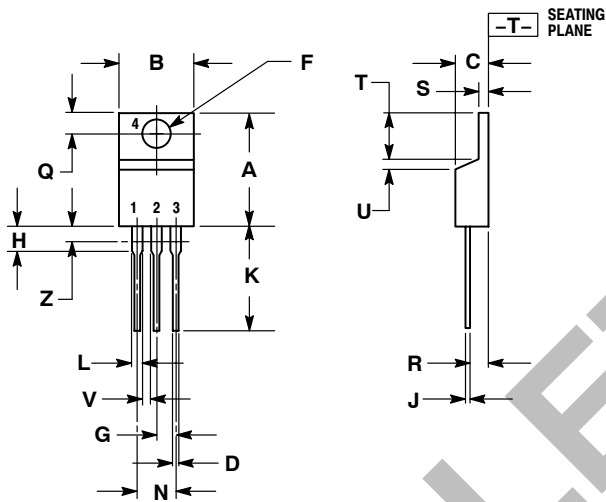

Figure 18. Pulse Train Safe Operating Area (Mounted on an Infinite Heatsink at $T_C = 125^\circ\text{C}$)

MGP19N35CL, MGB19N35CL

PACKAGE DIMENSIONS

TO-220 THREE-LEAD
TO-220AB
CASE 221A-09
ISSUE AA



NOTES:

1. DIMENSIONING AND TOLERANCING PER ANSI Y14.5M, 1982.
2. CONTROLLING DIMENSION: INCH.
3. DIMENSION Z DEFINES A ZONE WHERE ALL BODY AND LEAD IRREGULARITIES ARE ALLOWED.

DIM	INCHES		MILLIMETERS	
	MIN	MAX	MIN	MAX
A	0.570	0.620	14.48	15.75
B	0.380	0.405	9.66	10.28
C	0.160	0.190	4.07	4.82
D	0.025	0.035	0.64	0.88
F	0.142	0.147	3.61	3.73
G	0.095	0.105	2.42	2.66
H	0.110	0.155	2.80	3.93
J	0.018	0.025	0.46	0.64
K	0.500	0.562	12.70	14.27
L	0.045	0.060	1.15	1.52
N	0.190	0.210	4.89	5.33
Q	0.100	0.120	2.54	3.04
R	0.080	0.110	2.04	2.79
S	0.045	0.055	1.15	1.39
T	0.235	0.255	5.97	6.47
U	0.000	0.050	0.00	1.27
V	0.045	---	1.15	---
Z	---	0.080	---	2.04

STYLE 9:

- PIN 1. GATE
- COLLECTOR
- EMITTER
- COLLECTOR

OBSOLETE

THIS DEVICE IS OBSOLETE
PLEASE CONTACT YOUR ON SEMICONDUCTOR
REPRESENTATIVE FOR INFORMATION

MGP19N35CL, MGB19N35CL

PACKAGE DIMENSIONS

D²PAK
CASE 418B-03
ISSUE D

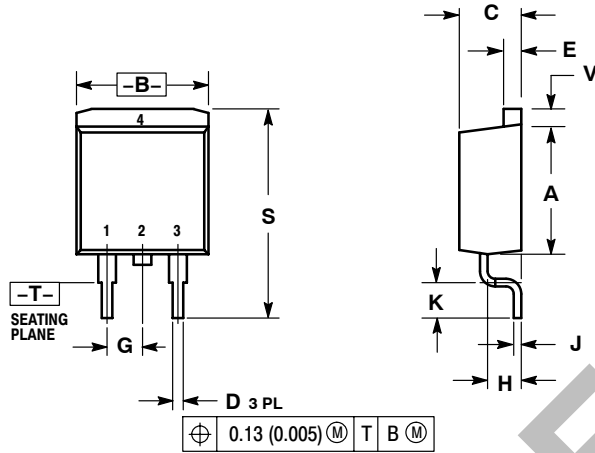

- NOTES:
1. DIMENSIONING AND TOLERANCING PER ANSI Y14.5M, 1982.
2. CONTROLLING DIMENSION: INCH.

DIM	INCHES		MILLIMETERS	
	MIN	MAX	MIN	MAX
A	0.340	0.380	8.64	9.65
B	0.380	0.405	9.65	10.29
C	0.160	0.190	4.06	4.83
D	0.020	0.035	0.51	0.89
E	0.045	0.055	1.14	1.40
G	0.100 BSC		2.54 BSC	
H	0.080	0.110	2.03	2.79
J	0.018	0.025	0.46	0.64
K	0.090	0.110	2.29	2.79
S	0.575	0.625	14.60	15.88
V	0.045	0.055	1.14	1.40

- STYLE 4:
PIN 1. GATE
2. COLLECTOR
3. EMITTER
4. COLLECTOR

OBSOLETE

THIS DEVICE IS OBSOLETE
PLEASE CONTACT YOUR ON SEMICONDUCTOR
REPRESENTATIVE FOR INFORMATION

Notes

OBSOLETE
THIS DEVICE IS OBSOLETE
PLEASE CONTACT YOUR ON SEMICONDUCTOR
REPRESENTATIVE FOR INFORMATION

Notes

OBSOLETE
THIS DEVICE IS OBSOLETE
PLEASE CONTACT YOUR ON SEMICONDUCTOR
REPRESENTATIVE FOR INFORMATION

MGP19N35CL, MGB19N35CL

ON Semiconductor and **ON** are trademarks of Semiconductor Components Industries, LLC (SCILLC). SCILLC reserves the right to make changes without further notice to any products herein. SCILLC makes no warranty, representation or guarantee regarding the suitability of its products for any particular purpose, nor does SCILLC assume any liability arising out of the application or use of any product or circuit, and specifically disclaims any and all liability, including without limitation special, consequential or incidental damages. "Typical" parameters which may be provided in SCILLC data sheets and/or specifications can and do vary in different applications and actual performance may vary over time. All operating parameters, including "Typicals" must be validated for each customer application by customer's technical experts. SCILLC does not convey any license under its patent rights nor the rights of others. SCILLC products are not designed, intended, or authorized for use as components in systems intended for surgical implant into the body, or other applications intended to support or sustain life, or for any other application in which the failure of the SCILLC product could create a situation where personal injury or death may occur. Should Buyer purchase or use SCILLC products for any such unintended or unauthorized application, Buyer shall indemnify and hold SCILLC and its officers, employees, subsidiaries, affiliates, and distributors harmless against all claims, costs, damages, and expenses, and reasonable attorney fees arising out of, directly or indirectly, any claim of personal injury or death associated with such unintended or unauthorized use, even if such claim alleges that SCILLC was negligent regarding the design or manufacture of the part. SCILLC is an Equal Opportunity/Affirmative Action Employer.

PUBLICATION ORDERING INFORMATION

NORTH AMERICA Literature Fulfillment:

Literature Distribution Center for ON Semiconductor
P.O. Box 5163, Denver, Colorado 80217 USA
Phone: 303-675-2175 or 800-344-3860 Toll Free USA/Canada
Fax: 303-675-2176 or 800-344-3867 Toll Free USA/Canada
Email: ONlit@hibbertco.com
Fax Response Line: 303-675-2167 or 800-344-3810 Toll Free USA/Canada

N. American Technical Support: 800-282-9855 Toll Free USA/Canada

EUROPE: LDC for ON Semiconductor – European Support

German Phone: (+1) 303-308-7140 (Mon-Fri 2:30pm to 7:00pm CET)
Email: ONlit-german@hibbertco.com
French Phone: (+1) 303-308-7141 (Mon-Fri 2:00pm to 7:00pm CET)
Email: ONlit-french@hibbertco.com
English Phone: (+1) 303-308-7142 (Mon-Fri 12:00pm to 5:00pm GMT)
Email: ONlit@hibbertco.com

EUROPEAN TOLL-FREE ACCESS*: 00-800-4422-3781

*Available from Germany, France, Italy, UK, Ireland

CENTRAL/SOUTH AMERICA:

Spanish Phone: 303-308-7143 (Mon-Fri 8:00am to 5:00pm MST)
Email: ONlit-spanish@hibbertco.com
Toll-Free from Mexico: Dial 01-800-288-2872 for Access –
then Dial 866-297-9322

ASIA/PACIFIC: LDC for ON Semiconductor – Asia Support

Phone: 303-675-2121 (Tue-Fri 9:00am to 1:00pm, Hong Kong Time)
Toll Free from Hong Kong & Singapore:
001-800-4422-3781
Email: ONlit-asia@hibbertco.com

JAPAN: ON Semiconductor, Japan Customer Focus Center

4-32-1 Nishi-Gotanda, Shinagawa-ku, Tokyo, Japan 141-0031
Phone: 81-3-5740-2700
Email: r14525@onsemi.com

ON Semiconductor Website: <http://onsemi.com>

For additional information, please contact your local Sales Representative.