

# MBRS540T3

Preferred Device

## Surface Mount Schottky Power Rectifier

The MBRS540T3 employs the Schottky Barrier principle in a large area metal-to-silicon power diode. State-of-the-art geometry features epitaxial construction with oxide passivation and metal overlay contact. Ideally suited for low voltage, high frequency rectification, or as free wheeling and polarity protection diodes in surface mount applications where compact size and weight are critical to the system.

### Features

- Small Compact Surface Mountable Package with J-Bend Leads
- Rectangular Package for Automated Handling
- Highly Stable Oxide Passivated Junction
- Excellent Ability to Withstand Reverse Avalanche Energy Transients
- Guard-Ring for Stress Protection
- Pb-Free Package is Available

### Mechanical Characteristics

- Case: Epoxy, Molded, Epoxy Meets UL 94 V-0 @ 0.125 in
- Weight: 217 mg (Approximately)
- Finish: All External Surfaces Corrosion Resistant and Terminal Leads are Readily Solderable
- Lead and Mounting Surface Temperature for Soldering Purposes: 260°C Max. for 10 Seconds
- Polarity: Notch in Plastic Body Indicates Cathode Lead
- ESD Rating: Machine Model, C (> 400 V)  
Human Body Model, 3B (> 8000 V)
- Device Meets MSL 1 Requirements

### MAXIMUM RATINGS

| Rating   | Symbol                          | Value       | Unit             |
|--|---------------------------------|-------------|------------------|
| Peak Repetitive Reverse Voltage<br>Working Peak Reverse Voltage<br>DC Blocking Voltage                         | $V_{RRM}$<br>$V_{RWM}$<br>$V_R$ | 40          | V                |
| Average Rectified Forward Current<br>(At Rated $V_R$ , $T_C = 105^\circ\text{C}$ )                             | $I_{F(AV)}$                     | 5           | A                |
| Peak Repetitive Forward Current<br>(At Rated $V_R$ , Square Wave,<br>20 KHz, $T_C = 80^\circ\text{C}$ )        | $I_{FRM}$                       | 10          | A                |
| Non-Repetitive Peak Surge Current<br>(Surge Applied at Rated Load Conditions<br>Halfwave, Single Phase, 60 Hz) | $I_{FSM}$                       | 190         | A                |
| Storage Temperature Range  | $T_{stg}$                       | -65 to +150 | $^\circ\text{C}$ |
| Operating Junction Temperature (Note 1)  | $T_J$                           | -65 to +150 | $^\circ\text{C}$ |
| Voltage Rate of Change (Rated $V_R$ )  | $dv/dt$                         | 10,000      | V/ $\mu\text{s}$ |

Maximum ratings are those values beyond which device damage can occur. Maximum ratings applied to the device are individual stress limit values (not normal operating conditions) and are not valid simultaneously. If these limits are exceeded, device functional operation is not implied, damage may occur and reliability may be affected.

The heat generated must be less than the thermal conductivity from junction to ambient:  $dP_D/dT_J < 1/R_{\theta JA}$ .



ON Semiconductor®

<http://onsemi.com>

## SCHOTTKY BARRIER RECTIFIER 5.0 AMPERES, 40 VOLTS



SMC  
CASE 403  
PLASTIC

### MARKING DIAGRAM

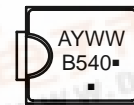

B540 = Specific Device Code  
A = Assembly Location  
Y = Year  
WW = Work Week  
▪ = Pb-Free Package  
(Note: Microdot may be in either location)

### ORDERING INFORMATION

| Device     | Package          | Shipping†        |
|------------|------------------|------------------|
| MBRS540T3  | SMC              | 2500/Tape & Reel |
| MBRS540T3G | SMC<br>(Pb-Free) | 2500/Tape & Reel |

†For information on tape and reel specifications, including part orientation and tape sizes, please refer to our Tape and Reel Packaging Specification Brochure, BRD8011/D.

Preferred devices are recommended choices for future use and best overall value.



# MBRS540T3

## THERMAL CHARACTERISTICS

| Characteristic                                      | Symbol          | Value | Unit          |
|---|-----------------|-------|---------------|
| Thermal Resistance,<br>Junction-to-Lead (Note 2)    | $R_{\theta JL}$ | 12    | $^{\circ}C/W$ |
| Thermal Resistance,<br>Junction-to-Ambient (Note 2) | $R_{\theta JA}$ | 111   |               |

## ELECTRICAL CHARACTERISTICS

|  |   |       |           |    |
|--|---|-------|-----------|----|
| Maximum Instantaneous Forward Voltage (Note 3) | ( $i_F = 5.0 \text{ A}$ , $T_C = 25^{\circ}C$ )                                       | $V_F$ | 0.50      | V  |
| Maximum Instantaneous Reverse Current (Note 3) | (Rated dc Voltage, $T_C = 25^{\circ}C$ )<br>(Rated dc Voltage, $T_C = 100^{\circ}C$ ) | $i_R$ | 0.3<br>15 | mA |

2. Rating applies when surface mounted on the minimum pad size recommended.

3. Pulse Test: Pulse Width  $\leq 300 \mu s$ , Duty Cycle  $\leq 2.0\%$ .

## TYPICAL CHARACTERISTICS

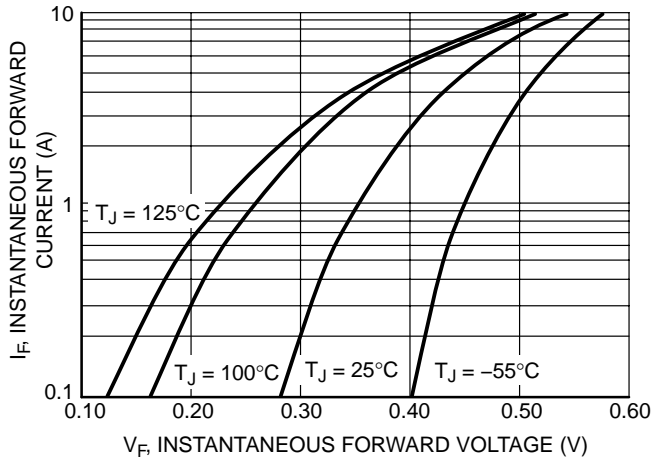

Figure 1. Typical Forward Voltage

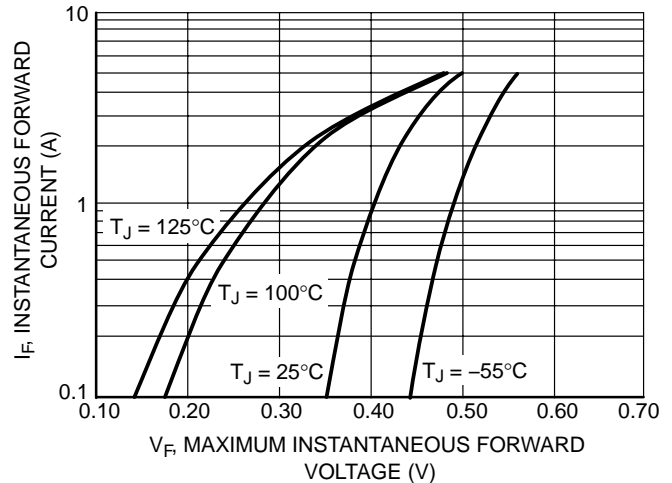

Figure 2. Maximum Forward Voltage

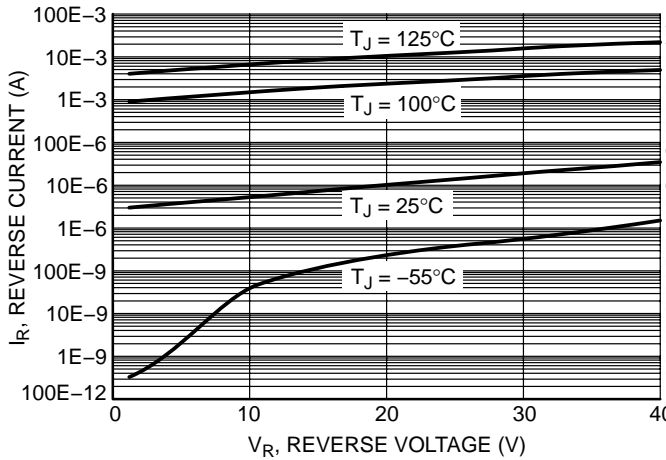

Figure 3. Typical Reverse Current

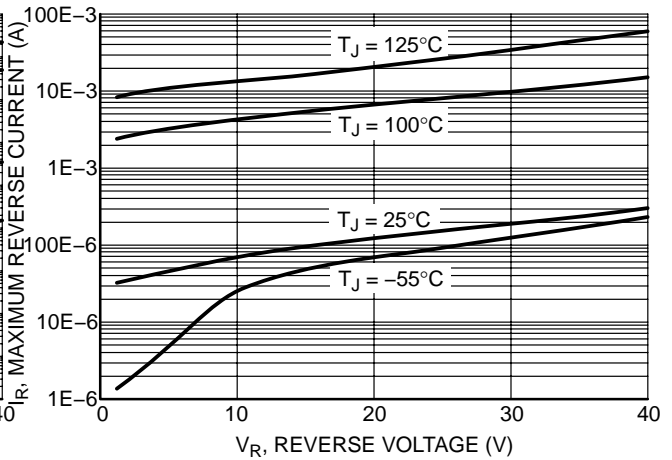

Figure 4. Maximum Reverse Current

# MBRS540T3

## TYPICAL CHARACTERISTICS

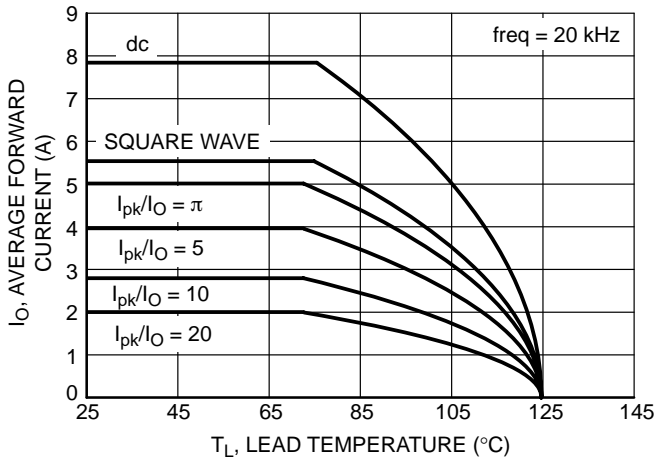

Figure 5. Current Derating

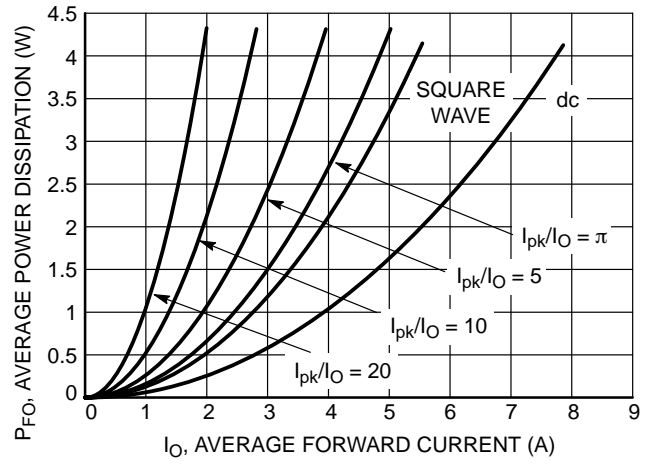

Figure 6. Forward Power Dissipation

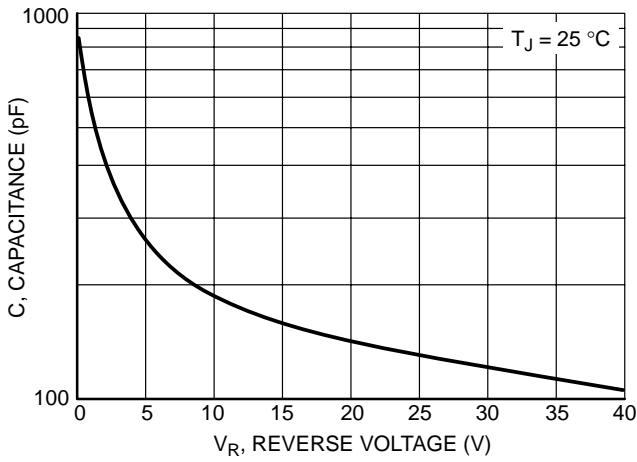

Figure 7. Capacitance

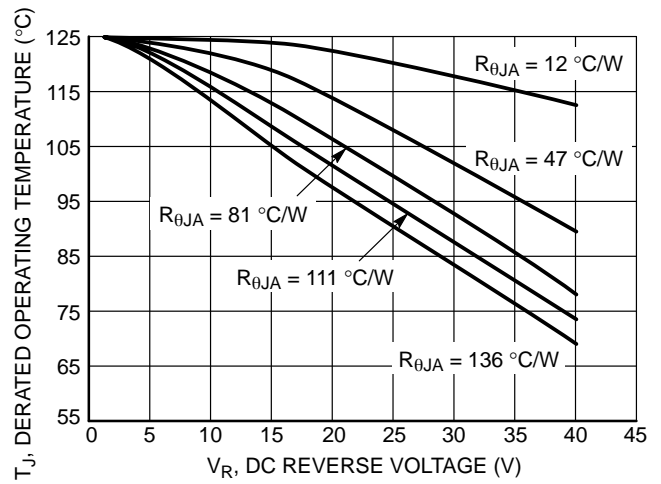

Figure 8. Typical Operating Temperature Derating

# MBRS540T3

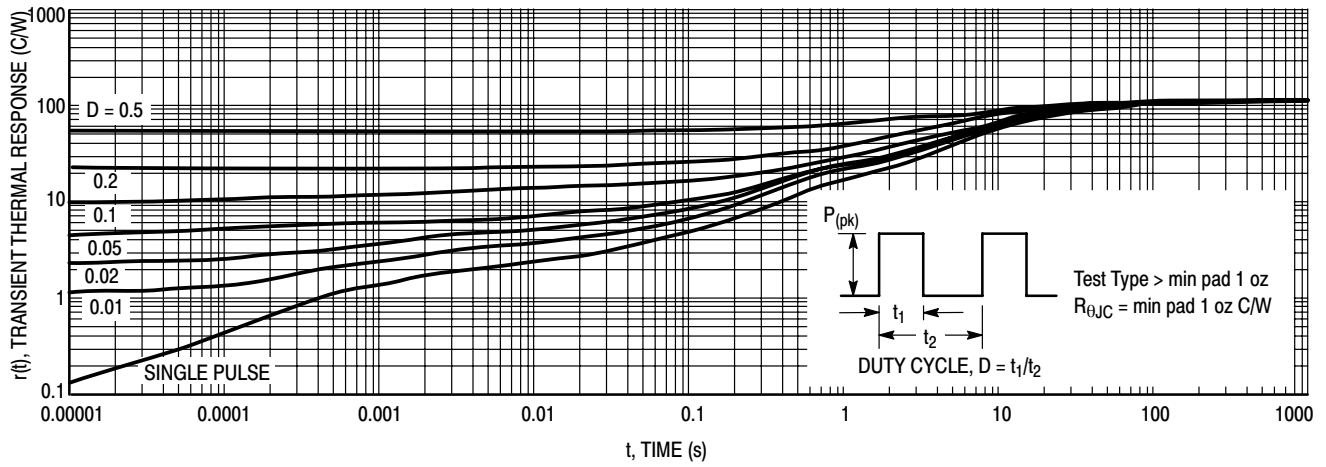

Figure 9. Thermal Response – MBR540T3 on min pad

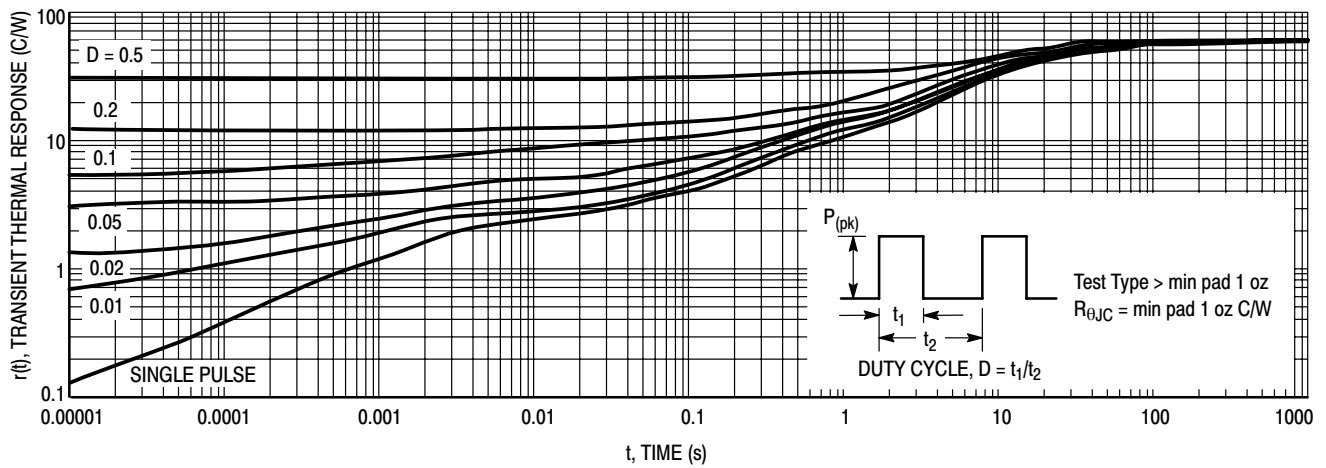
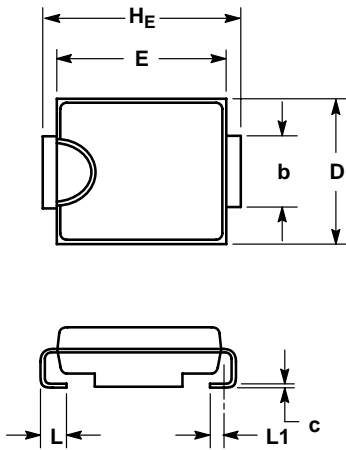

Figure 10. Thermal Response – MBR540T3 on 1" pad

# MBRS540T3

## PACKAGE DIMENSIONS

SMC  
CASE 403-03  
ISSUE E



NOTES:

1. DIMENSIONING AND TOLERANCING PER ANSI Y14.5M, 1982.
2. CONTROLLING DIMENSION: INCH.
3. D DIMENSION SHALL BE MEASURED WITHIN DIMENSION P.
4. 403-01 THRU -02 OBSOLETE, NEW STANDARD 403-03.

| DIM | MILLIMETERS |      |      | INCHES    |       |       |
|-----|-------------|------|------|-----------|-------|-------|
|     | MIN         | NOM  | MAX  | MIN       | NOM   | MAX   |
| A   | 1.90        | 2.13 | 2.41 | 0.075     | 0.084 | 0.095 |
| A1  | 0.05        | 0.10 | 0.15 | 0.002     | 0.004 | 0.006 |
| b   | 2.92        | 3.00 | 3.07 | 0.115     | 0.118 | 0.121 |
| c   | 0.15        | 0.23 | 0.30 | 0.006     | 0.009 | 0.012 |
| D   | 5.59        | 5.84 | 6.10 | 0.220     | 0.230 | 0.240 |
| E   | 6.60        | 6.86 | 7.11 | 0.260     | 0.270 | 0.280 |
| HE  | 7.75        | 7.94 | 8.13 | 0.305     | 0.313 | 0.320 |
| L   | 0.76        | 1.02 | 1.27 | 0.030     | 0.040 | 0.050 |
| L1  | 0.51 REF    |      |      | 0.020 REF |       |       |

### SOLDERING FOOTPRINT\*

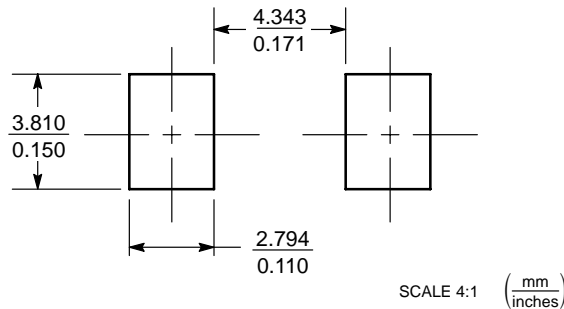

\*For additional information on our Pb-Free strategy and soldering details, please download the ON Semiconductor Soldering and Mounting Techniques Reference Manual, SOLDERRM/D.

ON Semiconductor and  are registered trademarks of Semiconductor Components Industries, LLC (SCILLC). SCILLC reserves the right to make changes without further notice to any products herein. SCILLC makes no warranty, representation or guarantee regarding the suitability of its products for any particular purpose, nor does SCILLC assume any liability arising out of the application or use of any product or circuit, and specifically disclaims any and all liability, including without limitation special, consequential or incidental damages. "Typical" parameters which may be provided in SCILLC data sheets and/or specifications can and do vary in different applications and actual performance may vary over time. All operating parameters, including "Typicals" must be validated for each customer application by customer's technical experts. SCILLC does not convey any license under its patent rights nor the rights of others. SCILLC products are not designed, intended, or authorized for use as components in systems intended for surgical implant into the body, or other applications intended to support or sustain life, or for any other application in which the failure of the SCILLC product could create a situation where personal injury or death may occur. Should Buyer purchase or use SCILLC products for any such unintended or unauthorized application, Buyer shall indemnify and hold SCILLC and its officers, employees, subsidiaries, affiliates, and distributors harmless against all claims, costs, damages, and expenses, and reasonable attorney fees arising out of, directly or indirectly, any claim of personal injury or death associated with such unintended or unauthorized use, even if such claim alleges that SCILLC was negligent regarding the design or manufacture of the part. SCILLC is an Equal Opportunity/Affirmative Action Employer. This literature is subject to all applicable copyright laws and is not for resale in any manner.

### PUBLICATION ORDERING INFORMATION

**LITERATURE FULFILLMENT:**

Literature Distribution Center for ON Semiconductor  
P.O. Box 61312, Phoenix, Arizona 85082-1312 USA  
Phone: 480-829-7710 or 800-344-3860 Toll Free USA/Canada  
Fax: 480-829-7709 or 800-344-3867 Toll Free USA/Canada  
Email: orderlit@onsemi.com

**N. American Technical Support:** 800-282-9855 Toll Free  
USA/Canada

**Japan:** ON Semiconductor, Japan Customer Focus Center  
2-9-1 Kamimeguro, Meguro-ku, Tokyo, Japan 153-0051  
Phone: 81-3-5773-3850

**ON Semiconductor Website:** <http://onsemi.com>

**Order Literature:** <http://www.onsemi.com/litorder>

For additional information, please contact your local Sales Representative.