

Auto-Adjusting Sync Separator for HD and SD Video

The ISL59885 video sync separator is manufactured using high performance analog CMOS process. This device extracts ISL59885 sync timing information from both standard and non-standard video input in the presence of Macrovision pulses. It provides composite sync, vertical sync, SD and HDTV detection, and horizontal sync outputs. Fixed 70mV sync tip slicing provides sync edge detection when the video input level is between 0.5V_{P-P} and 2V_{P-P}. Timing is adjusted automatically for various video standards. The composite sync output follows sync pulses and a vertical sync pulse is output on the rising edge of the first vertical serration following the vertical pre-equalizing string. For non-standard vertical inputs, a default vertical pulse is output when the vertical signal stays low for longer than the vertical sync default delay time. The horizontal output gives horizontal timing with pre/post equalizing pulses. ISL59885 has an auto input frequency detect feature that sets the right timing for any input format.

The ISL59885 is available in an 8 Ld SO package and is specified for operation over the full -40°C to +85°C temperature range.

Ordering Information

PART NUMBER	PART MARKING	PACKAGE	TAPE & REEL	PKG. DWG. #
ISL59885IS	59885IS	8 Ld SO	-	MDP0027
ISL59885IS-T7	59885IS	8 Ld SO	7"	MDP0027
ISL59885IS-T13	59885IS	8 Ld SO	13"	MDP0027
ISL59885ISZ (See Note)	59885ISZ	8 Ld SO (Pb-Free)	-	MDP0027
ISL59885ISZ-T7 (See Note)	59885ISZ	8 Ld SO (Pb-Free)	7"	MDP0027
ISL59885ISZ-T13 (See Note)	59885ISZ	8 Ld SO (Pb-Free)	13"	MDP0027
ISL59885ISR5218	59885IS	8 Ld SO	-	MDP0027
ISL59885ISR5218	59885ISZ	8 Ld SO (Pb-Free)	-	MDP0027
ISL59885IS-T7R5218	59885IS	8 Ld SO	7"	MDP0027
ISL59885ISZ-T7R5218	59885ISZ	8 Ld SO (Pb-Free)	7"	MDP0027
ISL59885IS-T13R5218	59885IS	8 Ld SO	13"	MDP0027
ISL59885ISZ-T13R5218	59885ISZ	8 Ld SO (Pb-Free)	13"	MDP0027

NOTE: Intersil Pb-free plus anneal products employ special Pb-free material sets; molding compounds/die attach materials and 100% matte tin plate termination finish, which are RoHS compliant and compatible with both SnPb and Pb-free soldering operations. Intersil Pb-free products are MSL classified at Pb-free peak reflow temperatures that meet or exceed the Pb-free requirements of IPC/JEDEC J STD-020.

Features

- NTSC, PAL, SECAM, HDTV, non-standard video sync separation
- Fixed 70mV slicing of video input levels from 0.5V_{P-P} to 2V_{P-P}
- Single 3V to 5V supply
- Composite sync output
- Vertical output
- Horizontal output
- HDTV detection
- 81% to 90% Hsync blanking window (R5218)
- Macrovision compatible
- Available in 8 Ld SO package
- Pb-Free plus anneal available (RoHS compliant)

Applications

- High definition video equipment

Demo Board

- A dedicated demo board is available

Pinout

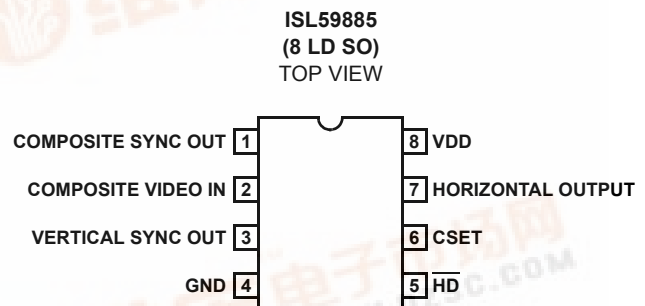

ISL59885

Absolute Maximum Ratings (T_A = 25°C)

V _{DD} Supply7V	Operating Junction Temperature +150°C
Pin Voltages -0.5V to V _{CC} +0.5V	Storage Temperature -65°C to +150°C
Operating Ambient Temperature Range -40°C to +85°C	Power Dissipation 400mW

CAUTION: Stresses above those listed in "Absolute Maximum Ratings" may cause permanent damage to the device. This is a stress only rating and operation of the device at these or any other conditions above those indicated in the operational sections of this specification is not implied.

NOTE: All parameters having Min/Max specifications are guaranteed. Typ values are for information purposes only. Unless otherwise noted, all tests are at the specified temperature and are pulsed tests, therefore: T_J = T_C = T_A

DC Electrical Specifications V_{DD} = 3.3V, T_A = 25°C, C_{SET} = 56nF, unless otherwise specified.

PARAMETER	DESCRIPTION	MIN	TYP	MAX	UNIT
I _{DD} , Quiescent	V _{DD} = 3.3V	1.5	2.2	4	mA
Clamp Voltage	Pin 2, I _{LOAD} = -100μA	1.35	1.5	1.65	V
Clamp Discharge Current	Pin 2 = 2V	6	15	30	μA
Clamp Charge Current	Pin 2 = 1V	-9	-7.2	-5.2	mA
V _{OL} Output Low Voltage	I _{OL} = 1.6mA		0.24	0.5	V
V _{OH} Output High Voltage	I _{OH} = -40μA	3	3.2		V
	I _{OH} = -1.6mA	2.5	3.0		V

Dynamic Characteristics

PARAMETER	DESCRIPTION	MIN	TYP	MAX	UNIT
Comp Sync Prop Delay, t _{CS}	See Figure 9		35	75	ns
Horizontal Sync Delay, t _{HS}	See Figure 9		40	80	ns
Horizontal Sync Width, t _{HS-PW}	See Figure 9	3.8	5.2	6.2	μs
Vertical Sync Width, t _{VS}	Normal or default trigger, 50% - 50%, see Figure 7	230	280	350	μs
Vertical Sync Default Delay, t _{VSD}	See Figure 10	28	50	68	μs
Hsync Blanking Window	ISL59885IS-R5218 only	81	85	90	%
Input Dynamic Range	Video input amplitude to maintain slice level spec, V _{DD} = 3.3V	0.5		2	V _{P-P}
Slice Level	V _{SLICE} above V _{CLAMP}	50	70	90	mV
$\overline{\text{HD}}$ Pin Level	720p, 1080i, 1080p		0		V

Pin Descriptions

PIN NUMBER	PIN NAME	PIN FUNCTION
1	COMPOSITE SYNC OUT	Composite sync pulse output; sync pulses start on a falling edge and end on a rising edge
2	COMPOSITE VIDEO IN	AC coupled composite video input; sync tip must be at the lowest potential (positive picture phase)
3	VERTICAL SYNC OUT	Vertical sync pulse output; the falling edge of vert sync is the start of the vertical period
4	GND	Supply ground
5	$\overline{\text{HD}}$	Low when input horizontal frequency is greater than 20kHz
6	CSET	(An external capacitor to ground); bypass pin for internal bias generator.
7	HORIZONTAL OUTPUT	Horizontal output; falling edge active
8	VDD	Positive supply

Typical Performance Curves

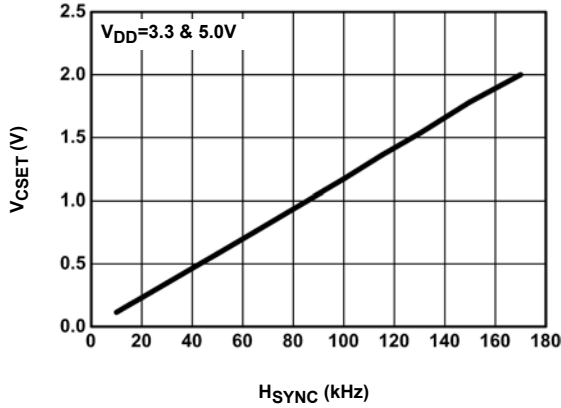

FIGURE 1. H_{SYNC} vs V_{CSET} (R_{SET} = OPEN)

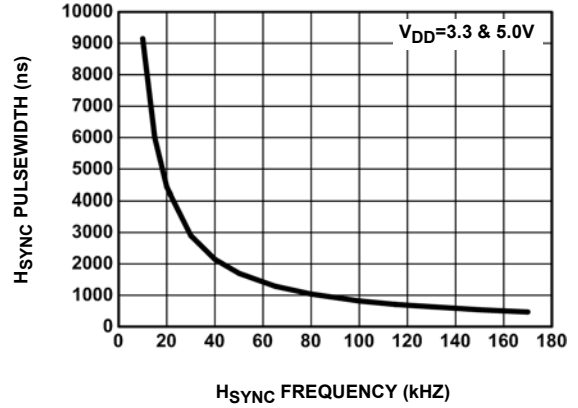

FIGURE 2. H_{SYNC} PULSEWIDTH vs H_{SYNC} FREQUENCY (R_{SET} = OPEN)

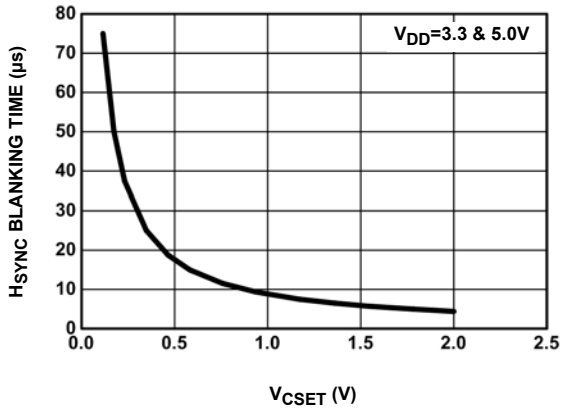

FIGURE 3. H_{SYNC} vs V_{CSET} (R_{SET} = OPEN)

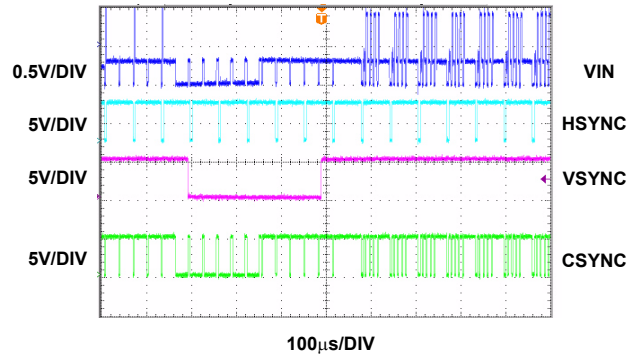

FIGURE 4. MACROVISION COMPATIBILITY (NTSC)

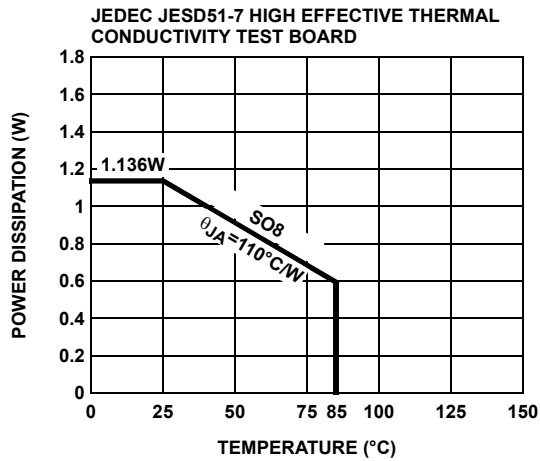

FIGURE 5. PACKAGE POWER DISSIPATION vs AMBIENT TEMPERATURE

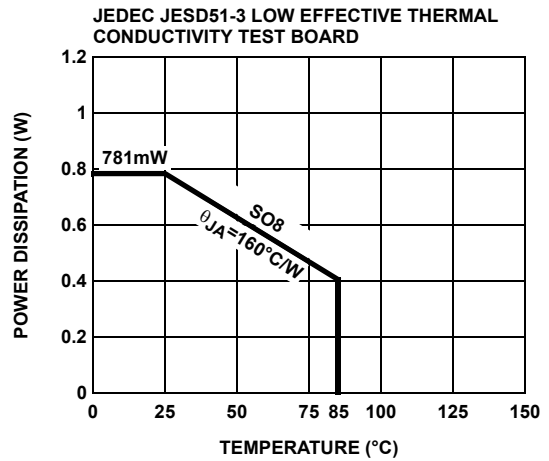
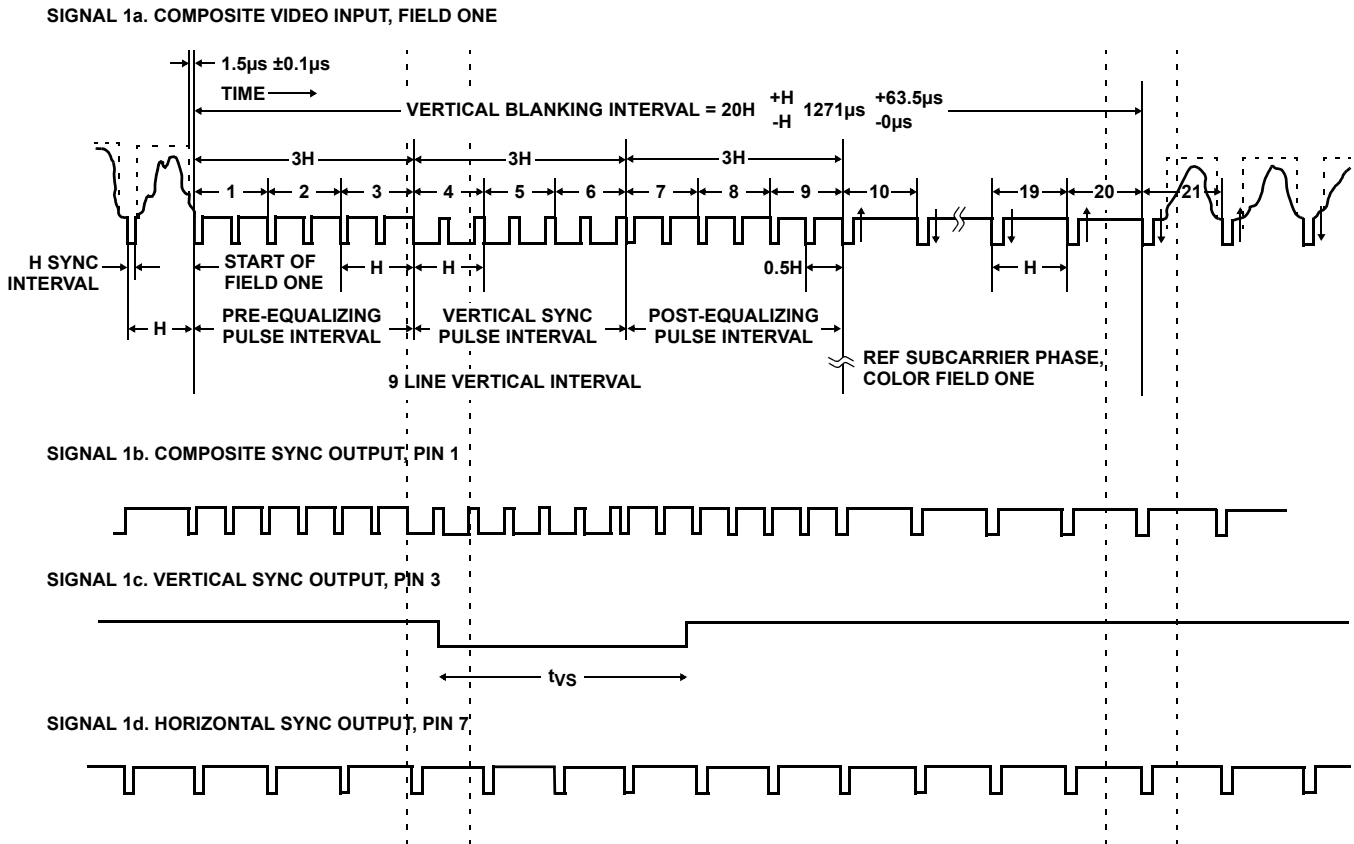

FIGURE 6. PACKAGE POWER DISSIPATION vs AMBIENT TEMPERATURE

ISL59885



NOTES:

- b. The composite sync output reproduces all the video input sync pulses, with a propagation delay.
- c. Vertical sync leading edge is coincident with the first vertical serration pulse leading edge, with a propagation delay.
- d. Horizontal sync output produces the true "H" pulses of nominal width of 5µs. It has the same delay as the composite sync.

FIGURE 7. TIMING DIAGRAM

ISL59885

CONDITIONS: $V_{DD} = 3.3V/5V$, $T_A = 25^\circ C$

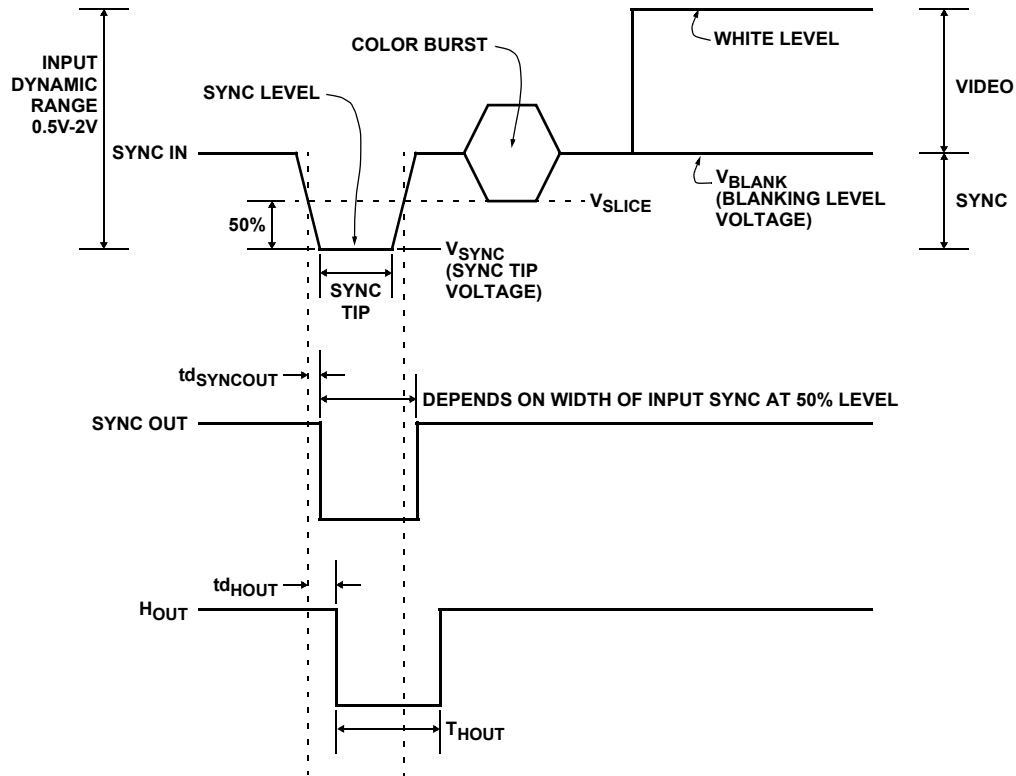

FIGURE 8. HORIZONTAL INTERVAL 525/625 LINE COMPOSITE

PARAMETER	DESCRIPTION	CONDITIONS	TYP (Note 1)	UNIT
$t_{dSYNCOUT}$	SYNCOUT Timing Relative to Input	See Figure 8	65	ns
t_{dHOUT}	HOUT Timing Relative to Input	See Figure 8	470	ns
T_{HOUT}	Horizontal Output Width	See Figure 8	5.2	us

NOTE:

1. Delay variation is less than 2.5ns over temperature range.

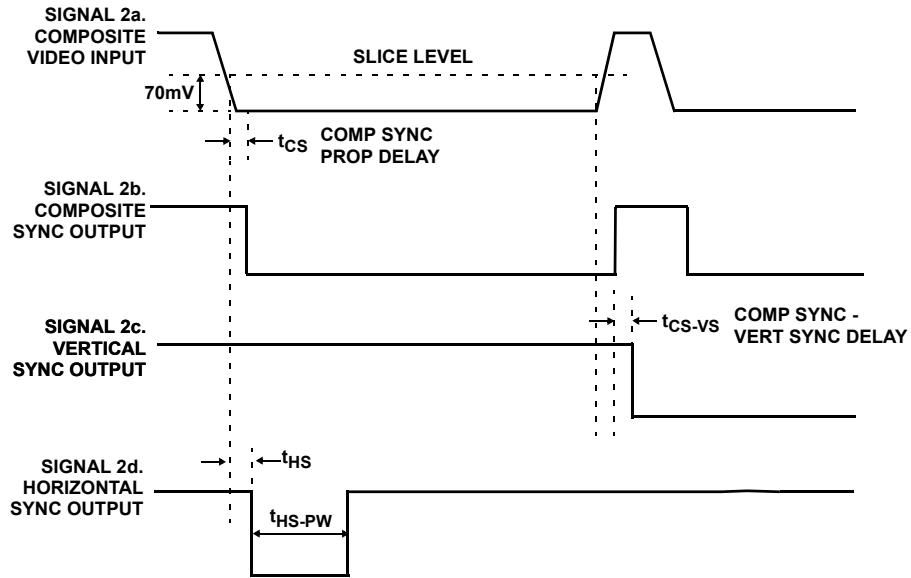

FIGURE 9. STANDARD VERTICAL TIMING

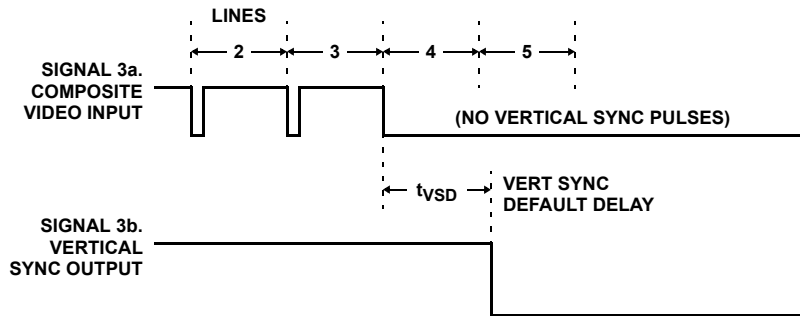
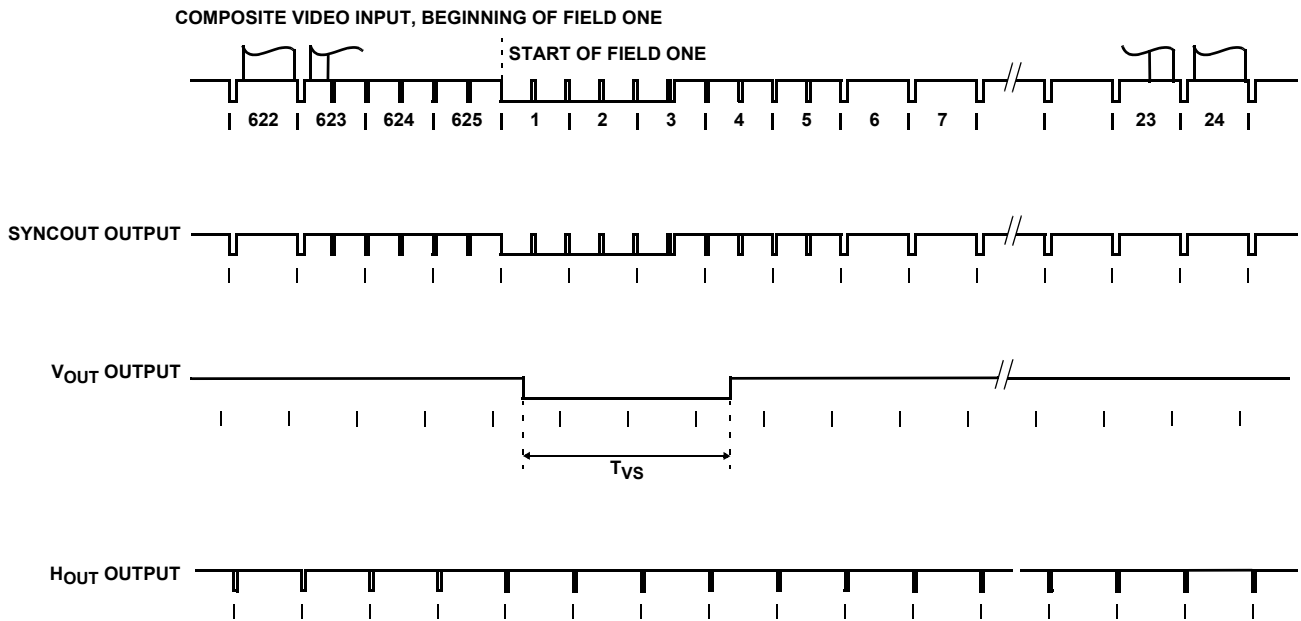

FIGURE 10. NON-STANDARD VERTICAL TIMING

ISL5985



NOTES:

- b. The composite sync output reproduces all the video input sync pulses, with a propagation delay.
- c. Vertical sync leading edge is coincident with the first vertical serration pulse leading edge, with a propagation delay.

FIGURE 11. EXAMPLE OF VERTICAL INTERVAL (625)

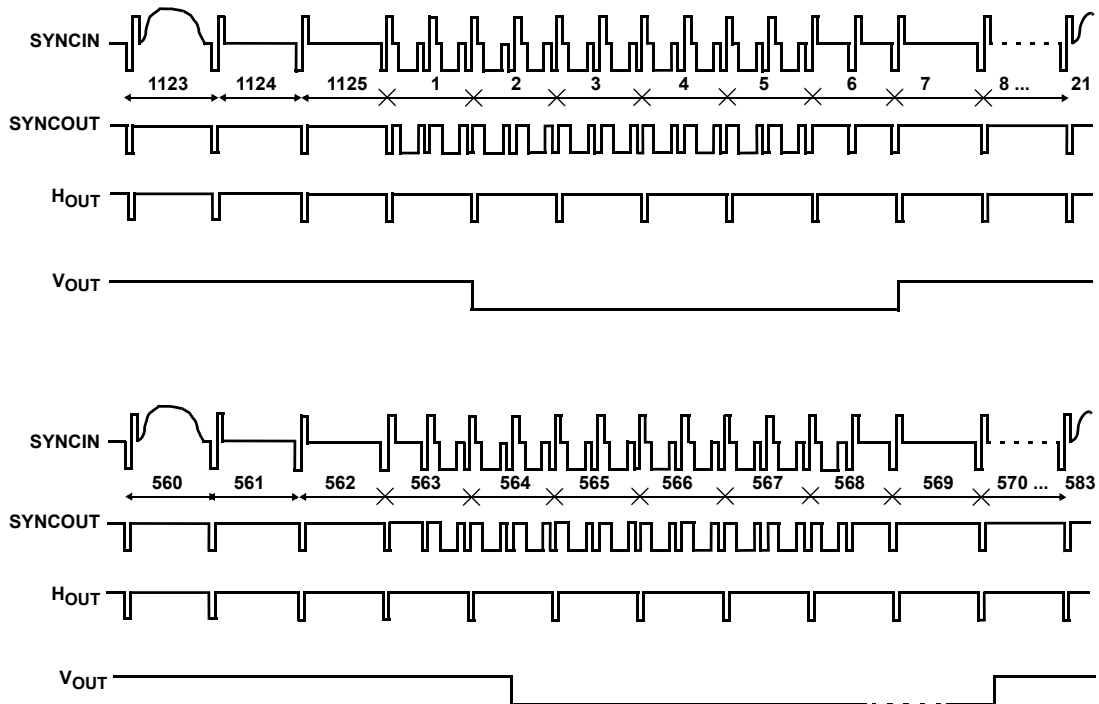

FIGURE 12. EXAMPLE OF HDTV 1080I/30 LINE COMPOSITE VIDEO: INTERLACED

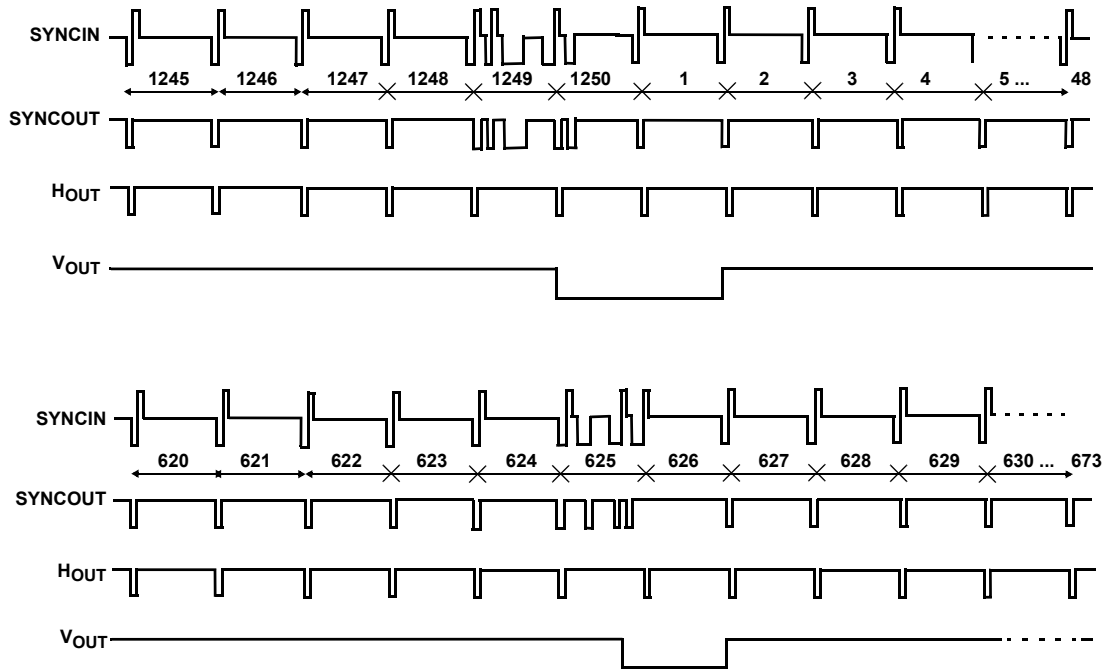

FIGURE 13. HDTV 1080I/25 LINE COMPOSITE VIDEO: INTERLACED (1250 LINES)

ISL59885

CONDITIONS: $V_{DD} = 3.3V/5V$, $T_A = 25^\circ C$

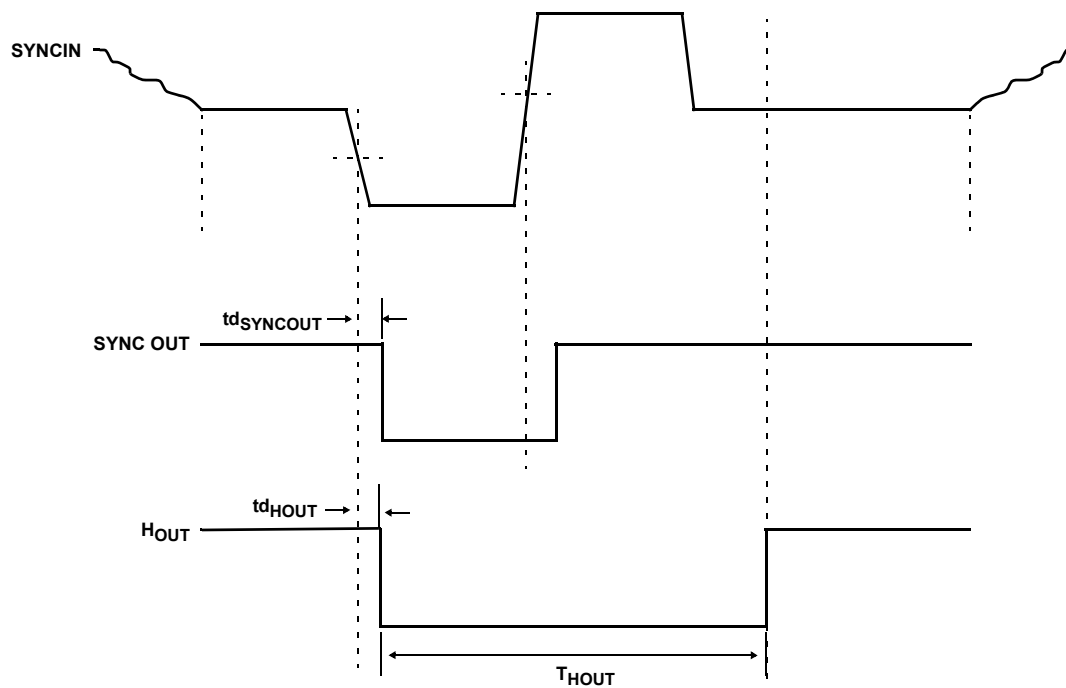

FIGURE 14. HORIZONTAL INTERVAL (HDTV) (720p)

H Timing for HDTV, No Filter (using 720p input signal)

PARAMETER	DESCRIPTION	CONDITIONS	TYP @ 3.3V (Note 1)	TYP @ 5V (Note 1)	UNIT
$t_{d_SYNCOUT}$	SYNCOUT Timing Relative to Input	See Figure 14	56	50	ns
t_{d_HOUT}	HOUT Timing Relative to Input	See Figure 14	48	36	ns
T_{HOUT}	Horizontal Output Width	See Figure 14	1.90	1.90	us

NOTE:

1. Delay variation is less than 2.5ns over temperature range.

ISL59885

CONDITIONS: $V_{DD} = 3.3V/5V$, $T_A = 25^\circ C$

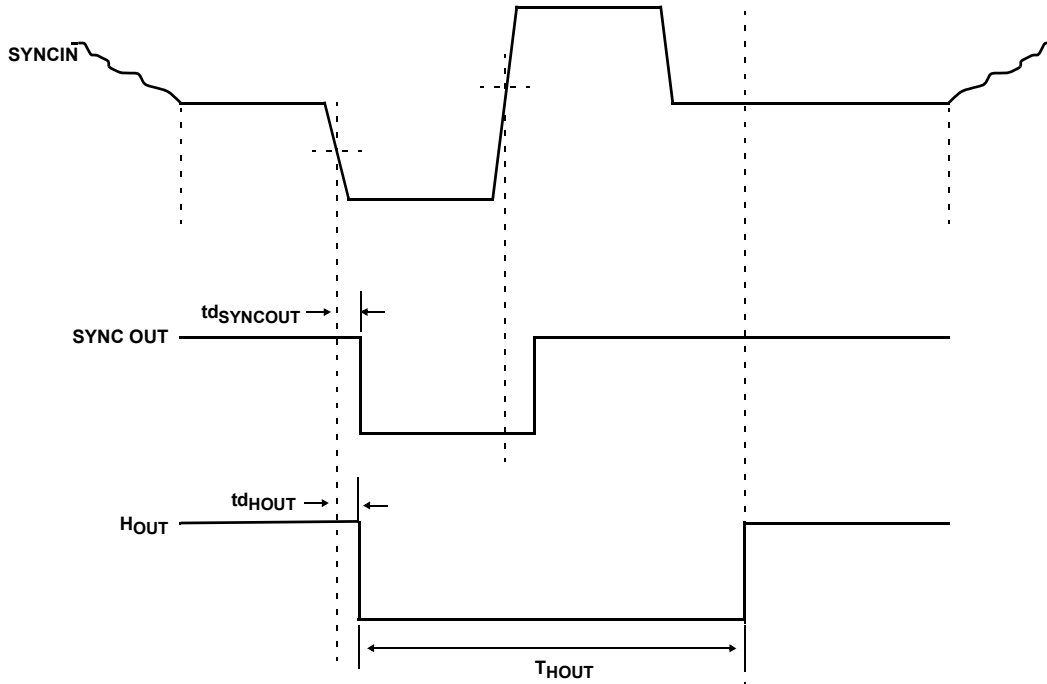

FIGURE 15. HORIZONTAL INTERVAL (HDTV) (720p)

H Timing for HDTV, With Filter (using 720p input)

PARAMETER	DESCRIPTION	CONDITIONS	TYP @ 3.3V (Note 1)	TYP @ 5V (Note 1)	UNIT
$t_{dSYNCOUT}$	SYNCOUT Timing Relative to Input	See Figure 15	120	110	ns
t_{dHOUT}	HOUT Timing Relative to Input	See Figure 15	112	100	ns
T_{HOUT}	Horizontal Output Width	See Figure 15	200	200	ns

NOTE:

1. Delay variation is less than 2.5ns over temperature range.

Applications Information

Video In

A simplified block diagram is shown following page.

An AC coupled video signal is input to Video In pin 2 via C_1 , nominally $0.1\mu\text{F}$. Clamp charge current will prevent the signal on pin 2 from going any more negative than Sync Tip Ref, about 1.5V . This charge current is nominally about 1mA . A clamp discharge current of about $10\mu\text{A}$ is always attempting to discharge C_1 to Sync Tip Ref, thus charge is lost between sync pulses that must be replaced during sync pulses. The droop voltage that will occur can be calculated from $IT = CV$, where V is the droop voltage, I is the discharge current, T is the time between sync pulses (sync period - sync tip width), and C is C_1 .

An NTSC video signal has a horizontal frequency of 15.73kHz , and a sync tip width of $4.7\mu\text{s}$. This gives a period of $63.6\mu\text{s}$ and a time $T = 58.9\mu\text{s}$. The droop voltage will then be $V = 5.9\text{mV}$. This is less than 2% of a nominal sync tip amplitude of 286mV . The charge represented by this droop is replaced in a time given by $T = CV/I$, where $I =$ clamp charge current = 5.3mA . Here $T = 590\text{ns}$, about 12% of the sync pulse width of $4.7\mu\text{s}$. It is important to choose C_1 large enough so that the droop voltage does not approach the switching threshold of the internal comparator.

Composite Sync

The Composite Sync output is simply a reproduction of the input signal with the active video removed. The sync tip of the Composite video signal is clamped to 1.5V at pin 2 and then slices at 70mV above the sync tip reference. The output signal is buffered out to pin 1. When loss of sync, the Composite Sync output is held low.

Vertical Sync

A low-going Vertical Sync pulse is output during the start of the vertical cycle of the incoming video signal. The vertical cycle starts with a pre-equalizing phase of pulses with a duty cycle of about 93%, followed by a vertical serration phase that has a duty cycle of about 15%. Vertical Sync is clocked out of the ISL59885 on the first rising edge during the vertical serration phase. In the absence of vertical serration pulses, a vertical sync pulse will be forced out after the vertical sync default delay time, approximately $60\mu\text{s}$ after the last falling edge of the vertical equalizing phase.

Horizontal Sync

The horizontal circuit senses the composite sync edges and produces the true horizontal pulses of nominal width $5.2\mu\text{s}$. The leading edge is triggered from the leading edge of the input H sync, with the same propagation delay as composite sync. The half line pulses present in the input signal during vertical blanking are removed with an internal 2H line eliminator circuit. This is a circuit that inhibits horizontal output pulses until 75% of the line time is reached, then the horizontal output operation is enabled again. Any signals

present on the I/P signal after the true H sync will be ignored, thus the horizontal output will not be affected by MacroVision copy protection. When loss of sync, the Horizontal Sync output is held high.

C_{SET}

An external C_{SET} capacitor connected from C_{SET} pin 6 to ground. C_{SET} capacitor should be a X7R grade or better as the Y5U general use capacitors may be too leaky and cause faulty operation. The C_{SET} capacitor should be very close to the C_{SET} pin to reduce possible board leakage. 56nF is recommended. C_{SET} simplified block diagram is shown in diagram 5. The C_{SET} capacitor rectifies $5\mu\text{s}$ pulse current and creates a voltage on C_{SET} . The C_{SET} voltage is converted to bias current for H_{SYNC} and V_{SYNC} timing.

Chroma Filter

A chroma filter is suggested to increase the S/N ratio of the incoming video signal. Use of the optional chroma filter is shown in the figure below. It can be implemented very simply and inexpensively with a series resistor of 100Ω and a capacitor of 570pF , which gives a single pole roll-off frequency of about 2.79MHz during NTSC or PAL. This sufficiently attenuates the 3.58MHz (NTSC) or 4.43MHz (PAL) color burst signal, yet passes the approximately 15kHz sync signals without appreciable attenuation. During HDTV, the transistor turns off and a 100pF capacitor is left to filter any noise present at the input. A chroma filter will increase the propagation delay from the composite input to the outputs.

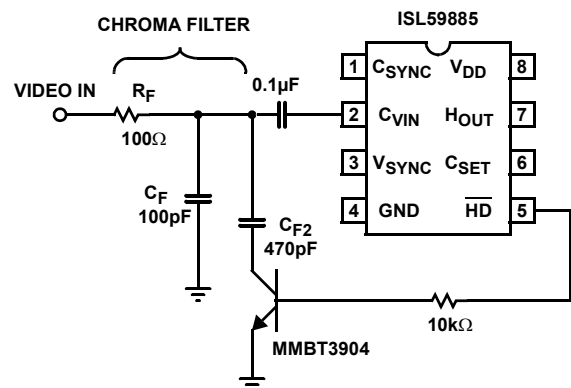

HD-Detect

High definition video is flagged by \overline{HD} going low when the input horizontal frequency is greater than 20kHz .

ISL59885

Package Outline Drawing

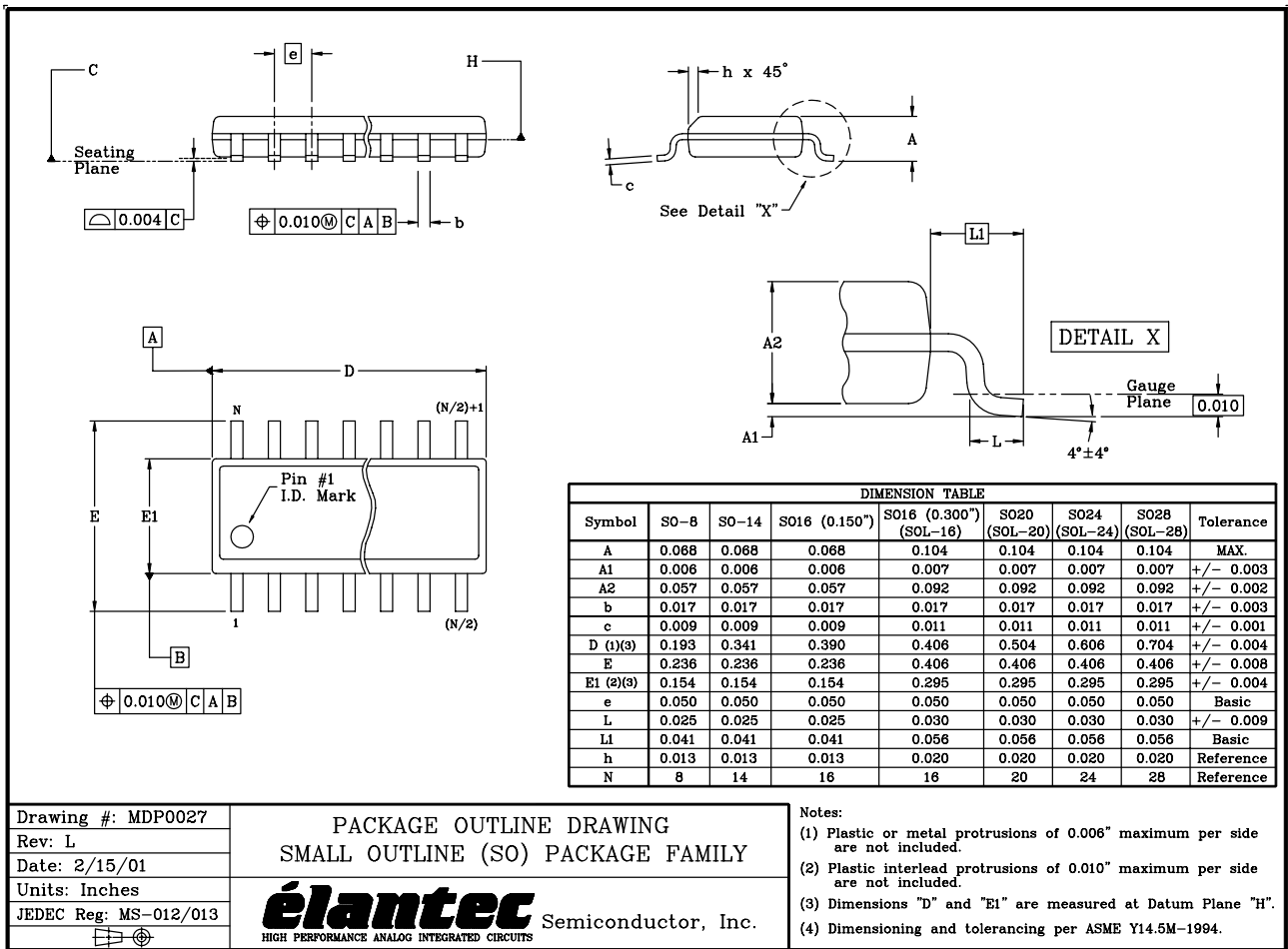

NOTE: The package drawing shown here may not be the latest version. To check the latest revision, please refer to the Intersil website at <http://www.intersil.com/design/packages/index.asp>

All Intersil U.S. products are manufactured, assembled and tested utilizing ISO9000 quality systems. Intersil Corporation's quality certifications can be viewed at www.intersil.com/design/quality

Intersil products are sold by description only. Intersil Corporation reserves the right to make changes in circuit design, software and/or specifications at any time without notice. Accordingly, the reader is cautioned to verify that data sheets are current before placing orders. Information furnished by Intersil is believed to be accurate and reliable. However, no responsibility is assumed by Intersil or its subsidiaries for its use; nor for any infringements of patents or other rights of third parties which may result from its use. No license is granted by implication or otherwise under any patent or patent rights of Intersil or its subsidiaries.

For information regarding Intersil Corporation and its products, see www.intersil.com