

Freescale Semiconductor
Technical Data

Document Number: MRF6S19140H
Rev. 3, 8/2005

RF Power Field Effect Transistors

N-Channel Enhancement-Mode Lateral MOSFETs

Designed for PCN and PCS base station applications with frequencies from 1930 to 1990 MHz. Suitable for TDMA, CDMA and multicarrier amplifier applications. To be used in Class AB for PCN-PCS/cellular radio and WLL applications.

- Typical 2-Carrier N-CDMA Performance: $V_{DD} = 28$ Volts, $I_{DQ} = 1150$ mA, $P_{out} = 29$ Watts Avg., Full Frequency Band. IS-95 (Pilot, Sync, Paging, Traffic Codes 8 Through 13) Channel Bandwidth = 1.2288 MHz. PAR = 9.8 dB @ 0.01% Probability on CCDF.
Power Gain — 16 dB
Drain Efficiency — 27.5%
IM3 @ 2.5 MHz Offset — -37 dBc @ 1.2288 MHz Channel Bandwidth
ACPR @ 885 kHz Offset — -51 dBc @ 30 kHz Channel Bandwidth
- Capable of Handling 10:1 VSWR, @ 28 Vdc, 1960 MHz, 140 Watts CW Output Power
- Characterized with Series Equivalent Large-Signal Impedance Parameters
- Internally Matched for Ease of Use
- Qualified Up to a Maximum of 32 V_{DD} Operation
- Integrated ESD Protection
- Lower Thermal Resistance Package
- Designed for Lower Memory Effects and Wide Instantaneous Bandwidth Applications
- Low Gold Plating Thickness on Leads, 40 μ m Nominal.
- Pb-Free and RoHS Compliant
- In Tape and Reel. R3 Suffix = 250 Units per 56 mm, 13 inch Reel.

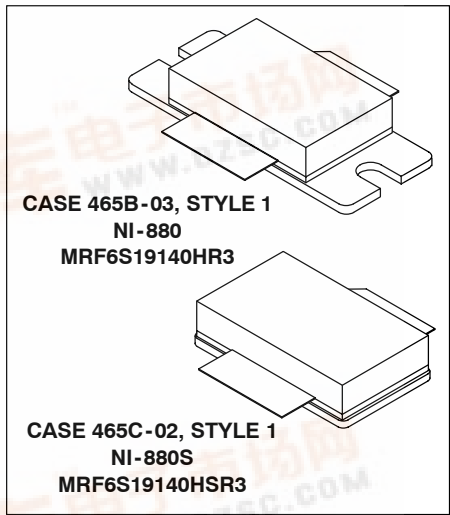
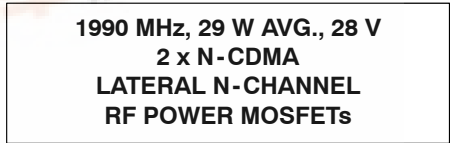
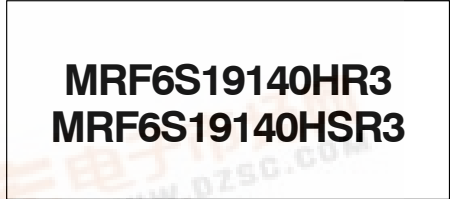

Table 1. Maximum Ratings

Rating	Symbol	Value	Unit
Drain-Source Voltage	V_{DSS}	-0.5, +68	Vdc
Gate-Source Voltage	V_{GS}	-0.5, +12	Vdc
Total Device Dissipation @ $T_C = 25^\circ\text{C}$ Derate above 25 $^\circ\text{C}$	P_D	530 3	W W/ $^\circ\text{C}$
Storage Temperature Range	T_{stg}	-65 to +150	$^\circ\text{C}$
Operating Junction Temperature	T_J	200	$^\circ\text{C}$
CW Operation	CW	140	W

Table 2. Thermal Characteristics

Characteristic	Symbol	Value (1,2)	Unit
Thermal Resistance, Junction to Case Case Temperature 80 $^\circ\text{C}$, 140 W CW Case Temperature 77 $^\circ\text{C}$, 29 W CW	$R_{\theta JC}$	0.33 0.38	$^\circ\text{C}/\text{W}$

1. MTTF calculator available at <http://www.freescale.com/rf>. Select Tools/Software/Application Software/Calculators to access the MTTF calculators by product.
2. Refer to AN1955, *Thermal Measurement Methodology of RF Power Amplifiers*. Go to <http://www.freescale.com/rf>. Select Documentation/Application Notes - AN1955.

NOTE - CAUTION - MOS devices are susceptible to damage from electrostatic charge. Reasonable precautions in handling and packaging MOS devices should be observed.



Table 3. ESD Protection Characteristics

Test Methodology	Class
Human Body Model (per JESD22-A114)	2 (Minimum)
Machine Model (per EIA/JESD22-A115)	A (Minimum)
Charge Device Model (per JESD22-C101)	IV (Minimum)

Table 4. Electrical Characteristics ($T_C = 25^\circ\text{C}$ unless otherwise noted)

Characteristic	Symbol	Min	Typ	Max	Unit
----------------	--------	-----	-----	-----	------

Off Characteristics

Zero Gate Voltage Drain Leakage Current ($V_{DS} = 68\text{ Vdc}$, $V_{GS} = 0\text{ Vdc}$)	I_{DSS}	—	—	10	μA
Zero Gate Voltage Drain Leakage Current ($V_{DS} = 28\text{ Vdc}$, $V_{GS} = 0\text{ Vdc}$)	I_{DSS}	—	—	1	μA
Gate-Source Leakage Current ($V_{GS} = 5\text{ Vdc}$, $V_{DS} = 0\text{ Vdc}$)	I_{GSS}	—	—	1	μA

On Characteristics

Gate Threshold Voltage ($V_{DS} = 10\text{ Vdc}$, $I_D = 300\ \mu\text{A}$)	$V_{GS(th)}$	1	2	3	Vdc
Gate Quiescent Voltage ($V_{DS} = 28\text{ Vdc}$, $I_D = 1150\text{ mA}$)	$V_{GS(Q)}$	2	2.8	4	Vdc
Drain-Source On-Voltage ($V_{GS} = 10\text{ Vdc}$, $I_D = 3\text{ A}$)	$V_{DS(on)}$	0.1	0.21	0.3	Vdc
Forward Transconductance ($V_{DS} = 10\text{ Vdc}$, $I_D = 3\text{ A}$)	g_{fs}	—	7.2	—	S

Dynamic Characteristics ⁽¹⁾

Reverse Transfer Capacitance ($V_{DS} = 28\text{ Vdc} \pm 30\text{ mV(rms)}$ ac @ 1 MHz, $V_{GS} = 0\text{ Vdc}$)	C_{rss}	—	2	—	pF
--	-----------	---	---	---	----

Functional Tests (In Freescale Test Fixture, 50 ohm system) $V_{DD} = 28\text{ Vdc}$, $I_{DQ} = 1150\text{ mA}$, $P_{out} = 29\text{ W Avg.}$, $f_1 = 1930\text{ MHz}$, $f_2 = 1932.5\text{ MHz}$ and $f_1 = 1987.5\text{ MHz}$, $f_2 = 1990\text{ MHz}$, 2-carrier N-CDMA, 1.2288 MHz Channel Bandwidth Carriers. ACPR measured in 30 kHz Channel Bandwidth @ $\pm 885\text{ kHz}$ Offset. IM3 measured in 1.2288 MHz Channel Bandwidth @ $\pm 2.5\text{ MHz}$ Offset. PAR = 9.8 dB @ 0.01% Probability on CCDF.

Power Gain	G_{ps}	15	16	18	dB
Drain Efficiency	η_D	26	27.5	—	%
Intermodulation Distortion	IM3	—	-37	-35	dBc
Adjacent Channel Power Ratio	ACPR	—	-51	-48	dBc
Input Return Loss	IRL	—	-15	-9	dB

1. Part is internally matched both on input and output.

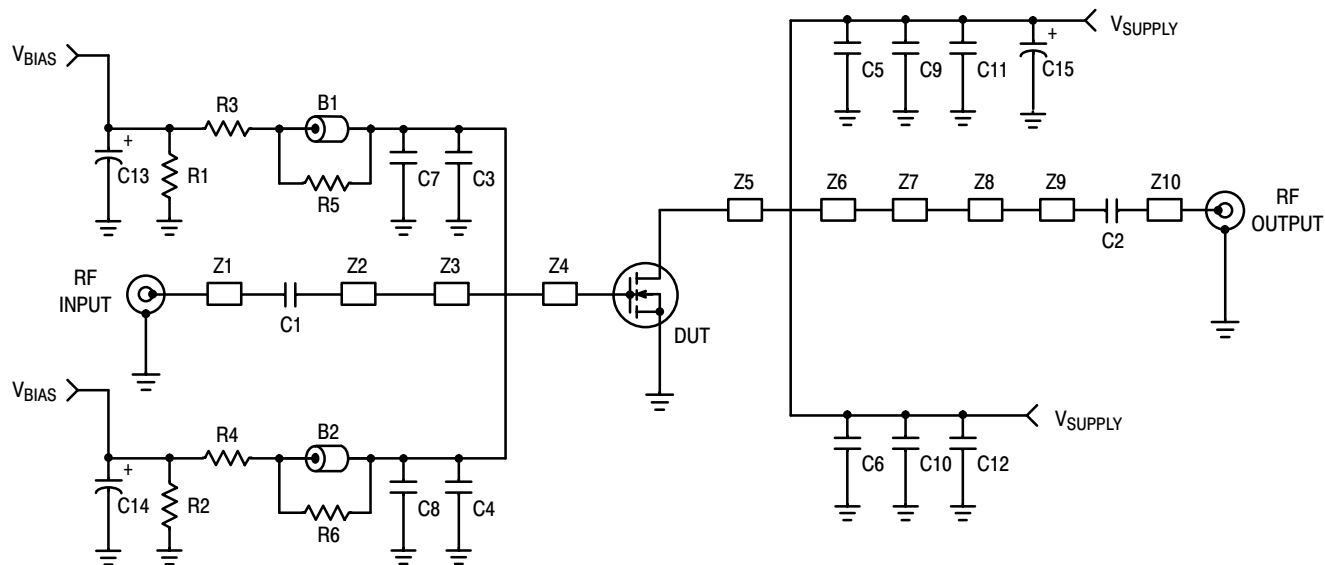

Z1 0.864" x 0.082" Microstrip
 Z2 1.373" x 0.082" Microstrip
 Z3 0.282" x 0.900" Microstrip
 Z4 0.103" x 0.900" Microstrip
 Z5 0.094" x 1.055" Microstrip
 Z6 0.399" x 1.055" Microstrip

Z7 0.115" x 0.569" Microstrip
 Z8 0.191" x 0.289" Microstrip
 Z9 0.681" x 0.081" Microstrip
 Z10 1.140" x 0.081" Microstrip
 PCB Arlon GX0300-55-22, 0.030", $\epsilon_r = 2.5$

Figure 1. MRF6S19140HR3(HSR3) Test Circuit Schematic

Table 5. MRF6S19140HR3(HSR3) Test Circuit Component Designations and Values

Part	Description	Part Number	Manufacturer
B1, B2	Beads, Surface Mount	2743019447	Fair-Rite
C1, C2	39 pF Chip Capacitors	100B390JP500X	ATC
C3, C4, C5, C6	9.1 pF Chip Capacitors	100B9R1CP500X	ATC
C7, C8, C9, C10, C11, C12	10 μ F, 50 V Chip Capacitors (2220)	GRM55DR61H106KA88B	Murata
C13, C14	47 μ F, 50 V Electrolytic Capacitors	MVK50VC47RM8X10TP	Nippon
C15	470 μ F, 63 V Electrolytic Capacitor	SME63VB471M12X25LL	United Chemi-Con
R1, R2	560 k Ω , 1/8 W Chip Resistors (1206)		Dale/Vishay
R3, R4	1.0 k Ω , 1/8 W Chip Resistors (1206)		Dale/Vishay
R5, R6	12 Ω , 1/8 W Chip Resistors (1206)		Dale/Vishay

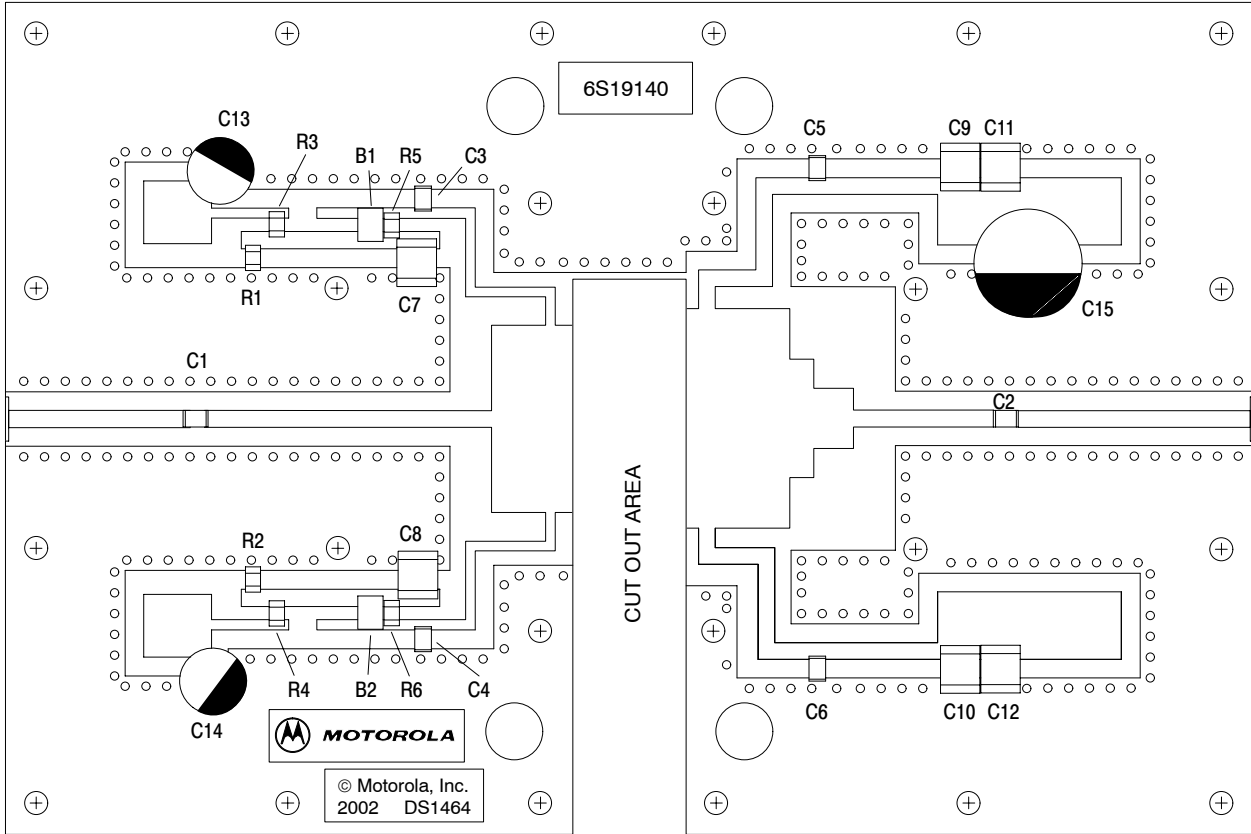

Freescale has begun the transition of marking Printed Circuit Boards (PCBs) with the Freescale Semiconductor signature/logo. PCBs may have either Motorola or Freescale markings during the transition period. These changes will have no impact on form, fit or function of the current product.

Figure 2. MRF6S19140HR3(HSR3) Test Circuit Component Layout

TYPICAL CHARACTERISTICS

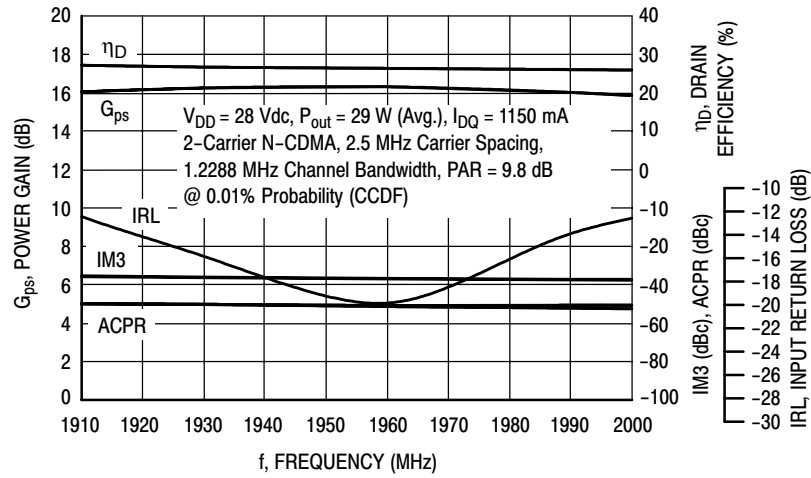

Figure 3. 2-Carrier N-CDMA Broadband Performance @ $P_{out} = 29$ Watts Avg.

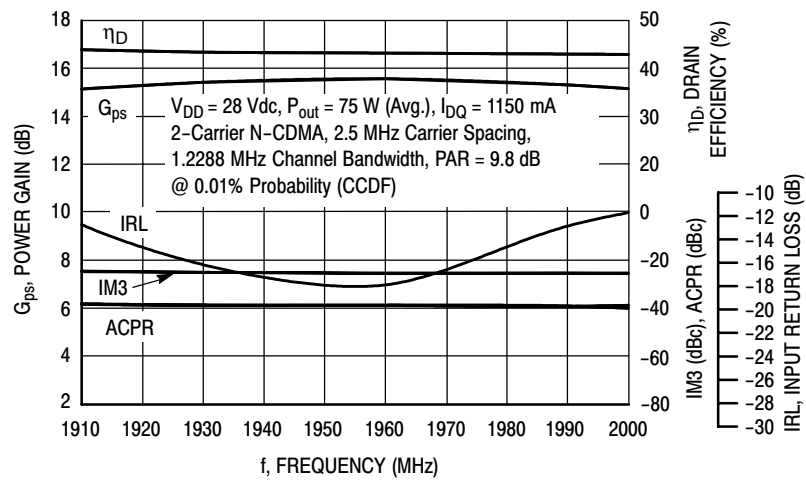

Figure 4. 2-Carrier N-CDMA Broadband Performance @ $P_{out} = 75$ Watts Avg.

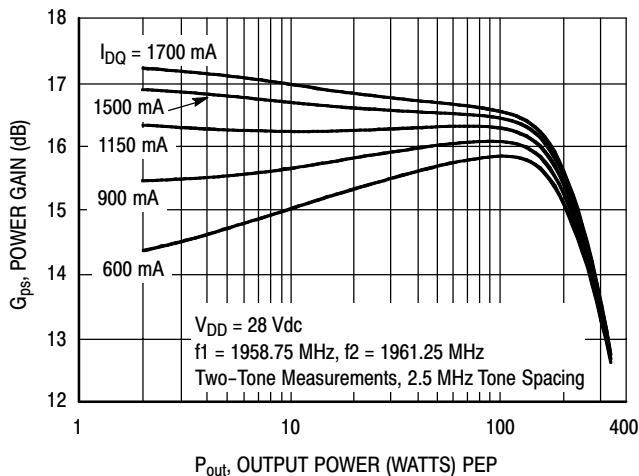

Figure 5. Two-Tone Power Gain versus Output Power

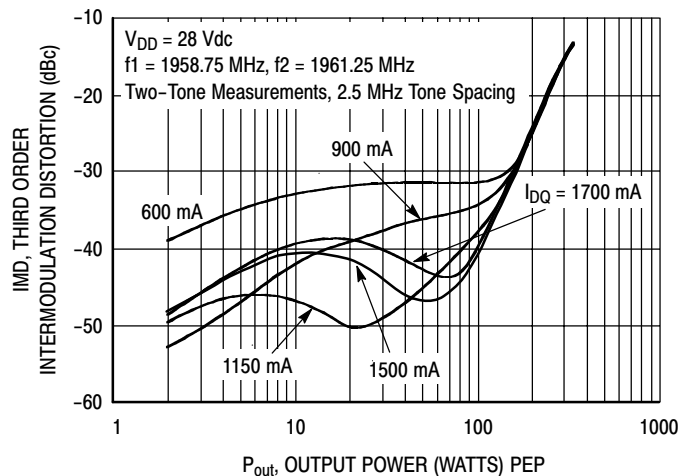

Figure 6. Third Order Intermodulation Distortion versus Output Power

TYPICAL CHARACTERISTICS

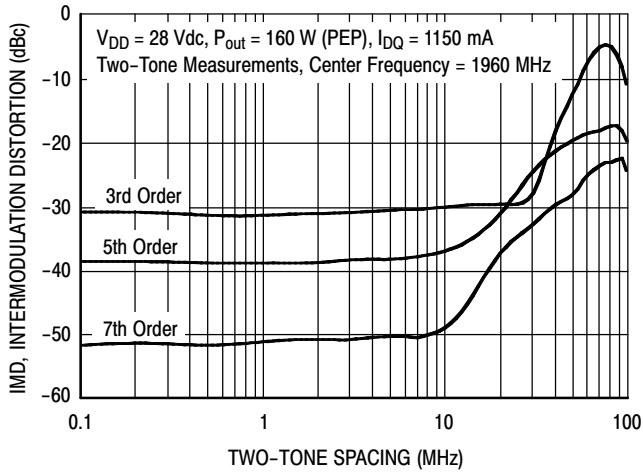

Figure 7. Intermodulation Distortion Products versus Tone Spacing

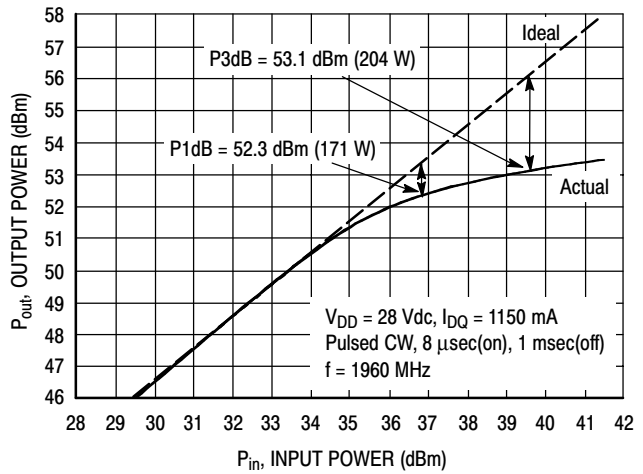

Figure 8. Pulse CW Output Power versus Input Power

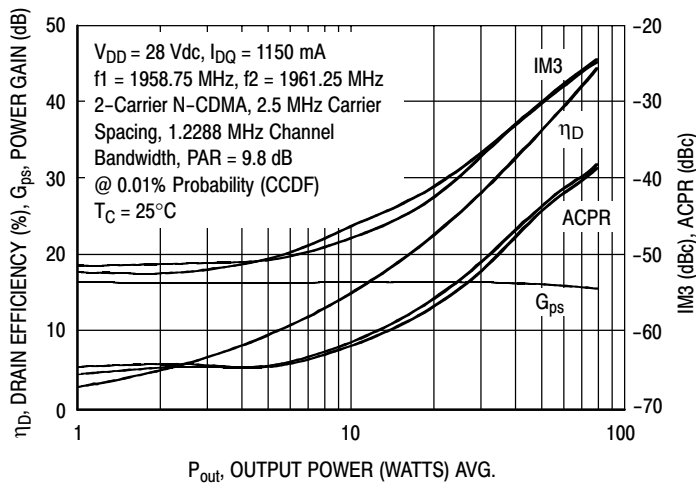

Figure 9. 2-Carrier N-CDMA ACPR, IM3, Power Gain and Drain Efficiency versus Output Power

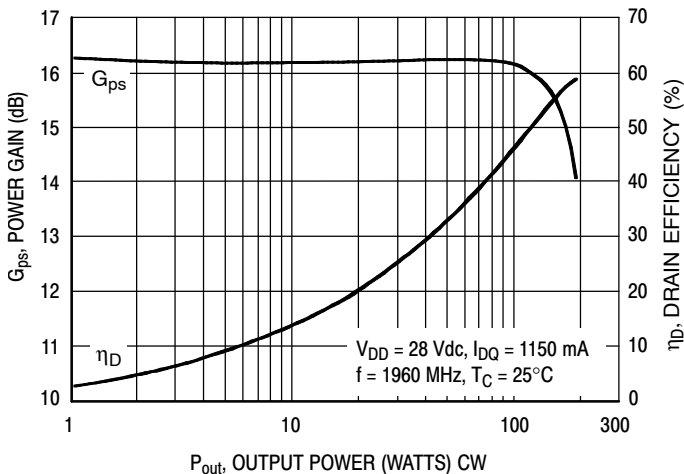

Figure 10. Power Gain and Drain Efficiency versus CW Output Power

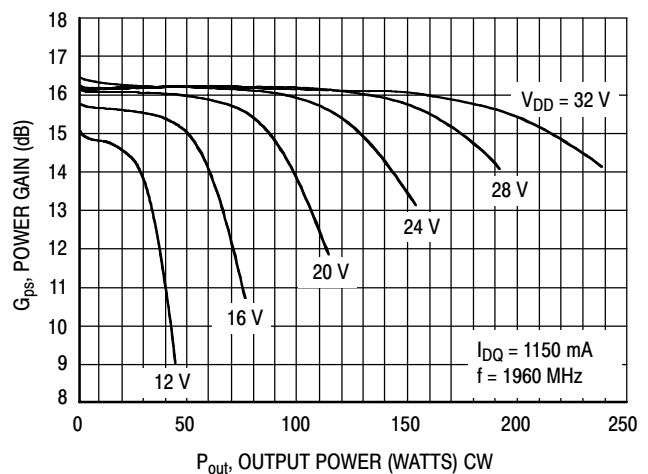
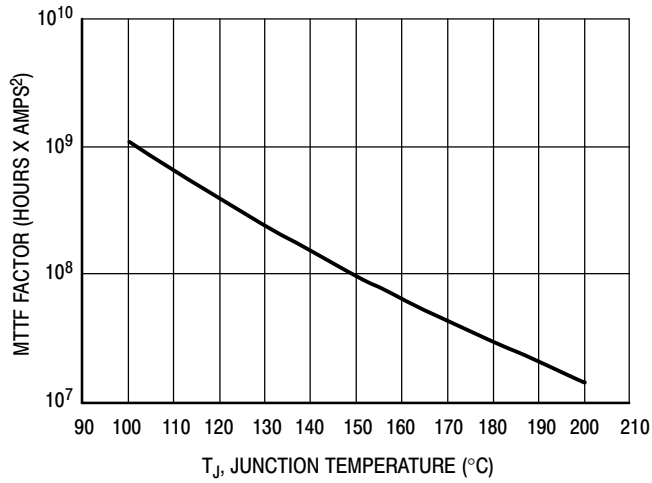

Figure 11. Power Gain versus Output Power

TYPICAL CHARACTERISTICS



This above graph displays calculated MTTF in hours x ampere² drain current. Life tests at elevated temperatures have correlated to better than $\pm 10\%$ of the theoretical prediction for metal failure. Divide MTTF factor by I_D^2 for MTTF in a particular application.

Figure 12. MTTF Factor versus Junction Temperature

N-CDMA TEST SIGNAL

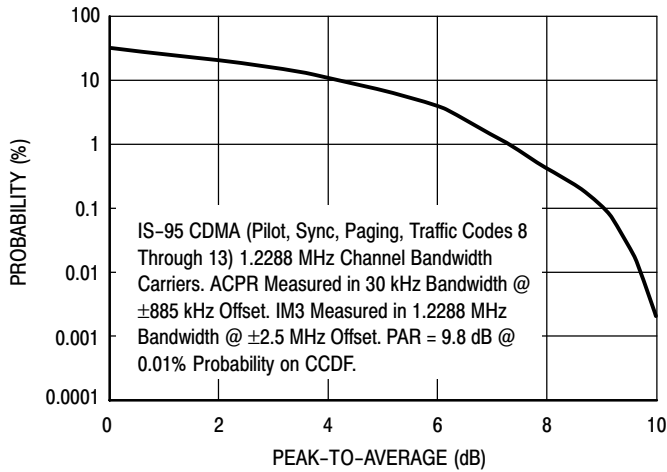

Figure 13. 2-Carrier CCDF N-CDMA

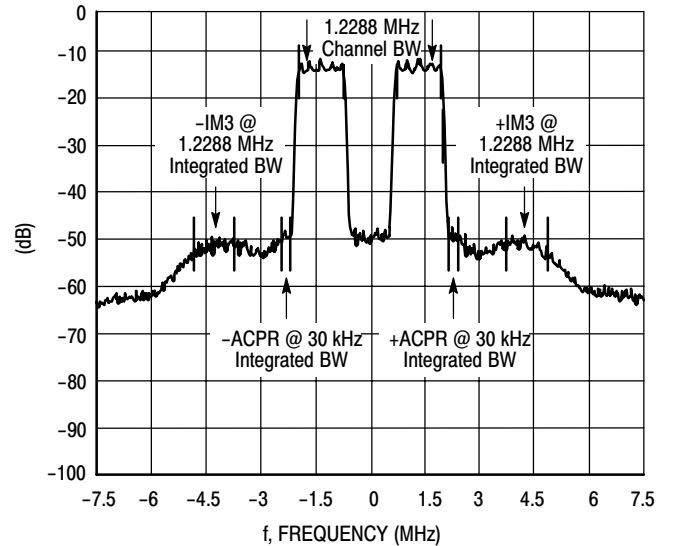
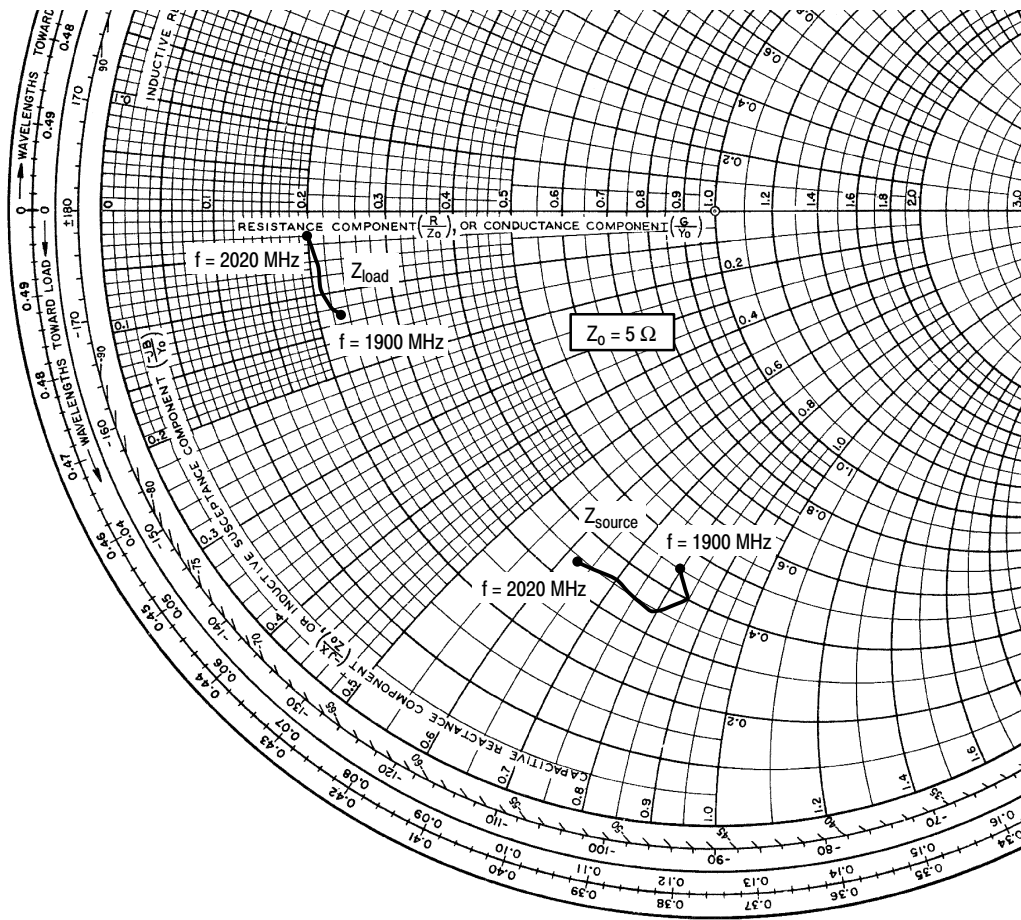

Figure 14. 2-Carrier N-CDMA Spectrum



$V_{DD} = 28 \text{ Vdc}$, $I_{DQ} = 1150 \text{ mA}$, $P_{out} = 29 \text{ W Avg.}$

f MHz	Z_{source} Ω	Z_{load} Ω
1900	$2.27 - j3.95$	$1.13 - j0.67$
1930	$2.00 - j4.24$	$1.11 - j0.60$
1960	$1.72 - j3.96$	$1.07 - j0.46$
1990	$1.80 - j3.51$	$1.06 - j0.30$
2020	$1.69 - j3.17$	$1.01 - j0.17$

Z_{source} = Test circuit impedance as measured from gate to ground.

Z_{load} = Test circuit impedance as measured from drain to ground.

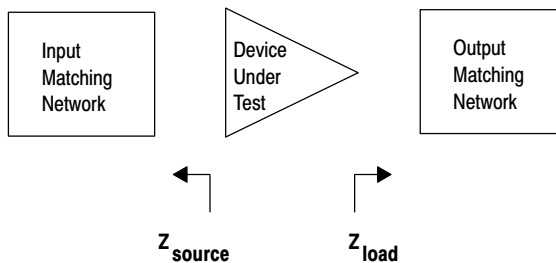

Figure 15. Series Equivalent Source and Load Impedance



NOTES



NOTES

PACKAGE DIMENSIONS

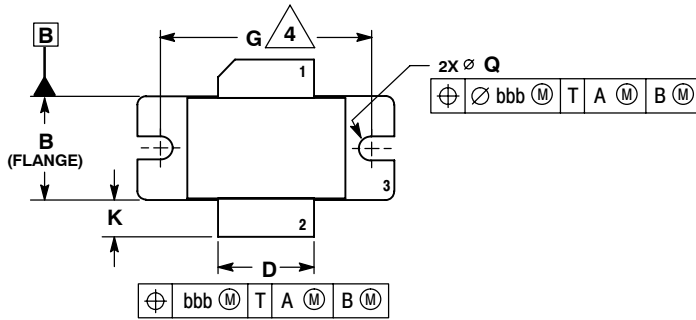

- NOTES:
1. DIMENSIONING AND TOLERANCING PER ANSI Y14.5M-1994.
 2. CONTROLLING DIMENSION: INCH.
 3. DIMENSION H IS MEASURED 0.030 (0.762) AWAY FROM PACKAGE BODY.
 4. RECOMMENDED BOLT CENTER DIMENSION OF .16 (29.57) BASED ON M3 SCREW.

DIM	INCHES		MILLIMETERS	
	MIN	MAX	MIN	MAX
A	1.335	1.345	33.91	34.16
B	0.535	0.545	13.6	13.8
C	0.147	0.200	3.73	5.08
D	0.495	0.505	12.57	12.83
E	0.035	0.045	0.89	1.14
F	0.003	0.006	0.08	0.15
G	1.100	BSC	27.94	BSC
H	0.057	0.067	1.45	1.70
K	0.175	0.205	4.44	5.21
M	0.872	0.888	22.15	22.55
N	0.871	0.889	19.30	22.60
Q	∅.118	∅.138	∅3.00	∅3.51
R	0.515	0.525	13.10	13.30
S	0.515	0.525	13.10	13.30
aaa	0.007	REF	0.178	REF
bbb	0.010	REF	0.254	REF
ccc	0.015	REF	0.381	REF

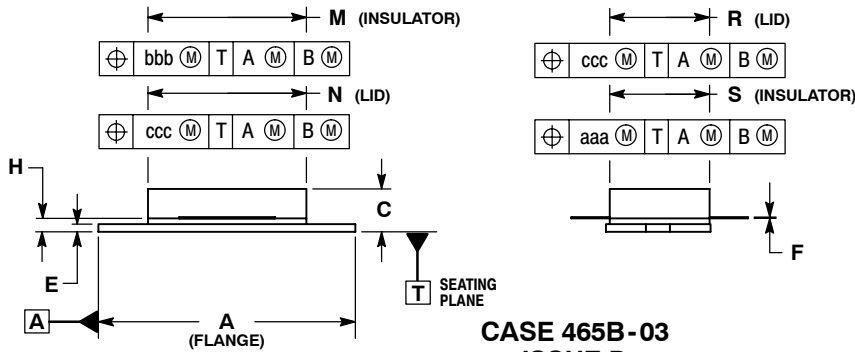

**CASE 465B-03
ISSUE D
NI-880
MRF6S19140HR3**

- STYLE 1:
PIN 1. DRAIN
2. GATE
3. SOURCE

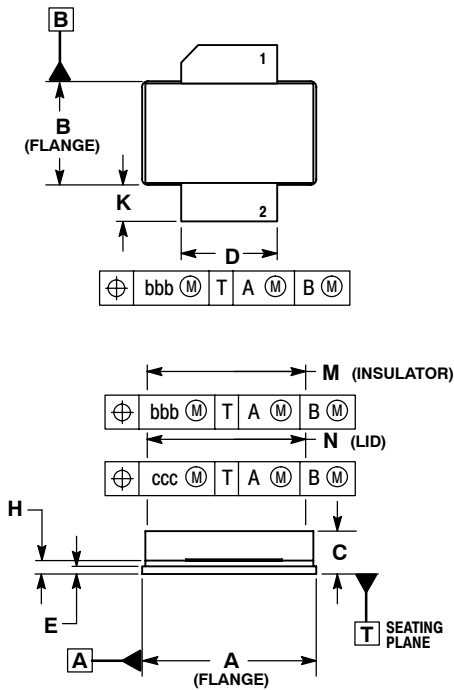

- NOTES:
1. DIMENSIONING AND TOLERANCING PER ANSI Y14.5M-1994.
 2. CONTROLLING DIMENSION: INCH.
 3. DIMENSION H IS MEASURED 0.030 (0.762) AWAY FROM PACKAGE BODY.

DIM	INCHES		MILLIMETERS	
	MIN	MAX	MIN	MAX
A	0.905	0.915	22.99	23.24
B	0.535	0.545	13.60	13.80
C	0.147	0.200	3.73	5.08
D	0.495	0.505	12.57	12.83
E	0.035	0.045	0.89	1.14
F	0.003	0.006	0.08	0.15
H	0.057	0.067	1.45	1.70
K	0.170	0.210	4.32	5.33
M	0.872	0.888	22.15	22.55
N	0.871	0.889	19.30	22.60
R	0.515	0.525	13.10	13.30
S	0.515	0.525	13.10	13.30
aaa	0.007	REF	0.178	REF
bbb	0.010	REF	0.254	REF
ccc	0.015	REF	0.381	REF

- STYLE 1:
PIN 1. DRAIN
2. GATE
3. SOURCE

**CASE 465C-02
ISSUE D
NI-880S
MRF6S19140HSR3**

How to Reach Us:

Home Page:

www.freescale.com

E-mail:

support@freescale.com

USA/Europe or Locations Not Listed:

Freescale Semiconductor
Technical Information Center, CH370
1300 N. Alma School Road
Chandler, Arizona 85224
+1-800-521-6274 or +1-480-768-2130
support@freescale.com

Europe, Middle East, and Africa:

Freescale Halbleiter Deutschland GmbH
Technical Information Center
Schatzbogen 7
81829 Muenchen, Germany
+44 1296 380 456 (English)
+46 8 52200080 (English)
+49 89 92103 559 (German)
+33 1 69 35 48 48 (French)
support@freescale.com

Japan:

Freescale Semiconductor Japan Ltd.
Headquarters
ARCO Tower 15F
1-8-1, Shimo-Meguro, Meguro-ku,
Tokyo 153-0064
Japan
0120 191014 or +81 3 5437 9125
support.japan@freescale.com

Asia/Pacific:

Freescale Semiconductor Hong Kong Ltd.
Technical Information Center
2 Dai King Street
Tai Po Industrial Estate
Tai Po, N.T., Hong Kong
+800 2666 8080
support.asia@freescale.com

For Literature Requests Only:

Freescale Semiconductor Literature Distribution Center
P.O. Box 5405
Denver, Colorado 80217
1-800-441-2447 or 303-675-2140
Fax: 303-675-2150
LDCForFreescaleSemiconductor@hibbertgroup.com

Information in this document is provided solely to enable system and software implementers to use Freescale Semiconductor products. There are no express or implied copyright licenses granted hereunder to design or fabricate any integrated circuits or integrated circuits based on the information in this document.

Freescale Semiconductor reserves the right to make changes without further notice to any products herein. Freescale Semiconductor makes no warranty, representation or guarantee regarding the suitability of its products for any particular purpose, nor does Freescale Semiconductor assume any liability arising out of the application or use of any product or circuit, and specifically disclaims any and all liability, including without limitation consequential or incidental damages. "Typical" parameters that may be provided in Freescale Semiconductor data sheets and/or specifications can and do vary in different applications and actual performance may vary over time. All operating parameters, including "Typicals", must be validated for each customer application by customer's technical experts. Freescale Semiconductor does not convey any license under its patent rights nor the rights of others. Freescale Semiconductor products are not designed, intended, or authorized for use as components in systems intended for surgical implant into the body, or other applications intended to support or sustain life, or for any other application in which the failure of the Freescale Semiconductor product could create a situation where personal injury or death may occur. Should Buyer purchase or use Freescale Semiconductor products for any such unintended or unauthorized application, Buyer shall indemnify and hold Freescale Semiconductor and its officers, employees, subsidiaries, affiliates, and distributors harmless against all claims, costs, damages, and expenses, and reasonable attorney fees arising out of, directly or indirectly, any claim of personal injury or death associated with such unintended or unauthorized use, even if such claim alleges that Freescale Semiconductor was negligent regarding the design or manufacture of the part.

Freescale™ and the Freescale logo are trademarks of Freescale Semiconductor, Inc. All other product or service names are the property of their respective owners.
© Freescale Semiconductor, Inc. 2005. All rights reserved.

