



CY6264

8K x 8 Static RAM

Features

- 55, 70 ns access times
- CMOS for optimum speed/power
- Easy memory expansion with \overline{CE}_1 , CE_2 , and \overline{OE} features
- TTL-compatible inputs and outputs
- Automatic power-down when deselected

Functional Description

The CY6264 is a high-performance CMOS static RAM organized as 8192 words by 8 bits. Easy memory expansion is provided by an active LOW chip enable (\overline{CE}_1), an active HIGH chip enable (CE_2), and active LOW output enable (\overline{OE}) and three-state drivers. Both devices have an automatic

power-down feature (\overline{CE}_1), reducing the power consumption by over 70% when deselected. The CY6264 is packaged in a 450-mil (300-mil body) SOIC.

An active LOW write enable signal (\overline{WE}) controls the writing/reading operation of the memory. When \overline{CE}_1 and \overline{WE} inputs are both LOW and CE_2 is HIGH, data on the eight data input/output pins (I/O_0 through I/O_7) is written into the memory location addressed by the address present on the address pins (A_0 through A_{12}). Reading the device is accomplished by selecting the device and enabling the outputs, \overline{CE}_1 and \overline{OE} active LOW, CE_2 active HIGH, while \overline{WE} remains inactive or HIGH. Under these conditions, the contents of the location addressed by the information on address pins is present on the eight data input/output pins.

The input/output pins remain in a high-impedance state unless the chip is selected, outputs are enabled, and write enable (\overline{WE}) is HIGH. A die coat is used to insure alpha immunity.

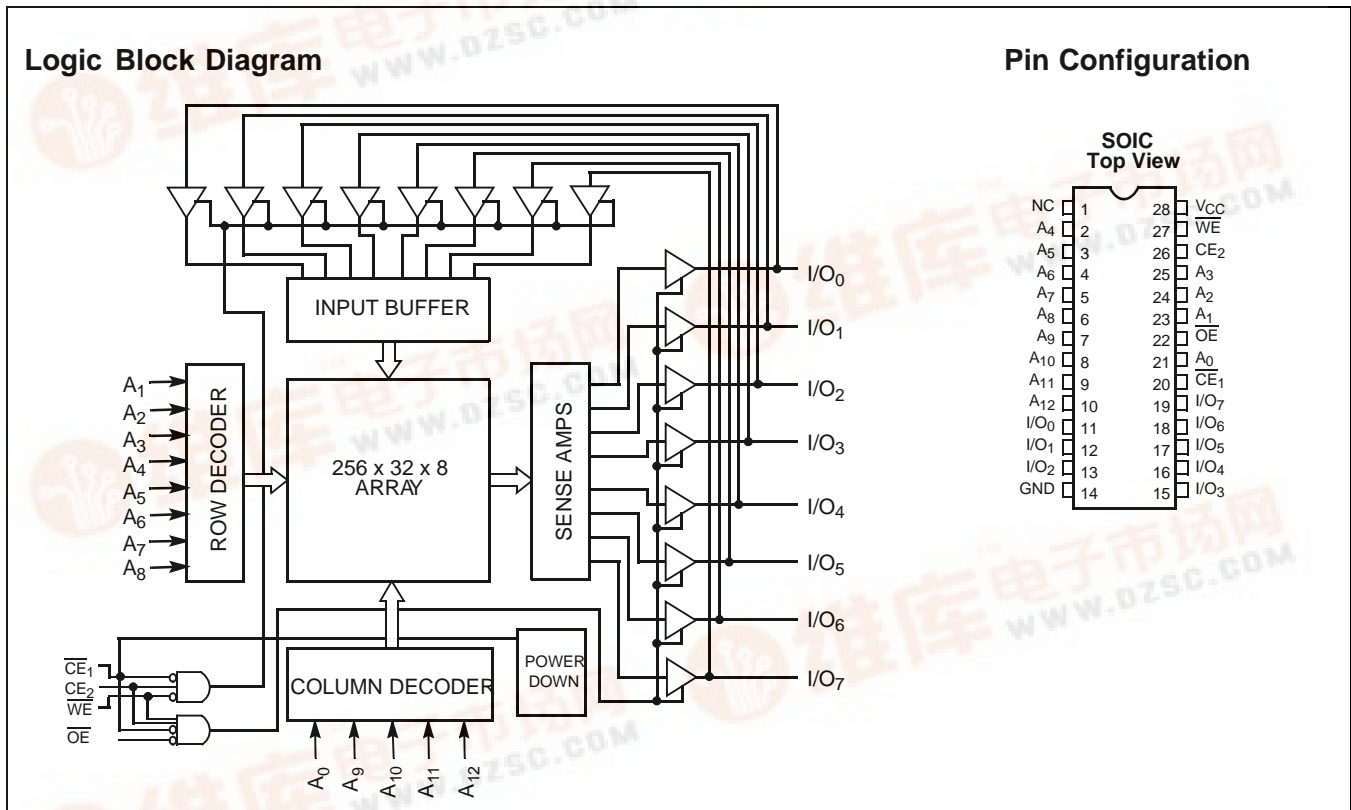



Selection Guide

		CY6264-55	CY6264-70	Unit
Maximum Access Time		55	70	ns
Maximum Operating Current	Commercial	100	100	mA
	Industrial		200	
Maximum Standby Current	Commercial	20/15	20/15	mA
	Industrial		30	

Shaded areas contain advance information.

Maximum Ratings

(Above which the useful life may be impaired. For user guidelines, not tested.)

- Storage Temperature -65°C to +150°C
- Ambient Temperature with Power Applied -55°C to +125°C
- Supply Voltage to Ground Potential -0.5V to +7.0V
- DC Voltage Applied to Outputs in High Z State^[1] -0.5V to +7.0V
- DC Input Voltage^[1] -0.5V to +7.0V

- Output Current into Outputs (LOW) 20 mA
- Static Discharge Voltage >2001V (per MIL-STD-883, Method 3015)
- Latch-Up Current >200 mA

Operating Range

Range	Ambient Temperature	V _{CC}
Commercial	0°C to +70°C	5V ± 10%
Industrial	-40°C to +85°C	

Electrical Characteristics Over the Operating Range

Parameter	Description	Test Conditions	6264-55		6264-70		Unit
			Min.	Max.	Min.	Max.	
V _{OH}	Output HIGH Voltage	V _{CC} = Min., I _{OH} = -4.0 mA	2.4		2.4		V
V _{OL}	Output LOW Voltage	V _{CC} = Min., I _{OL} = 8.0 mA		0.4		0.4	V
V _{IH}	Input HIGH Voltage		2.2	V _{CC}	2.2	V _{CC}	V
V _{IL}	Input LOW Voltage ^[1]		-0.5	0.8	-0.5	0.8	V
I _{IX}	Input Load Current	GND ≤ V _I ≤ V _{CC}	-5	+5	-5	+5	μA
I _{OZ}	Output Leakage Current	GND ≤ V _I ≤ V _{CC} , Output Disabled	-5	+5	-5	+5	μA
I _{OS}	Output Short Circuit Current ^[2]	V _{CC} = Max., V _{OUT} = GND		-300		-300	mA
I _{CC}	V _{CC} Operating Supply Current	V _{CC} = Max., I _{OUT} = 0 mA	Com'l	100		100	mA
			Ind'l			200	
I _{SB1}	Automatic \overline{CE}_1 Power-Down Current	Max. V _{CC} , $\overline{CE}_1 \geq V_{IH}$, Min. Duty Cycle=100%	Com'l	20		20	mA
			Ind'l			40	
I _{SB2}	Automatic \overline{CE}_1 Power-Down Current	Max. V _{CC} , $\overline{CE}_1 \geq V_{CC} - 0.3V$, V _{IN} ≥ V _{CC} - 0.3V or V _{IN} ≤ 0.3V	Com'l	15		15	mA
			Ind'l			30	

Shaded areas contain advance information.

Notes:

1. Minimum voltage is equal to -3.0V for pulse durations less than 30 ns.
2. Not more than 1 output should be shorted at one time. Duration of the short circuit should not exceed 30 seconds.

Switching Characteristics Over the Operating Range^[3]

Parameter	Description	6264-55		6264-70		Unit
		Min.	Max.	Min.	Max.	
READ CYCLE						
t _{RC}	Read Cycle Time	55		70		ns
t _{AA}	Address to Data Valid		55		70	ns
t _{OHA}	Data Hold from Address Change	5		5		ns
t _{ACE1}	\overline{CE}_1 LOW to Data Valid		55		70	ns
t _{ACE2}	CE ₂ HIGH to Data Valid		40		70	ns
t _{DOE}	\overline{OE} LOW to Data Valid		25		35	ns
t _{LZOE}	\overline{OE} LOW to Low Z	3		5		ns
t _{HZOE}	\overline{OE} HIGH to High Z ^[4]		20		30	ns
t _{LZCE1}	\overline{CE}_1 LOW to Low Z ^[5]	5		5		ns
t _{LZCE2}	CE ₂ HIGH to Low Z	3		5		ns
t _{HZCE}	\overline{CE}_1 HIGH to High Z ^[4, 5] CE ₂ LOW to High Z		20		30	ns
t _{PU}	\overline{CE}_1 LOW to Power-Up	0		0		ns
t _{PD}	\overline{CE}_1 HIGH to Power-Down		25		30	ns
WRITE CYCLE^[6]						
t _{WC}	Write Cycle Time	50		70		ns
t _{SCE1}	\overline{CE}_1 LOW to Write End	40		60		ns
t _{SCE2}	CE ₂ HIGH to Write End	30		50		ns
t _{AW}	Address Set-Up to Write End	40		55		ns
t _{HA}	Address Hold from Write End	0		0		ns
t _{SA}	Address Set-Up to Write Start	0		0		ns
t _{PWE}	\overline{WE} Pulse Width	25		40		ns
t _{SD}	Data Set-Up to Write End	25		35		ns
t _{HD}	Data Hold from Write End	0		0		ns
t _{HZWE}	\overline{WE} LOW to High Z ^[4]		20		30	ns
t _{LZWE}	\overline{WE} HIGH to Low Z	5		5		ns

Shaded areas contain advance information.

Capacitance^[7]

Parameter	Description	Test Conditions	Max.	Unit
C _{IN}	Input Capacitance	T _A = 25°C, f = 1 MHz, V _{CC} = 5.0V	7	pF
C _{OUT}	Output Capacitance		7	pF

Notes:

- Test conditions assume signal transition time of 5 ns or less, timing reference levels of 1.5V, input pulse levels of 0 to 3.0V, and output loading of the specified I_{OL}/I_{OH} and 30-pF load capacitance.
- t_{HZOE}, t_{HZCE}, and t_{HZWE} are specified with C_L = 5 pF as in part (b) of AC Test Loads. Transition is measured ±500 mV from steady-state voltage.
- At any given temperature and voltage condition, t_{HZCE} is less than t_{LZCE} for any given device.
- The internal write time of the memory is defined by the overlap of CE₁ LOW, CE₂ HIGH, and \overline{WE} LOW. Both signals must be LOW to initiate a write and either signal can terminate a write by going HIGH. The data input set-up and hold timing should be referenced to the rising edge of the signal that terminates the write.
- Tested initially and after any design or process changes that may affect these parameters.

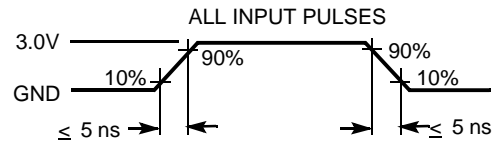
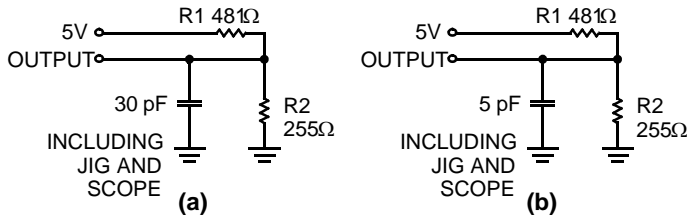
AC Test Loads and Waveforms

Equivalent to: THÉVENIN EQUIVALENT

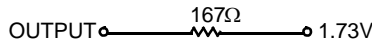
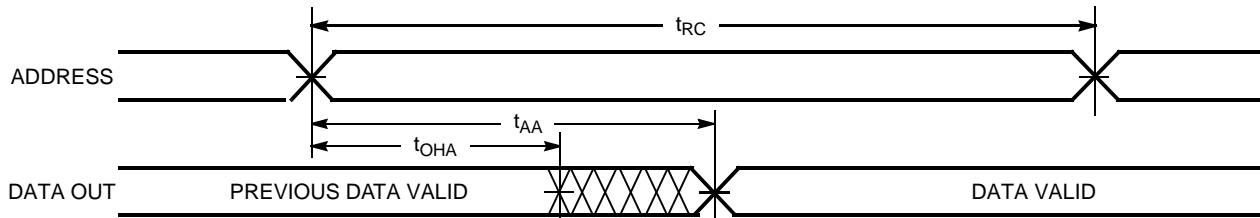
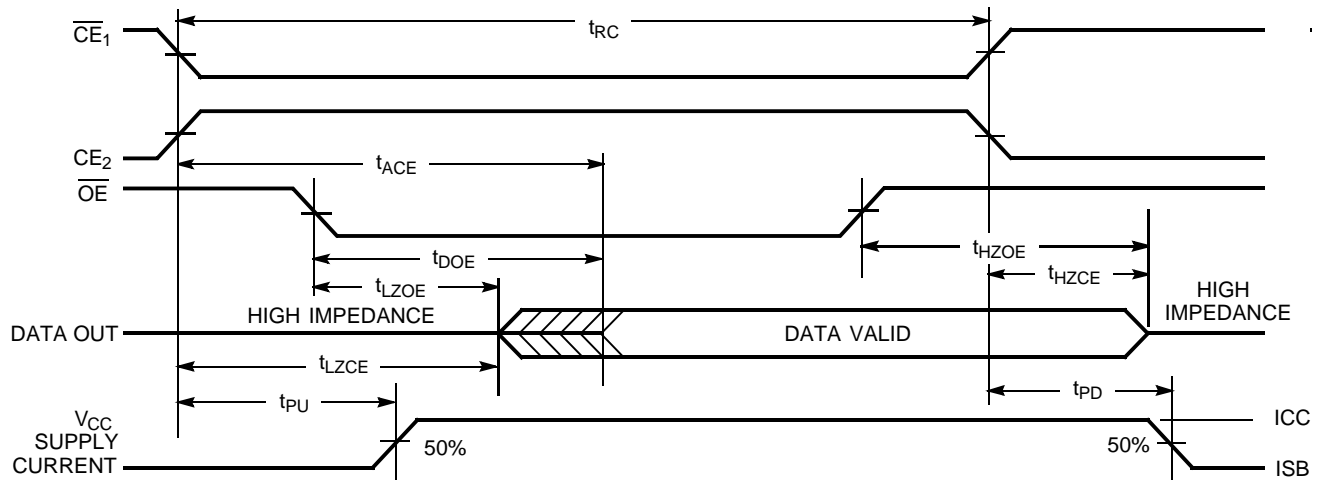
Switching Waveforms
Read Cycle No. 1^[8, 9]

Read Cycle No. 2^[10, 11]

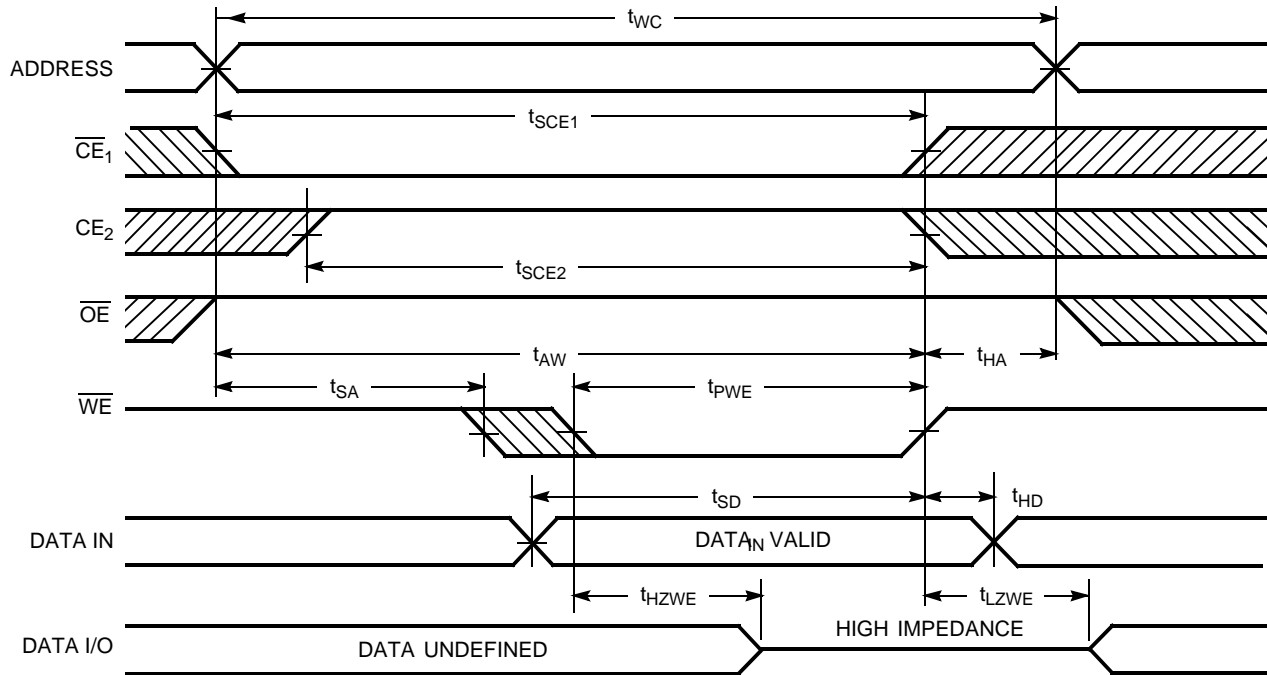
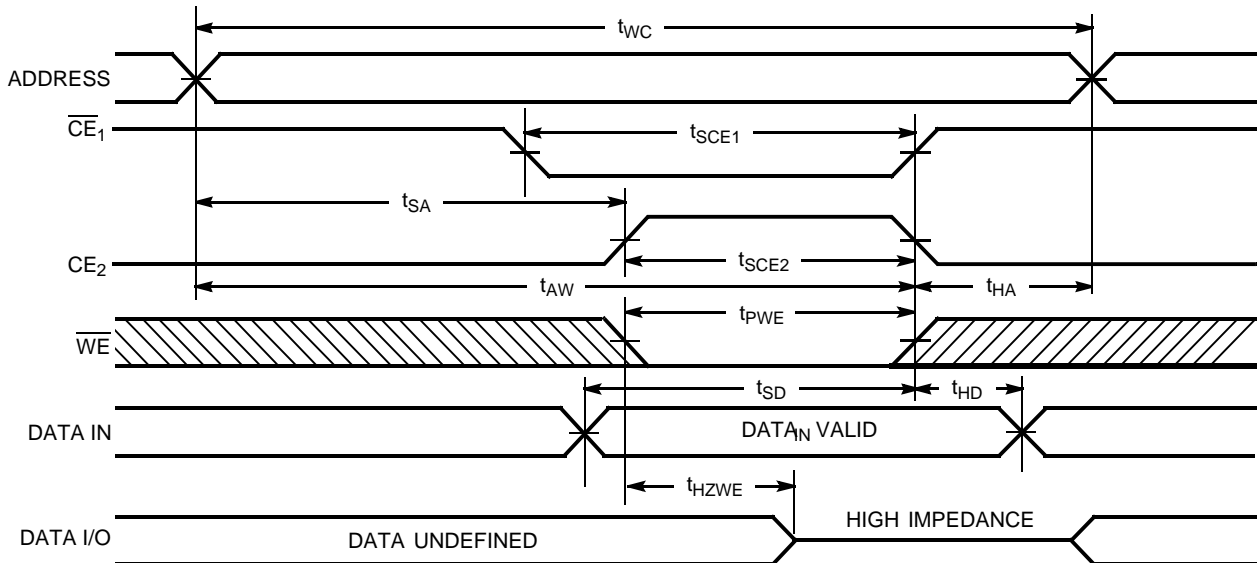
Notes:

8. Device is continuously selected. \overline{OE} , $\overline{CE} = V_{IL}$. $CE_2 = V_{IH}$.
9. Address valid prior to or coincident with \overline{CE} transition LOW.
10. \overline{WE} is HIGH for read cycle.
11. Data I/O is High Z if $\overline{OE} = V_{IH}$, $\overline{CE}_1 = V_{IH}$, or $\overline{WE} = V_{IL}$.

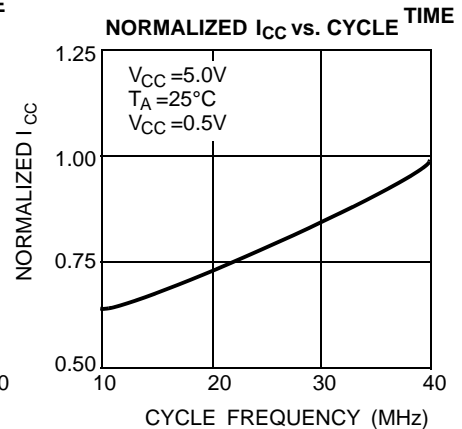
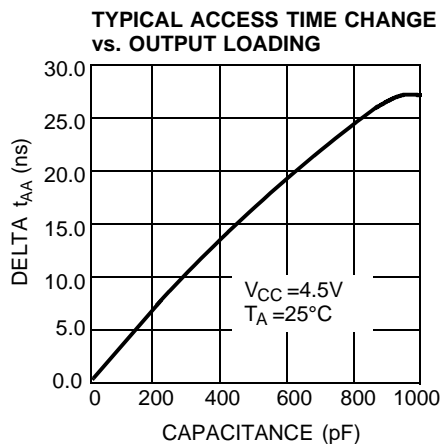
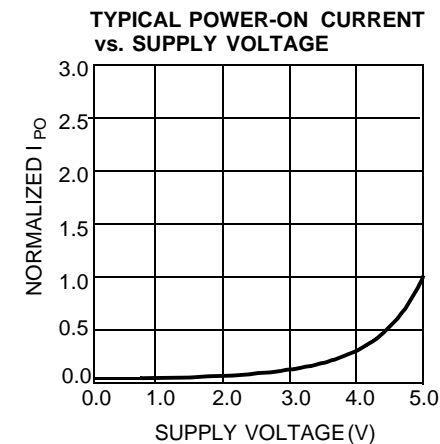
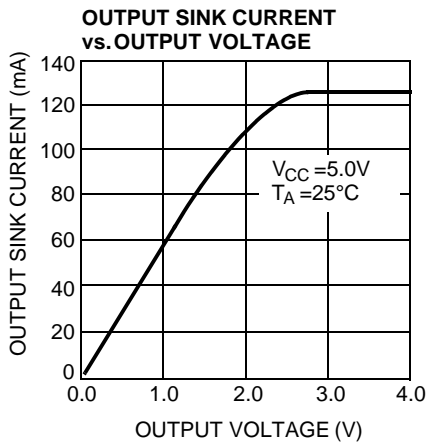
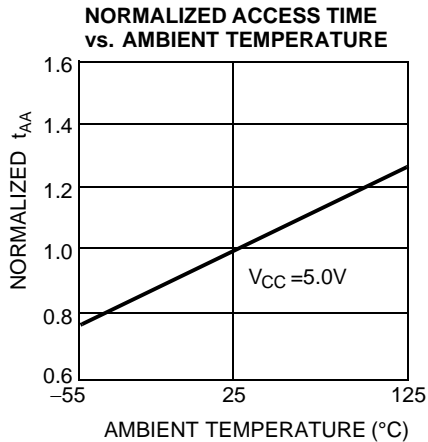
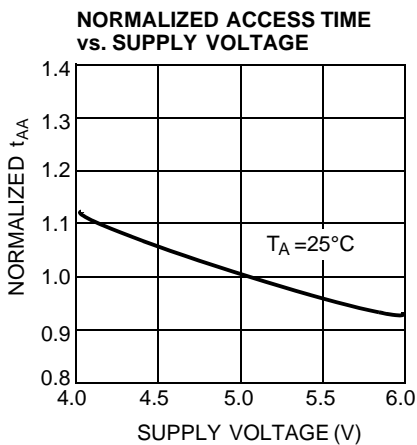
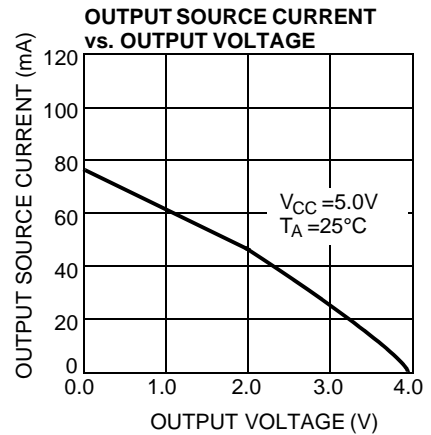
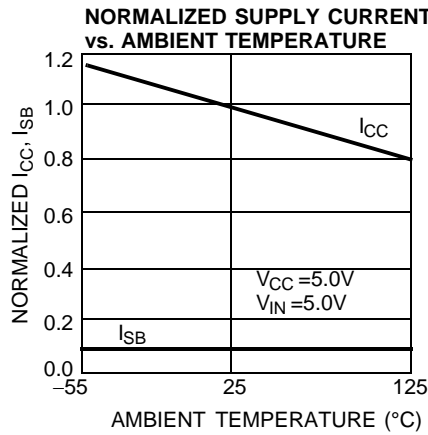
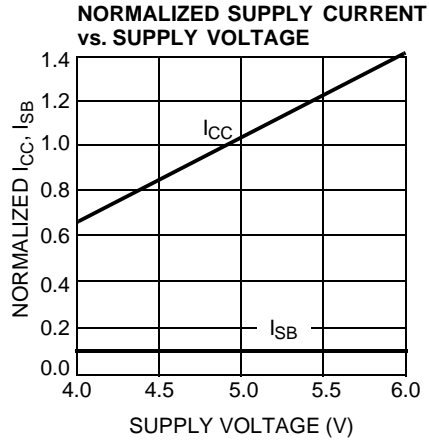
Switching Waveforms (continued)
Write Cycle No. 1 (WE Controlled)^[9, 11]

Write Cycle No. 2 (\overline{CE} Controlled)^[9, 11, 12]

Note:
 12. If \overline{CE} goes HIGH simultaneously with \overline{WE} HIGH, the output remains in a high-impedance state.

Typical DC and AC Characteristics

Truth Table

\overline{CE}_1	CE_2	\overline{WE}	\overline{OE}	Input/Output	Mode
H	X	X	X	High Z	Deselect/Power-Down
X	L	X	X	High Z	Deselect
L	H	H	L	Data Out	Read
L	H	L	X	Data In	Write
L	H	H	H	High Z	Deselect

Address Designators

Address Name	Address Function	Pin Number
A4	X3	2
A5	X4	3
A6	X5	4
A7	X6	5
A8	X7	6
A9	Y1	7
A10	Y4	8
A11	Y3	9
A12	Y0	10
A0	Y2	21
A1	X0	23
A2	X1	24
A3	X2	25

Ordering Information

Speed (ns)	Ordering Code	Package Name	Package Type	Operating Range
55	CY6264-55SC	S28.33	28-Lead 330-Mil SOIC ^[13]	Commercial
70	CY6264-70SC	S28.33	28-Lead 330-Mil SOIC ^[13]	Commercial
55	CY6264-55SNC	SN28	28-Lead 300-Mil SOIC	Commercial
55	CY6264-55SNXC	SN28	28-Lead 300-Mil SOIC (Pb-free)	Commercial
70	CY6264-70SNC	SN28	28-Lead 300-Mil SOIC	Commercial
70	CY6264-70SNXC	SN28	28-Lead 300-Mil SOIC (Pb-free)	Commercial
70	CY6264-70SNI	SN28	28-Lead 300-Mil SOIC	Industrial
70	CY6264-70SNXI	SN28	28-Lead 300-Mil SOIC (Pb-free)	Industrial

Shaded areas contain advance information.

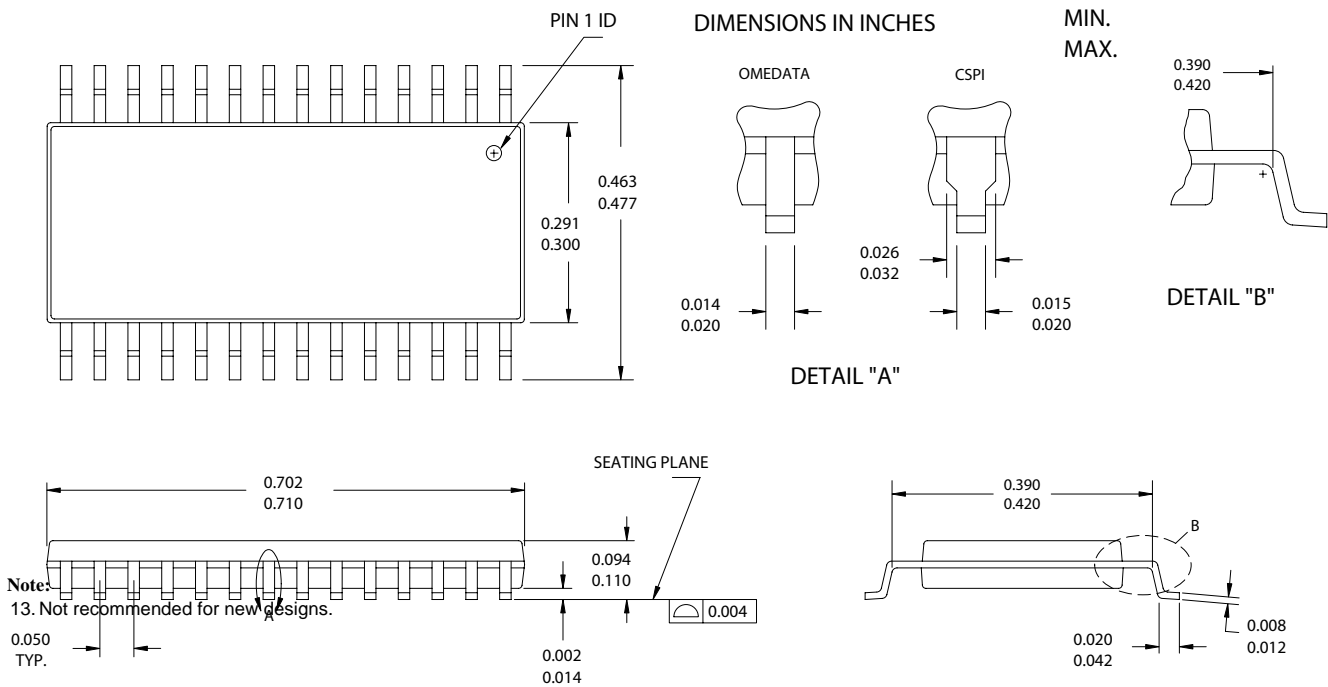
Package Diagrams
28-lead (300 mil) SNC Package Outline (Narrow Body) SN28

51-85092-*B

Package Diagrams (continued)

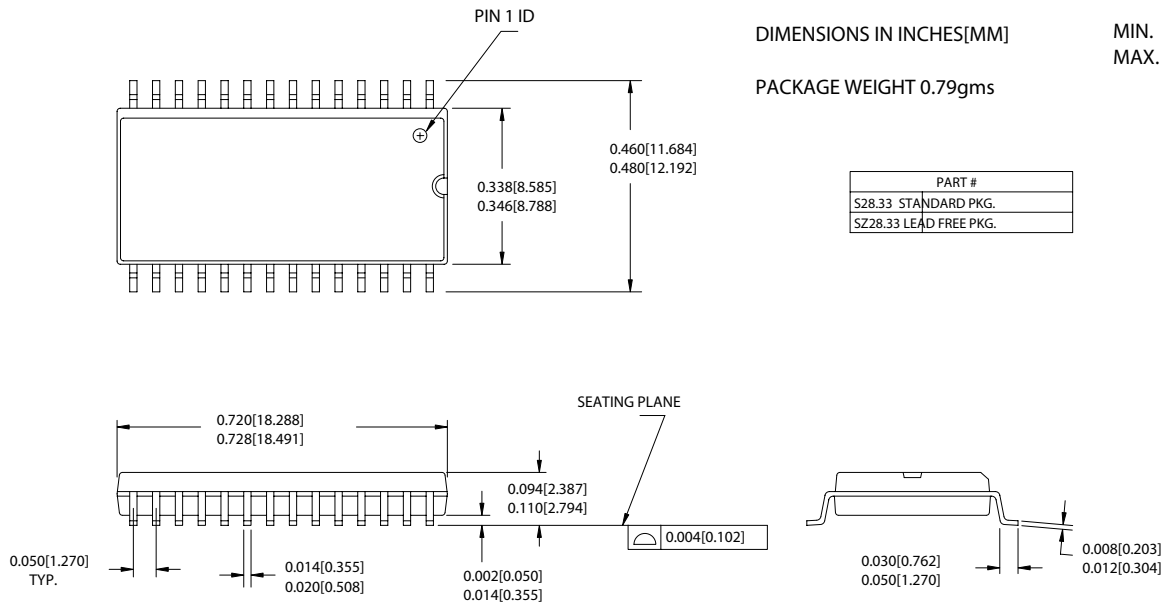
28-Lead SOIC with Wide Body S28.33

51-85058-B



Document History Page

Document Title:CY6264 8K x 8 Static RAM Document Number: 001-02367				
REV.	ECN NO.	Issue Date	Orig. of Change	Description of Change
**	384870	See ECN	PCI	Spec # change from 38-00425 to 001-02367



中发网 WWW.ZFA.CN

全球最大的PDF中文下载站



中发网
www.zfa.cn

PDF 资料下载尽在中发网