

6MBP75RTB060

IPM-R3 series

600V / 75A 6 in one-package

Features

- Temperature protection provided by directly detecting the junction temperature of the IGBTs
- Low power loss and soft switching
- High performance and high reliability IGBT with overheating protection
- Higher reliability because of a big decrease in number of parts in built-in control circuit

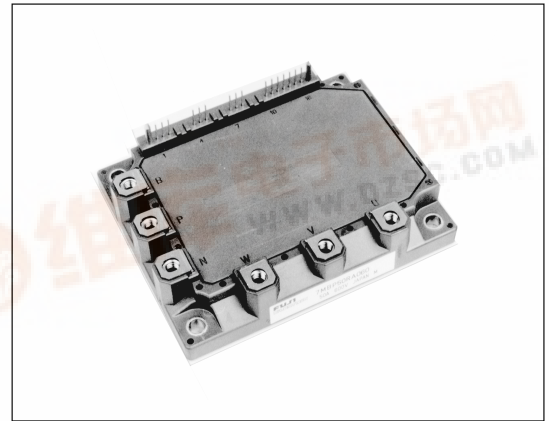

Maximum ratings and characteristics

● Absolute maximum ratings(at Tc=25°C unless otherwise specified)

Item	Symbol	Rating		Unit	
		Min.	Max.		
DC bus voltage	Vbc	0	450	V	
DC bus voltage (surge)	Vbc(surge)	0	500	V	
DC bus voltage (short operating)	Vsc	200	400	V	
Collector-Emitter voltage	Vces *1	0	600	V	
INV Collector current	DC	Ic	-	75	A
	1ms	IcP	-	150	A
	Duty=74.9%	-Ic *2	-	75	A
Collector power dissipation	One transistor	Pc *3	-	198	W
Junction temperature	Tj	-	150	°C	
Input voltage of power supply for Pre-Driver	Vcc *4	-0.5	20	V	
Input signal voltage	Vin *5	-0.5	Vcc+0.5	V	
Input signal current	Iin	-	3	mA	
Alarm signal voltage	VALM *6	-0.5	Vcc	V	
Alarm signal current	IALM *7	-	20	mA	
Storage temperature	Tstg	-40	125	°C	
Operating case temperature	Topr	-20	100	°C	
Isolating voltage (Case-Terminal)	Viso *8	-	AC2.5	kV	
Screw torque	Mounting (M5)	-	3.5 *9	N·m	
	Terminal (M5)	-	3.5 *9	N·m	

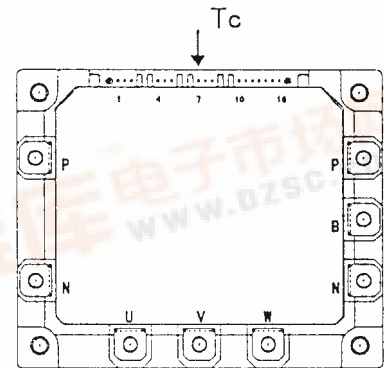

Fig.1 Measurement of case temperature

*1 : Vces shall be applied to the input voltage between terminal P and U or V or W, N and U or V or W.

*2 : $125^{\circ}\text{C}/\text{FWD } R_{\text{th}}(\text{j-c})/(\text{Ic} \times \text{Vf MAX})=125/0.855/(75 \times 2.6) \times 100=74.9\%$

*3 : $P_c=125^{\circ}\text{C}/\text{IGBT } R_{\text{th}}(\text{j-c})=125/0.63=198\text{W}$ [Inverter]

*4 : Vcc shall be applied to the input voltage between terminal No. 3 and 1, 6 and 4, 9 and 7, 11 and 10.

*5 : Vin shall be applied to the input voltage between terminal No. 2 and 1, 5 and 4, 8 and 7, 13,14,15 and 10.

*6 : VALM shall be applied to the voltage between terminal No. 16 and 10.

*7 : IALM shall be applied to the input current to terminal No. 16.

*8 : 50Hz/60Hz sine wave 1 minute.

*9 : Recommendable Value : 2.5 to 3.0 N·m

6MBP75RTB060

IGBT-IPM

● Electrical characteristics (at Tc=Tj=25°C, Vcc=15V unless otherwise specified.)

Main circuit

Item	Symbol	Condition	Min.	Typ.	Max.	Unit		
INV	Collector current at off signal input	ICES	VCE=600V Vin terminal open.	-	-	1.0	mA	
	Collector-Emitter saturation voltage	VCE(sat)	Ic=75A	Terminal	-	-	2.4	V
				Chip	-	2.0	-	
	Forward voltage of FWD	VF	-Ic=75A	Terminal	-	-	2.6	V
Chip				-	1.6	-		
Turn-on time	ton	VDC=300V, Tj=125°C	1.2	-	-	μs		
Turn-off time	toff	Ic=75A Fig.1, Fig.6	-	-	3.6			
Reverse recovery time	trr	VDC=300V, Ic=75A Fig.1, Fig.6	-	-	0.3			
Maximum Avalanche Energy (A non-repetition)	PAV	Internal wiring inductance=50nH Main circuit wiring inductance=54nH	40	-	-	mJ		

● Control circuit

Item	Symbol	Condition	Min.	Typ.	Max.	Unit
Supply current of P-line side pre-driver(one unit)	Iccp	Switching Frequency : 0 to 15kHz Tc=-20 to 125°C Fig.7	-	-	18	mA
Supply current of N-line side pre-driver	Iccn		-	-	65	mA
Input signal threshold voltage (on/off)	Vin(th)	ON	1.00	1.35	1.70	V
		OFF	1.25	1.60	1.95	V
Input zener voltage	VZ	Rin=20k ohm	-	8.0	-	V
Alarm signal hold time	tALM	Tc=-20°C Fig.2	1.1	-	-	ms
		Tc=25°C Fig.2	-	2.0	-	ms
		Tc=125°C Fig.2	-	-	4.0	ms
Limiting resistor for alarm	RALM		1425	1500	1575	ohm

● Protection Section (Vcc=15V)

Item	Symbol	Condition	Min.	Typ.	Max.	Unit
Over Current Protection Level of Inverter circuit	Ioc	Tj=125°C	113	-	-	A
Over Current Protection Delay time	tDOC	Tj=125°C	-	5	-	μs
SC Protection Delay time	tSC	Tj=125°C Fig.4	-	-	8	μs
IGBT Chip Over Heating	TjOH	surface of IGBT chips	150	-	-	°C
Over Heating Protection Hysteresis	TjH	VDC=0V, Ic=0A, Case temperature	-	20	-	°C
Over Heating Protection Temperature Level	TcOH		110	-	125	°C
Over Heating Protection Hysteresis	TcH		-	20	-	
Under Voltage Protection Level	VUV		11.0	-	12.5	V
Under Voltage Protection Hysteresis	VH		0.2	0.5	-	

● Thermal characteristics(Tc=25°C)

Item	Symbol	Min.	Typ.	Max.	Unit		
Junction to Case thermal resistance	INV	IGBT	Rth(j-c)	-	-	0.63	°C/W
		FWD	Rth(j-c)	-	-	0.855	°C/W
Case to fin thermal resistance with compound		Rth(c-f)	-	0.05	-	°C/W	

● Noise Immunity (VDC=300V, Vcc=15V, Test Circuit Fig.5)

Item	Condition	Min.	Typ.	Max.	Unit
Common mode rectangular noise	Pulse width 1μs, polarity ±, 10minuets Judge : no over-current, no miss operating	±2.0	-	-	kV
Common mode lightning surge	Rise time 1.2μs, Fall time 50μs Interval 20s, 10 times Judge : no over-current, no miss operating	±5.0	-	-	kV

● Recommendable value

Item	Symbol	Min.	Typ.	Max.	Unit
DC Bus Voltage	VDC	-	-	400	V
Operating Supply Voltage of Pre-Driver	VCC	13.5	15.0	16.5	V
Screw torque (M5)	-	2.5	-	3.0	Nm

● Weight

Item	Symbol	Min.	Typ.	Max.	Unit
Weight	Wt	-	450	-	g

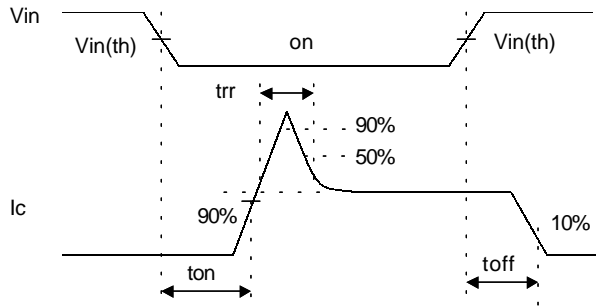
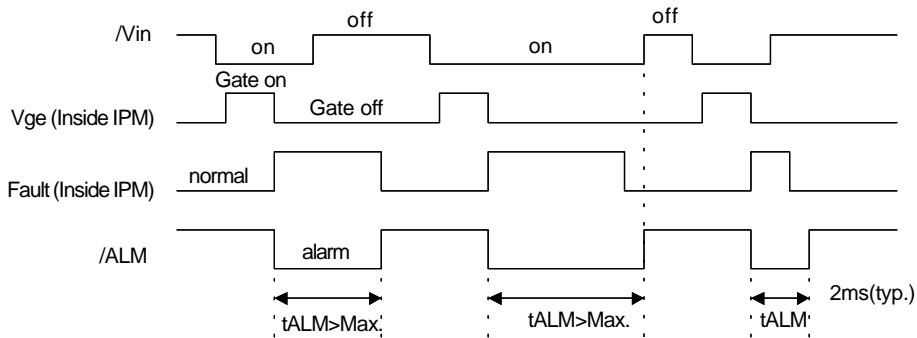

Figure 1. Switching Time Waveform Definitions



Fault : Over-current, Over-heat or Under-voltage

Figure 2. Input / Output Timing Diagram

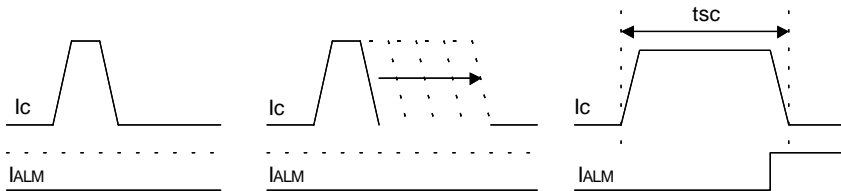

Figure 4 Definition of tsc

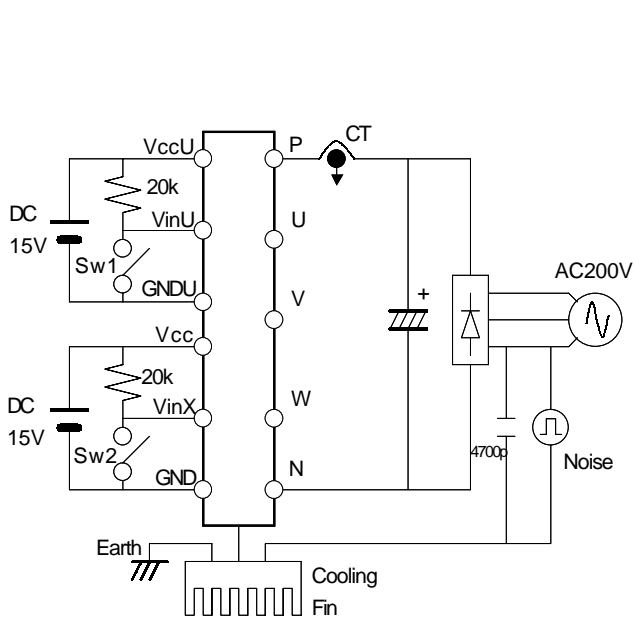

Figure 5. Noise Test Circuit

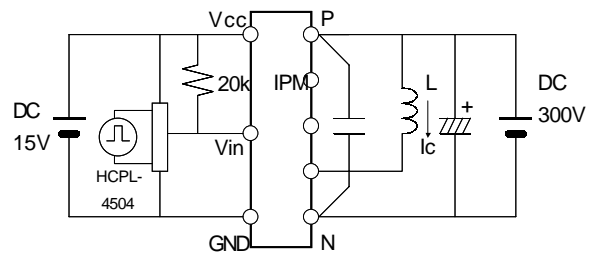

Figure 6. Switching Characteristics Test Circuit

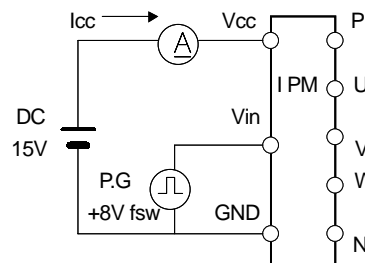
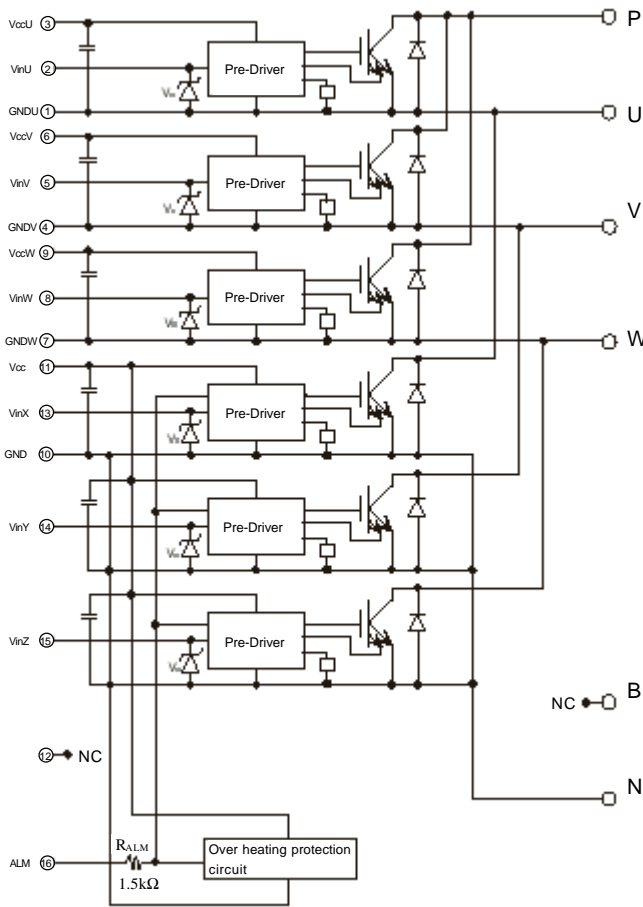

Figure 7. Icc Test Circuit

Block diagram



- Pre-driver include following functions
- ① Amplifier for drive
 - ② Short circuit protection
 - ③ Under voltage lockout circuit
 - ④ Over current protection
 - ⑤ IGBT chip over heating protection

Outline drawings, mm

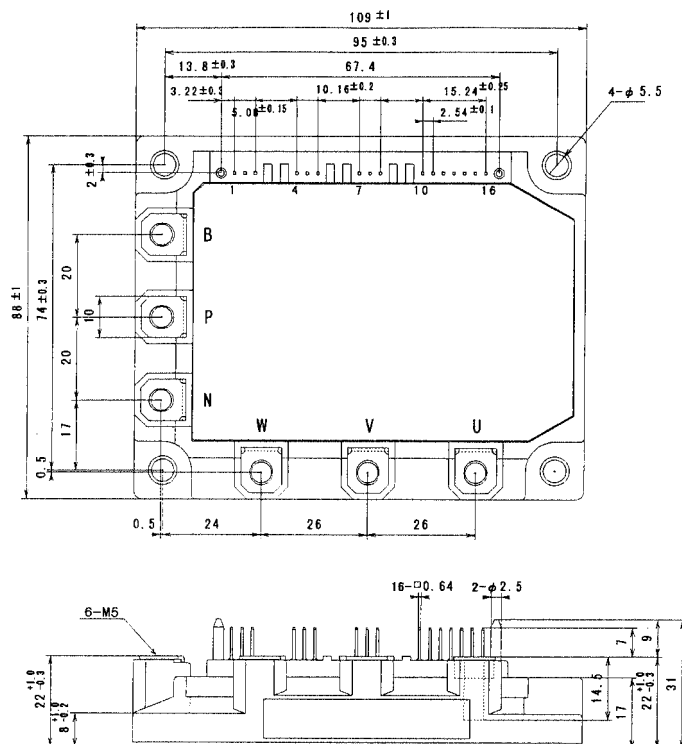

Mass : 450g

Characteristics

Control circuit characteristics (Representative)

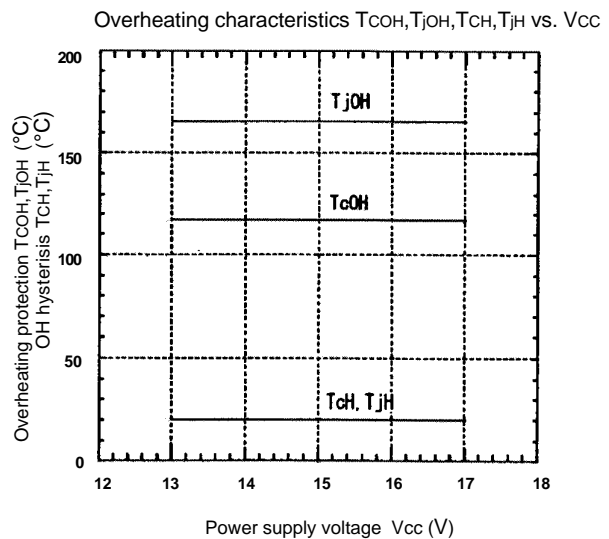
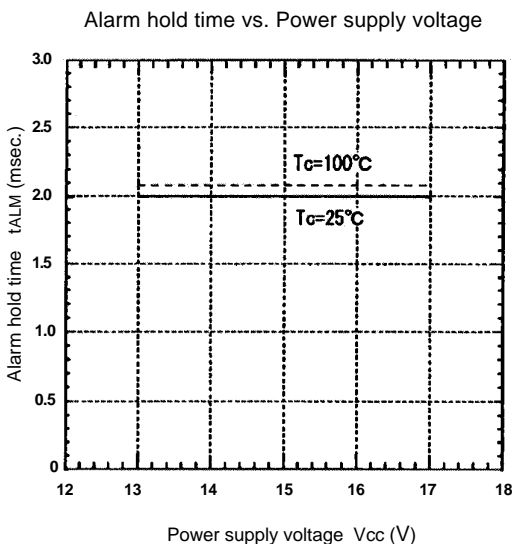
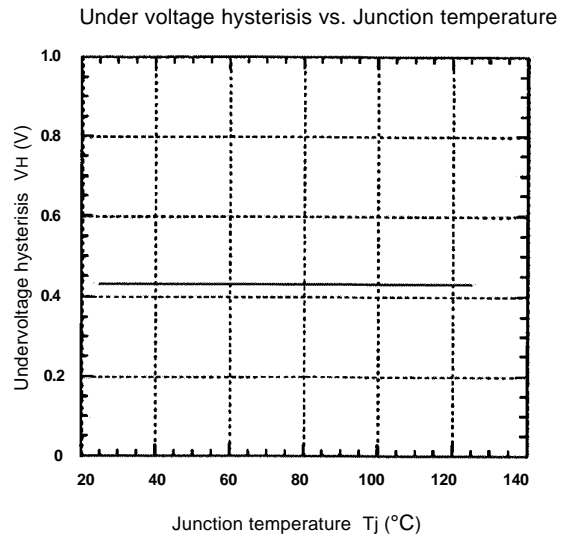
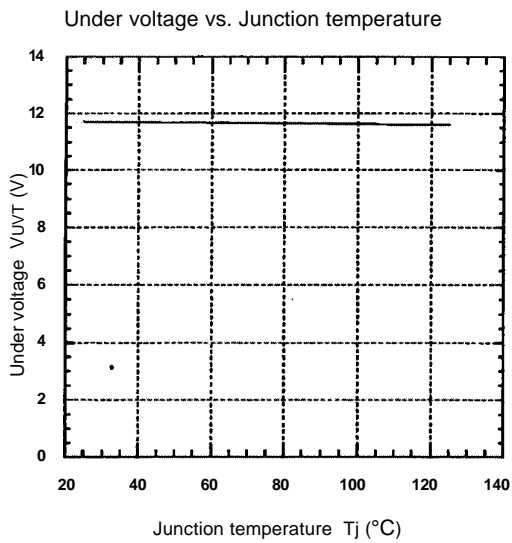
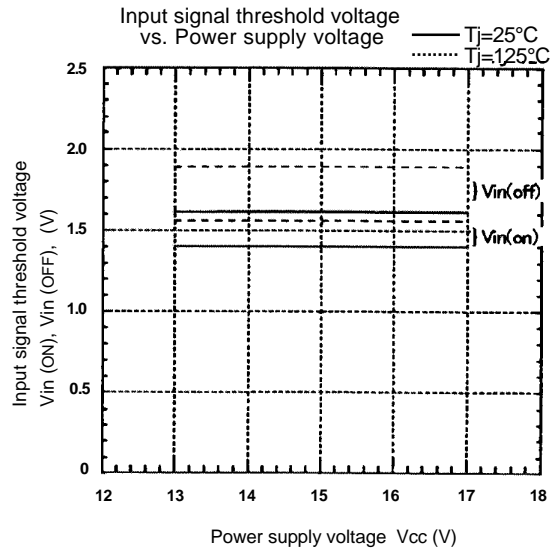
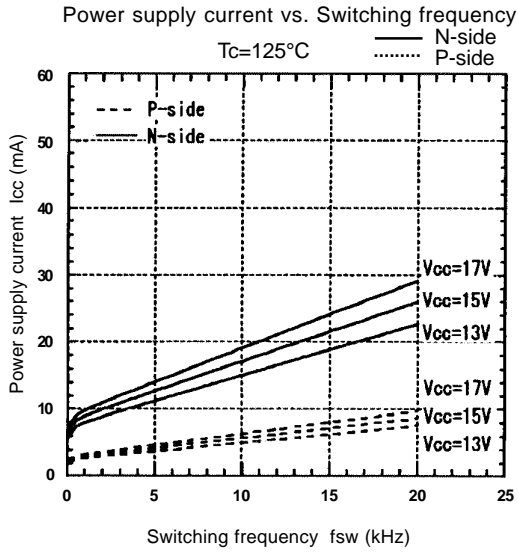

● Main circuit characteristics (Representative)

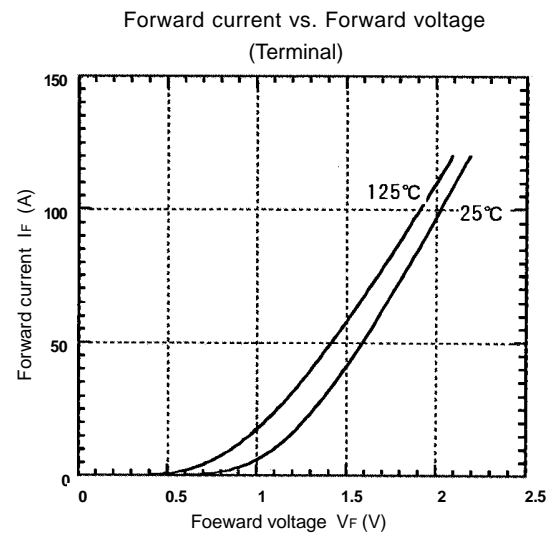
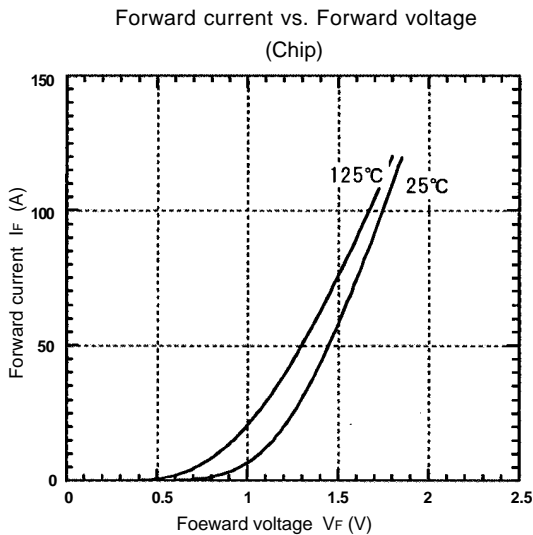
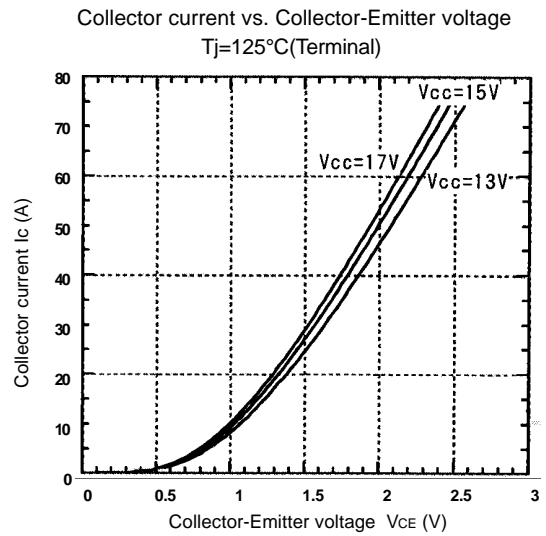
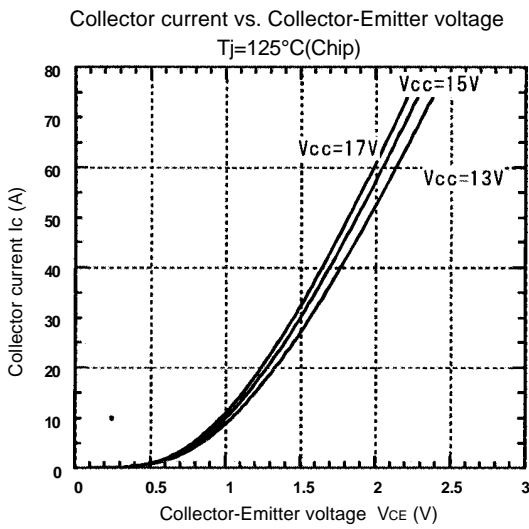
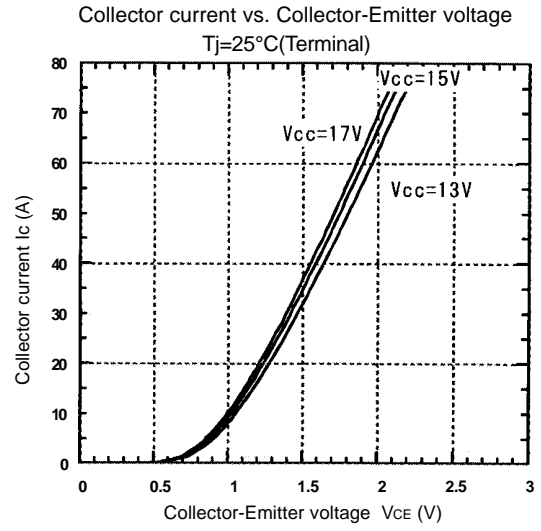
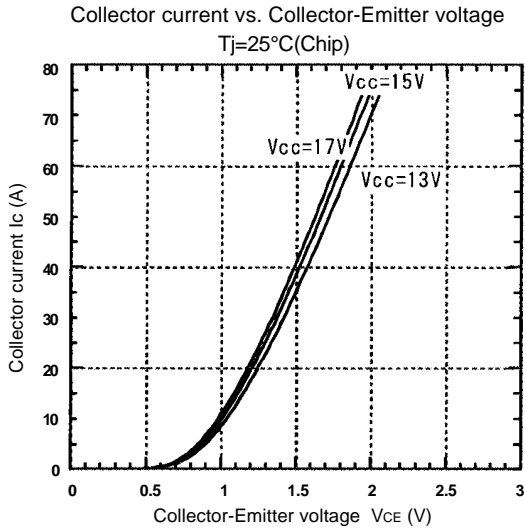

Switching Loss vs. Collector current
 $E_{dc}=300V, V_{cc}=15V, T_j=25^\circ C$

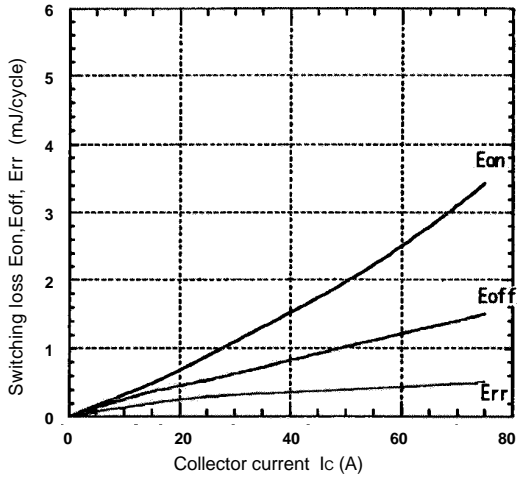

Switching Loss vs. Collector current
 $E_{dc}=300V, V_{cc}=15V, T_j=125^\circ C$

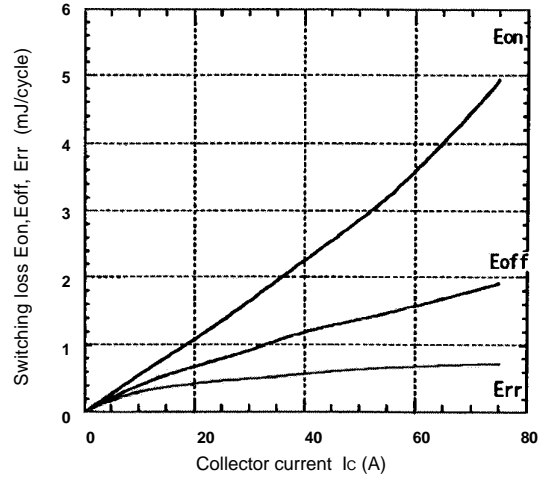

Reverse biased safe operating area
 $V_{cc}=15V, T_j \le 125^\circ C$

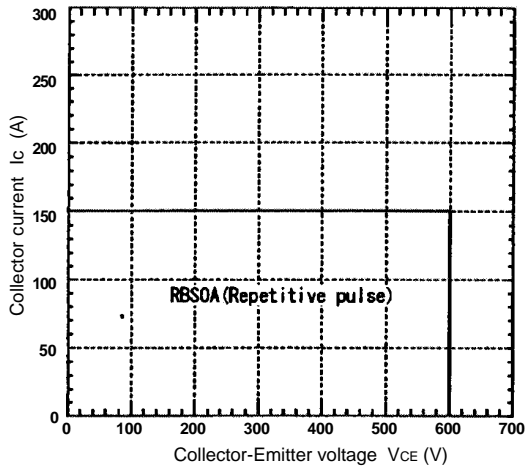

Transient thermal resistance

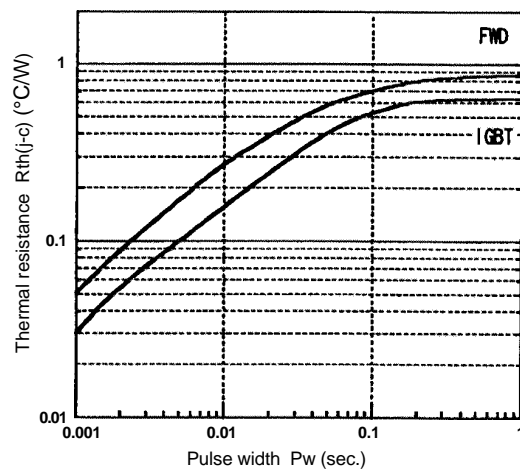

Power derating for IGBT (per device)

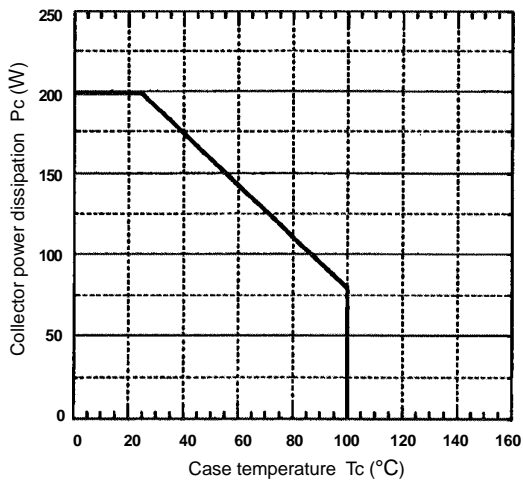

Power derating for FWD (per device)

