

M63813P/FP/GP/KP

7-UNIT 300mA TRANSISTOR ARRAY WITH CLAMP DIODE

PRELIMINARY
 Notice: This is not a final specification.
 Some parametric limits are subject to change.

DESCRIPTION

M63813P/FP/GP/KP are seven-circuit Single transistor arrays with clamping diodes. The circuits are made of NPN transistors. Both the semiconductor integrated circuits perform high-current driving with extremely low input-current supply.

FEATURES

- Four package configurations (P, FP, GP and KP)
- Medium breakdown voltage ($BV_{CEO} \geq 35V$)
- Synchronizing current ($I_{C(max)} = 300mA$)
- With clamping diodes
- Low output saturation voltage
- Wide operating temperature range ($T_a = -40$ to $+85^\circ C$)

APPLICATION

Driving of digit drives of indication elements (LEDs and lamps) with small signals

FUNCTION

The M63813P/FP/GP/KP each have seven circuits consisting of NPN transistor. A spike-killer clamping diode is provided between each output pin (collector) and COM pin (pin9). The transistor emitters are all connected to the GND pin (pin 8). The transistors allow synchronous flow of 300mA collector current. A maximum of 35V voltage can be applied between the collector and emitter.

PIN CONFIGURATION

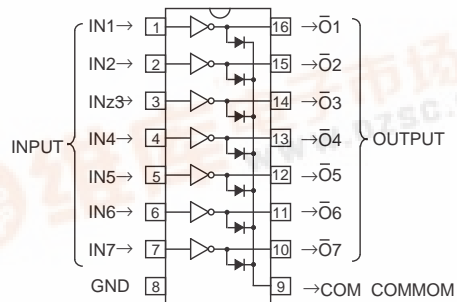

Package type
 16P4(P)
 16P2N-A(FP)
 16P2S-A(GP)
 16P2Z-A(KP)

CIRCUIT DIAGRAM

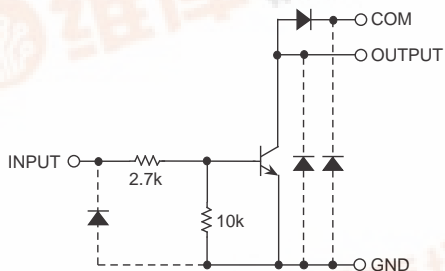

The seven circuits share the COM and GND.

The diode, indicated with the dotted line, is parasitic, and cannot be used.

Unit: Ω

ABSOLUTE MAXIMUM RATINGS (Unless otherwise noted, $T_a = -40 \sim +85^\circ C$)

Symbol	Parameter	Conditions	Ratings	Unit	
V_{CEO}	Collector-emitter voltage	Output, H	$-0.5 \sim +35$	V	
I_C	Collector current	Current per circuit output, L	300	mA	
V_i	Input voltage		$-0.5 \sim +35$	V	
I_F	Clamping diode forward current		300	mA	
V_R	Clamping diode reverse voltage		35	V	
P_d	Power dissipation	$T_a = 25^\circ C$, when mounted on board	M63813P	1.47	W
			M63813FP	1.00	
			M63813GP	0.80	
			M63813KP	0.78	
T_{opr}	Operating temperature		$-40 \sim +85$	$^\circ C$	
T_{stg}	Storage temperature		$-55 \sim +125$	$^\circ C$	



PRELIMINARY
 Notice: This is not a final specification.
 Some parametric limits are subject to change.

M63813P/FP/GP/KP

7-UNIT 300mA TRANSISTOR ARRAY WITH CLAMP DIODE

RECOMMENDED OPERATING CONDITIONS (Unless otherwise noted, Ta = -40 ~ +85°C)

Symbol	Parameter	Test conditions	Limits			Unit	
			min	typ	max		
V _O	Output voltage		0	—	35	V	
I _C	Collector current (Current per 1 circuit when 7 circuits are coming on simultaneously)	M63813P	Duty Cycle no more than 45%	0	—	250	mA
			Duty Cycle no more than 100%	0	—	160	
		M63813FP	Duty Cycle no more than 30%	0	—	250	
			Duty Cycle no more than 100%	0	—	130	
		M63813GP	Duty Cycle no more than 24%	0	—	250	
			Duty Cycle no more than 100%	0	—	120	
		M63813KP	Duty Cycle no more than 24%	0	—	250	
			Duty Cycle no more than 100%	0	—	120	
V _{IN}	Input voltage		0	—	20	V	

ELECTRICAL CHARACTERISTICS (Unless otherwise noted, Ta = 25°C)

Symbol	Parameter	Test conditions	Limits			Unit
			min	typ	max	
V (BR) CEO	Collector-emitter breakdown voltage	I _{CEO} = 10μA	35	—	—	V
V _{CE(sat)}	Collector-emitter saturation voltage	I _{IN} = 1mA, I _C = 10mA	—	—	0.2	V
		I _{IN} = 2mA, I _C = 150mA	—	—	0.8	
V _{IN(on)}	"On" input voltage	I _{IN} = 1mA, I _C = 10mA	2.4	35	4.2	V
V _F	Clamping diode forward voltage	I _F = 250mA	—	1.2	2.0	V
I _R	Clamping diode reverse current	V _R = 35V	—	—	10	μA
h _{FE}	DC amplification factor	V _{CE} = 10V, I _C = 10mA	50	—	—	—

SWITCHING CHARACTERISTICS (Unless otherwise noted, Ta = 25°C)

Symbol	Parameter	Test conditions	Limits			Unit
			min	typ	max	
t _{on}	Turn-on time	C _L = 15pF (note 1)	—	125	—	ns
t _{off}	Turn-off time		—	250	—	

NOTE 1 TEST CIRCUIT

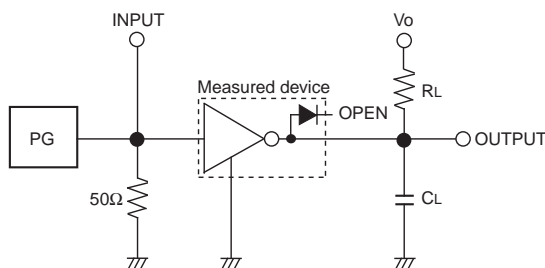

- (1) Pulse generator (PG) characteristics : PRR = 1kHz,
 t_w = 10μs, t_r = 6ns, t_f = 6ns, Z_o = 50Ω, V_{IH} = 3V
- (2) Input-output conditions : R_L = 220Ω, V_O = 35V
- (3) Electrostatic capacity C_L includes floating capacitance at connections and input capacitance at probes

TIMING DIAGRAM

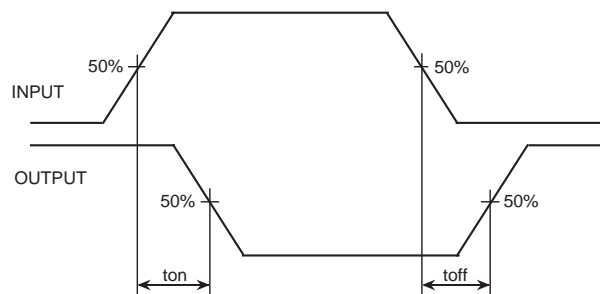

PRELIMINARY
 Notice: This is not a final specification.
 Some parametric limits are subject to change.

M63813P/FP/GP/KP

7-UNIT 300mA TRANSISTOR ARRAY WITH CLAMP DIODE

TYPICAL CHARACTERISTICS

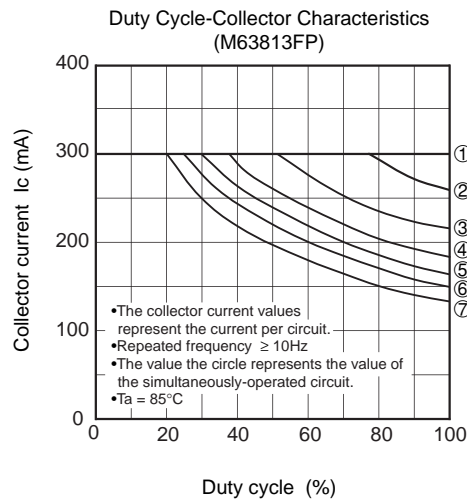
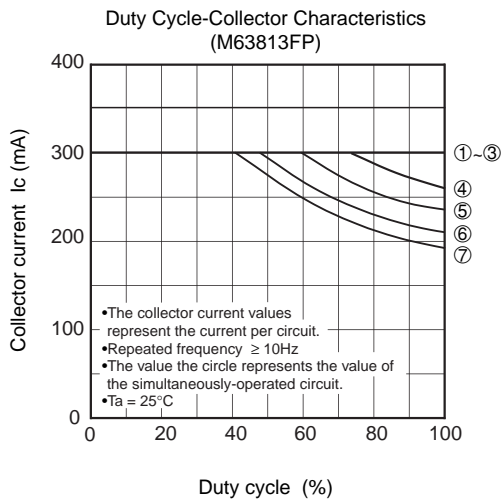
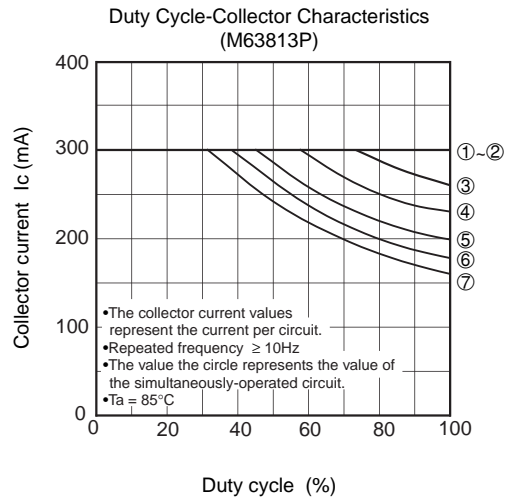
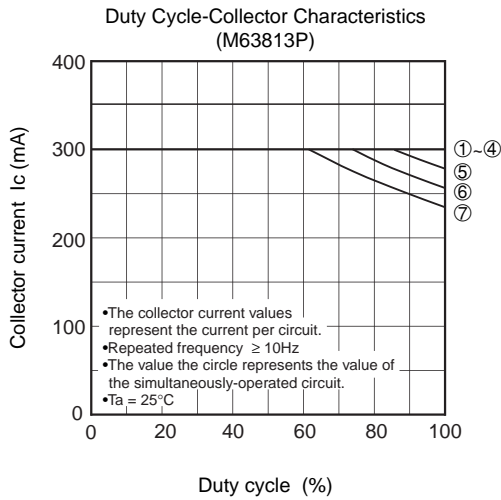
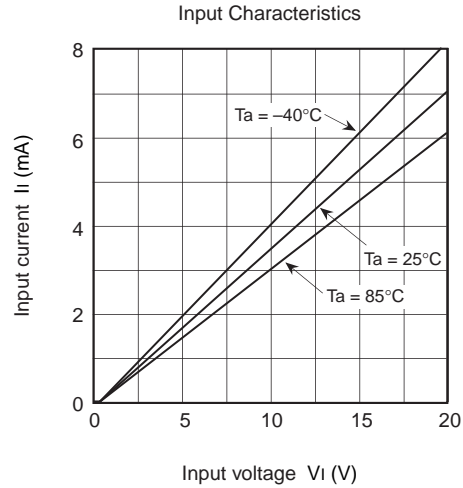
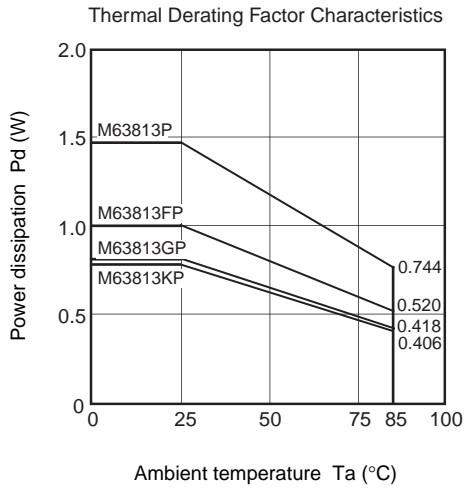

PRELIMINARY
 Notice: This is not a final specification.
 Some parametric limits are subject to change.

M63813P/FP/GP/KP

7-UNIT 300mA TRANSISTOR ARRAY WITH CLAMP DIODE

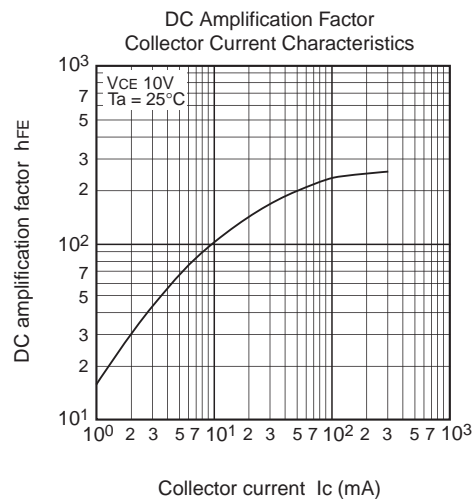
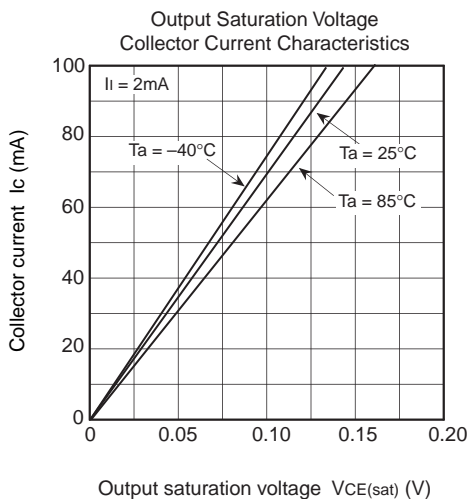
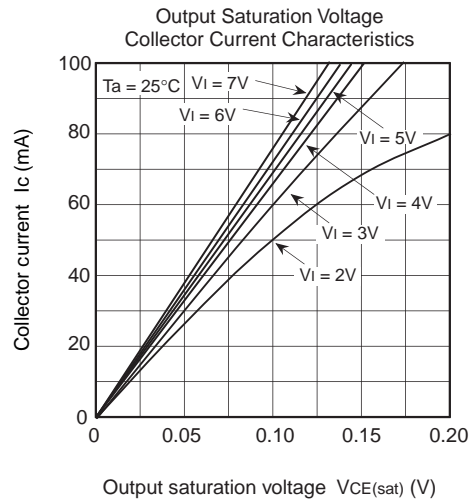
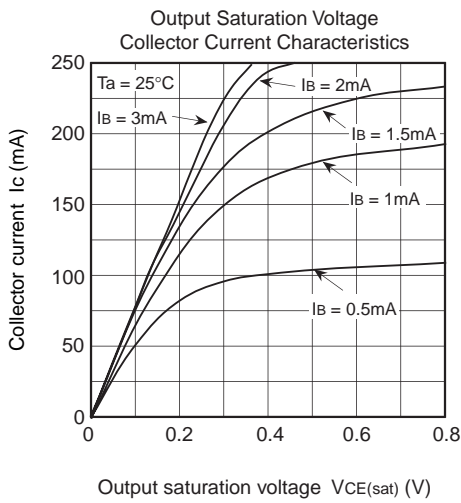
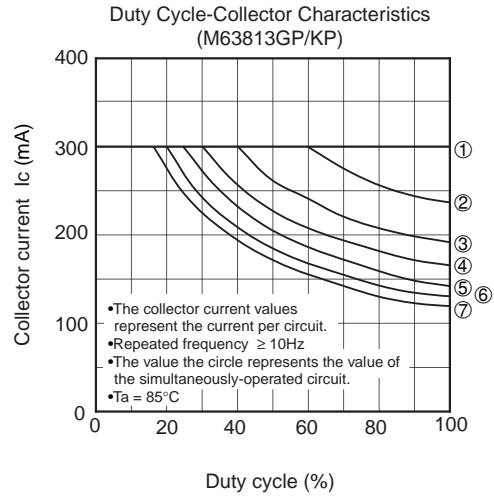
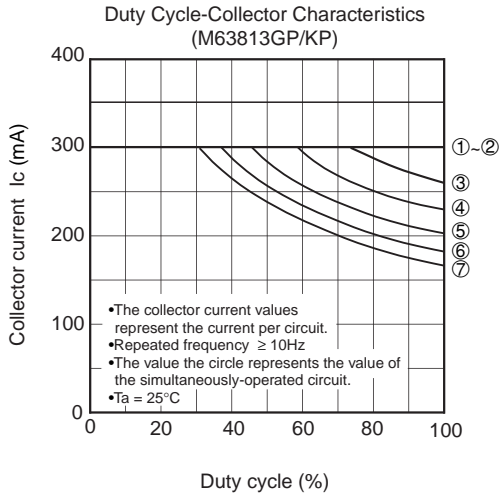

PRELIMINARY
 Notice: This is not a final specification.
 Some parametric limits are subject to change.

M63813P/FP/GP/KP

7-UNIT 300mA TRANSISTOR ARRAY WITH CLAMP DIODE

Grounded Emitter Transfer Characteristics

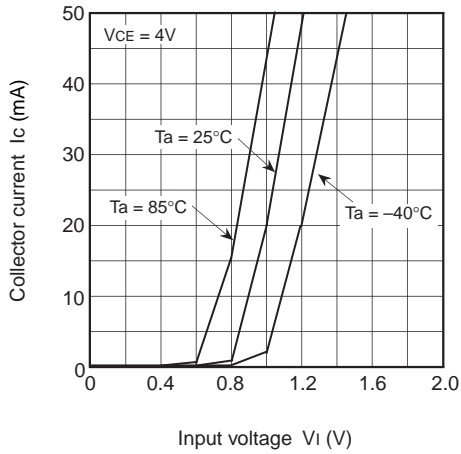

Grounded Emitter Transfer Characteristics

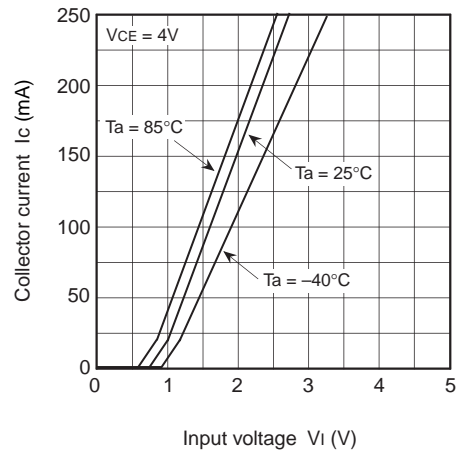

Clamping Diode Characteristics

