



# LTC2229

## 12-Bit, 80Mpsps Low Power 3V ADC

### FEATURES

- **Sample Rate: 80Mpsps**
- **Single 3V Supply (2.7V to 3.4V)**
- **Low Power: 211mW**
- **70.6dB SNR at 70MHz Input**
- **90dB SFDR at 70MHz Input**
- No Missing Codes
- Flexible Input: 1V<sub>P-P</sub> to 2V<sub>P-P</sub> Range
- 575MHz Full Power Bandwidth S/H
- Clock Duty Cycle Stabilizer
- Shutdown and Nap Modes
- Pin Compatible Family
  - 80Mpsps: LTC2229 (12-Bit), LTC2249 (14-Bit)
  - 65Mpsps: LTC2228 (12-Bit), LTC2248 (14-Bit)
  - 40Mpsps: LTC2227 (12-Bit), LTC2247 (14-Bit)
  - 25Mpsps: LTC2226 (12-Bit), LTC2246 (14-Bit)
  - 10Mpsps: LTC2225 (12-Bit), LTC2245 (14-Bit)
- 32-Pin (5mm × 5mm) QFN Package

### APPLICATIONS

- Wireless and Wired Broadband Communication
- Imaging Systems
- Ultrasound
- Spectral Analysis
- Portable Instrumentation

### DESCRIPTION

The LTC<sup>®</sup>2229 is a 12-bit 80Mpsps, low power 3V A/D converter designed for digitizing high frequency, wide dynamic range signals. The LTC2229 is perfect for demanding imaging and communications applications with AC performance that includes 70.6dB SNR and 90dB SFDR for signals well beyond the Nyquist frequency.

DC specs include ±0.4LSB INL (typ), ±0.2LSB DNL (typ) and no missing codes over temperature. The transition noise is a low 0.3LSB<sub>RMS</sub>.

A single 3V supply allows low power operation. A separate output supply allows the outputs to drive 0.5V to 3.3V logic.

A single-ended CLK input controls converter operation. An optional clock duty cycle stabilizer allows high performance at full speed for a wide range of clock duty cycles.

LT, LTC and LT are registered trademarks of Linear Technology Corporation.

### TYPICAL APPLICATION

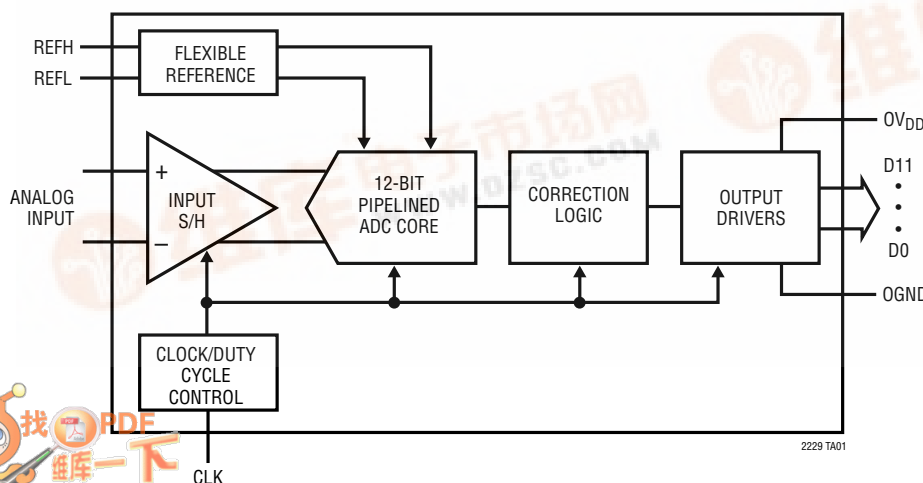

SNR vs Input Frequency,  
-1dB, 2V Range

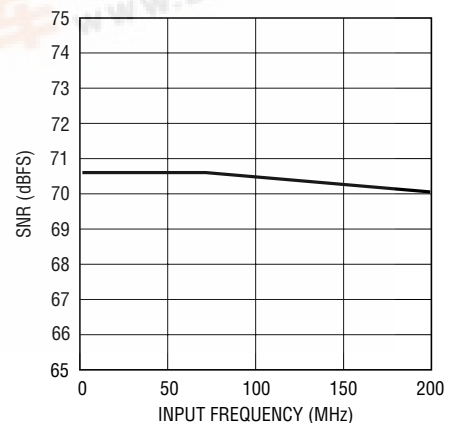

2229 G09

2229f



# LTC2229

## ABSOLUTE MAXIMUM RATINGS

$OV_{DD} = V_{DD}$  (Notes 1, 2)

Supply Voltage ( $V_{DD}$ )	4V
Digital Output Ground Voltage (OGND)	-0.3V to 1V
Analog Input Voltage (Note 3)	-0.3V to ( $V_{DD} + 0.3V$ )
Digital Input Voltage	-0.3V to ( $V_{DD} + 0.3V$ )
Digital Output Voltage	-0.3V to ( $OV_{DD} + 0.3V$ )
Power Dissipation	1500mW
Operating Temperature Range	
LTC2229C	0°C to 70°C
LTC2229I	-40°C to 85°C
Storage Temperature Range	-65°C to 125°C
Lead Temperature (Soldering, 10 sec)	300°C

## PACKAGE/ORDER INFORMATION

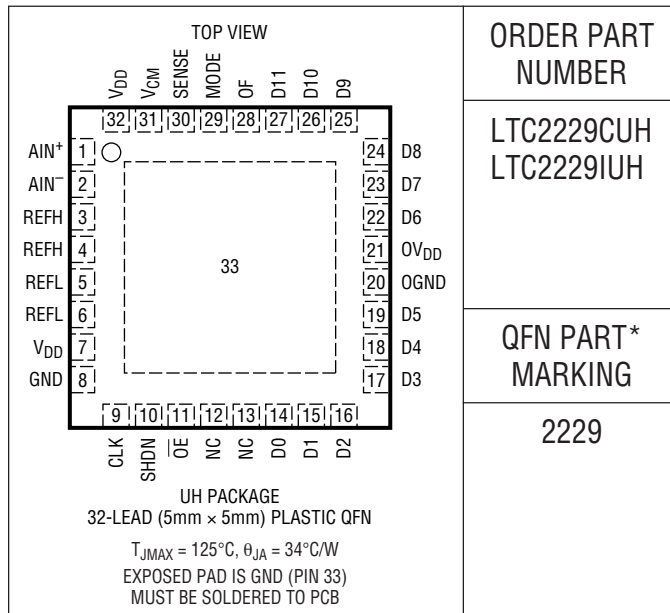

ORDER PART NUMBER
LTC2229CUH LTC2229IUH
QFN PART* MARKING
2229

Consult LTC Marketing for parts specified with wider operating temperature ranges.  
\*The temperature grade is identified by a label on the shipping container.

## CONVERTER CHARACTERISTICS

The ● denotes the specifications which apply over the full operating temperature range, otherwise specifications are at  $T_A = 25^\circ\text{C}$ . (Note 4)

PARAMETER	CONDITIONS	MIN	TYP	MAX	UNITS
Resolution (No Missing Codes)		●	12		Bits
Integral Linearity Error	Differential Analog Input (Note 5)	●	-1.1	±0.4 1.1	LSB
Differential Linearity Error	Differential Analog Input	●	-0.8	±0.2 0.8	LSB
Offset Error	(Note 6)	●	-12	±2 12	mV
Gain Error	External Reference	●	-2.5	±0.5 2.5	%FS
Offset Drift			±10		μV/°C
Full-Scale Drift	Internal Reference		±30		ppm/°C
	External Reference		±15		ppm/°C
Transition Noise	SENSE = 1V		0.3		LSBRMS

## ANALOG INPUT

The ● denotes the specifications which apply over the full operating temperature range, otherwise specifications are at  $T_A = 25^\circ\text{C}$ . (Note 4)

SYMBOL	PARAMETER	CONDITIONS	MIN	TYP	MAX	UNITS
$V_{IN}$	Analog Input Range ( $A_{IN+} - A_{IN-}$ )	$2.7V < V_{DD} < 3.4V$ (Note 7)	●	1V to 2V		V
$V_{IN,CM}$	Analog Input Common Mode	Differential Input (Note 7)	●	1 1.5 1.9		V
$I_{IN}$	Analog Input Leakage Current	$0V < A_{IN+}, A_{IN-} < V_{DD}$	●	-1	1	μA
$I_{SENSE}$	SENSE Input Leakage	$0V < SENSE < 1V$	●	-3	3	μA
$I_{MODE}$	MODE Pin Leakage		●	-3	3	μA
$t_{AP}$	Sample-and-Hold Acquisition Delay Time			0		ns
$t_{JITTER}$	Sample-and-Hold Acquisition Delay Time Jitter			0.2		psRMS
CMRR	Analog Input Common Mode Rejection Ratio			80		dB

## DYNAMIC ACCURACY

The ● denotes the specifications which apply over the full operating temperature range, otherwise specifications are at  $T_A = 25^\circ\text{C}$ .  $A_{IN} = -1\text{dBFS}$ . (Note 4)

SYMBOL	PARAMETER	CONDITIONS	MIN	TYP	MAX	UNITS
SNR	Signal-to-Noise Ratio	5MHz Input		70.6		dB
		40MHz Input	●	68.9	70.6	dB
		70MHz Input		70.6		dB
		140MHz Input		70.3		dB
SFDR	Spurious Free Dynamic Range 2nd or 3rd Harmonic	5MHz Input		90		dB
		40MHz Input	●	74	90	dB
		70MHz Input		90		dB
		140MHz Input		85		dB
SFDR	Spurious Free Dynamic Range 4th Harmonic or Higher	5MHz Input		95		dB
		40MHz Input	●	80	95	dB
		70MHz Input		95		dB
		140MHz Input		90		dB
S/(N+D)	Signal-to-Noise Plus Distortion Ratio	5MHz Input		70.6		dB
		40MHz Input	●	68.5	70.5	dB
		70MHz Input		70.5		dB
		140MHz Input		70		dB
$I_{MD}$	Intermodulation Distortion	$f_{IN1} = 28.2\text{MHz}$ , $f_{IN2} = 26.8\text{MHz}$		90		dB
	Full Power Bandwidth	Figure 8 Test Circuit		575		MHz

## INTERNAL REFERENCE CHARACTERISTICS (Note 4)

PARAMETER	CONDITIONS	MIN	TYP	MAX	UNITS
$V_{CM}$ Output Voltage	$I_{OUT} = 0$	1.475	1.500	1.525	V
$V_{CM}$ Output Tempco			±30		ppm/°C
$V_{CM}$ Line Regulation	$2.7\text{V} < V_{DD} < 3.4\text{V}$		3		mV/V
$V_{CM}$ Output Resistance	$-1\text{mA} < I_{OUT} < 1\text{mA}$		4		Ω

## DIGITAL INPUTS AND DIGITAL OUTPUTS

The ● denotes the specifications which apply over the full operating temperature range, otherwise specifications are at  $T_A = 25^\circ\text{C}$ . (Note 4)

SYMBOL	PARAMETER	CONDITIONS	MIN	TYP	MAX	UNITS
<b>LOGIC INPUTS (CLK, <math>\overline{\text{OE}}</math>, SHDN)</b>						
$V_{IH}$	High Level Input Voltage	$V_{DD} = 3\text{V}$	●	2		V
$V_{IL}$	Low Level Input Voltage	$V_{DD} = 3\text{V}$	●		0.8	V
$I_{IN}$	Input Current	$V_{IN} = 0\text{V}$ to $V_{DD}$	●	-10	10	$\mu\text{A}$
$C_{IN}$	Input Capacitance	(Note 7)		3		pF
<b>LOGIC OUTPUTS</b>						
<b><math>OV_{DD} = 3\text{V}</math></b>						
$C_{OZ}$	Hi-Z Output Capacitance	$\overline{\text{OE}} = \text{High}$ (Note 7)		3		pF
$I_{SOURCE}$	Output Source Current	$V_{OUT} = 0\text{V}$		50		mA
$I_{SINK}$	Output Sink Current	$V_{OUT} = 3\text{V}$		50		mA
$V_{OH}$	High Level Output Voltage	$I_O = -10\mu\text{A}$ $I_O = -200\mu\text{A}$	●	2.7	2.995 2.99	V V
$V_{OL}$	Low Level Output Voltage	$I_O = 10\mu\text{A}$ $I_O = 1.6\text{mA}$	●		0.005 0.09	V V
<b><math>OV_{DD} = 2.5\text{V}</math></b>						
$V_{OH}$	High Level Output Voltage	$I_O = -200\mu\text{A}$		2.49		V
$V_{OL}$	Low Level Output Voltage	$I_O = 1.6\text{mA}$		0.09		V
<b><math>OV_{DD} = 1.8\text{V}</math></b>						
$V_{OH}$	High Level Output Voltage	$I_O = -200\mu\text{A}$		1.79		V
$V_{OL}$	Low Level Output Voltage	$I_O = 1.6\text{mA}$		0.09		V

## POWER REQUIREMENTS

The ● denotes the specifications which apply over the full operating temperature range, otherwise specifications are at  $T_A = 25^\circ\text{C}$ . (Note 8)

SYMBOL	PARAMETER	CONDITIONS	MIN	TYP	MAX	UNITS	
$V_{DD}$	Analog Supply Voltage	(Note 9)	●	2.7	3	3.4	V
$OV_{DD}$	Output Supply Voltage	(Note 9)	●	0.5	3	3.6	V
$I_{VDD}$	Supply Current		●	70.3	82	mA	
$P_{DISS}$	Power Dissipation		●	211	246	mW	
$P_{SHDN}$	Shutdown Power	SHDN = H, $\overline{\text{OE}} = \text{H}$ , No CLK		2		mW	
$P_{NAP}$	Nap Mode Power	SHDN = H, $\overline{\text{OE}} = \text{L}$ , No CLK		15		mW	

## TIMING CHARACTERISTICS

The ● denotes the specifications which apply over the full operating temperature range, otherwise specifications are at  $T_A = 25^\circ\text{C}$ . (Note 4)

SYMBOL	PARAMETER	CONDITIONS	MIN	TYP	MAX	UNITS	
$f_s$	Sampling Frequency	(Note 9)	●	1	80	MHz	
$t_L$	CLK Low Time	Duty Cycle Stabilizer Off Duty Cycle Stabilizer On (Note 7)	●	5.9	6.25	500	ns
$t_H$	CLK High Time	Duty Cycle Stabilizer Off Duty Cycle Stabilizer On (Note 7)	●	5.9	6.25	500	ns
$t_{AP}$	Sample-and-Hold Aperture Delay			0		ns	
$t_D$	CLK to DATA Delay	$C_L = 5\text{pF}$ (Note 7)	●	1.4	2.7	5.4	ns
	Data Access Time After $\overline{\text{OE}} \downarrow$	$C_L = 5\text{pF}$ (Note 7)	●	4.3	10	ns	
	BUS Relinquish Time	(Note 7)	●	3.3	8.5	ns	
Pipeline Latency				6		Cycles	

**Note 1:** Absolute Maximum Ratings are those values beyond which the life of a device may be impaired.

**Note 2:** All voltage values are with respect to ground with GND and OGND wired together (unless otherwise noted).

**Note 3:** When these pin voltages are taken below GND or above  $V_{DD}$ , they will be clamped by internal diodes. This product can handle input currents of greater than 100mA below GND or above  $V_{DD}$  without latching.

**Note 4:**  $V_{DD} = 3\text{V}$ ,  $f_{\text{SAMPLE}} = 80\text{MHz}$ , input range =  $2V_{P-P}$  with differential drive, unless otherwise noted.

**Note 5:** Integral nonlinearity is defined as the deviation of a code from a straight line passing through the actual endpoints of the transfer curve. The deviation is measured from the center of the quantization band.

**Note 6:** Offset error is the offset voltage measured from  $-0.5\text{LSB}$  when the output code flickers between 0000 0000 0000 and 1111 1111 1111.

**Note 7:** Guaranteed by design, not subject to test.

**Note 8:**  $V_{DD} = 3\text{V}$ ,  $f_{\text{SAMPLE}} = 80\text{MHz}$ , input range =  $1V_{P-P}$  with differential drive.

**Note 9:** Recommended operating conditions.

## TYPICAL PERFORMANCE CHARACTERISTICS

Typical INL, 2V Range

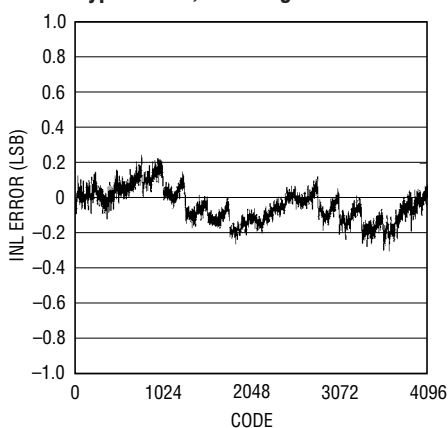

Typical DNL, 2V Range

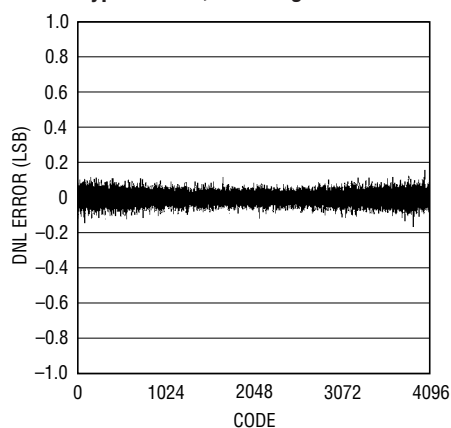

8192 Point FFT,  $f_{IN} = 5\text{MHz}$ ,  $-1\text{dB}$ , 2V Range

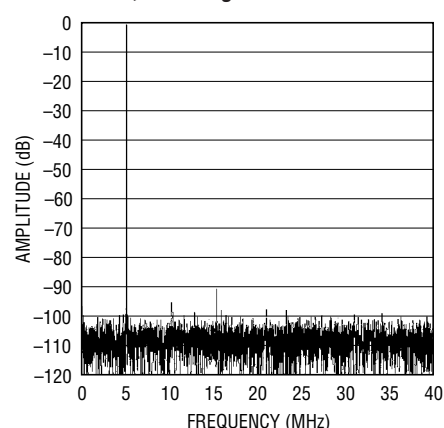

# TYPICAL PERFORMANCE CHARACTERISTICS

8192 Point FFT,  $f_{IN} = 30\text{MHz}$ ,  
-1dB, 2V Range

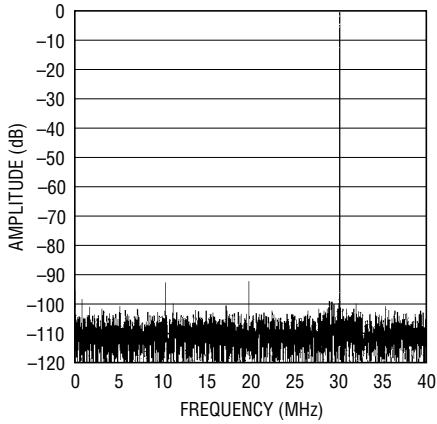

2229 G04

8192 Point FFT,  $f_{IN} = 70\text{MHz}$ ,  
-1dB, 2V Range

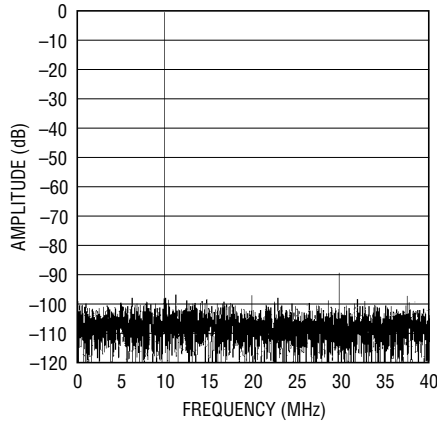

2229 G05

8192 Point FFT,  $f_{IN} = 140\text{MHz}$ ,  
-1dB, 2V Range

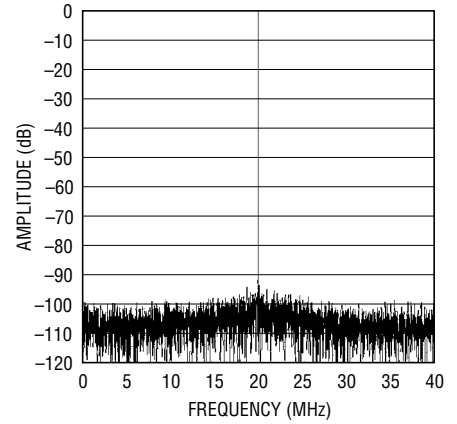

2229 G06

8192 Point 2-Tone FFT,  
 $f_{IN} = 28.2\text{MHz}$  and  $26.8\text{MHz}$ ,  
-1dB, 2V Range

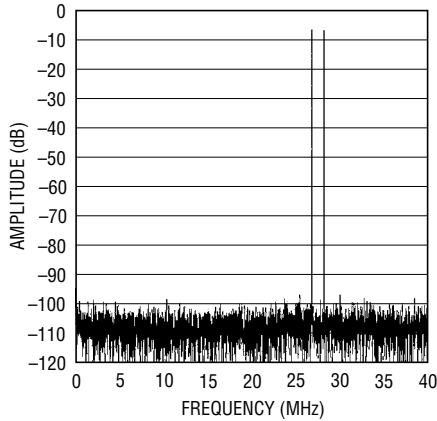

2229 G07

Grounded Input Histogram

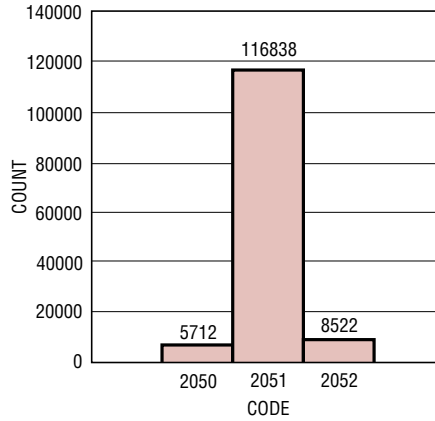

2229 G08

SNR vs Input Frequency,  
-1dB, 2V Range

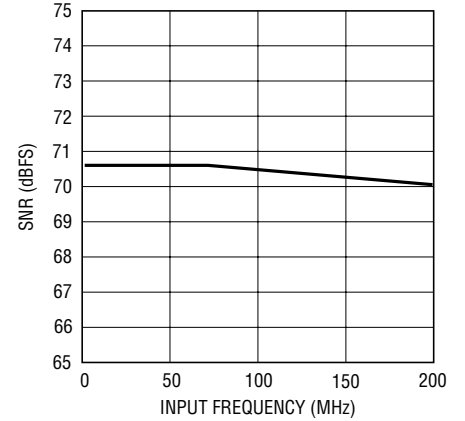

2229 G09

SFDR vs Input Frequency,  
-1dB, 2V Range

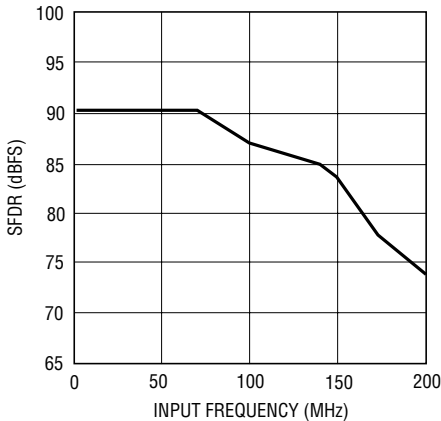

2229 G10

SNR and SFDR vs Sample Rate,  
2V Range,  $f_{IN} = 5\text{MHz}$ , -1dB

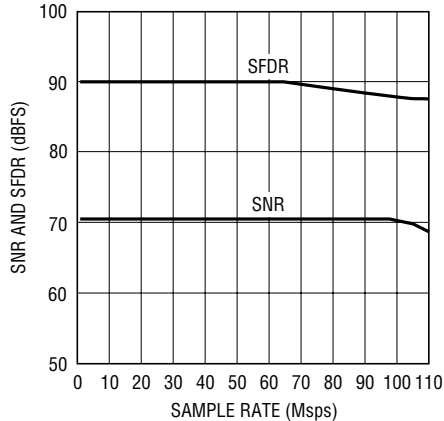

2229 G11

SNR and SFDR vs Clock Duty Cycle

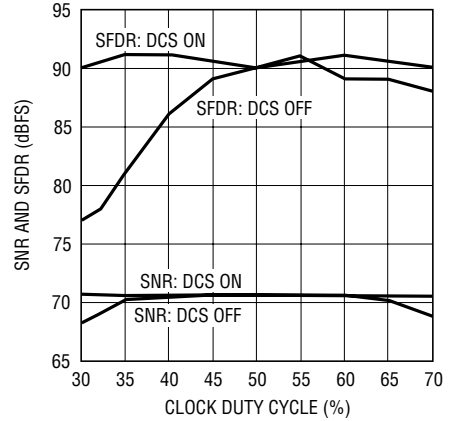

2229 G12

## TYPICAL PERFORMANCE CHARACTERISTICS

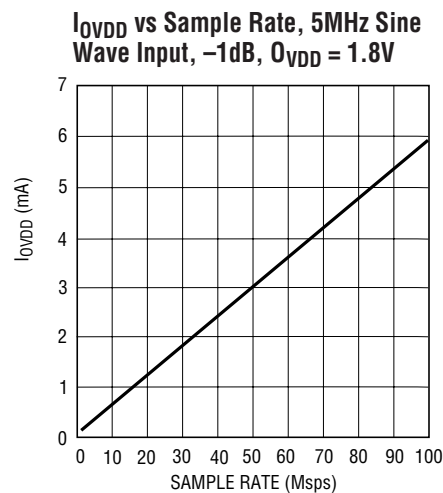
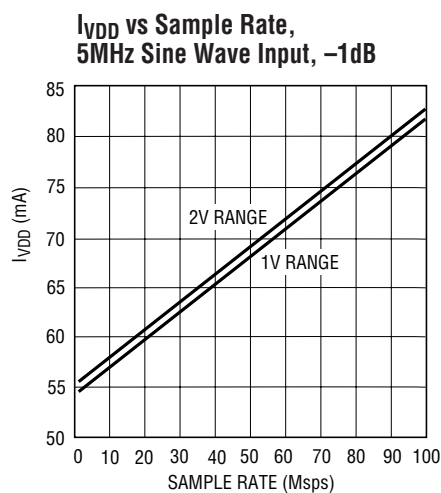
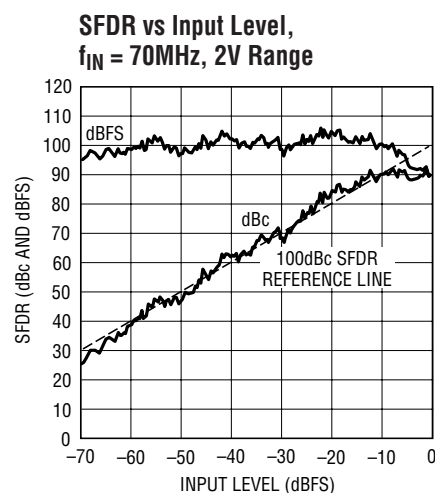
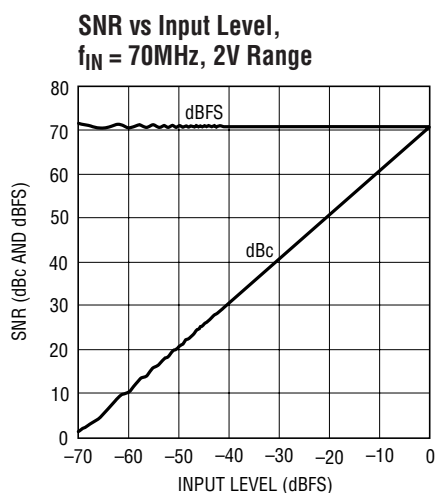

## PIN FUNCTIONS

**$A_{IN+}$  (Pin 1):** Positive Differential Analog Input.

**$A_{IN-}$  (Pin 2):** Negative Differential Analog Input.

**REFH (Pins 3, 4):** ADC High Reference. Short together and bypass to pins 5, 6 with a  $0.1\mu\text{F}$  ceramic chip capacitor as close to the pin as possible. Also bypass to pins 5, 6 with an additional  $2.2\mu\text{F}$  ceramic chip capacitor and to ground with a  $1\mu\text{F}$  ceramic chip capacitor.

**REFL (Pins 5, 6):** ADC Low Reference. Short together and bypass to pins 3, 4 with a  $0.1\mu\text{F}$  ceramic chip capacitor as close to the pin as possible. Also bypass to pins 3, 4 with an additional  $2.2\mu\text{F}$  ceramic chip capacitor and to ground with a  $1\mu\text{F}$  ceramic chip capacitor.

**$V_{DD}$  (Pins 7, 32):** 3V Supply. Bypass to GND with  $0.1\mu\text{F}$  ceramic chip capacitors.

**GND (Pin 8):** ADC Power Ground.

**CLK (Pin 9):** Clock Input. The input sample starts on the positive edge.

**SHDN (Pin 10):** Shutdown Mode Selection Pin. Connecting SHDN to GND and OE to GND results in normal operation with the outputs enabled. Connecting SHDN to GND and OE to  $V_{DD}$  results in normal operation with the outputs at high impedance. Connecting SHDN to  $V_{DD}$  and OE to GND results in nap mode with the outputs at high

## PIN FUNCTIONS

impedance. Connecting SHDN to  $V_{DD}$  and  $\overline{OE}$  to  $V_{DD}$  results in sleep mode with the outputs at high impedance.

**$\overline{OE}$  (Pin 11):** Output Enable Pin. Refer to SHDN pin function.

**NC (Pins 12, 13):** Do Not Connect These Pins.

**D0–D11 (Pins 14, 15, 16, 17, 18, 19, 22, 23, 24, 25, 26, 27):** Digital Outputs. D11 is the MSB.

**OGND (Pin 20):** Output Driver Ground.

**$OV_{DD}$  (Pin 21):** Positive Supply for the Output Drivers. Bypass to ground with 0.1 $\mu$ F ceramic chip capacitor.

**OF (Pin 28):** Over/Under Flow Output. High when an over or under flow has occurred.

**MODE (Pin 29):** Output Format and Clock Duty Cycle Stabilizer Selection Pin. Connecting MODE to GND selects straight binary output format and turns the clock duty

cycle stabilizer off.  $1/3 V_{DD}$  selects straight binary output format and turns the clock duty cycle stabilizer on.  $2/3 V_{DD}$  selects 2's complement output format and turns the clock duty cycle stabilizer on.  $V_{DD}$  selects 2's complement output format and turns the clock duty cycle stabilizer off.

**SENSE (Pin 30):** Reference Programming Pin. Connecting SENSE to  $V_{CM}$  selects the internal reference and a  $\pm 0.5V$  input range.  $V_{DD}$  selects the internal reference and a  $\pm 1V$  input range. An external reference greater than 0.5V and less than 1V applied to SENSE selects an input range of  $\pm V_{SENSE}$ .  $\pm 1V$  is the largest valid input range.

**$V_{CM}$  (Pin 31):** 1.5V Output and Input Common Mode Bias. Bypass to ground with 2.2 $\mu$ F ceramic chip capacitor.

**GND (Exposed Pad) (Pin 33):** ADC Power Ground. The exposed pad on the bottom of the package needs to be soldered to ground.

## FUNCTIONAL BLOCK DIAGRAM

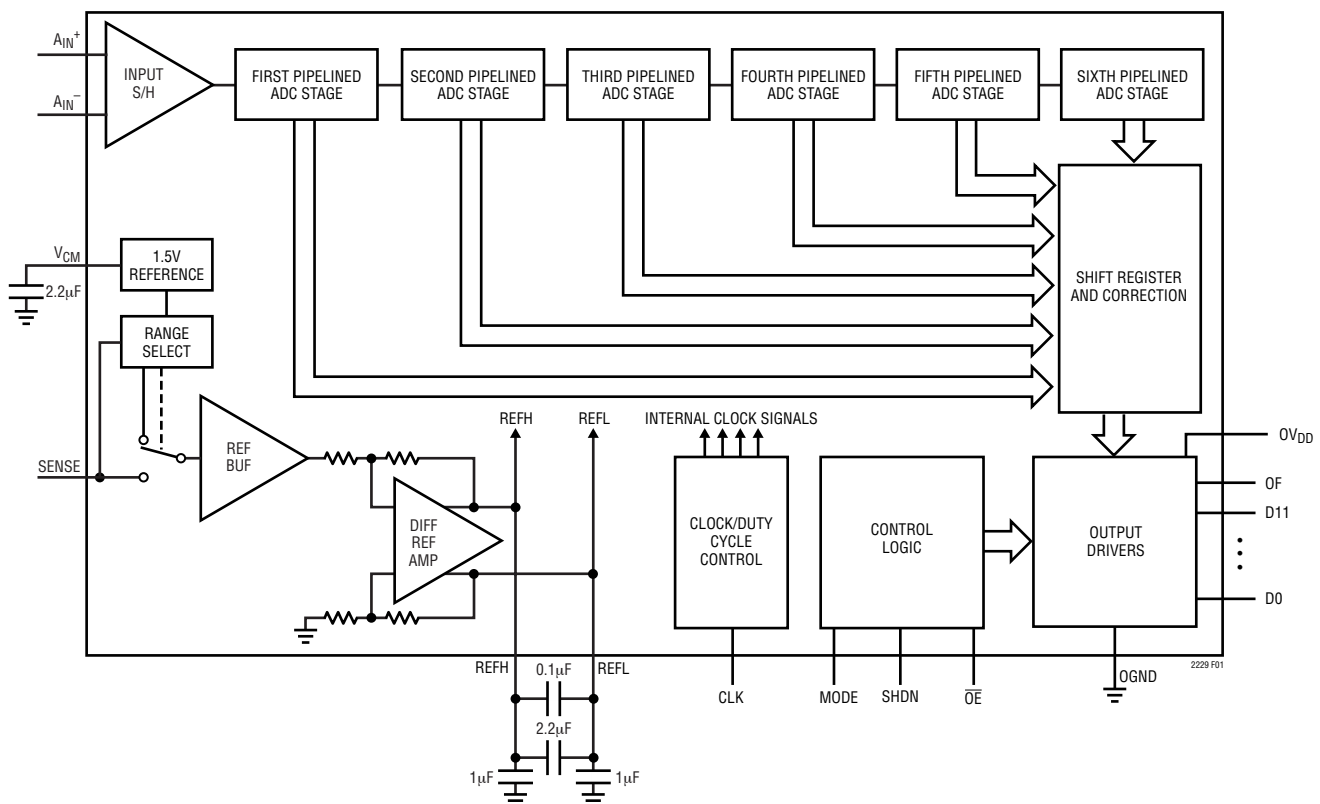
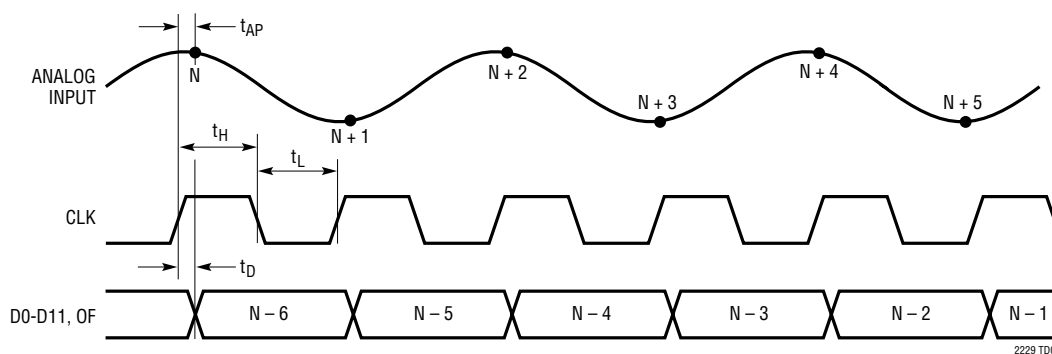

Figure 1. Functional Block Diagram

## TIMING DIAGRAM



## APPLICATIONS INFORMATION

### DYNAMIC PERFORMANCE

#### Signal-to-Noise Plus Distortion Ratio

The signal-to-noise plus distortion ratio  $[S/(N + D)]$  is the ratio between the RMS amplitude of the fundamental input frequency and the RMS amplitude of all other frequency components at the ADC output. The output is band limited to frequencies above DC to below half the sampling frequency.

#### Signal-to-Noise Ratio

The signal-to-noise ratio (SNR) is the ratio between the RMS amplitude of the fundamental input frequency and the RMS amplitude of all other frequency components except the first five harmonics and DC.

#### Total Harmonic Distortion

Total harmonic distortion is the ratio of the RMS sum of all harmonics of the input signal to the fundamental itself. The out-of-band harmonics alias into the frequency band between DC and half the sampling frequency. THD is expressed as:

$$\text{THD} = 20\text{Log} \sqrt{(V_2^2 + V_3^2 + V_4^2 + \dots + V_n^2)} / V_1$$

where  $V_1$  is the RMS amplitude of the fundamental frequency and  $V_2$  through  $V_n$  are the amplitudes of the second through  $n$ th harmonics. The THD calculated in this data sheet uses all the harmonics up to the fifth.

#### Intermodulation Distortion

If the ADC input signal consists of more than one spectral component, the ADC transfer function nonlinearity can produce intermodulation distortion (IMD) in addition to THD. IMD is the change in one sinusoidal input caused by the presence of another sinusoidal input at a different frequency.

If two pure sine waves of frequencies  $f_a$  and  $f_b$  are applied to the ADC input, nonlinearities in the ADC transfer function can create distortion products at the sum and difference frequencies of  $m f_a \pm n f_b$ , where  $m$  and  $n = 0, 1, 2, 3$ , etc. The 3rd order intermodulation products are  $2f_a + f_b$ ,  $2f_b + f_a$ ,  $2f_a - f_b$  and  $2f_b - f_a$ . The intermodulation distortion is defined as the ratio of the RMS value of either input tone to the RMS value of the largest 3rd order intermodulation product.

#### Spurious Free Dynamic Range (SFDR)

Spurious free dynamic range is the peak harmonic or spurious noise that is the largest spectral component excluding the input signal and DC. This value is expressed in decibels relative to the RMS value of a full scale input signal.

#### Input Bandwidth

The input bandwidth is that input frequency at which the amplitude of the reconstructed fundamental is reduced by 3dB for a full scale input signal.



## APPLICATIONS INFORMATION

high to low, the inputs are reconnected to the sampling capacitors to acquire a new sample. Since the sampling capacitors still hold the previous sample, a charging glitch proportional to the change in voltage between samples will be seen at this time. If the change between the last sample and the new sample is small, the charging glitch seen at the input will be small. If the input change is large, such as the change seen with input frequencies near Nyquist, then a larger charging glitch will be seen.

### Single-Ended Input

For cost sensitive applications, the analog inputs can be driven single-ended. With a single-ended input the harmonic distortion and INL will degrade, but the SNR and DNL will remain unchanged. For a single-ended input,  $A_{IN}^+$  should be driven with the input signal and  $A_{IN}^-$  should be connected to 1.5V or  $V_{CM}$ .

### Common Mode Bias

For optimal performance the analog inputs should be driven differentially. Each input should swing  $\pm 0.5V$  for the 2V range or  $\pm 0.25V$  for the 1V range, around a common mode voltage of 1.5V. The  $V_{CM}$  output pin (Pin 31) may be used to provide the common mode bias level.  $V_{CM}$  can be tied directly to the center tap of a transformer to set the DC input level or as a reference level to an op amp differential driver circuit. The  $V_{CM}$  pin must be bypassed to ground close to the ADC with a 2.2 $\mu F$  or greater capacitor.

### Input Drive Impedance

As with all high performance, high speed ADCs, the dynamic performance of the LTC2229 can be influenced by the input drive circuitry, particularly the second and third harmonics. Source impedance and reactance can influence SFDR. At the falling edge of CLK, the sample-and-hold circuit will connect the 4pF sampling capacitor to the input pin and start the sampling period. The sampling period ends when CLK rises, holding the sampled input on the sampling capacitor. Ideally the input circuitry should be fast enough to fully charge the sampling capacitor during the sampling period  $1/(2F_{ENCODE})$ ; however, this is not always possible and the incomplete settling may degrade the SFDR. The sampling glitch has been designed to be as linear as possible to minimize the effects of incomplete settling.

For the best performance, it is recommended to have a source impedance of 100 $\Omega$  or less for each input. The source impedance should be matched for the differential inputs. Poor matching will result in higher even order harmonics, especially the second.

### Input Drive Circuits

Figure 3 shows the LTC2229 being driven by an RF transformer with a center tapped secondary. The secondary center tap is DC biased with  $V_{CM}$ , setting the ADC input signal at its optimum DC level. Terminating on the transformer secondary is desirable, as this provides a common mode path for charging glitches caused by the sample and hold. Figure 3 shows a 1:1 turns ratio transformer. Other turns ratios can be used if the source impedance seen by the ADC does not exceed 100 $\Omega$  for each ADC input. A disadvantage of using a transformer is the loss of low frequency response. Most small RF transformers have poor performance at frequencies below 1MHz.

Figure 4 demonstrates the use of a differential amplifier to convert a single ended input signal into a differential input signal. The advantage of this method is that it provides low frequency input response; however, the limited gain bandwidth of most op amps will limit the SFDR at high input frequencies.

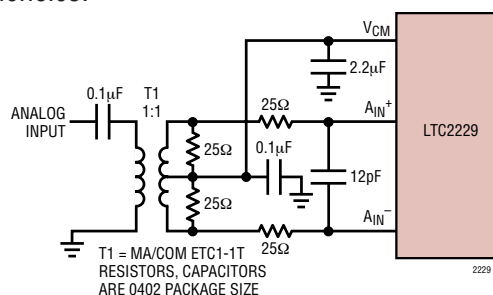

Figure 3. Single-Ended to Differential Conversion Using a Transformer

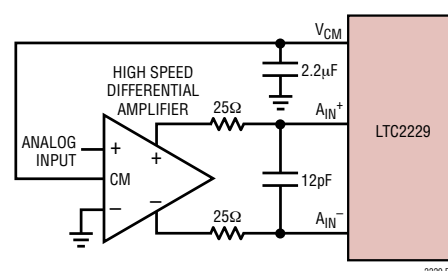
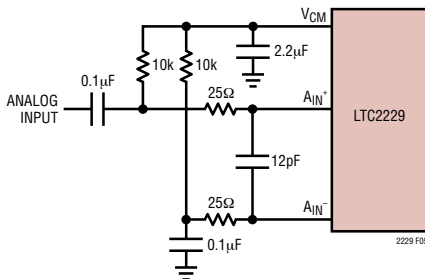

Figure 4. Differential Drive with an Amplifier

## APPLICATIONS INFORMATION

Figure 5 shows a single-ended input circuit. The impedance seen by the analog inputs should be matched. This circuit is not recommended if low distortion is required.



**Figure 5. Single-Ended Drive**

The 25Ω resistors and 12pF capacitor on the analog inputs serve two purposes: isolating the drive circuitry from the sample-and-hold charging glitches and limiting the wideband noise at the converter input.

For input frequencies above 70MHz, the input circuits of Figure 6, 7 and 8 are recommended. The balun transformer gives better high frequency response than a flux coupled center tapped transformer. The coupling capacitors allow the analog inputs to be DC biased at 1.5V. In Figure 8, the series inductors are impedance matching elements that maximize the ADC bandwidth.

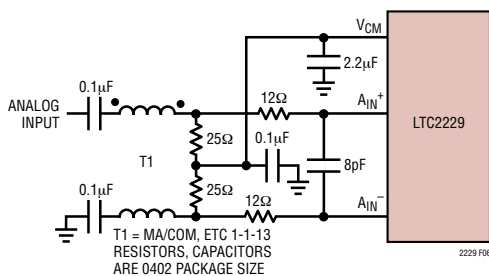

**Figure 6. Recommended Front End Circuit for Input Frequencies Between 70MHz and 170MHz**

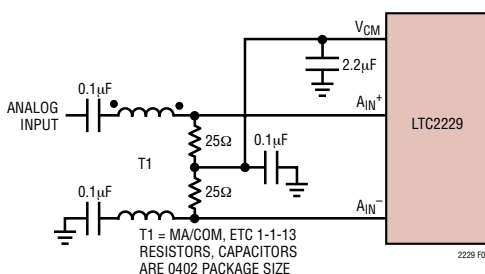

**Figure 7. Recommended Front End Circuit for Input Frequencies Between 170MHz and 300MHz**

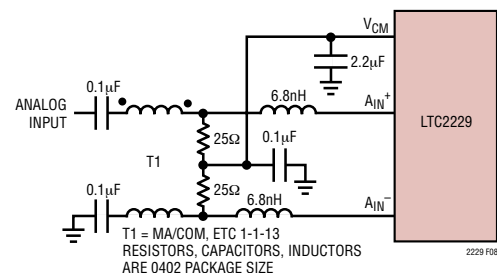

**Figure 8. Recommended Front End Circuit for Input Frequencies Above 300MHz**

### Reference Operation

Figure 9 shows the LTC2229 reference circuitry consisting of a 1.5V bandgap reference, a difference amplifier and switching and control circuit. The internal voltage reference can be configured for two pin selectable input ranges of 2V ( $\pm 1V$  differential) or 1V ( $\pm 0.5V$  differential). Tying the SENSE pin to  $V_{DD}$  selects the 2V range; tying the SENSE pin to  $V_{CM}$  selects the 1V range.

The 1.5V bandgap reference serves two functions: its output provides a DC bias point for setting the common mode voltage of any external input circuitry; additionally, the reference is used with a difference amplifier to generate the differential reference levels needed by the internal ADC circuitry. An external bypass capacitor is required for the 1.5V reference output,  $V_{CM}$ . This provides a high frequency low impedance path to ground for internal and external circuitry.

The difference amplifier generates the high and low reference for the ADC. High speed switching circuits are connected to these outputs and they must be externally bypassed. Each output has two pins. The multiple output pins are needed to reduce package inductance. Bypass capacitors must be connected as shown in Figure 9.

Other voltage ranges in-between the pin selectable ranges can be programmed with two external resistors as shown in Figure 10. An external reference can be used by applying its output directly or through a resistor divider to SENSE. It is not recommended to drive the SENSE pin with a logic device. The SENSE pin should be tied to the appropriate level as close to the converter as possible. If the SENSE pin is driven externally, it should be bypassed to ground as close to the device as possible with a 1µF ceramic capacitor.



## APPLICATIONS INFORMATION

The lower limit of the LTC2229 sample rate is determined by droop of the sample-and-hold circuits. The pipelined architecture of this ADC relies on storing analog signals on small valued capacitors. Junction leakage will discharge the capacitors. The specified minimum operating frequency for the LTC2229 is 1Msps.

### DIGITAL OUTPUTS

#### Digital Output Buffers

Figure 12 shows an equivalent circuit for a single output buffer. Each buffer is powered by  $OV_{DD}$  and  $OGND$ , isolated from the ADC power and ground. The additional N-channel transistor in the output driver allows operation down to low voltages. The internal resistor in series with the output makes the output appear as  $50\Omega$  to external circuitry and may eliminate the need for external damping resistors.

As with all high speed/high resolution converters, the digital output loading can affect the performance. The digital outputs of the LTC2229 should drive a minimal capacitive load to avoid possible interaction between the digital outputs and sensitive input circuitry. The output should be buffered with a device such as an ALVCH16373 CMOS latch. For full speed operation the capacitive load should be kept under 10pF.

Lower  $OV_{DD}$  voltages will also help reduce interference from the digital outputs.

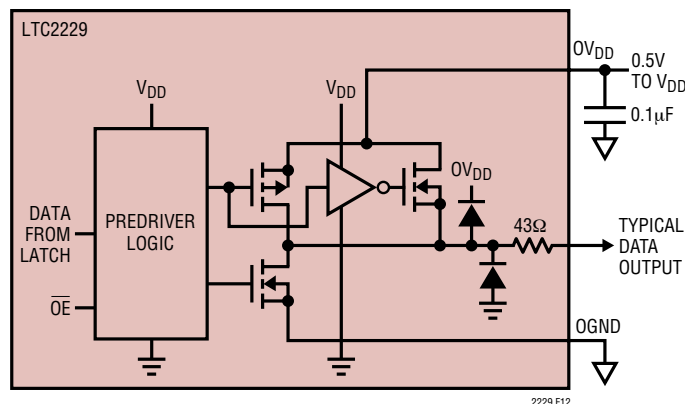

Figure 12. Digital Output Buffer

#### Data Format

Using the MODE pin, the LTC2229 parallel digital output can be selected for offset binary or 2's complement format. Connecting MODE to GND or  $1/3V_{DD}$  selects straight binary output format. Connecting MODE to  $2/3V_{DD}$  or  $V_{DD}$  selects 2's complement output format. An external resistor divider can be used to set the  $1/3V_{DD}$  or  $2/3V_{DD}$  logic values. Table 1 shows the logic states for the MODE pin.

Table 1. MODE Pin Function

MODE Pin	Output Format	Clock Duty Cycle Stabilizer
0	Straight Binary	Off
$1/3V_{DD}$	Straight Binary	On
$2/3V_{DD}$	2's Complement	On
$V_{DD}$	2's Complement	Off

#### Overflow Bit

When OF outputs a logic high the converter is either overranged or underranged.

#### Output Driver Power

Separate output power and ground pins allow the output drivers to be isolated from the analog circuitry. The power supply for the digital output buffers,  $OV_{DD}$ , should be tied to the same power supply as for the logic being driven. For example if the converter is driving a DSP powered by a 1.8V supply, then  $OV_{DD}$  should be tied to that same 1.8V supply.

$OV_{DD}$  can be powered with any voltage from 500mV up to the  $V_{DD}$  of the part.  $OGND$  can be powered with any voltage from GND up to 1V and must be less than  $OV_{DD}$ . The logic outputs will swing between  $OGND$  and  $OV_{DD}$ .

#### Output Enable

The outputs may be disabled with the output enable pin,  $\overline{OE}$ .  $\overline{OE}$  high disables all data outputs including OF. The data access and bus relinquish times are too slow to allow the outputs to be enabled and disabled during full speed operation. The output Hi-Z state is intended for use during long periods of inactivity.

## APPLICATIONS INFORMATION

### Sleep and Nap Modes

The converter may be placed in shutdown or nap modes to conserve power. Connecting SHDN to GND results in normal operation. Connecting SHDN to  $V_{DD}$  and  $\overline{OE}$  to  $V_{DD}$  results in sleep mode, which powers down all circuitry including the reference and typically dissipates 1mW. When exiting sleep mode it will take milliseconds for the output data to become valid because the reference capacitors have to recharge and stabilize. Connecting SHDN to  $V_{DD}$  and  $\overline{OE}$  to GND results in nap mode, which typically dissipates 15mW. In nap mode, the on-chip reference circuit is kept on, so that recovery from nap mode is faster than that from sleep mode, typically taking 100 clock cycles. In both sleep and nap modes, all digital outputs are disabled and enter the Hi-Z state.

### Grounding and Bypassing

The LTC2229 requires a printed circuit board with a clean, unbroken ground plane. A multilayer board with an internal ground plane is recommended. Layout for the printed circuit board should ensure that digital and analog signal lines are separated as much as possible. In particular, care should be taken not to run any digital track alongside an analog signal track or underneath the ADC.

High quality ceramic bypass capacitors should be used at the  $V_{DD}$ ,  $OV_{DD}$ ,  $V_{CM}$ , REFH, and REFL pins. Bypass capacitors must be located as close to the pins as possible. Of particular importance is the 0.1 $\mu$ F capacitor between REFH and REFL. This capacitor should be placed as close to the device as possible (1.5mm or less). A size 0402 ceramic capacitor is recommended. The large 2.2 $\mu$ F capacitor between REFH and REFL can be somewhat further away. The traces connecting the pins and bypass capacitors must be kept short and should be made as wide as possible.

The LTC2229 differential inputs should run parallel and close to each other. The input traces should be as short as possible to minimize capacitance and to minimize noise pickup.

### Heat Transfer

Most of the heat generated by the LTC2229 is transferred from the die through the bottom-side exposed pad and package leads onto the printed circuit board. For good electrical and thermal performance, the exposed pad should be soldered to a large grounded pad on the PC board. It is critical that all ground pins are connected to a ground plane of sufficient area.

# APPLICATIONS INFORMATION

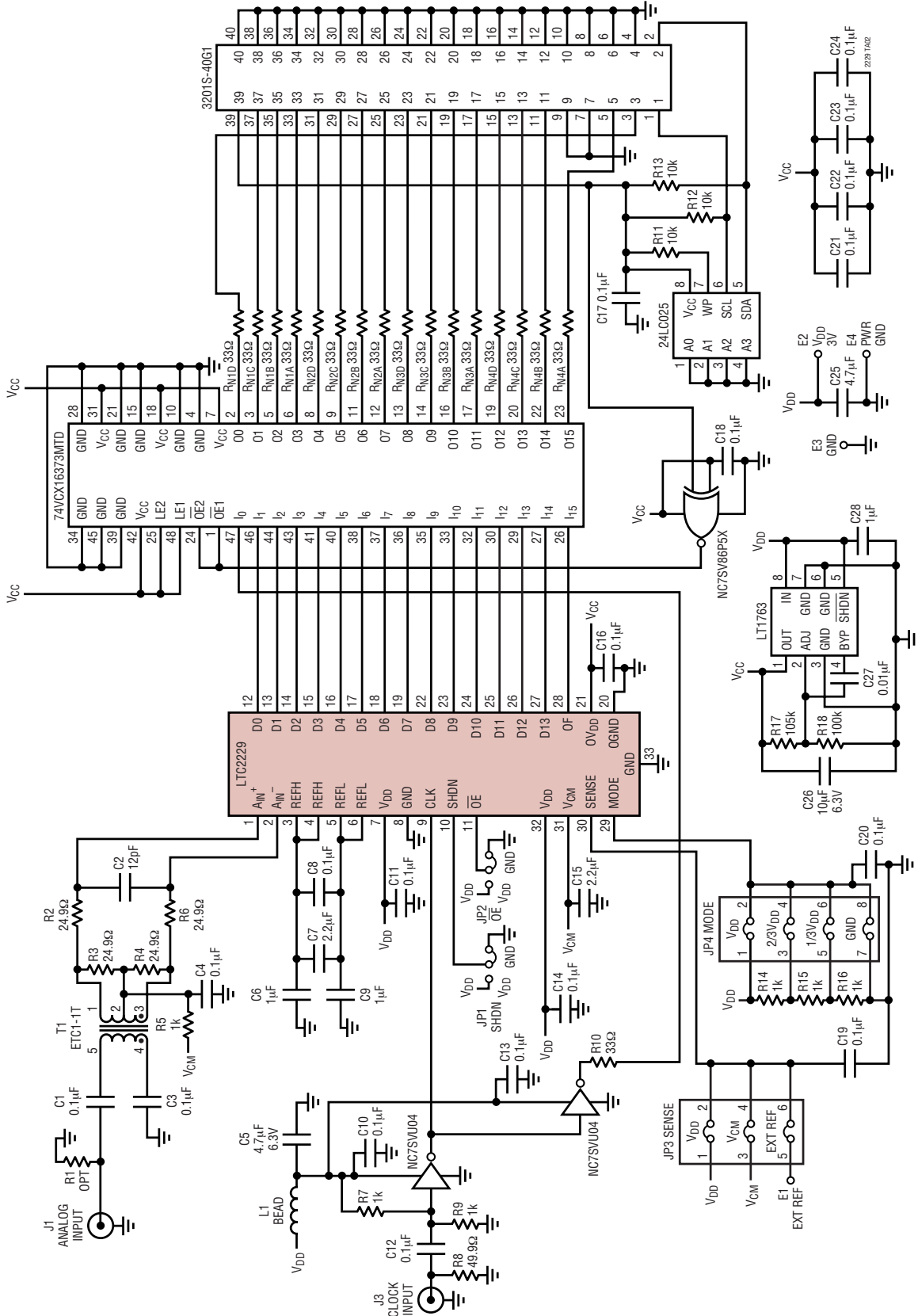

# APPLICATIONS INFORMATION

Silkscreen Top

Topside

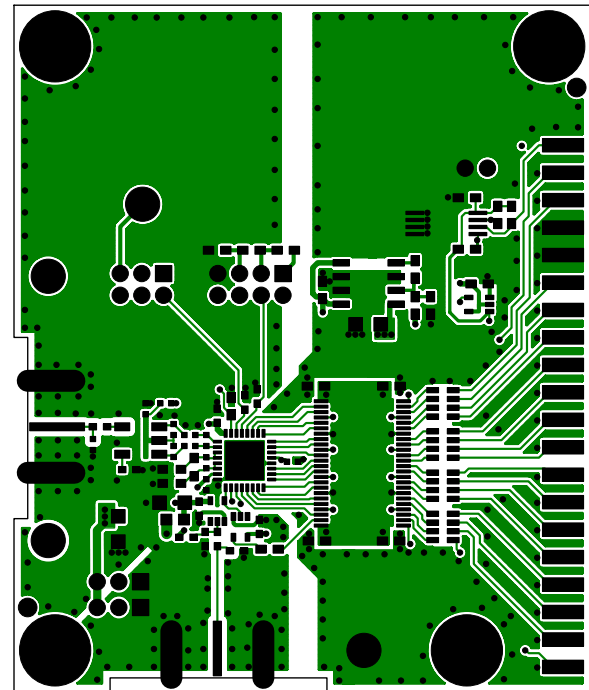
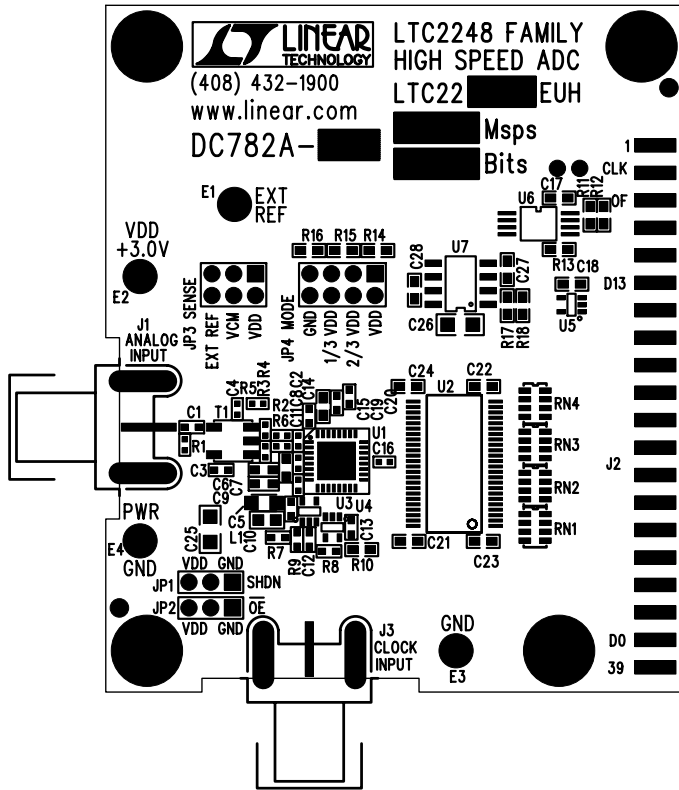

Inner Layer 2 GND

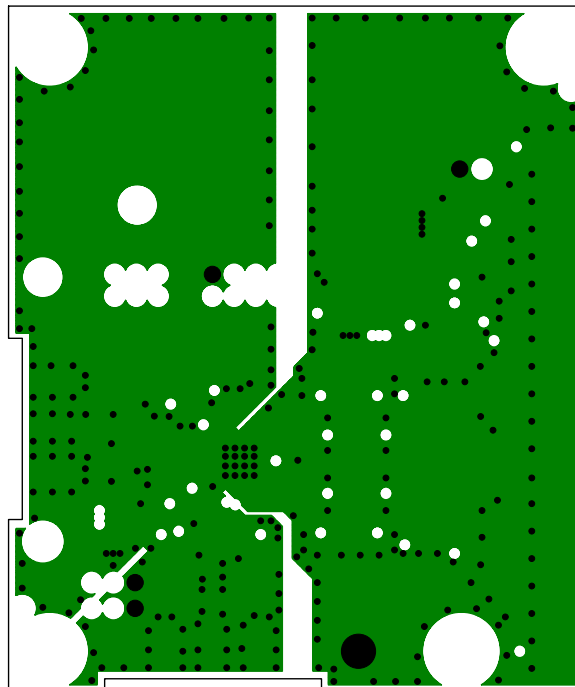

# APPLICATIONS INFORMATION

Inner Layer 3 Power

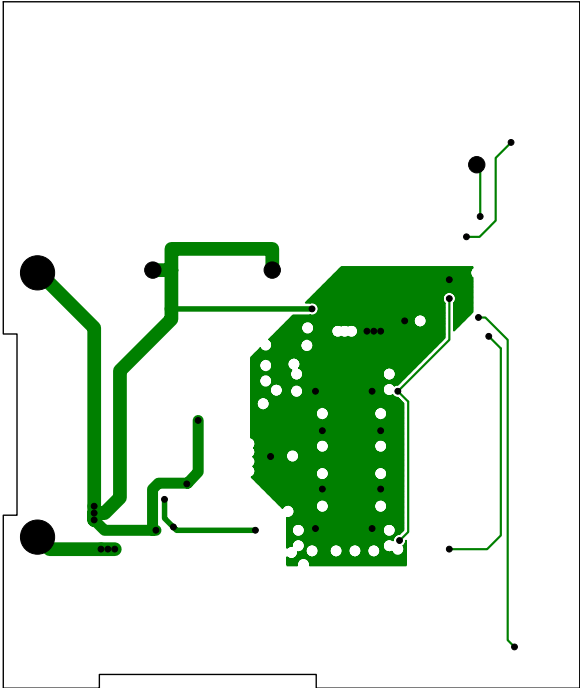

Bottomside

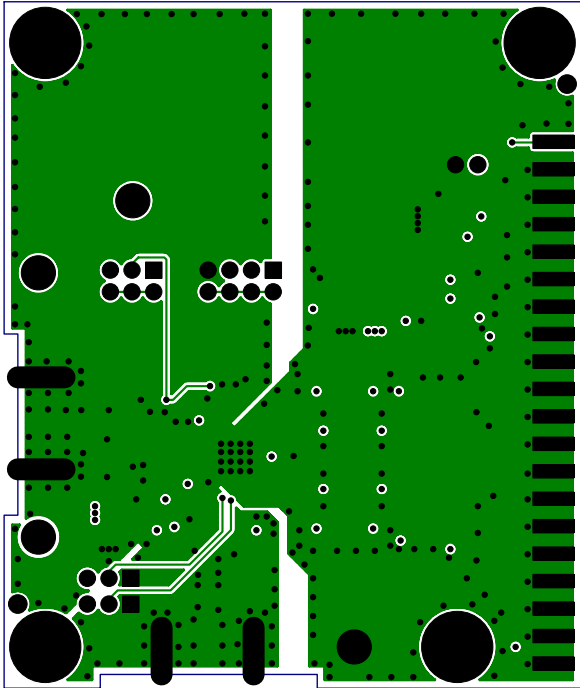

Silkscreen Bottom

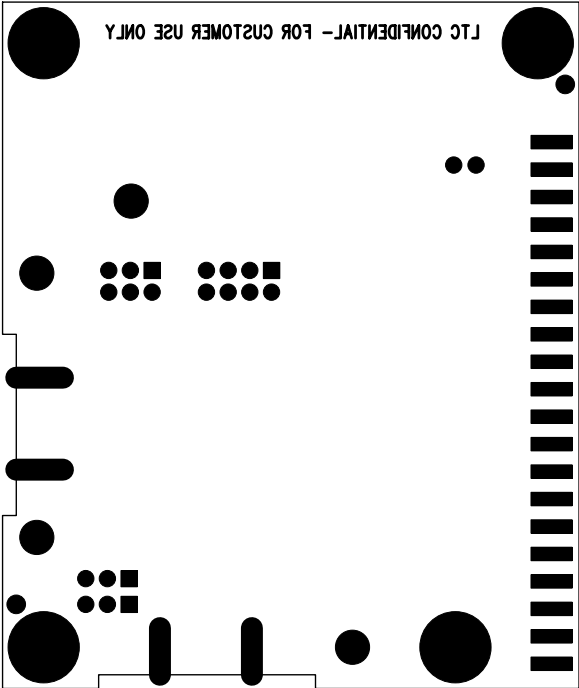

## PACKAGE DESCRIPTION

**UH Package**  
**32-Lead Plastic QFN (5mm × 5mm)**  
 (Reference LTC DWG # 05-08-1693)

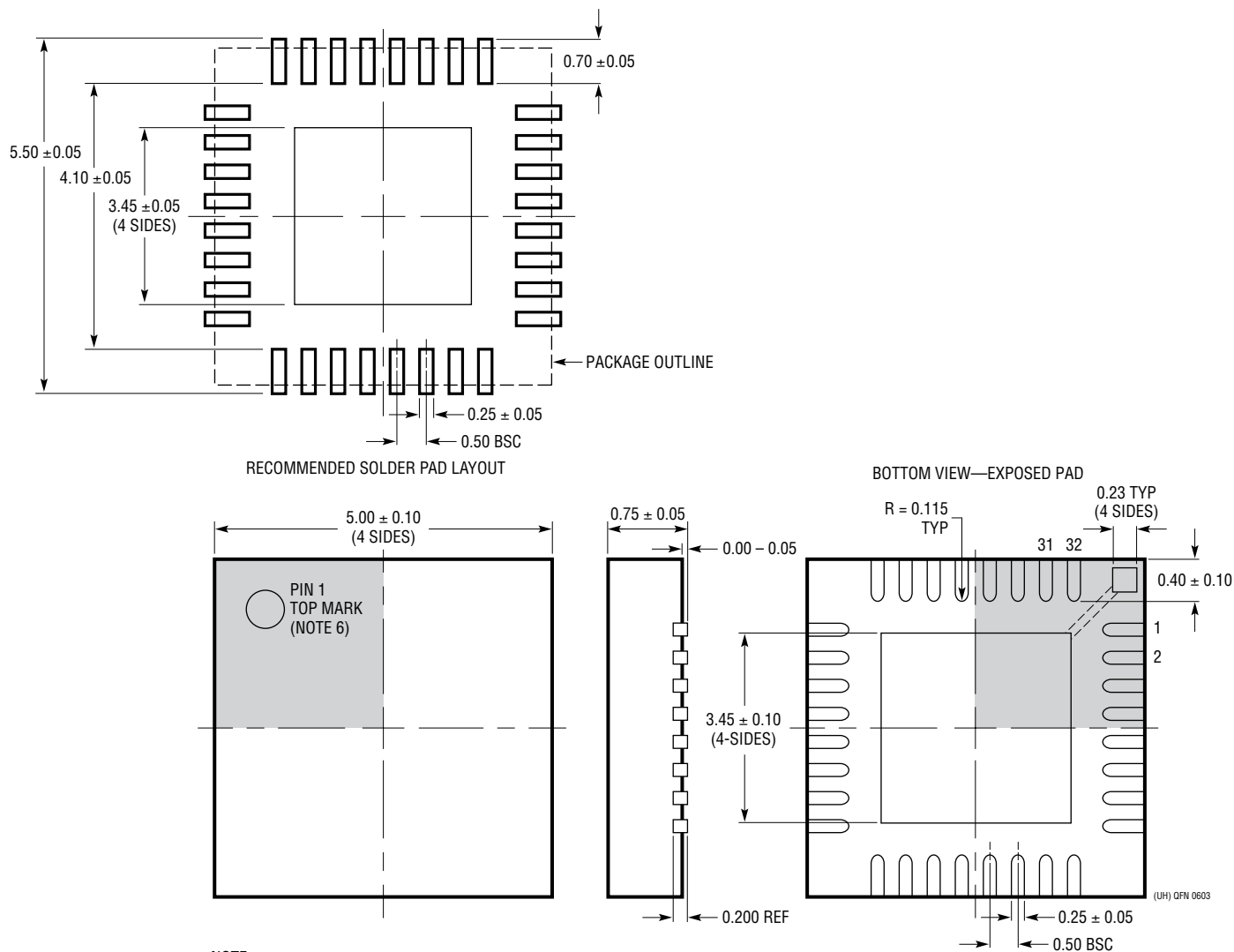

**NOTE:**

1. DRAWING PROPOSED TO BE A JEDEC PACKAGE OUTLINE MO-220 VARIATION WHHD-(X) (TO BE APPROVED)
2. DRAWING NOT TO SCALE
3. ALL DIMENSIONS ARE IN MILLIMETERS
4. DIMENSIONS OF EXPOSED PAD ON BOTTOM OF PACKAGE DO NOT INCLUDE MOLD FLASH. MOLD FLASH, IF PRESENT, SHALL NOT EXCEED 0.20mm ON ANY SIDE
5. EXPOSED PAD SHALL BE SOLDER PLATED
6. SHADED AREA IS ONLY A REFERENCE FOR PIN 1 LOCATION ON THE TOP AND BOTTOM OF PACKAGE

## RELATED PARTS

PART NUMBER	DESCRIPTION	COMMENTS
LTC1741	12-Bit, 65Msps ADC	72dB SNR, 87dB SFDR, 48-Pin TSSOP Package
LTC1742	14-Bit, 65Msps ADC	76.5dB SNR, 90dB SFDR, 48-Pin TSSOP Package
LTC1743	12-Bit, 50Msps ADC	72.5dB SNR, 90dB SFDR, 48-Pin TSSOP Package
LTC1744	14-Bit, 50Msps ADC	77dB SNR, 90dB SFDR, 48-Pin TSSOP Package
LTC1745	12-Bit, 25Msps ADC	72.2dB SNR, 380mW SFDR, 48-Pin TSSOP Package
LTC1746	14-Bit, 25Msps ADC	77.5dB SNR, 390mW SFDR, 48-Pin TSSOP Package
LTC1747	12-Bit, 80Msps ADC	72dB SNR, 87dB SFDR, 48-Pin TSSOP Package
LTC1748	14-Bit, 80Msps ADC	76.3dB SNR, 90dB SFDR, 48-Pin TSSOP Package
LTC1749	12-Bit, 80Msps Wideband ADC	Up to 500MHz IF Undersampling, 87dB SFDR
LTC1750	14-Bit, 80Msps Wideband ADC	Up to 500MHz IF Undersampling, 90dB SFDR
LTC2220	12-Bit, 170Msps ADC	890mW, 67.7dB SNR, 9mm × 9mm QFN Package
LTC2221	12-Bit, 135Msps ADC	630mW, 67.8dB SNR, 9mm × 9mm QFN Package
LTC2222	12-Bit, 105Msps ADC	475mW, 68.4dB SNR, 7mm × 7mm QFN Package
LTC2223	12-Bit, 80Msps ADC	366mW, 68.5dB SNR, 7mm × 7mm QFN Package
LTC2224	12-Bit, 135Msps ADC	630mW, 67.6dB SNR, 7mm × 7mm QFN Package
LTC2225	12-Bit, 10Msps ADC	60mW, 71.3dB SNR, 5mm × 5mm QFN Package
LTC2226	12-Bit, 25Msps ADC	75mW, 71.4dB SNR, 5mm × 5mm QFN Package
LTC2227	12-Bit, 40Msps ADC	120mW, 71.4dB SNR, 5mm × 5mm QFN Package
LTC2228	12-Bit, 65Msps ADC	205mW, 71.3dB SNR, 5mm × 5mm QFN Package
LTC2230	10-Bit, 170Msps ADC	890mW, 61.2dB SNR, 9mm × 9mm QFN Package
LTC2231	10-Bit, 135Msps ADC	630mW, 61.2dB SNR, 9mm × 9mm QFN Package
LTC2232	10-Bit, 105Msps ADC	475mW, 61.3dB SNR, 7mm × 7mm QFN Package
LTC2233	10-Bit, 80Msps ADC	366mW, 61.3dB SNR, 7mm × 7mm QFN Package
LTC2234	10-Bit, 135Msps ADC	630mW, 61.2dB SNR, 7mm × 7mm QFN Package
LTC2236	10-Bit, 25Msps ADC	75mW, 61.8dB SNR, 5mm × 5mm QFN Package
LTC2237	10-Bit, 40Msps ADC	120mW, 61.8dB SNR, 5mm × 5mm QFN Package
LTC2238	10-Bit, 65Msps ADC	205mW, 61.8dB SNR, 5mm × 5mm QFN Package
LTC2239	10-Bit, 80Msps ADC	211mW, 61.6dB SNR, 5mm × 5mm QFN Package
LTC2245	14-Bit, 10Msps ADC	60mW, 74.4dB SNR, 5mm × 5mm QFN Package
LTC2246	14-Bit, 25Msps ADC	75mW, 74.5dB SNR, 5mm × 5mm QFN Package
LTC2247	14-Bit, 40Msps ADC	120mW, 74.4dB SNR, 5mm × 5mm QFN Package
LTC2248	14-Bit, 65Msps ADC	205mW, 74.3dB SNR, 5mm × 5mm QFN Package
LTC2249	14-Bit, 80Msps ADC	222mW, 73dB SNR, 5mm × 5mm QFN Package
LT5512	DC-3GHz High Signal Level Downconverting Mixer	DC to 3GHz, 21dBm IIP3, Integrated LO Buffer
LT5514	Ultralow Distortion IF Amplifier/ADC Driver with Digitally Controlled Gain	450MHz 1dB BW, 47dB OIP3, Digital Gain Control 10.5dB to 33dB in 1.5dB/Step
LT5515	1.5GHz to 2.5GHz Direct Conversion Quadrature Demodulator	20dBm IIP3, Integrated LO Quadrature Generator
LT5516	0.8GHz to 1.5GHz Direct Conversion Quadrature Demodulator	21.5dBm IIP3, Integrated LO Quadrature Generator
LT5517	40MHz to 900MHz Direct Conversion Quadrature Demodulator	21dBm IIP3, Integrated LO Quadrature Generator
LT5522	600MHz to 2.7GHz High Linearity Downconverting Mixer	4.5V to 5.25V Supply, 25dBm IIP3 at 900MHz, NF = 12.5dB, 50Ω Single-Ended RF and LO Ports