



# LT5528

## 1.5GHz to 2.4GHz High Linearity Direct Quadrature Modulator

### FEATURES

- Direct Conversion to 1.5GHz to 2.4GHz
- High OIP3: 21.8dBm at 2GHz
- Low Output Noise Floor at 5MHz Offset:  
No RF: -159.3dBm/Hz  
 $P_{OUT} = 4\text{dBm}$ : -151.8dBm/Hz
- 4-Ch W-CDMA ACPR: -66dBc at 2.14GHz
- Integrated LO Buffer and LO Quadrature Phase Generator
- 50Ω AC-Coupled Single-Ended LO and RF Ports
- 50Ω DC Interface to Baseband Inputs
- Low Carrier Leakage: -42dBm at 2GHz
- High Image Rejection: 45dB at 2GHz
- 16-Lead QFN 4mm × 4mm Package

### APPLICATIONS

- Infrastructure Tx for DCS, PCS and UMTS Bands
- Image Reject Up-Converters for PCS and UMTS Bands
- Low-Noise Variable Phase-Shifter for 1.5GHz to 2.4GHz Local Oscillator Signals

### DESCRIPTION

The LT<sup>®</sup>5528 is a direct I/Q modulator designed for high performance wireless applications, including wireless infrastructure. It allows direct modulation of an RF signal using differential baseband I and Q signals. It supports PHS, GSM, EDGE, TD-SCDMA, CDMA, CDMA2000, W-CDMA and other systems. It may also be configured as an image reject up-converting mixer, by applying 90° phase-shifted signals to the I and Q inputs. The I/Q baseband inputs consist of voltage-to-current converters that in turn drive double-balanced mixers. The outputs of these mixers are summed and applied to an on-chip RF transformer, which converts the differential mixer signals to a 50Ω single-ended output. The four balanced I and Q baseband input ports are intended for DC coupling from a source with a common-mode voltage level of about 0.5V. The LO path consists of an LO buffer with single-ended input, and precision quadrature generators that produce the LO drive for the mixers. The supply voltage range is 4.5V to 5.25V.

LT, LTC and LT are registered trademarks of Linear Technology Corporation.

### TYPICAL APPLICATION

1.5GHz to 2.4GHz Direct Conversion Transmitter Application  
with LO Feed-Through and Image Calibration Loop

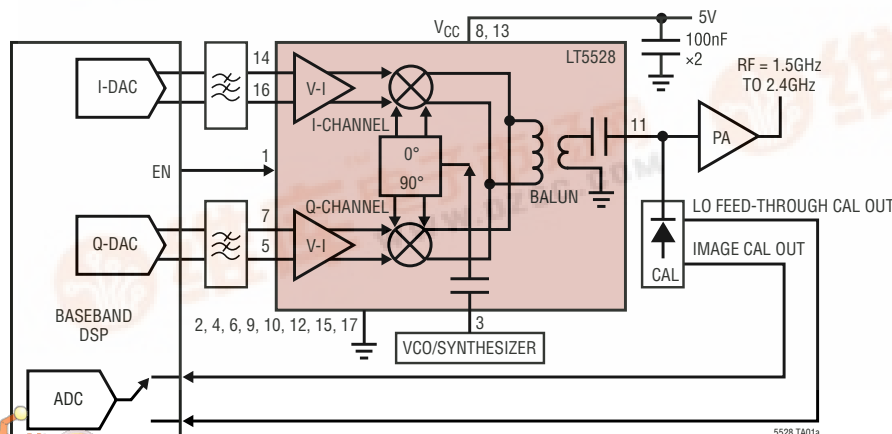

W-CDMA ACPR, AICPR and Noise vs RF Output  
Power at 2140MHz for 1, 2 and 4 Channels

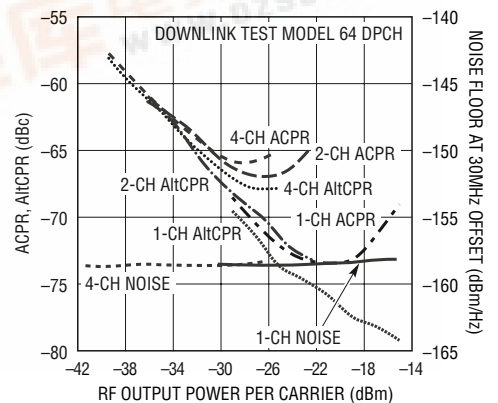

# LT5528

## ABSOLUTE MAXIMUM RATINGS

(Note 1)

Supply Voltage .....	5.5V
Common-Mode Level of BBPI, BBMI and BBPQ, BBMQ .....	2.5V
Operating Ambient Temperature (Note 2) .....	-40°C to 85°C
Storage Temperature Range.....	-65°C to 125°C
Voltage on Any Pin Not to Exceed.....	-500mV to $V_{CC} + 500mV$

## PACKAGE/ORDER INFORMATION

<p>TOP VIEW</p> <p>16-LEAD (4mm x 4mm) PLASTIC QFN  <math>T_{JMAX} = 125^{\circ}C</math>, <math>\theta_{JA} = 37^{\circ}C/W</math>            EXPOSED PAD IS GROUND (PIN 17)            MUST BE SOLDERED TO PCB.</p>	ORDER PART NUMBER
	LT5528EUF
	UF PART MARKING
	5528A

Consult LTC Marketing for parts specified with wider operating temperature ranges.

## ELECTRICAL CHARACTERISTICS

$V_{CC} = 5V$ , EN = High,  $T_A = 25^{\circ}C$ ,  $f_{LO} = 2GHz$ ,  $f_{RF} = 2.002GHz$ ,  $P_{LO} = 0dBm$ .  
 BBPI, BBMI, BBPQ, BBMQ inputs  $0.525V_{DC}$ , Baseband Input Frequency = 2MHz, I&Q 90° shifted (upper sideband selection).  
 $P_{RF, OUT} = -10dBm$ , unless otherwise noted. (Note 3)

SYMBOL	PARAMETER	CONDITIONS	MIN	TYP	MAX	UNITS
<b>RF Output (RF)</b>						
$f_{RF}$	RF Frequency Range	-3dB Bandwidth		1.5 to 2.4		GHz
	RF Frequency Range	-1dB Bandwidth		1.7 to 2.2		GHz
$S_{22, ON}$	RF Output Return Loss	EN = High (Note 6)		-15		dB
$S_{22, OFF}$	RF Output Return Loss	EN = Low (Note 6)		-12		dB
NFloor	RF Output Noise Floor	No Input Signal (Note 8) $P_{OUT} = 4dBm$ (Note 9) $P_{OUT} = 4dBm$ (Note 10)		-159.3 -151.8 -151.8		dBm/Hz dBm/Hz dBm/Hz
$G_p$	Conversion Power Gain	$P_{OUT}/P_{IN, I\&Q}$		-6.5		dB
$G_v$	Conversion Voltage Gain	$20 \cdot \log(V_{OUT, 50\Omega}/V_{IN, DIFF, I \text{ or } Q})$		-6		dB
$P_{OUT}$	Absolute Output Power	$1V_{P-P, DIFF}$ CW Signal, I and Q		-2.1		dBm
$G_{3LO \text{ vs } LO}$	3 • LO Conversion Gain Difference	(Note 17)		-28		dB
OP1dB	Output 1dB Compression	(Note 7)		7.9		dBm
OIP2	Output 2nd Order Intercept	(Notes 13, 14)		49		dBm
OIP3	Output 3rd Order Intercept	(Notes 13, 15)		21.8		dBm
IR	Image Rejection	(Note 16)		-45		dBc
LOFT	Carrier Leakage (LO Feed-Through)	EN = High, $P_{LO} = 0dBm$ (Note 16) EN = Low, $P_{LO} = 0dBm$ (Note 16)		-42 -57.8		dBm dBm
<b>LO Input (LO)</b>						
$f_{LO}$	LO Frequency Range			1.5 to 2.4		GHz
$P_{LO}$	LO Input Power		-10	0	5	dBm
$S_{11, ON}$	LO Input Return Loss	EN = High (Note 6)		-17		dB
$S_{11, OFF}$	LO Input Return Loss	EN = Low (Note 6)		-5.5		dB
$NF_{LO}$	LO Input Referred Noise Figure	(Note 5) at 2GHz		14.4		dB
$G_{LO}$	LO to RF Small Signal Gain	(Note 5) at 2GHz		20.4		dB
IIP3 <sub>LO</sub>	LO Input 3rd Order Intercept	(Note 5) at 2GHz		-10		dBm

## ELECTRICAL CHARACTERISTICS

$V_{CC} = 5V$ , EN = High,  $T_A = 25^\circ C$ ,  $f_{LO} = 2GHz$ ,  $f_{RF} = 2.002GHz$ ,  $P_{LO} = 0dBm$ .  
 BBPI, BBMI, BBPQ, BBMQ inputs  $0.525V_{DC}$ , Baseband Input Frequency = 2MHz, I&Q 90° shifted (upper sideband selection).  
 $P_{RF, OUT} = -10dBm$ , unless otherwise noted. (Note 3)

SYMBOL	PARAMETER	CONDITIONS	MIN	TYP	MAX	UNITS
<b>Baseband Inputs (BBPI, BBMI, BBPQ, BBMQ)</b>						
$BW_{BB}$	Baseband Bandwidth	-3dB Bandwidth		400		MHz
$V_{CMBB}$	DC Common Mode Voltage	(Note 4)		0.525		V
$R_{IN, SE}$	Single-Ended Input Resistance	(Note 4)		45		$\Omega$
$P_{LO2BB}$	Carrier Feed-Through on BB	$P_{OUT} = 0$ (Note 4)		-40		dBm
IP1dB	Input 1dB Compression Point	Differential Peak-to-Peak (Note 7)		3.2		$V_{P-P, DIFF}$
$\Delta G_{I/Q}$	I/Q Absolute Gain Imbalance			0.05		dB
$\Delta \phi_{I/Q}$	I/Q Absolute Phase Imbalance			0.5		Deg
<b>Power Supply (<math>V_{CC}</math>)</b>						
$V_{CC}$	Supply Voltage		4.5	5	5.25	V
$I_{CC, ON}$	Supply Current	EN = High		125	145	mA
$I_{CC, OFF}$	Supply Current, Sleep Mode	EN = 0V		0.05	50	$\mu A$
$t_{ON}$	Turn-On Time	EN = Low to High (Note 11)		0.25		$\mu s$
$t_{OFF}$	Turn-Off Time	EN = High to Low (Note 12)		1.3		$\mu s$
<b>Enable (EN), Low = Off, High = On</b>						
Enable	Input High Voltage	EN = High	1.0			V
	Input High Current	EN = 5V		240		$\mu A$
Sleep	Input Low Voltage	EN = Low			0.5	V

**Note 1:** Absolute Maximum Ratings are those values beyond which the life of a device may be impaired.

**Note 2:** Specifications over the  $-40^\circ C$  to  $85^\circ C$  temperature range are assured by design, characterization and correlation with statistical process controls.

**Note 3:** Tests are performed as shown in the configuration of Figure 7.

**Note 4:** On each of the four baseband inputs BBPI, BBMI, BBPQ and BBMQ.

**Note 5:**  $V(BBPI) - V(BBMI) = 1V_{DC}$ ,  $V(BBPQ) - V(BBMQ) = 1V_{DC}$ .

**Note 6:** Maximum value within -1dB bandwidth.

**Note 7:** An external coupling capacitor is used in the RF output line.

**Note 8:** At 20MHz offset from the LO signal frequency.

**Note 9:** At 20MHz offset from the CW signal frequency.

**Note 10:** At 5MHz offset from the CW signal frequency.

**Note 11:** RF power is within 10% of final value.

**Note 12:** RF power is at least 30dB lower than in the ON state.

**Note 13:** Baseband is driven by 2MHz and 2.1MHz tones. Drive level is set in such a way that the two resulting RF tones are -10dBm each.

**Note 14:** IM2 measured at LO frequency + 4.1MHz.

**Note 15:** IM3 measured at LO frequency + 1.9MHz and LO frequency + 2.2MHz.

**Note 16:** Amplitude average of the characterization data set without image or LO feed-through nulling (unadjusted).

**Note 17:** The difference in conversion gain between the spurious signal at  $f = 3 \cdot LO - BB$  versus the conversion gain at the desired signal at  $f = LO + BB$  for  $BB = 2MHz$  and  $LO = 2GHz$ .

**TYPICAL PERFORMANCE CHARACTERISTICS**  $V_{CC} = 5V$ ,  $EN = High$ ,  $T_A = 25^\circ C$ ,  $f_{LO} = 2.14GHz$ ,  $P_{LO} = 0dBm$ . BBPI, BBMI, BBPQ, BBMQ inputs  $0.525V_{DC}$ , Baseband Input Frequency  $f_{BB} = 2MHz$ , I&Q  $90^\circ$  shifted.  $f_{RF} = f_{BB} + f_{LO}$  (upper sideband selection).  $P_{RF, OUT} = -10dBm$  ( $-10dBm/$ tone for 2-tone measurements), unless otherwise noted. (Note 3)

Supply Current vs Supply Voltage

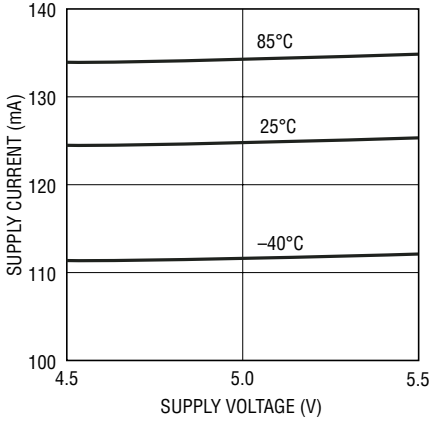

5528 G01

Gain and Output 1dB Compression vs LO Frequency and Temperature

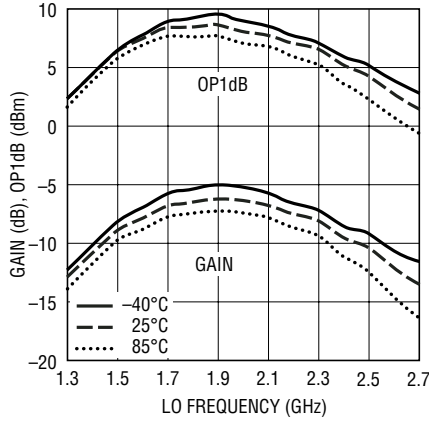

5528 G02

Gain and Output 1dB Compression vs LO Frequency and Supply Voltage

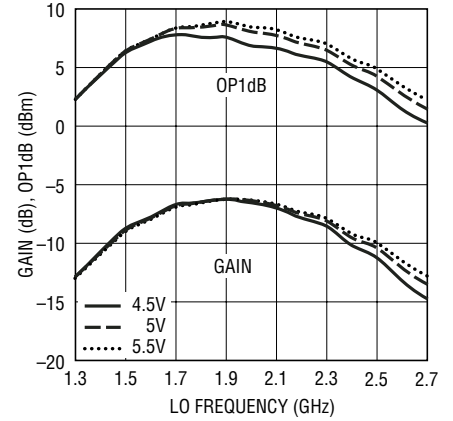

5528 G03

Output IP3 and Noise Floor vs LO Frequency and Temperature

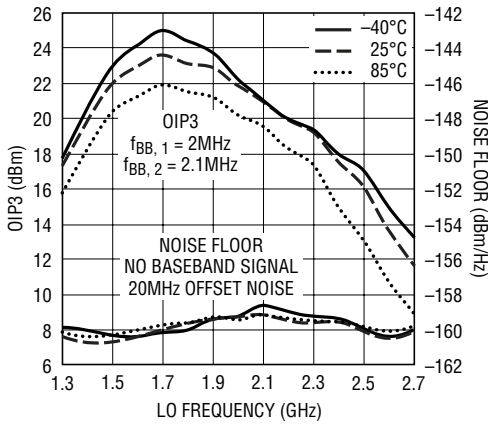

5528 G04

Output IP3 and Noise Floor vs LO Frequency and Supply Voltage

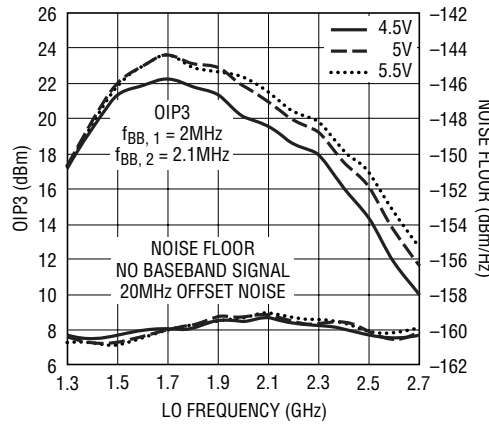

5528 G05

Output IP2 vs LO Frequency

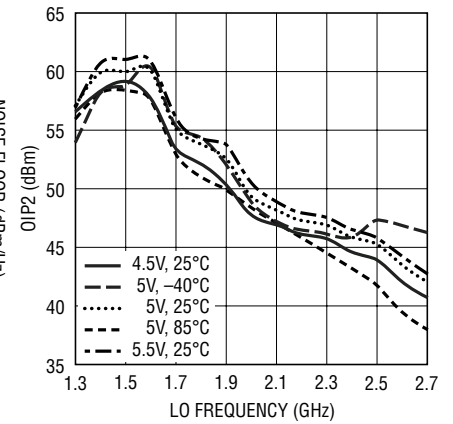

5528 G06

**TYPICAL PERFORMANCE CHARACTERISTICS**  $V_{CC} = 5V$ ,  $EN = High$ ,  $T_A = 25^\circ C$ ,  $f_{LO} = 2.14GHz$ ,  $P_{LO} = 0dBm$ . BBPI, BBMI, BBPQ, BBMQ inputs  $0.525V_{DC}$ , Baseband Input Frequency  $f_{BB} = 2MHz$ , I&Q  $90^\circ$  shifted.  $f_{RF} = f_{BB} + f_{LO}$  (upper sideband selection).  $P_{RF, OUT} = -10dBm$  ( $-10dBm/$ tone for 2-tone measurements), unless otherwise noted. (Note 3)

**2 • LO Leakage to RF Output vs 2 • LO Frequency**

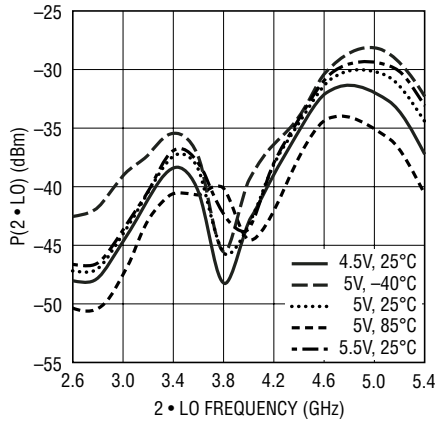

5528 G07

**3 • LO Leakage to RF Output vs 3 • LO Frequency**

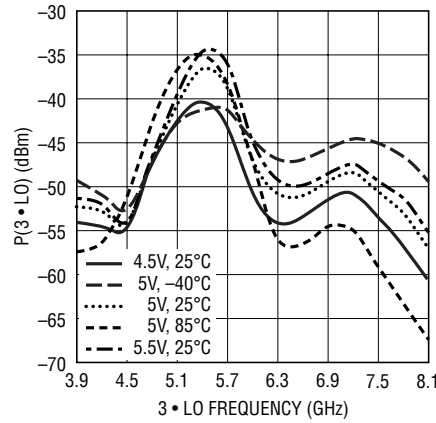

5528 G08

**LO to RF Output Feed-Through vs LO Frequency**

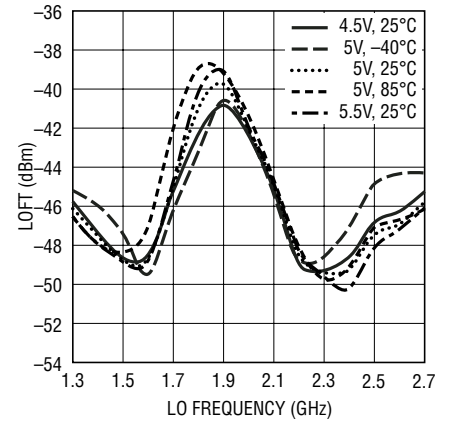

5528 G09

**Image Rejection vs LO Frequency**

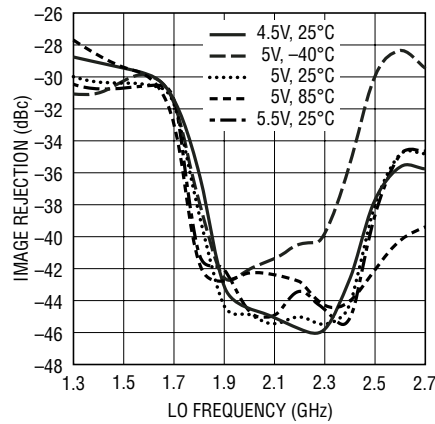

5528 G10

**Absolute I/Q Gain Imbalance vs LO Frequency**

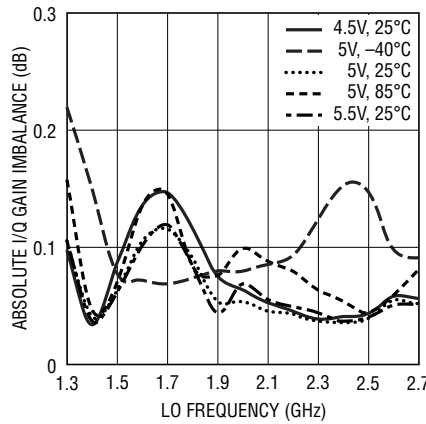

5528 G11

**Absolute I/Q Phase Imbalance vs LO Frequency**

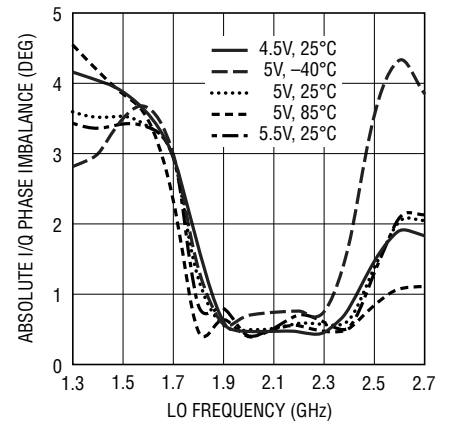

5528 G12

**TYPICAL PERFORMANCE CHARACTERISTICS**  $V_{CC} = 5V$ ,  $EN = High$ ,  $T_A = 25^\circ C$ ,  $f_{LO} = 2.14GHz$ ,  $P_{LO} = 0dBm$ . BBPI, BBMI, BBPQ, BBMQ inputs  $0.525V_{DC}$ , Baseband Input Frequency  $f_{BB} = 2MHz$ , I&Q  $90^\circ$  shifted.  $f_{RF} = f_{BB} + f_{LO}$  (upper sideband selection).  $P_{RF, OUT} = -10dBm$  ( $-10dBm/$ tone for 2-tone measurements), unless otherwise noted. (Note 3)

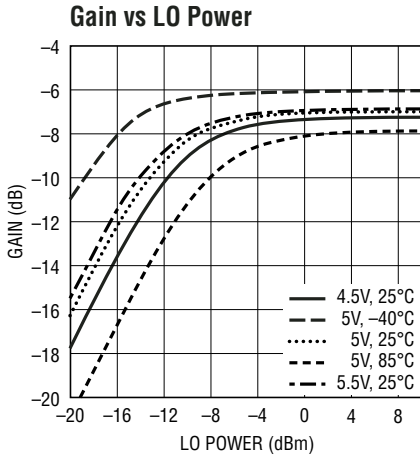

5528 G13

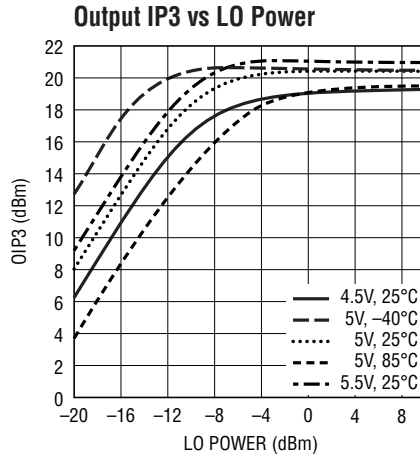

$f_{BB, 1} = 2MHz$   
 $f_{BB, 2} = 2.1MHz$

5528 G14

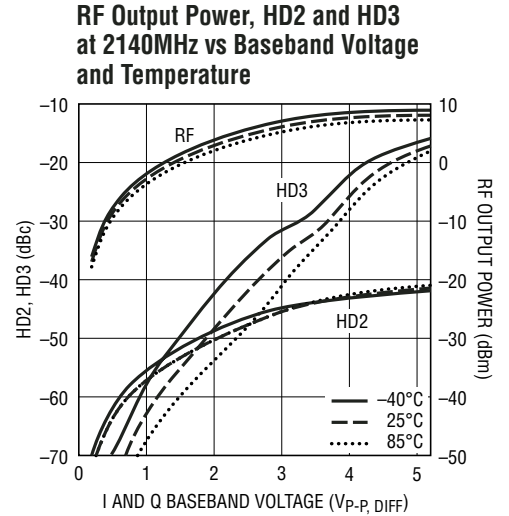

$f_{BB1} = 2MHz, 0^\circ$   
 $f_{BBQ} = 2MHz, 90^\circ$   
HD2 = MAX POWER AT  $f_{LO} + 2 \cdot f_{BB}$  OR  $f_{LO} - 2 \cdot f_{BB}$   
HD3 = MAX POWER AT  $f_{LO} + 3 \cdot f_{BB}$  OR  $f_{LO} - 3 \cdot f_{BB}$

5528 G15

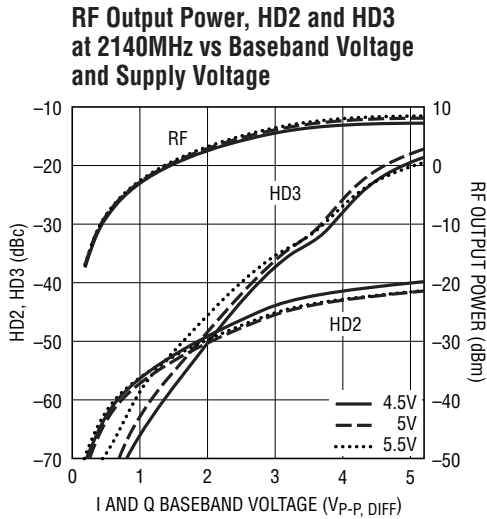

$f_{BB1} = 2MHz, 0^\circ$   
 $f_{BBQ} = 2MHz, 90^\circ$   
HD2 = MAX POWER AT  $f_{LO} + 2 \cdot f_{BB}$  OR  $f_{LO} - 2 \cdot f_{BB}$   
HD3 = MAX POWER AT  $f_{LO} + 3 \cdot f_{BB}$  OR  $f_{LO} - 3 \cdot f_{BB}$

5528 G16

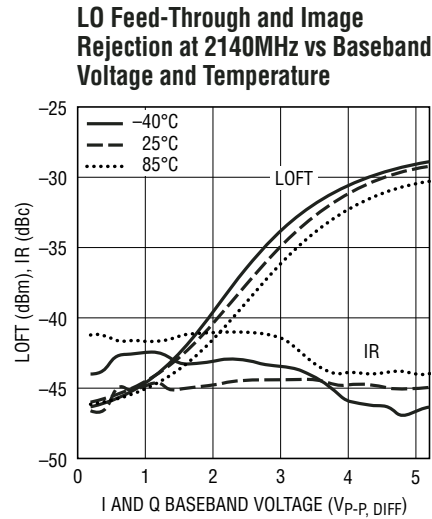

$f_{BB1} = 2MHz, 0^\circ$   
 $f_{BBQ} = 2MHz, 90^\circ$

5528 G17

**TYPICAL PERFORMANCE CHARACTERISTICS**  $V_{CC} = 5V$ ,  $EN = High$ ,  $T_A = 25^\circ C$ ,  $f_{LO} = 2.14GHz$ ,  $P_{LO} = 0dBm$ .  $BBPI$ ,  $BBMI$ ,  $BBPQ$ ,  $BBMQ$  inputs  $0.525V_{DC}$ , Baseband Input Frequency  $f_{BB} = 2MHz$ , I&Q  $90^\circ$  shifted.  $f_{RF} = f_{BB} + f_{LO}$  (upper sideband selection).  $P_{RF, OUT} = -10dBm$  ( $-10dBm/$ tone for 2-tone measurements), unless otherwise noted. (Note 3)

**LO Feed-Through and Image Rejection at 2140MHz vs Baseband Voltage and Supply Voltage**

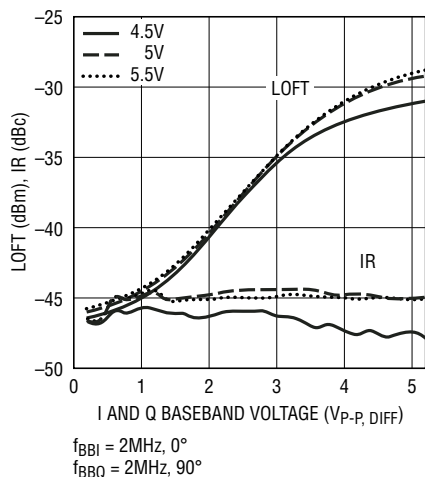

**LO and RF Port Return Loss vs RF Frequency**

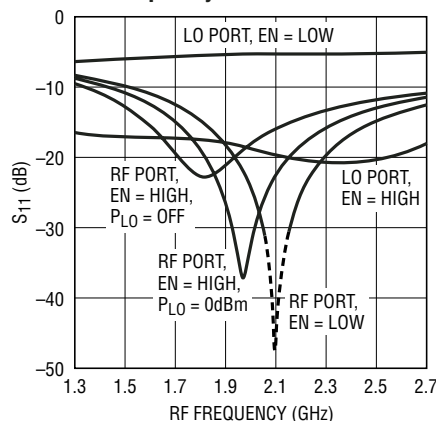

**RF Output Power vs RF Frequency at 1Vp-p Differential Baseband Drive**

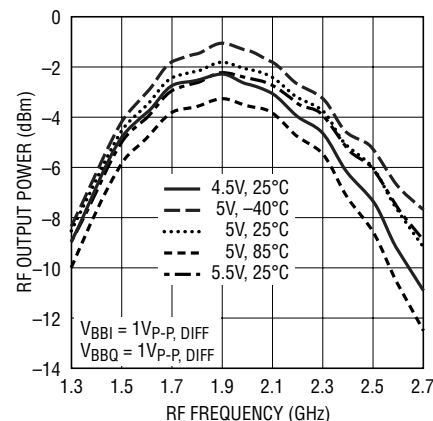

**PIN FUNCTIONS**

**EN (Pin 1):** Enable Input. When the EN pin voltage is higher than 1V, the IC is turned on. When the input voltage is less than 0.5V, the IC is turned off.

**GND (Pins 2, 4, 6, 9, 10, 12, 15):** Ground. Pins 6, 9, 15 and 17 (exposed pad) are connected to each other internally. Pins 2 and 4 are connected to each other internally and function as the ground return for the LO signal. Pins 10 and 12 are connected to each other internally and function as the ground return for the on-chip RF balun. For best RF performance, pins 2, 4, 6, 9, 10, 12, 15 and the Exposed Pad 17 should be connected to the printed circuit board ground plane.

**LO (Pin 3):** LO Input. The LO input is an AC-coupled single-ended input with approximately  $50\Omega$  input impedance at RF frequencies. Externally applied DC voltage should be within the range  $-0.5V$  to  $V_{CC} + 0.5V$  in order to avoid turning on ESD protection diodes.

**BBPQ, BBMQ (Pins 7, 5):** Baseband Inputs for the Q-channel, each  $45\Omega$  input impedance. Internally biased at about 0.525V. Applied voltage must stay below 2.5V.

**VCC (Pins 8, 13):** Power Supply. Pins 8 and 13 are connected to each other internally. It is recommended to use  $0.1\mu F$  capacitors for decoupling to ground on each of these pins.

**RF (Pin 11):** RF Output. The RF output is an AC-coupled single-ended output with approximately  $50\Omega$  output impedance at RF frequencies. Externally applied DC voltage should be within the range  $-0.5V$  to  $V_{CC} + 0.5V$  in order to avoid turning on ESD protection diodes.

**BBPI, BBMI (Pins 14, 16):** Baseband Inputs for the I-channel, each with  $45\Omega$  input impedance. These pins are internally biased at about 0.525V. Applied voltage must stay below 2.5V.

**Exposed Pad (Pin 17):** Ground. This pin must be soldered to the printed circuit board ground plane.



## BLOCK DIAGRAM

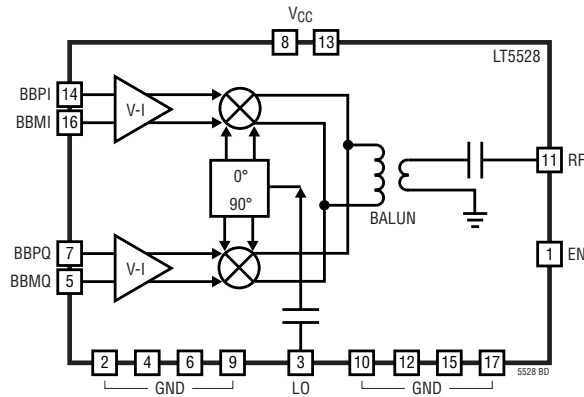

## APPLICATIONS INFORMATION

The LT5528 consists of I and Q input differential voltage-to-current converters, I and Q up-conversion mixers, an RF output balun, an LO quadrature phase generator and LO buffers.

External I and Q baseband signals are applied to the differential baseband input pins, BBPI, BBMI, and BBPQ, BBMQ. These voltage signals are converted to currents and translated to RF frequency by means of double-balanced up-converting mixers. The mixer outputs are combined in an RF output balun, which also transforms the output impedance to 50Ω. The center frequency of the resulting RF signal is equal to the LO signal frequency. The LO input drives a phase shifter which splits the LO signal into in-phase and quadrature LO signals. These LO signals are then applied to on-chip buffers which drive the up-conversion mixers. Both the LO input and RF output are single-ended, 50Ω-matched and AC coupled.

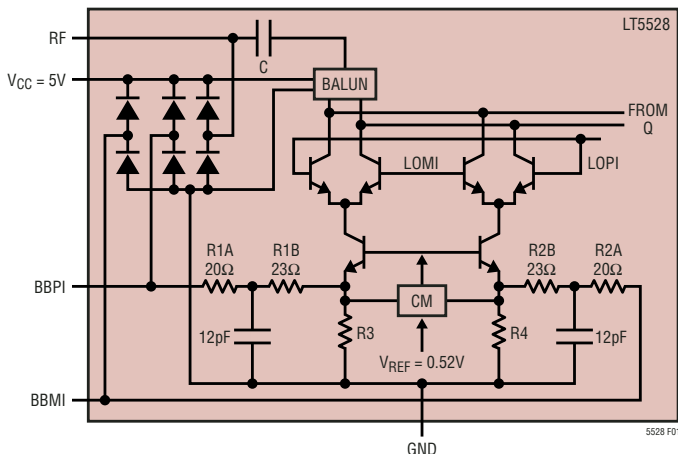

**Figure 1. Simplified Circuit Schematic of the LT5528 (Only I-Half is Drawn)**

### Baseband Interface

The baseband inputs (BBPI, BBMI), (BBPQ, BBMQ) present a differential input impedance of about 90Ω. At each of the four baseband inputs, a first-order low-pass filter using 20Ω



## APPLICATIONS INFORMATION

and 12pF to ground is incorporated (see Figure 1), which limits the baseband bandwidth to approximately 330MHz (−1dB point). The common-mode voltage is about 0.52V and is approximately constant over temperature.

It is important that the applied common-mode voltage level of the I and Q inputs is about 0.52V in order to properly bias the LT5528. Some I/Q test generators allow setting the common-mode voltage independently. In this case, the common-mode voltage of those generators must be set to 0.26V to match the LT5528 internal bias, because for DC signals, there is no −6dB source-load voltage division (see Figure 2).

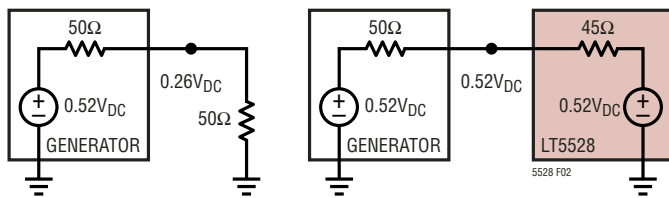

**Figure 2. DC Voltage Levels for a Generator Programmed at 0.26V<sub>DC</sub> for a 50Ω Load and the LT5528 as a Load**

It is recommended that the part be driven differentially; otherwise, the even-order distortion products will degrade the overall linearity severely. Typically, a DAC will be the signal source for the LT5528. To prevent aliasing, a filter should be placed between the DAC output and the LT5528’s baseband inputs. In Figure 3, an example interface schematic shows a commonly used DAC output interface followed by a passive 5<sup>th</sup> order ladder filter. The DAC in this example sources a current from 0mA to 20mA. The interface may be DC coupled. This allows adjustment of the DAC’s differential output current to minimize the LO feed-through. Optionally, transformer T1 can be inserted to improve the current balance in the BBPI and BBMI pins. This will improve the second-order distortion performance (OIP2).

The maximum single sideband CW RF output power at 2GHz using 20mA drive to both I and Q channels with the configuration shown in Figure 3 is about −2.5dBm. The maximum CW output power can be increased by connecting resistors R5 and R6 to −5V instead of GND, and changing their values to 550Ω. In that case, the maximum single sideband CW RF output power at 2GHz will be about 2.3dBm. In addition, the ladder filter component values require adjustment for a higher source impedance.

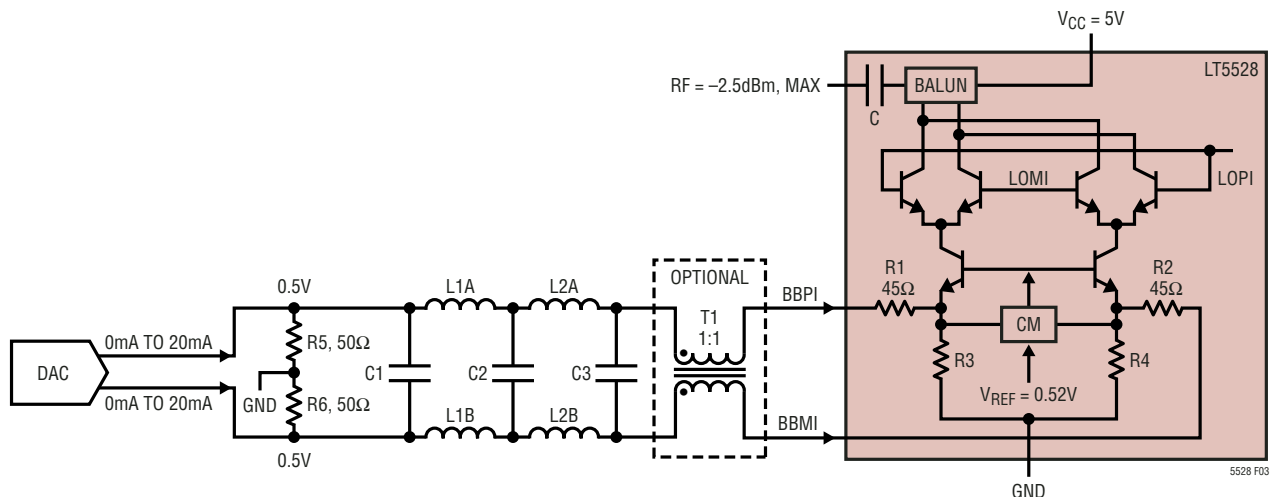

**Figure 3. LT5528 5<sup>th</sup> Order Filtered Baseband Interface with Common DAC (Only I-Channel is Shown)**

## APPLICATIONS INFORMATION

### LO Section

The internal LO input amplifier performs single-ended to differential conversion of the LO input signal. Figure 4 shows the equivalent circuit schematic of the LO input.

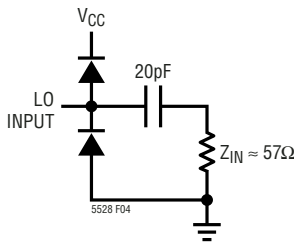

Figure 4. Equivalent Circuit Schematic of the LO Input

The internal, differential LO signal is then split into in-phase and quadrature (90° phase shifted) signals that drive LO buffer sections. These buffers drive the double balanced I and Q mixers. The phase relationship between the LO input and the internal in-phase LO and quadrature LO signals is fixed, and is independent of start-up conditions. The phase shifters are designed to deliver accurate quadrature signals for an LO frequency near 2GHz. For frequencies significantly below 1.8GHz or above 2.4GHz, the quadrature accuracy will diminish, causing the image rejection to degrade. The LO pin input impedance is about 50Ω, and the recommended LO input power is 0dBm. For lower LO input power, the gain, OIP2, OIP3 and dynamic-range will degrade, especially below -5dBm and at T<sub>A</sub> = 85°C. For high LO input power (e.g. 5dBm), the LO feed-through will increase with no improvement in linearity or gain. Harmonics present on the LO signal can degrade the image rejection because they can introduce a small excess phase shift in the internal phase splitter. For the second (at 4GHz) and third harmonics (at 6GHz) at -20dBc level, the introduced signal at the image frequency is about -56dBc or lower, corresponding to an excess phase shift much below 1 degree. For the second and third harmonics at -10dBc, the introduced signal at the image frequency is about -47dBc. Higher harmonics than the third will have less impact. The LO return loss typically will be better than 17dB over the 1.7GHz to 2.3GHz range. Table 1 shows the LO port input impedance vs. frequency.

Table 1. LO Port Input Impedance vs Frequency for EN = High

Frequency MHz	Input Impedance Ω	S <sub>11</sub>	
		Mag	Angle
1000	49.9 + j18.5	0.182	80
1400	68.1 + j8.8	0.171	22
1600	71.0 + j2.0	0.175	4.8
1800	70.0 - j8.6	0.182	-6.6
2000	62.0 - j12.8	0.156	-40
2200	53.8 - j13.6	0.135	-66
2400	47.3 - j12.4	0.128	-95
2600	41.1 - j12.0	0.161	-119

If the part is in shut-down mode, the input impedance of the LO port will be different. The LO input impedance for EN = Low is given in Table 2.

Table 2. LO Port Input Impedance vs Frequency for EN = Low

Frequency MHz	Input Impedance Ω	S <sub>11</sub>	
		Mag	Angle
1000	46.6 + j47.6	0.443	67.8
1400	136 + j44.5	0.507	13.8
1600	157 - j24.5	0.526	-6.2
1800	114 - j70.6	0.533	-24.6
2000	70.7 - j72.1	0.533	-43.2
2200	45.3 - j59.0	0.528	-62.8
2400	31.2 - j45.2	0.527	-83.5
2600	22.8 - j34.2	0.543	-103

### RF Section

After up-conversion, the RF outputs of the I and Q mixers are combined. An on-chip balun performs internal differential to single-ended output conversion, while transforming the output signal impedance to 50Ω. Table 3 shows the RF port output impedance vs. frequency.

Table 3. RF Port Output Impedance vs Frequency for EN = High and P<sub>LO</sub> = 0dBm

Frequency MHz	Output Impedance Ω	S <sub>22</sub>	
		Mag	Angle
1000	23.1 + j7.9	0.382	158
1400	34.4 + j20.7	0.298	113
1600	45.8 + j22.3	0.231	87.6
1800	54.5 + j12.4	0.125	63.2
2000	48.7 + j1.7	0.022	127
2200	39.1 + j1.0	0.123	174
2400	32.9 + j4.4	0.213	163
2600	29.7 + j7.4	0.269	155

## APPLICATIONS INFORMATION

The RF output  $S_{22}$  with no LO power applied is given in Table 4.

**Table 4. RF Port Output Impedance vs Frequency for EN = High and No LO Power Applied**

Frequency MHz	Output Impedance $\Omega$	$S_{22}$	
		Mag	Angle
1000	23.7 + j8.1	0.371	157
1400	37.7 + j18.5	0.248	112
1600	47.0 + j14.3	0.149	93.6
1800	46.0 + j5.5	0.071	123
2000	39.2 + j3.7	0.127	159
2200	34.2 + j6.2	0.201	154
2400	31.0 + j9.4	0.260	147
2600	29.6 + j11.6	0.292	142

For EN = Low the  $S_{22}$  is given in Table 5.

**Table 5. RF Port Output Impedance vs Frequency for EN = Low**

Frequency MHz	Output Impedance $\Omega$	$S_{22}$	
		Mag	Angle
1000	22.8 + j7.7	0.386	158
1400	32.4 + j20.8	0.321	116
1600	42.4 + j25.1	0.274	91.7
1800	54.6 + j20.1	0.193	66.2
2000	55.3 + j6.0	0.076	45.3
2200	44.7 + j0.0	0.056	180
2400	36.0 + j1.9	0.164	171
2600	31.3 + j4.8	0.237	162

To improve  $S_{22}$  for lower frequencies, a shunt capacitor can be added to the output. At higher frequencies, a shunt inductor can improve the  $S_{22}$ . Figure 5 shows the equivalent circuit schematic of the RF output.

Note that an ESD diode is connected internally from the RF output to ground. For strong output RF signal levels (higher than 3dBm), this ESD diode can degrade the linearity performance if the 50 $\Omega$  termination impedance is connected directly to ground. To prevent this,

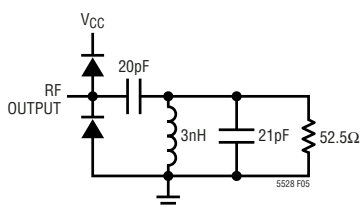
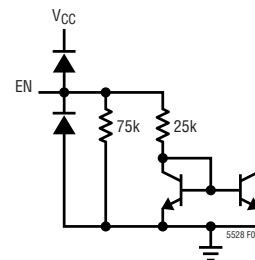

**Figure 5. Equivalent Circuit Schematic of the RF Output**

coupling capacitor can be inserted in the RF output line. This is strongly recommended during a 1 dB compression measurement.

### Enable Interface

Figure 6 shows a simplified schematic of the EN pin interface. The voltage necessary to turn on the LT5528 is 1V. To disable (shut down) the chip, the Enable voltage must be below 0.5V. If the EN pin is not connected, the chip is disabled. This EN = Low condition is guaranteed by the 75k on-chip pull-down resistor. It is important that the voltage at the EN pin does not exceed  $V_{CC}$  by more than 0.5V. If this should occur, the supply current could be sourced through the EN pin ESD protection diodes, which are not designed to carry the full supply current, and damage may result.



**Figure 6. EN Pin Interface**

### Evaluation Board

Figure 7 shows the evaluation board schematic. A good ground connection is required for the exposed pad. If this is not done properly, the RF performance will degrade.

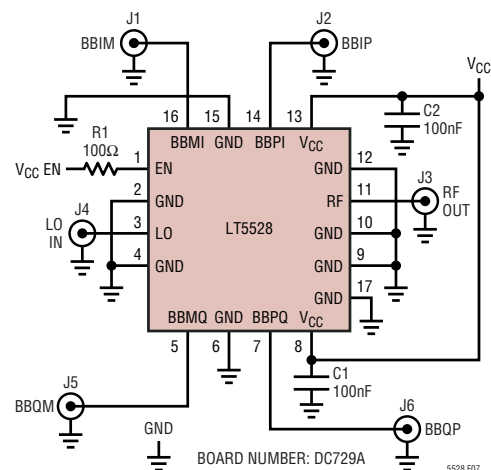

**Figure 7. Evaluation Circuit Schematic**

## APPLICATIONS INFORMATION

Additionally, the exposed pad provides heat sinking for the part and minimizes the possibility of the chip overheating. If improved LO and Image suppression are required, an LO feed-through calibration and an Image suppression calibration can be performed. The evaluation board schematic of the calibration hardware, the calibration procedure and

the results are described in an application note.

R1 (optional) limits the Enable pin current in the event that the Enable pin is pulled high while the  $V_{CC}$  inputs are low. In Figures 8, 9, 10 and 11, the silk screens and the PCB board layout are shown.

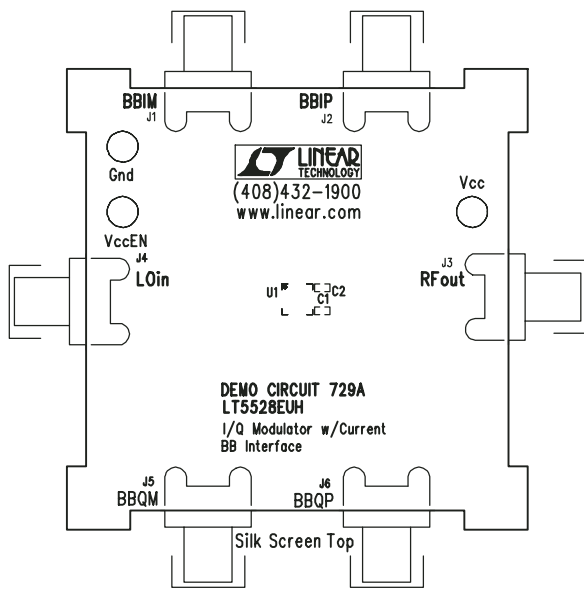

Figure 8. Component Side Silk Screen of Evaluation Board

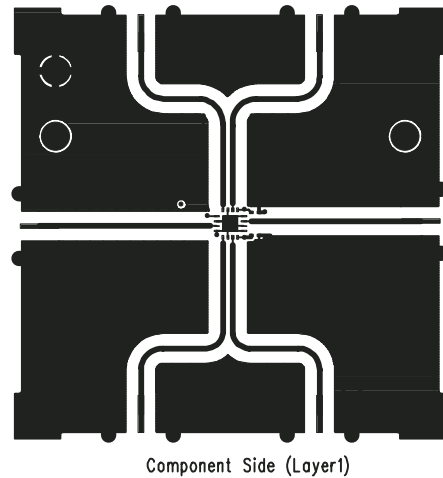

Figure 9. Component Side Layout of Evaluation Board

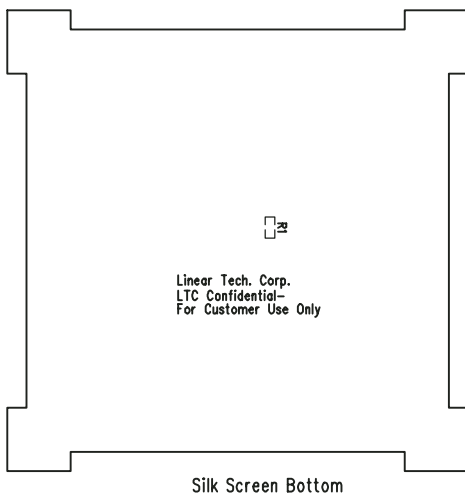

Figure 10. Bottom Side Silk Screen of Evaluation Board

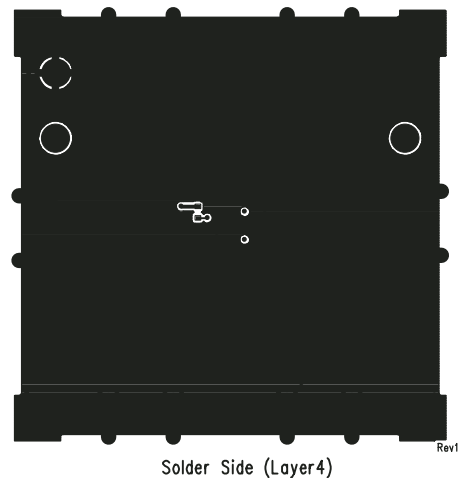

Figure 11. Bottom Side Layout of Evaluation Board

# APPLICATIONS INFORMATION

## Application Measurements

The LT5528 is recommended for base-station applications using various modulation formats. Figure 12 shows a typical application. The CAL box in Figure 12 allows for LO feed-through and Image suppression calibration.

Figure 13 shows the ACPR performance for W-CDMA using one, two or four channel modulation. Figures 14, 15 and 16 illustrate the 1-, 2- and 4-channel W-CDMA measurement. To calculate ACPR, a correction is made for the spectrum analyzer noise floor. If the output power is high, the ACPR will be limited by the linearity performance of the part. If the output power is low, the ACPR will be limited by the noise performance of the part. In the middle, an optimum ACPR is obtained.

Because of the LT5528's very high dynamic-range, the test equipment can limit the accuracy of the ACPR measurement. Consult the factory for advice on the ACPR measurement, if needed.

The ACPR performance is sensitive to the amplitude match of the BBIP and BBIM (or BBQP and BBQM) inputs. This is because a difference in AC current amplitude will give rise to a difference in amplitude between the even-order harmonic products generated in the internal V-I converter. As a result, they will not cancel out entirely. Therefore, it is important to keep the currents in those pins exactly the same (but of opposite sign). The current will enter the LT5528's common-base stage, and will flow to the mixer upper switches. This can be seen in Figure 1 where the

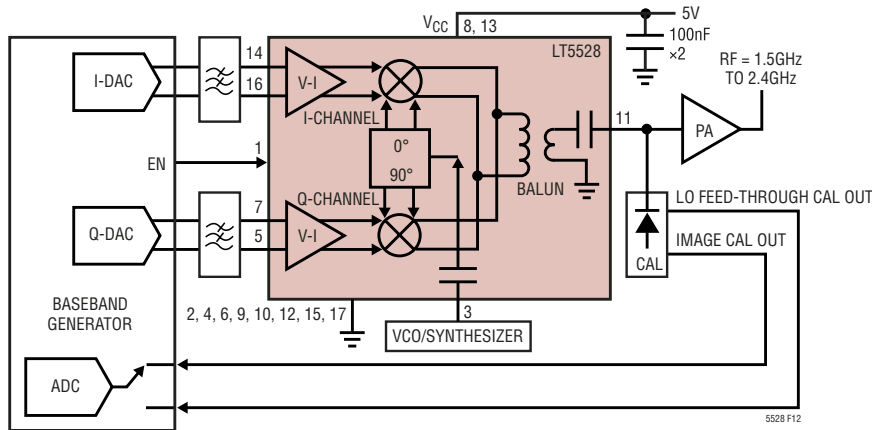

Figure 12. 1.5GHz to 2.4GHz Direct Conversion Transmitter Application with LO Feed-Through and Image Calibration Loop

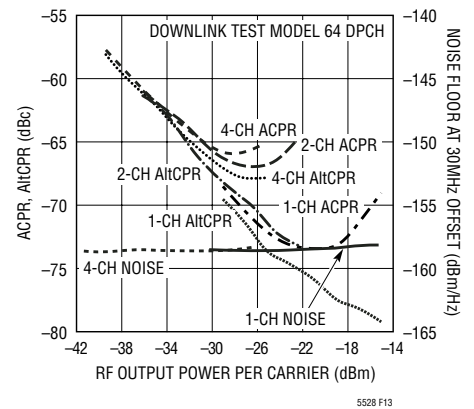

Figure 13: W-CDMA APCR, AItCPR and Noise vs RF Output Power at 2140MHz for 1, 2 and 4 Channels

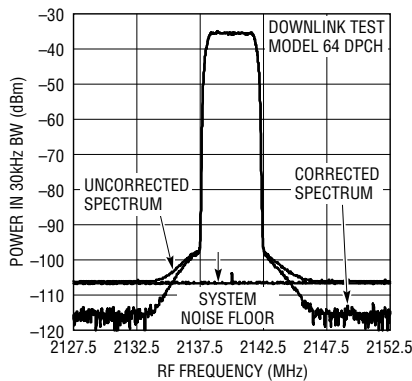

Figure 14: 1-Channel W-CDMA Spectrum

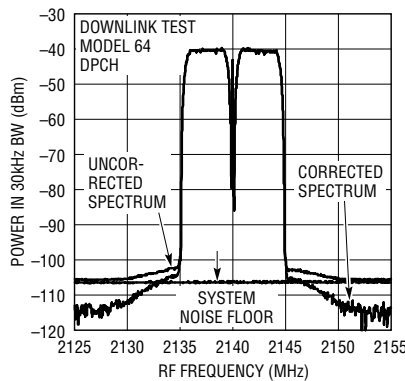

Figure 15: 2-Channel W-CDMA Spectrum

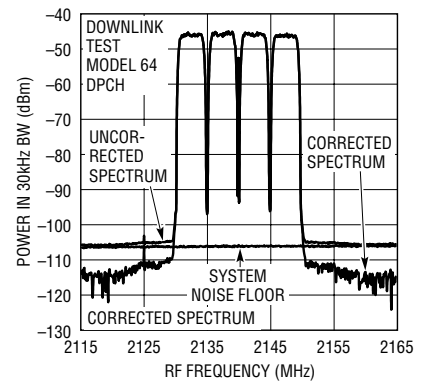

Figure 16: 4-Channel W-CDMA Spectrum

## APPLICATIONS INFORMATION

internal circuit of the LT5528 is drawn. For best results, a high ohmic source is recommended; for example, the interface circuit drawn in Figure 3, modified by pulling resistors R5 and R6 to a -5V supply and adjusting their values to 550Ω, with T1 omitted.

Another method to reduce current mismatch between the currents flowing in the BBIP and BBIM pins (or the BBQP and BBQM pins) is to use a 1:1 transformer with the two windings in the DC path (T1 in Figure 3). For DC, the transformer forms a short, and for AC, the transformer will reduce the common-mode current component, which forces the two currents to be better matched. Alternatively, a transformer with 1:2 impedance ratio can be used, which gives a convenient DC separation between primary and

secondary in combination with the required impedance match. The secondary center tap should not be connected, which allows some voltage swing if there is a single-ended input impedance difference at the baseband pins. As a result, both currents will be equal. The disadvantage is that there is no DC coupling, so the LO feed-through calibration cannot be performed via the BB connections. After calibration when the temperature changes, the LO feed-through and the Image Rejection performance will change. This is illustrated in Figure 17. The LO feed-through and Image Rejection can also change as a function of the baseband drive level, as is depicted in Figure 18. The RF output power, IM2 and IM3 vs a two-tone baseband drive are given in Figure 19.

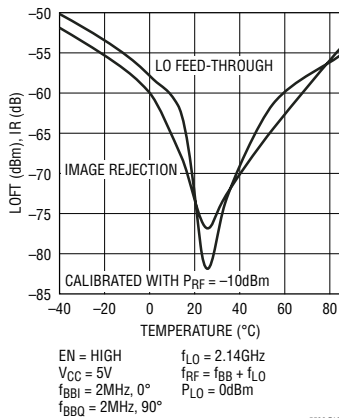

Figure 17: LO Feed-Through and Image Rejection vs Temperature after Calibration at 25°C

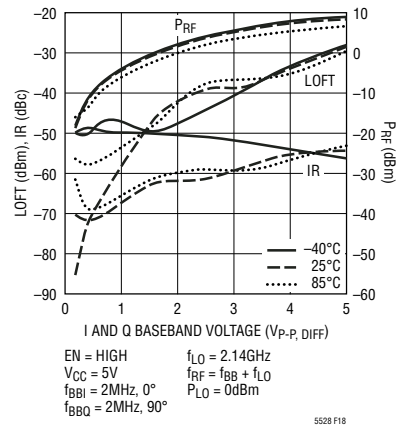

Figure 18: LO Feed-Through and Image Rejection vs Baseband Drive Voltage after Calibration at 25°C

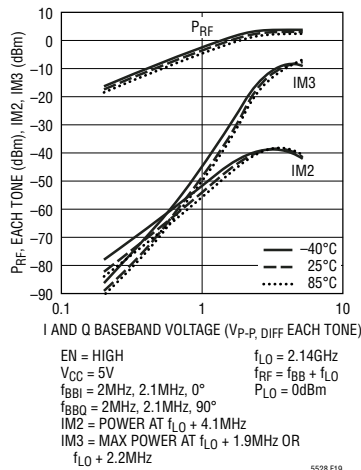
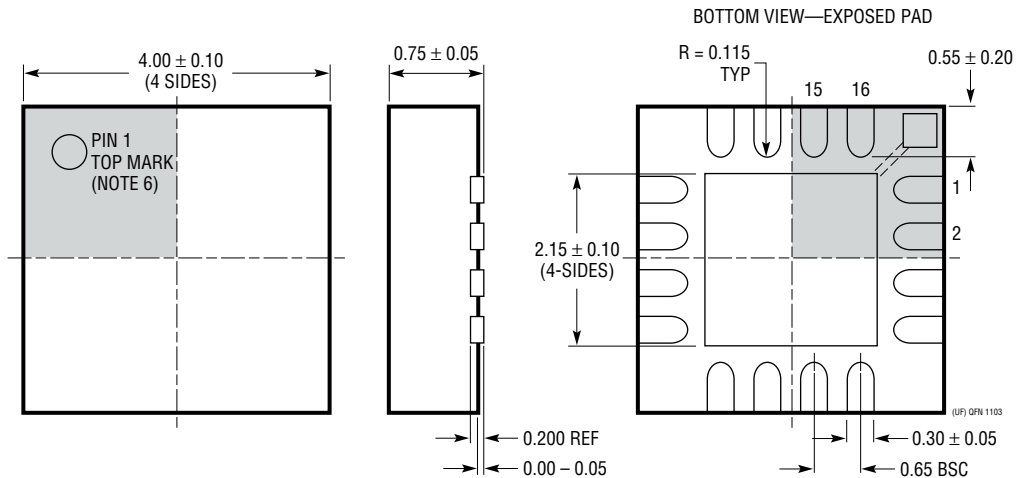
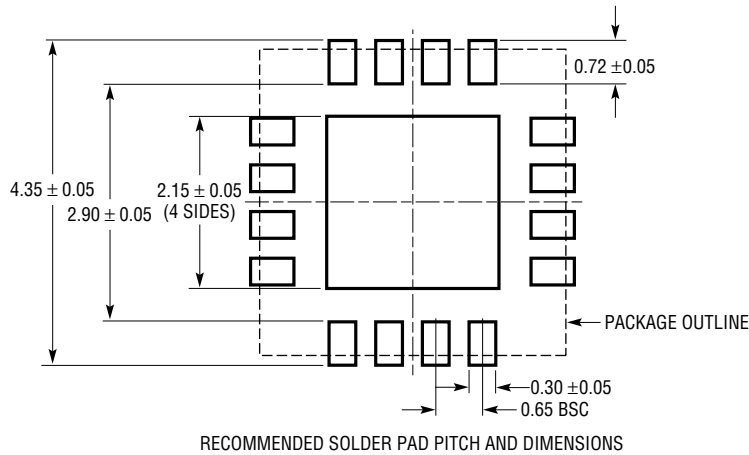

Figure 19: RF Two-Tone Power, IM2 and IM3 at 2140MHz vs Baseband Voltage

**PACKAGE DESCRIPTION**

**UF Package**  
**16-Lead Plastic QFN (4mm × 4mm)**  
 (Reference LTC DWG # 05-08-1692)



- NOTE:
1. DRAWING CONFORMS TO JEDEC PACKAGE OUTLINE MO-220 VARIATION (WGCC)
  2. DRAWING NOT TO SCALE
  3. ALL DIMENSIONS ARE IN MILLIMETERS
  4. DIMENSIONS OF EXPOSED PAD ON BOTTOM OF PACKAGE DO NOT INCLUDE MOLD FLASH. MOLD FLASH, IF PRESENT, SHALL NOT EXCEED 0.15mm ON ANY SIDE
  5. EXPOSED PAD SHALL BE SOLDER PLATED
  6. SHADED AREA IS ONLY A REFERENCE FOR PIN 1 LOCATION ON THE TOP AND BOTTOM OF PACKAGE



## RELATED PARTS

PART NUMBER	DESCRIPTION	COMMENTS
<b>Infrastructure</b>		
LT5511	High Linearity Upconverting Mixer	RF Output to 3GHz, 17dBm IIP3, Integrated LO Buffer
LT5512	DC-3GHz High Signal Level Downconverting Mixer	DC to 3GHz, 17dBm IIP3, Integrated LO Buffer
LT5514	Ultralow Distortion, IF Amplifier/ADC Driver with Digitally Controlled Gain	850MHz Bandwidth, 47dBm OIP3 at 100MHz, 10.5dB to 33dB Gain Control Range
LT5515	1.5GHz to 2.5GHz Direct Conversion Quadrature Demodulator	20dBm IIP3, Integrated LO Quadrature Generator
LT5516	0.8GHz to 1.5GHz Direct Conversion Quadrature Demodulator	21.5dBm IIP3, Integrated LO Quadrature Generator
LT5517	40MHz to 900MHz Quadrature Demodulator	21dBm IIP3, Integrated LO Quadrature Generator
LT5519	0.7GHz to 1.4GHz High Linearity Upconverting Mixer	17.1dBm IIP3 at 1GHz, Integrated RF Output Transformer with 50Ω Matching, Single-Ended LO and RF Ports Operation
LT5520	1.3GHz to 2.3GHz High Linearity Upconverting Mixer	15.9dBm IIP3 at 1.9GHz, Integrated RF Output Transformer with 50Ω Matching, Single-Ended LO and RF Ports Operation
LT5521	10MHz to 3700MHz High Linearity Upconverting Mixer	24.2dBm IIP3 at 1.95GHz, NF = 12.5dB, 3.15V to 5.25V Supply, Single-Ended LO Port Operation
LT5522	600MHz to 2.7GHz High Signal Level Downconverting Mixer	4.5V to 5.25V Supply, 25dBm IIP3 at 900MHz, NF = 12.5dB, 50Ω Single-Ended RF and LO Ports
LT5524	Low Power, Low Distortion ADC Driver with Digitally Programmable Gain	450MHz Bandwidth, 40dBm OIP3, 4.5dB to 27dB Gain Control
LT5526	High Linearity, Low Power Downconverting Mixer	3V to 5.3V Supply, 16.5dBm IIP3, 100kHz to 2GHz RF, NF = 11dB, I <sub>S</sub> = 28mA, -65dBm LO-RF Leakage
<b>RF Power Detectors</b>		
LT5504	800MHz to 2.7GHz RF Measuring Receiver	80dB Dynamic Range, Temperature Compensated, 2.7V to 5.25V Supply
LTC5505	RF Power Detectors with >40dB Dynamic Range	300MHz to 3GHz, Temperature Compensated, 2.7V to 6V Supply
LTC5507	100kHz to 1000MHz RF Power Detector	100kHz to 1GHz, Temperature Compensated, 2.7V to 6V Supply
LTC5508	300MHz to 7GHz RF Power Detector	44dB Dynamic Range, Temperature Compensated, SC70 Package
LTC5509	300MHz to 3GHz RF Power Detector	36dB Dynamic Range, Low Power Consumption, SC70 Package
LTC5530	300MHz to 7GHz Precision RF Power Detector	Precision V <sub>OUT</sub> Offset Control, Shutdown, Adjustable Gain
LTC5531	300MHz to 7GHz Precision RF Power Detector	Precision V <sub>OUT</sub> Offset Control, Shutdown, Adjustable Offset
LTC5532	300MHz to 7GHz Precision RF Power Detector	Precision V <sub>OUT</sub> Offset Control, Adjustable Gain and Offset
LT5534	50MHz to 3GHz RF Power Detector with 60dB Dynamic Range	±1dB Output Variation over Temperature, 38ns Response Time
<b>Low Voltage RF Building Blocks</b>		
LT5500	1.8GHz to 2.7GHz Receiver Front End	1.8V to 5.25V Supply, Dual-Gain LNA, Mixer, LO Buffer
LT5502	400MHz Quadrature IF Demodulator with RSSI	1.8V to 5.25V Supply, 70MHz to 400MHz IF, 84dB Limiting Gain, 90dB RSSI Range
LT5503	1.2GHz to 2.7GHz Direct IQ Modulator and Upconverting Mixer	1.8V to 5.25V Supply, Four-Step RF Power Control, 120MHz Modulation Bandwidth
LT5506	500MHz Quadrature Demodulator with VGA	1.8V to 5.25V Supply, 40MHz to 500MHz IF, -4dB to 57dB Linear Power Gain, 8.8MHz Baseband Bandwidth
LT5546	500MHz Quadrature Demodulator with VGA and 17MHz Baseband Bandwidth	17MHz Baseband Bandwidth, 40MHz to 500MHz IF, 1.8V to 5.25V Supply, -7dB to 56dB Linear Power Gain
<b>Wide Bandwidth ADCs</b>		
LTC1749	12-Bit, 80Msps	500MHz BW S/H, 71.8dB SNR
LTC1750	14-Bit, 80Msps	500MHz BW S/H, 75.5dB SNR