



LT1500/LT1501

Adaptive-Frequency Current Mode Switching Regulators

OBSOLETE:
FOR INFORMATION PURPOSES ONLY
Contact Linear Technology for Potential Replacement

FEATURES

- Low Noise Adaptive-Frequency Current Mode Operation Avoids Low Frequency Noise at Most Load Currents
- Can Be Externally Synchronized (LT1500)
- Micropower Quiescent Current: 200µA
- Shutdown Current: 8µA Typ
- Internal Loop Compensation
- Low-Battery Comparator Active in Shutdown
- Minimum Input Voltage: 1.8V Typ
- Additional Negative Voltage Feedback Pin (LT1500)
- Up to 500kHz Switching Frequency
- Uses Low Profile, Low Cost Surface Mount Inductors

APPLICATIONS

- Portable Instrumentation
- Battery Operated Systems
- PDA's
- Standby Power

DESCRIPTION

The LT[®]1500 is an adaptive-frequency current mode step-up switching regulator with an internal power switch that is rated up to 700mA. In contrast to pulse skipping switching regulators, the LT1500 uses a current mode topology that provides lower noise operation and improved efficiency. Only at very light loads is Burst Mode[™] activated to give high efficiency and micropower operation. High switching frequency (up to 500kHz) allows very small inductors to be used, along with ceramic capacitors if desired.

The LT1500 operates with input voltages from 1.8V to 15V and has only 200µA operating current dropping to 8µA in shutdown. A low-battery comparator is included which stays alive in shutdown. A second output feedback pin with negative polarity allows negative output voltages to be regulated when the switcher is connected up as a Cuk or a flyback converter.

Two package types are available. The LT1500 comes in a 14-pin SO package, with two options available for fixed output (3.3V or 5V) or adjustable operation. A reduced feature part, the LT1501, comes in the smaller 8-pin SO package with internal frequency compensation. It is also available in adjustable and fixed output voltage versions.

LT, LTC and LT are registered trademarks of Linear Technology Corporation. Burst Mode is a trademark of Linear Technology Corporation.

TYPICAL APPLICATION

2-Cell to 5V Converter

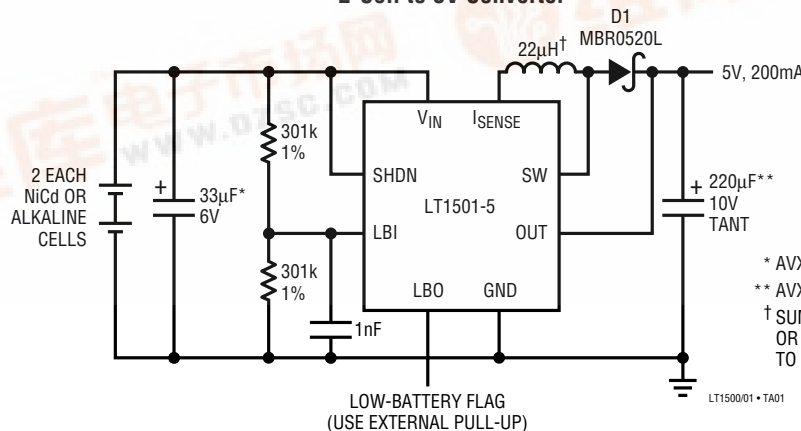

* AVX, TPSC107M006R0150
 ** AVX, TPSC107M010 R0100
 † SUMIDA CD73-220, CD54-220 OR CD43-220. SELECT ACCORDING TO MAXIMUM LOAD CURRENT



LT1500/LT1501

ABSOLUTE MAXIMUM RATINGS

Supply Voltage	20V	Operating Ambient Temperature Range	
Switch Voltage (SW)	30V	Commercial	0°C to 70°C
Shutdown Voltage (SHDN)	20V	Industrial	-40°C to 85°C
I _{SENSE} Voltage	20V	Operating Junction Temperature Range	
FB Voltage	5V	Commercial	0°C to 100°C
LBI Voltage	5V	Industrial	-40°C to 100°C
LBO Voltage	15V	Storage Temperature Range	-65°C to 150°C
		Lead Temperature (Soldering, 10 sec)	300°C

PACKAGE/ORDER INFORMATION

<p>S PACKAGE 14-LEAD PLASTIC SO T_{JMAX} = 100°C, θ_{JA} = 100°C/W</p>	<p>S PACKAGE 14-LEAD PLASTIC SO T_{JMAX} = 100°C, θ_{JA} = 100°C/W</p>	<p>S8 PACKAGE 8-LEAD PLASTIC SO T_{JMAX} = 100°C, θ_{JA} = 120°C/W</p>
ORDER PART NUMBER	ORDER PART NUMBER	ORDER PART NUMBER
LT1500CS LT1500IS	LT1500CS-3/5 LT1500IS-3/5	LT1501CS8 LT1501CS8-3.3 LT1501CS8-5 LT1501IS8 LT1501IS8-3.3 LT1501IS8-5

Consult factory for Military grade parts.

ELECTRICAL CHARACTERISTICS $T_J = 25^\circ\text{C}$, $V_{IN} = 2.3\text{V}$ unless otherwise noted.

PARAMETER	CONDITIONS	MIN	TYP	MAX	UNITS
Feedback/Output Pin Reference Voltage	LT1500/LT1501, $T_J = 25^\circ\text{C}$ All Conditions (Note 6)	1.240	1.265	1.290	V
		1.235		1.295	V
	LT1500-3/5, Select Pin Open All Conditions (Note 6)	3.230	3.300	3.370	V
		3.200		3.400	V
Reference Voltage Line Regulation	LT1500-3/5, Select Pin Grounded All Conditions (Note 6)	4.900	5.000	5.100	V
		4.85		5.15	V
Reference Voltage Line Regulation	$V_{IN} = 2.3\text{V}$ to 15V		0.02	0.06	%/V
Feedback Pin Bias Current			30	100	nA

ELECTRICAL CHARACTERISTICS $T_J = 25^\circ\text{C}$, $V_{IN} = 2.3\text{V}$ unless otherwise noted.

PARAMETER	CONDITIONS		MIN	TYP	MAX	UNITS
Internal Divider Current	LT1500-3.3/LT1501-3.3	●		22	30	μA
	LT1500-5/LT1501-5	●		33	45	μA
Operating Quiescent Current	$V_{IN} \leq 5\text{V}$, $V_{SHDN} = 2.3\text{V}$ (Note 1) $V_{IN} = 15\text{V}$	●		200	280	μA
		●			320	μA
Supply Current in Shutdown	$V_{SHDN} \leq 0.2\text{V}$, Fixed Voltages (Note 7) $T_J \geq 0^\circ\text{C}$ $T_J < 0^\circ\text{C}$	●		8	15	μA
					20	μA
Shutdown Pin Threshold		●	0.4		1.1	V
Shutdown Pin Input Current	$V_{SHDN} = 2.3\text{V}$	●		3	10	μA
Input Start-Up Voltage	$V_{SHDN} = V_{IN}$ $T_J \geq 0^\circ\text{C}$ $T_J < 0^\circ\text{C}$	●		2.0	2.1	V
					2.2	V
Undervoltage Lockout	Light Load Full Load			1.8		V
				2.0	2.1	V
Power Switch						
Switch On Resistance	$I_{SW} = 0.7\text{A}$ (Note 2)	●		0.50	0.72	Ω
Peak Switch Current (Note 3)		●	0.7	0.85	1.3	A
Switch Breakdown Voltage	$I_{SW} = 100\mu\text{A}$	●	30	45		V
Switch Leakage Current	$V_{SW} = 5\text{V}$ $V_{SW} = 20\text{V}$	●		0.2	5	μA
		●		0.3	10	μA
Switch Turn-On Delay (Note 5)				800		ns
Switch Turn-Off Delay (Note 5)				400		ns
Current Sense Resistor		●	0.28	0.42		Ω
Low-Battery Comparator						
Low-Battery Threshold	Falling Edge	●	1.20	1.24	1.28	V
Threshold Hysteresis				20		mV
LBI Input Bias Current		●		20	50	nA
LBO Output Low State	$V_{LBI} = 1.2\text{V}$, $I_{SINK} = 100\mu\text{A}$ $I_{SINK} = 2\text{mA}$	●		0.1	0.25	V
		●		0.3	0.5	V
LBO Leakage Current	$V_{LBI} = 1.3\text{V}$, $V_{LBO} \leq 15\text{V}$	●			2	μA
LT1500 Functions						
SYNC Pin Bias Current	$V_{SYNC} = 3.3\text{V}$	●		15	35	μA
SYNC Pin Threshold		●	0.4		1.3	V
Error Amplifier Transconductance				600		μmho
V_C Pin Source Current				20		μA
V_C Pin High Clamp Voltage			1.20	1.26	1.32	V
NFB Reference Voltage	FB Pin Open	●	1.230	1.265	1.300	V
NFB Pin Bias Current		●		12	20	μA
NFB to FB Transconductance	Note 4			10,000		μmho
Soft Start Bias Current	Current Flows Out of Pin	●	2	4	7	μA

LT1500/LT1501

ELECTRICAL CHARACTERISTICS

The ● denotes specifications which apply over the full operating temperature range.

Note 1: Feedback pin or output is held slightly above the regulated value to force the V_C node low and switching to stop.

Note 2: See Typical Performance Characteristics for graph of Guaranteed Switch Voltage vs Saturation Voltage.

Note 3: Peak switch current is the guaranteed minimum value of switch current available in normal operation. Highest calculated switch current at full load should not exceed the minimum value shown.

Note 4: Loading on FB pin will affect NFB reference voltage. $\Delta V_{NFB} = I_{FB}/g_m$. Do not exceed 10 μ A loading on FB when NFB is being used.

Note 5: This is the delay between sense pin current reaching its upper or lower threshold and switch transition. Switch delay times cause peak-to-

peak inductor current to increase and therefore switching frequency to be low. This effect will be significant for frequencies above 100kHz. See Application Information and Typical Performance Characteristics.

Note 6: Reference voltage under all conditions includes $V_{IN} = 2.1V$ to 15V, all loads and full temperature range.

Note 7: As with all boost regulators the output voltage of the LT1500 cannot fall to less than input voltage because of the path through the catch diode. This means that the output voltage divider on adjustable parts will still be generating feedback voltage at the FB pin (fixed voltage parts have an internal switch to disconnect the divider in shutdown). If the voltage on FB is greater than 0.6V in shutdown, the internal error amplifier will draw current that adds to shutdown current. See graph of Shutdown Current vs FB voltage in Typical Performance Characteristics.

TYPICAL PERFORMANCE CHARACTERISTICS

Switching Frequency (3.3V Output)

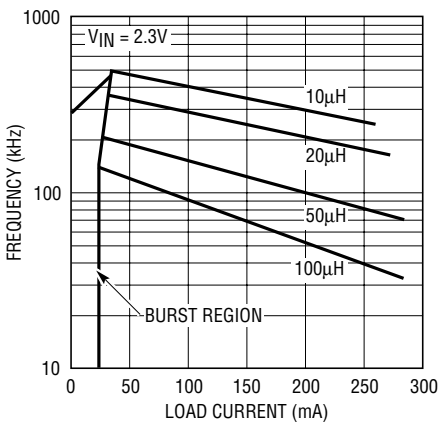

Switching Frequency (5V Output)

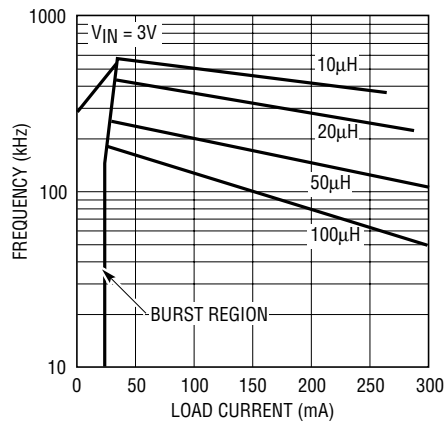

Switching Frequency (12V Output)

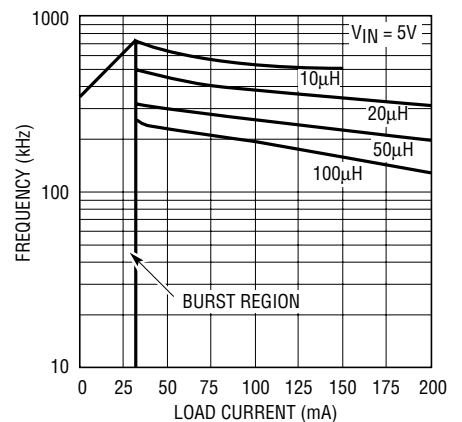

Efficiency (3.3V Output)

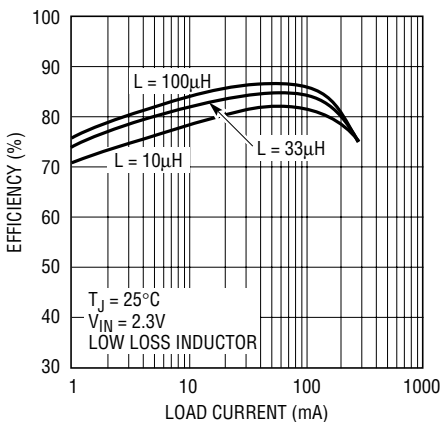

Efficiency (5V Output)

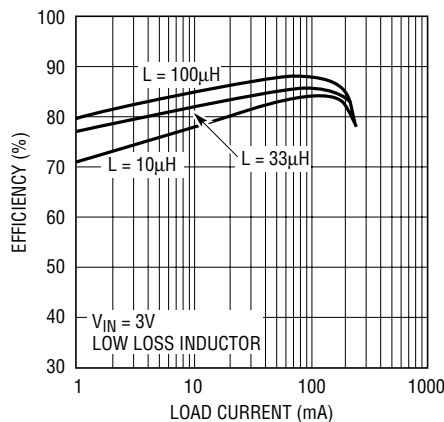

Efficiency (12V Output)

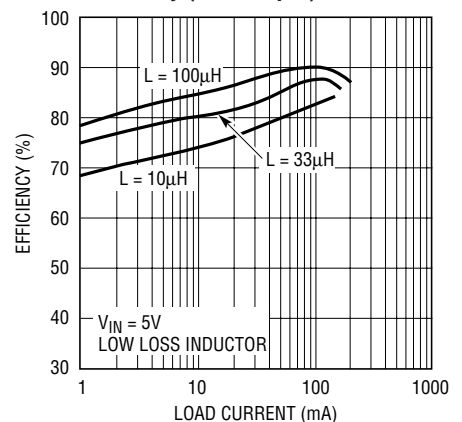

TYPICAL PERFORMANCE CHARACTERISTICS

Efficiency (3.3V Output)

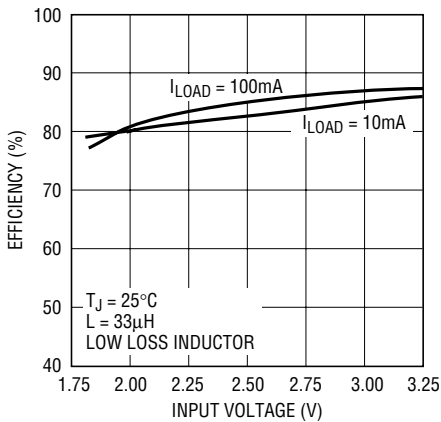

LT1500/01 • TPC11

Efficiency (5V Output)

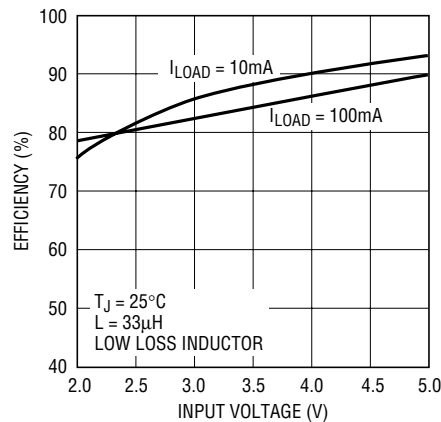

LT1500/01 • TPC12

Efficiency (12V Output)

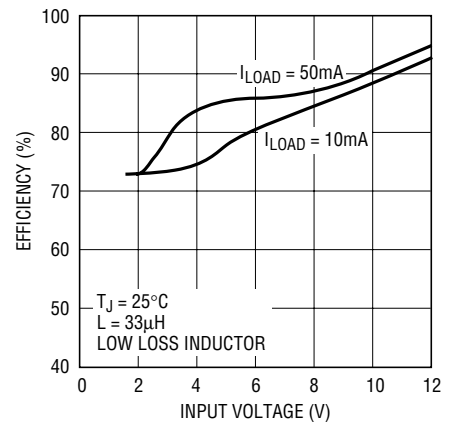

LT1500/01 • TPC13

Inductor Copper Loss (3.3V Output)

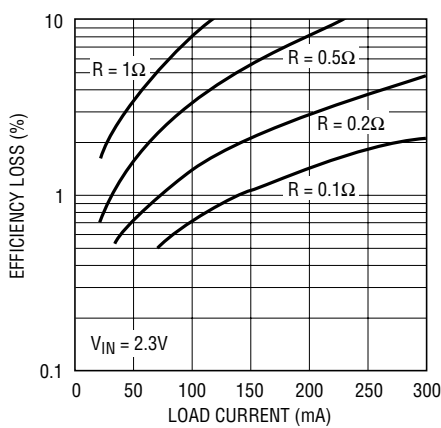

LT1500/01 • TPC14

Inductor Copper Loss (5V Output)

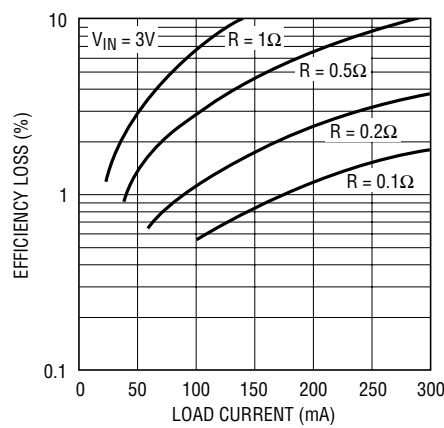

LT1500/01 • TPC15

Inductor Copper Loss (12V Output)

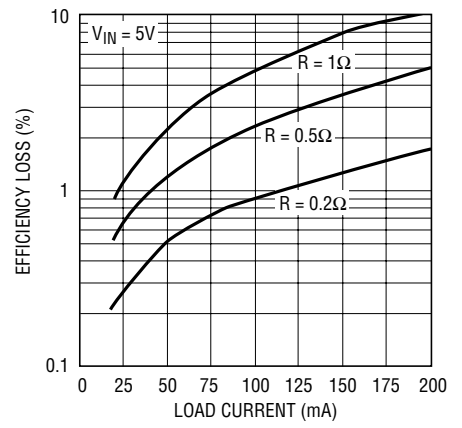

LTC1500/01 • TPC16

Maximum Load Current (3.3V Output)

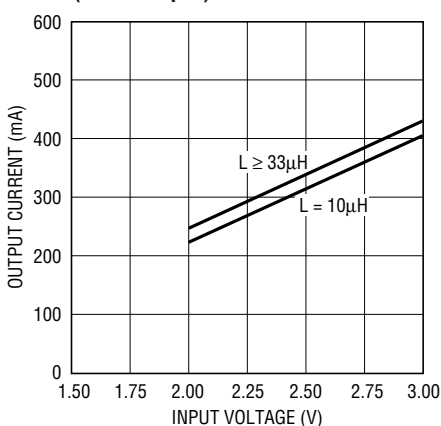

LT1500/01 • TPC08

Maximum Load Current (5V Output)

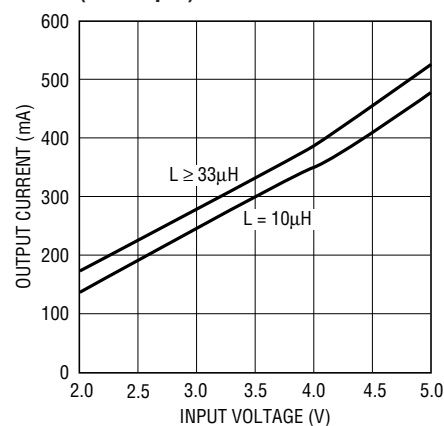

LT1500/01 • TPC09

Maximum Load Current (12V Output)

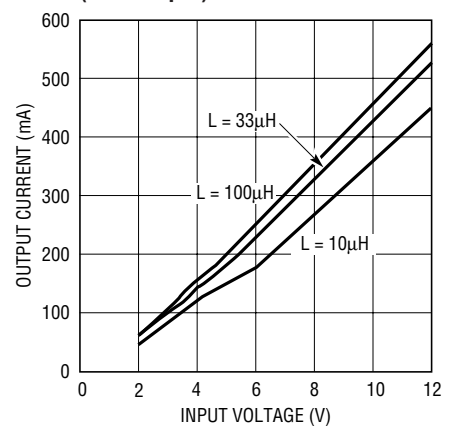

LT1500/01 • TPC10

TYPICAL PERFORMANCE CHARACTERISTICS

Burst Mode Threshold

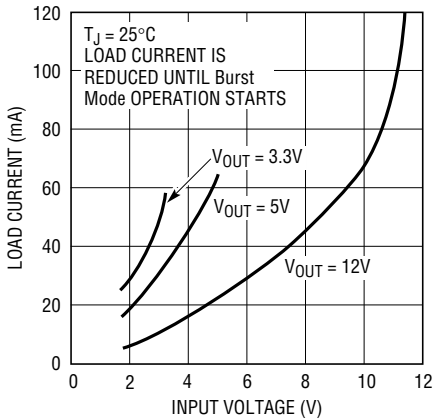

LT1500/01 • TPC01

Switch Saturation Voltage

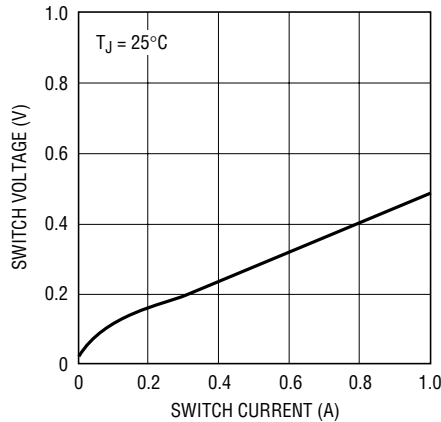

LT1500/01 • TPC06

Peak-to-Peak Inductor Ripple Current

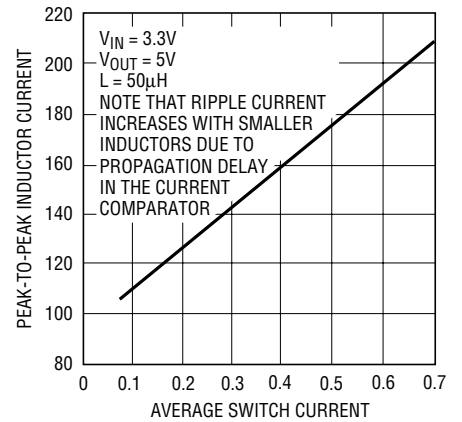

LT1500/01 • TPC07

Quiescent Input Supply Current

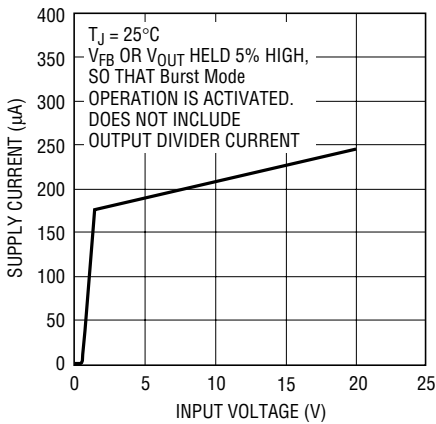

LT1500/01 • TPC04

Low-Battery Output Saturation Voltage

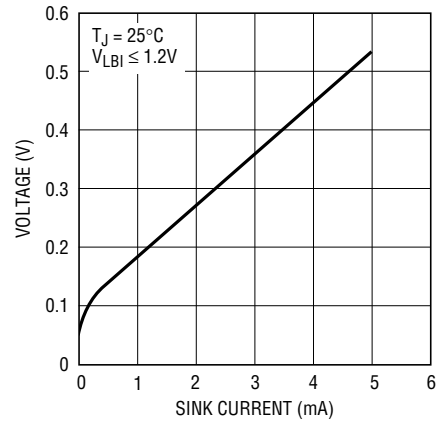

LT1500/01 • TPC02

Input Current in Shutdown

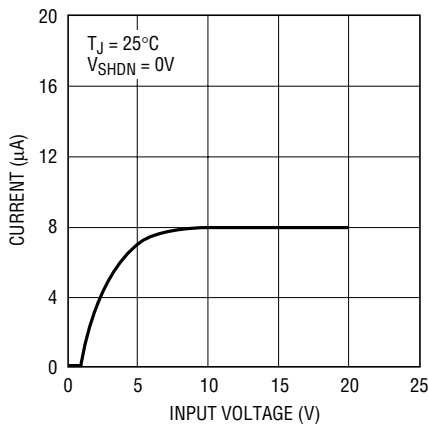

LT1500/01 • TPC03

Shutdown Input Current vs Feedback Pin Voltage

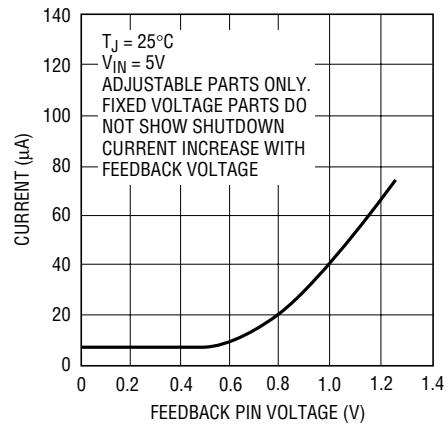

LT1500/01 • TPC05

PIN FUNCTIONS

SHDN: Logic Level Shutdown Pin. *This pin must be held high ($> 1.1V$) for the regulator to run.* SHDN can be tied directly to V_{IN} , even with $V_{IN} = 18V$. The low-battery detector remains active in shutdown, but all other circuitry is turned off.

V_{IN} : This pin supplies power to the regulator and is connected to one side of the inductor sense resistor. It should be bypassed close to the chip with a low ESR capacitor.

ISENSE: This is one end of the internal inductor-current sense resistor. With most applications, only the external inductor is tied to this pin.

GND: This pin carries only low level current in the LT1500, but it carries full switch current in the LT1501. The negative end of the input bypass capacitor should be connected close to this pin and the pin should go directly to the ground plane with the LT1501.

PGND (LT1500 Only): This pin is the emitter of the internal NPN power switch. Connect it directly to the ground plane.

SW: This is the collector of the internal NPN power switch. To avoid EMI and overvoltage spikes, keep connections to this pin very short.

LBI: This is the input to the low-battery detector with a threshold of 1.24V. Maximum pin voltage is 5V. Bypass LBI with a small filter capacitor when used. If unused, tie LBI to ground. The low-battery detector remains active in shutdown.

LBO : This is the open collector output of the low-battery detector. It will sink up to 2mA. Leave open if not used.

FB/ V_{OUT} : FB is the inverting input to the error amplifier with a regulating point of 1.265V and a typical bias current of 30nA. Bias current is reduced with a canceling circuit, so bias current could flow in either direction. FB is replaced with V_{OUT} on fixed voltage parts. V_{OUT} is the top of an internal divider that is connected to the internal FB node. A switch disconnects the divider in shutdown so that the divider current does not load V_{IN} through the inductor and catch diode.

NFB/SELECT (LT1500 Only): NFB is a second feedback node used to regulate a negative output voltage. Negative output voltages can be generated by using a transformer flyback circuit, a Cuk converter or a capacitor charge pump added to a boost converter. The regulating point for NFB is 1.265V and the internal resistance to ground is 100k Ω . External divider current should be 300 μ A or greater to avoid negative output voltage variations due to production variations in the internal resistor value. FB should be left open when using NFB.

On fixed voltage parts, NFB is replaced with Select. The Select pin is used to set output voltage at either 3.3V or 5V.

V_C (LT1500 Only): This is the output of the error amplifier and the input to the current comparator. The V_C pin voltage is about 700mV at very light loads and about 1.2V at full load. An internal comparator detects when the V_C voltage drops below about 750mV and shuts down the current comparator and the power switch biasing to reduce quiescent current. This forces the regulator to operate in Burst Mode operation.

SYNC (LT1500 Only): This is a logic level input used to synchronize switching frequency to an external clock. The sync signal overrides the internal current comparator and turns the switch on. Minimum sync pulse width should be 50ns and maximum width should be 300ns. A continuous high sync signal will force the power switch to stay on indefinitely and current will increase without limit. Don't do this!

SS (LT1500 Only): This is the soft start function using the base of a PNP transistor whose emitter is tied to the V_C pin. Grounding SS will turn off switching by pulling V_C low. A capacitor tied from SS to ground will force V_C to ramp up slowly during start-up at a rate set by the capacitor value and the internal 4 μ A pull-up current. An external resistor must be used to reset the capacitor voltage completely to 0V at power down.

APPLICATIONS INFORMATION

value, the peak-to-peak inductor current (set internally) and the values for V_{IN} and V_{OUT} . The LT1500 controls output voltage in continuous mode by adjusting the average value of inductor current while maintaining the peak-to-peak value of the current relatively constant, hence, the name “current mode architecture.”

The LT1500 sets the peak-to-peak value of switch current internally to establish operating frequency. This peak-to-peak value is scaled down somewhat at light load currents to avoid as long as possible the characteristic of other micropower converters wherein their switching frequency drops very low (into the audio range) at less than full load currents. At extremely light loads, even the LT1500 can no longer maintain higher frequency operation, and utilizes a Burst Mode operation to control output voltage.

Details of Continuous Mode Operation

At the start of a switch cycle, inductor current has decreased to the point where the voltage across R_{SENSE} is less than the internally generated voltage across R_h . This causes the current comparator output to go high and turn on the switch. At the same time, extra current is added to R_h via $S1$ to create hysteresis in the trip point of the comparator. This extra current is composed of a fixed amount ($I1$), and an amount proportional to average inductor current ($I2$). The presence of a variable $I2$ increases switching frequency at lighter loads to extend the load current range where high frequency operation is maintained and no Burst Mode operation exists.

With the switch turned on, inductor current will increase until the voltage drop across R_{SENSE} is equal to the higher voltage across R_h . Then the comparator output will go low, the switch will turn off and the current through R_h will be switched back to its lower value. Inductor current will decrease until the original condition is reached, completing one switch cycle.

Control of output voltage is maintained by adjusting the continuous current flowing through R_h . This affects both upper and lower inductor current trip levels at the same time. Continuous R_h current is controlled by the error amplifier which is comparing the voltage on the Feedback pin to the internal 1.265V reference. An internal frequency

compensation capacitor filters out most the ripple voltage at the amplifier output.

Operation at Light Loads

At light load currents the lower trip level (switch turn-on) for inductor current drops below zero. At first glance, this would seem to initiate a permanent switch off-state because the inductor current cannot reverse in a boost topology. In fact, what happens is that output voltage drops slightly between switch cycles, causing the error amplifier output to increase and bring the current trip level back up to zero. The switch then turns back on and inductor current increases to a value set by $I1$ ($I2$ is near zero at this point). The switch then turns off, and the inductor energy is delivered to the output, causing it to rise back up slightly. One or more switch cycles may be needed to raise the output voltage high enough that the amplifier output drops enough to force a sustained switch off period. The output voltage then slowly drops back low enough to cause the amplifier output to rise high enough to initiate a switch turn-on. Switching operation now consists of a series of bursts where the switch runs at normal frequency for one or more cycles, then turns off for a number of cycles. This Burst Mode operation is what allows the LT1500 to have micropower operation and high efficiency at very light loads.

Saving Current in Burst Mode Operation

Internal current drain for the LT1500 control circuitry is about $400\mu A$ when everything is operating. To achieve higher efficiency at extremely light loads, a special operating mode is initiated when the error amplifier output is toward the low end of its range. The adaptive bias circuit comparator detects that the error amplifier output is below a predetermined level and turns off the current comparator and switch driver biasing. This reduces current drain to about $200\mu A$, and forces a switch off state. Hysteresis in the comparator forces the device to remain in this micropower mode until the error amplifier output rises up beyond the original trip point. The regulated output voltage will fall slightly over a relatively long period of time (remember that load current is very low) until the error amplifier output rises enough to turn off the adaptive bias

APPLICATIONS INFORMATION

mode. Normal operation resumes for one or more switch cycles and the output voltage increases until the error amplifier output falls below threshold, initiating a new adaptive bias shutdown.

DESIGN GUIDE

Selecting Inductor Value

Inductor value is chosen as a compromise between size, switching frequency, efficiency and maximum output current. Larger inductor values become physically larger but provide higher output current and give better efficiency (because of the lower switching frequency). Low inductance minimizes size but may limit output current and the higher switching frequency reduces efficiency.

The simplest way to handle these trade-offs is to study the graphs in the Typical Performance Characteristics section. A few minutes with these graphs will clearly show the trade-offs and a value can be quickly chosen that meets the requirements of frequency, efficiency and output current. This leaves only physical size as the final consideration. The concern here is that for a given inductor value, smaller size usually means higher series resistance. The graphs showing efficiency loss vs inductor series resistance will allow a quick estimate of the additional losses associated with very small inductors.

One final consideration is inductor construction. Many small inductors are “open frame ferrites” such as rods or barrels. These geometries do not have a closed magnetic path, so they radiate significant B fields in the vicinity of the inductor. This can affect surrounding circuitry that is sensitive to magnetic fields. Closed geometries such as toroids or E-cores have very low stray B fields, but they are larger and more expensive (naturally).

Catch Diode

The catch diode in a boost converter has an average current equal to output current, but the peak current can be significantly higher. Maximum reverse voltage is equal to output voltage. A 0.5A Schottky diode like MBR0520L works well in nearly all applications.

Input Capacitor

Input capacitors for boost regulators are less critical than the output capacitor because the input capacitor ripple current is a simple triwave without the higher frequency harmonics found in the output capacitor current. Peak-to-peak current is less than 200mA and worst-case RMS ripple current in the input capacitor is less than 70mA.

Input capacitor series resistance (ESR) should be low enough to keep input ripple voltage to less than 100mV_{P-P}. This assumes that the capacitor is an aluminum or tantalum type where the capacitor reactance at the switching frequency is small compared to the ESR.

$$C \geq \frac{2}{\pi(f)(ESR)}$$

A typical input capacitor is a 33μF, 6V surface mount solid tantalum type TPS from AVX. It is a “C” case size, with 0.15Ω maximum ESR. Some caution must be used with solid tantalum input capacitors because they can be damaged with turn-on surge currents that occur when a low impedance power source is hot-switched to the input of the regulator. This problem is mitigated by using a capacitor with a voltage rating at least twice the highest expected input voltage. Consult with the manufacturer for additional guidelines.

If a ceramic input capacitor is used, different design criteria are used because these capacitors have extremely low ESR and are chosen for a minimum number of microfarads.

$$C(\text{Ceramic}) = \frac{1}{4f}$$

f = switching frequency

A typical unit is an AVX or Tokin 3.3μF or 4.7μF.

Output Capacitor

Output ripple voltage is determined by the impedance of the output capacitor at the switching frequency. Solid tantalum capacitors rated for switching applications are recommended. These capacitors are essentially resistive at frequencies above 50kHz, so ESR is the important factor in determining ripple voltage. A typical unit is a 220μF, 10V

APPLICATIONS INFORMATION

type TPS from AVX, or type 595D from Sprague. These have an ESR of 0.06Ω in a “E” case size. At lower output current levels, a $100\mu\text{F}$ unit in a “D” case size may be sufficient. Output ripple voltage can be calculated from:

$$V_{\text{RIPPLE}} = \text{ESR} \left[0.1 + \frac{1.2(I_{\text{OUT}})(V_{\text{OUT}})}{V_{\text{IN}}} \right]$$

Loop frequency stability is affected by the characteristics of the output capacitor. The ESR of the capacitor should be very low, and the capacitance must be large ($> 200\mu\text{F}$) to ensure good loop stability under worst-case conditions of low input voltage, higher output voltages, and high load currents. The 14-pin LT1500 can use external frequency compensation on the V_C pin to give good loop stability with smaller output capacitors. See Loop Stability section for details.

Precautions regarding solid tantalum capacitors for input bypassing do not apply to the output capacitor because turn-on surges are limited by the inductor and discharge surges do not harm the capacitors.

Setting Output Voltage

Preset 3.3V and 5V parts are available. For other voltage applications the adjustable part uses an external resistor divider to set output voltage. Bias current for the feedback (FB) pin is typically $\pm 30\text{nA}$ (it is internally compensated). Thevenin divider resistance should be $100\text{k}\Omega$ or less to keep bias current errors to a minimum. This leads to a value for R1 and R2 (see Figure 1) of:

$$R1 = \frac{100\text{k}\Omega(V_{\text{OUT}})}{1.265\text{V}}$$

$$R2 = \frac{R1(1.265)}{V_{\text{OUT}} - 1.265}$$

Example: $V_{\text{OUT}} = \text{xxV}$

$$R1 = \frac{100\text{k}\Omega(12)}{1.265} = 949\text{k} \text{ (use } 1\text{M)}$$

$$R2 = \frac{1\text{M}(1.265)}{12 - 1.265} = 118\text{k}$$

Note that there is an internal switch that disconnects the internal divider for fixed 3.3V and 5V parts in shutdown. This prevents the divider from adding to shutdown current. Without this switch, shutdown current increases because of the divider current directly, but even more so if the FB pin is held above 0.6V by the divider. See graphs in Typical Performance Characteristics.

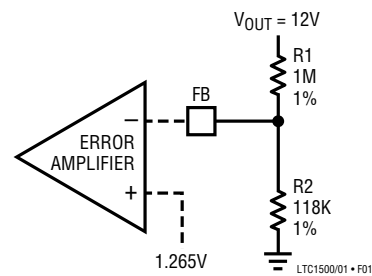

Figure 1. External Voltage Divider

Selectable Output (Fixed Voltage Parts)

The Select pin (available only on LT1500-3/5) allows the user to select either a 3.3V or 5V output. Floating the pin sets output voltage at 3.3V and grounding the pin sets output voltage at 5V. The equivalent circuit of the Select pin function is shown in Figure 2.

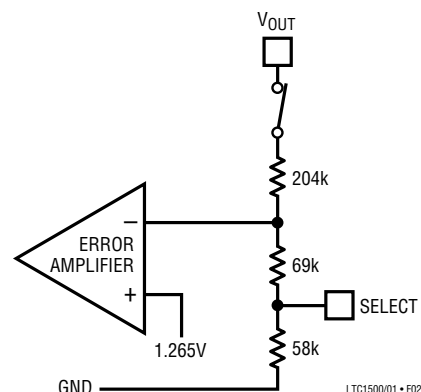

Figure 2. Schematic of Select Pin Function

Note that there is a switch in series with the V_{OUT} pin. This switch is turned off in shutdown to eliminate shutdown current drawn by the voltage divider. For adjustable parts

LT1500/LT1501

APPLICATIONS INFORMATION

with an external divider no switch exists and the divider current remains. There may be additional current drawn by the adjustable LT1500 in shutdown if the divider voltage at the feedback node exceeds 0.6V. See Typical Performance Characteristics.

Loop Stability

The LT1501 is internally compensated since the device has no spare pin for a compensation point. The LT1500 brings out the V_C pin to which an external series R_C network is connected. This provides roll-off for the error amplifier, ensuring overall loop stability. Typical values when using tantalum output capacitors are 1000pF and 100k Ω .

Transient response of Figure 3's circuit with a 30mA to 100mA load step is detailed in Figure 4. The maximum output disturbance is approximately 20mV. The "splitting" of the V_{OUT} trace when load current increases to 100mA is due to ESR of C_{OUT} . C_{OUT} can be replaced by a ceramic unit, which has lower ESR, size and cost. Figure 5 shows transient response to the same 30mA to 100mA load step, with $C_{OUT} = 15\mu\text{F}$ ceramic, $C_C = 2200\text{pF}$ and $R_C = 10\text{k}$. The maximum output disturbance in this case is 100mV.

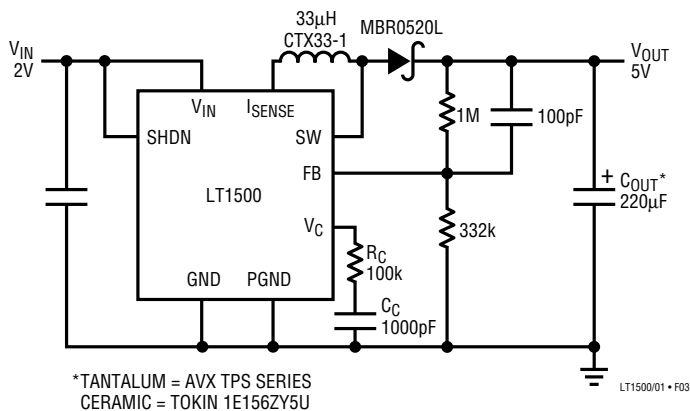

Figure 3. LT1500 2V to 5V Converter

Low-Battery Detector

The low-battery detector is a combined reference and comparator. It has a threshold of 1.24V with a typical input bias current of 20nA. In a typical application a resistor divider is connected across the battery input voltage with the center tap tied to Low Battery Input (LBI), see Figure 6. The suggested parallel resistance of the divider is 150k

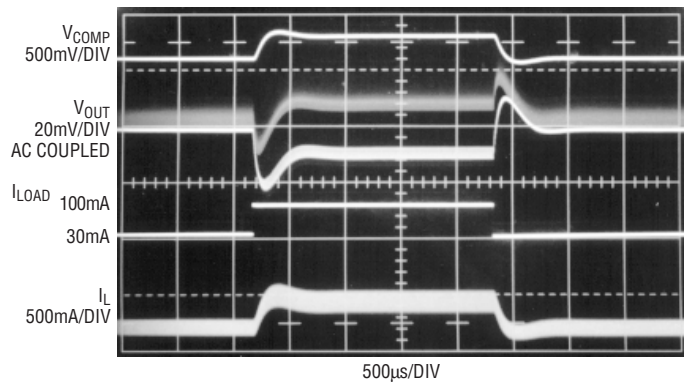

Figure 4. Transient Response of LT1500 with $R_C = 100\text{k}$, $C_C = 1000\text{pF}$ and $C_{OUT} = 220\mu\text{F}$. V_{OUT} Disturbance is 20mV

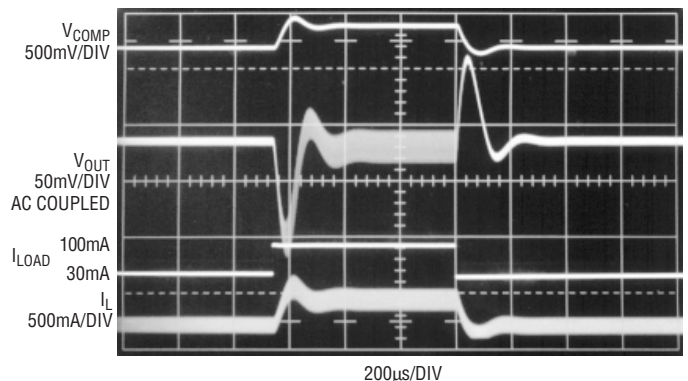

Figure 5. Transient Response of LT1500 with $R_C = 10\text{k}$, $C_C = 2200\text{pF}$ and $C_{OUT} = 15\mu\text{F}$ Ceramic. V_{OUT} Disturbance is 100mV

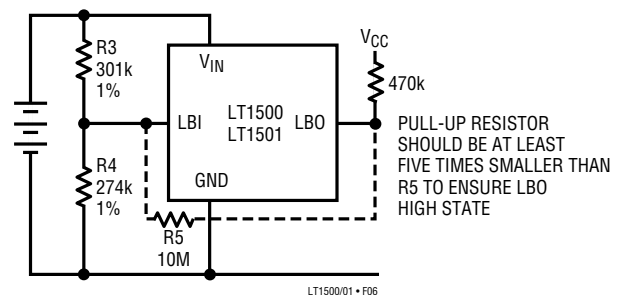

Figure 6. Low Battery Detection

APPLICATIONS INFORMATION

and it should be no more than 300k to keep bias current errors under 1%, giving:

$$R3 = \frac{R_{DIV}(V_{BAT})}{1.24V}$$

$$R4 = \frac{R3(1.24)}{V_{BAT} - 1.24}$$

V_{BAT} = low battery voltage

R_{DIV} = Thevenin divider resistance = R3 in parallel with R4

There is about 20mV of hysteresis at the LBI pin. Hysteresis can be increased by adding a resistor (R5) from the output (LBO) back to LBI. This resistor can be calculated from the following equation, but note that the equation for R4 will have to be changed when R5 is added.

$$R5 = \frac{R3(V_{CC})}{(V_{HYST}) - 17mV(V_{BAT})}$$

V_{CC} = supply voltage for LBO pull-up resistor

V_{HYST} = desired hysteresis at the battery

$$R4 \text{ (When R5 is Used)} = \frac{R3(R5)(1.24)}{R5(V_{BAT} - 1.24) + R3(V_{CC} - 1.24)}$$

The LBO pin is open collector. The external pull-up resistor value is determined by user needs. Generally the resistor is 100k to 1M to keep current drain low, but the LBO pin can sink several milliamperes if needed.

Example: low battery voltage = 2.5V, desired hysteresis = 200mV, V_{CC} = 5V.

Use R_{DIV} = 150k

$$R3 = \frac{150k(2.5)}{1.24} = 302k \text{ (use 301k, 1\%)}$$

$$R5 = \frac{301k(5V)}{(0.2) - 0.017(2.5)} = 9.56M \text{ (Use 10M)}$$

$$R4 = \frac{(301k)(10M)(1.24)}{10M(2.5 - 1.24) + 301k(5 - 1.24)} = 272k \text{ (Use 274k 1\%)}$$

The total divider resistance will be 274k + 301k = 575k, and this will draw about 7 μ A from a fully charged battery.

Synchronizing

The SYNC pin on the LT1500 can be used to synchronize switching frequency to an external clock. The pin should be driven with a 50ns to 300ns pulse which will trigger the switch to an on state. There is a fairly restricted range over which synchronizing will work, because the period between sync pulses must be greater than the natural on-time of the regulator when it is running unsynchronized, and the sync frequency must be greater than the unsynchronized switching frequency. This puts the following restrictions on synchronized operation:

$$f_{SYNC} > f_{NATURAL}$$

$$f_{SYNC} < \frac{f_{NATURAL}(V_{OUT})}{V_{OUT} - V_{IN}} \text{ (Use Minimum } V_{IN})$$

$f_{NATURAL}$ is the natural unsynchronized switching frequency of the regulator. It is a function of load current, so a careful check must be done to ensure that the above conditions are met under all load and input voltage conditions.

Soft Start (SS)

The LT1500 can be soft started by connecting a capacitor to the SS pin. This pin is the base of a PNP transistor whose emitter is tied to the V_C pin. Soft start action will occur over the range of 0V to 0.8V on the SS pin and the pin is clamped at 1.2V with an internal clamp. An internal 4 μ A pull-up current and the external capacitor value determine soft start time. In a typical application a 0.22 μ F capacitor is sufficient to limit input surges and prevent output overshoot, even with overcompensation on the V_C pin. Output voltages greater than 6V with very large output

APPLICATIONS INFORMATION

capacitors may require the capacitor to be larger. To ensure proper reset of the soft start capacitor, an external resistor must be connected in parallel with the capacitor. The resistor value should be 470k or more.

Calculating Temperature Rise

For most applications, temperature rise in the IC will be fairly low and will not be a problem. However, if load currents are near the maximum allowed and ambient temperatures are also high, a calculation should be done to ensure that the maximum junction temperature of 100°C is not exceeded. The calculations must account for power dissipation in the switch, the drive circuitry and the sense resistor.

$$P_{TOTAL} = \frac{(I_{OUT})^2 (R_{SW})(V_{OUT})(V_{OUT} - V_{IN})}{(V_{IN})^2} + \frac{I_{OUT}(V_{OUT} - V_{IN})}{30} + \frac{R_{SENSE}(I_{OUT} \cdot V_{OUT})^2}{(V_{IN})^2}$$

P_{TOTAL} = total device power dissipation

R_{SW} = switch resistance (0.72Ω max)

R_{SENSE} = sense resistance (0.42Ω max)

With $V_{IN} = -2.2V$, $V_{OUT} = 5V$, $I_{OUT} = 150mA$, an 8-pin SO package and maximum ambient temperature of 85°C (industrial range),

$$P_{TOTAL} = \frac{(0.15)^2(0.72)(5)(5 - 2.2)}{(2.2)^2} + \frac{0.15(5 - 2.2)}{30} + \frac{0.42(0.15 \cdot 5)^2}{(2.2)^2} = 0.47 + 0.014 + 0.049 = 0.11W$$

The SO package has a thermal resistance of 120°C/W, so maximum device temperature will be:

$$T_{JMAX} = 85^\circ C + 0.11W(120^\circ C/W) = 98^\circ C$$

PACKAGE DESCRIPTION Dimensions in inches (millimeters) unless otherwise noted.

S8 Package
8-Lead Plastic Small Outline (Narrow 0.150)
 (LTC DWG # 05-08-1610)

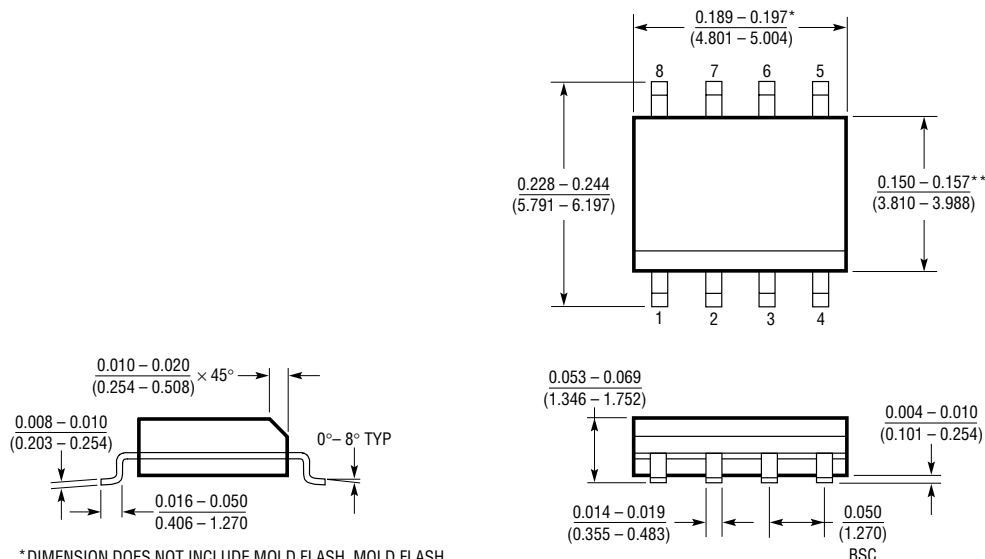

* DIMENSION DOES NOT INCLUDE MOLD FLASH. MOLD FLASH SHALL NOT EXCEED 0.006" (0.152mm) PER SIDE
 ** DIMENSION DOES NOT INCLUDE INTERLEAD FLASH. INTERLEAD FLASH SHALL NOT EXCEED 0.010" (0.254mm) PER SIDE

PACKAGE DESCRIPTION Dimensions in inches (millimeters) unless otherwise noted.

S Package
14-Lead Plastic Small Outline (Narrow 0.150)
 (LTC DWG # 05-08-1610)

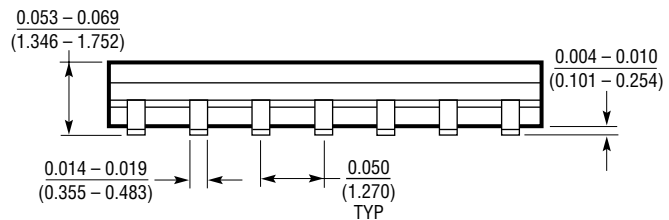
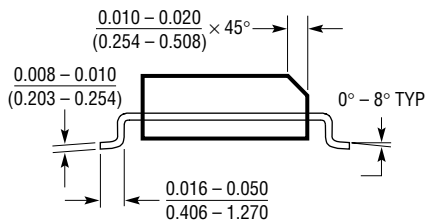
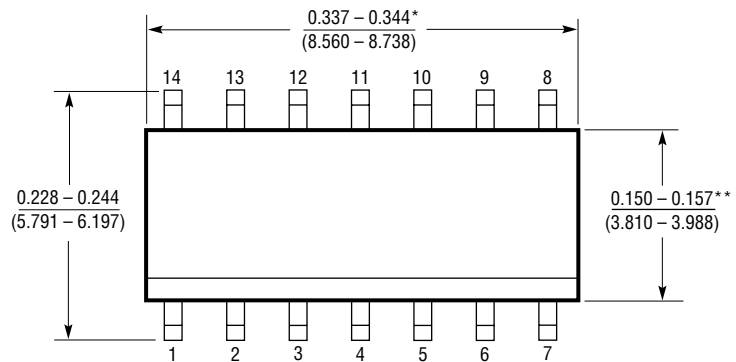

DIMENSION DOES NOT INCLUDE MOLD FLASH. MOLD FLASH SHALL NOT EXCEED 0.006 (0.152mm) PER SIDE

**DIMENSION DOES NOT INCLUDE INTERLEAD FLASH. INTERLEAD FLASH SHALL NOT EXCEED 0.010* (0.254mm) PER SIDE

S14 0695

TYPICAL APPLICATION

Typical LT1500 (14-Pin) Application, 2-Cell to 5V Converter

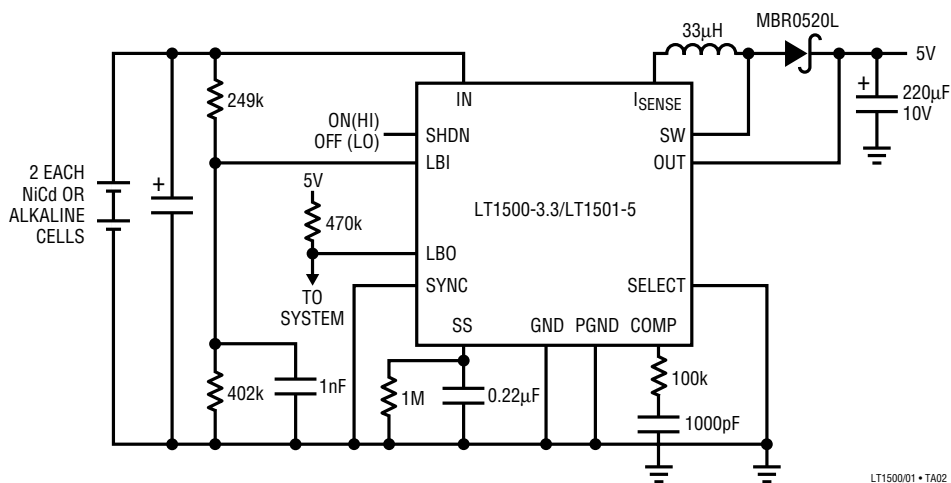

RELATED PARTS

PART NUMBER	DESCRIPTION	COMMENTS
LTC [®] 1163	Triple High Side Driver for 2-Cell Inputs	1.8V Minimum Input, Drives N-Channel MOSFETs
LTC1174	Micropower Step-Down DC/DC Converter	94% Efficiency, 130µA I _Q , 9V to 5V at 300mA
LT1302	High Output Current Micropower DC/DC Converter	5V/600mA from 2V, 2A Internal Switch, 200µA I _Q
LT1304	2-Cell Micropower DC/DC Converter	Low-Battery Detector Active in Shutdown
LTC1440/1/2	Ultralow Power Single/Dual Comparator with Reference	2.8µA I _Q , Adjustable Hysteresis
LTC1516	2-Cell to 5V Regulated Charge Pump	12µA I _Q , No Inductors, 5V at 50mA from 3V Input
LT1521	Micropower Low Dropout Linear Regulator	500mV Dropout, 300mA Current, 12µA I _Q