



# LT1881/LT1882

## Dual and Quad Rail-to-Rail Output, Picoamp Input Precision Op Amps

### FEATURES

- Offset Voltage: 50 $\mu$ V Maximum (LT1881A)
- Input Bias Current: 200pA Maximum (LT1881A)
- Offset Voltage Drift: 0.8 $\mu$ V/ $^{\circ}$ C Maximum
- Rail-to-Rail Output Swing
- Supply Range: 2.7V to 36V
- Operates with Single or Split Supplies
- Open-Loop Voltage Gain: 1 Million Minimum
- 1mA Maximum Supply Current Per Amplifier
- Stable at  $A_V = 1$ ,  $C_L = 1000$ pF
- Standard Pinouts

### APPLICATIONS

- Thermocouple Amplifiers
- Bridge Transducer Conditioners
- Instrumentation Amplifiers
- Battery-Powered Systems
- Photo Current Amplifiers

### DESCRIPTION

The LT<sup>®</sup>1881 and LT1882 op amps bring high accuracy input performance to amplifiers with rail-to-rail output swing. Input bias currents and capacitive load driving capabilities are superior to the similar LT1884 and LT1885 amplifiers, at the cost of a slight loss in speed. Input offset voltage is trimmed to less than 50 $\mu$ V and the low drift maintains this accuracy over the operating temperature range. Input bias currents are an ultralow 200pA maximum.

The amplifiers work on any total power supply voltage between 2.7V and 36V (fully specified from 5V to  $\pm 15$ V). Output voltage swings to within 40mV of the negative supply and 220mV of the positive supply make these amplifiers good choices for low voltage single supply operation.

Capacitive loads up to 1000pF can be driven directly in unity-gain follower applications.

The dual LT1881 and LT1881A are available with standard pinouts in S8 and PDIP packages. The quad LT1882 is in a 14-pin SO package. For a higher speed device with similar DC specifications, see the LT1884/LT1885.

LT, LTC and LT are registered trademarks of Linear Technology Corporation.

### TYPICAL APPLICATION

16-Bit Voltage Output DAC on  $\pm 5$ V Supply

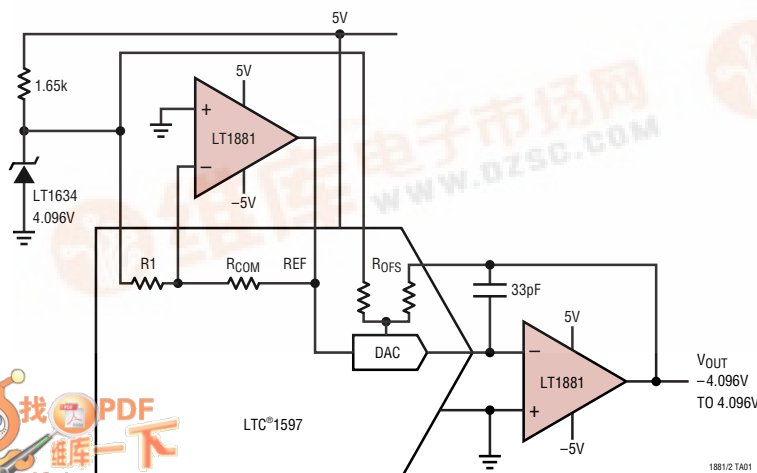

TC  $V_{OS}$  Distribution, Industrial Grade

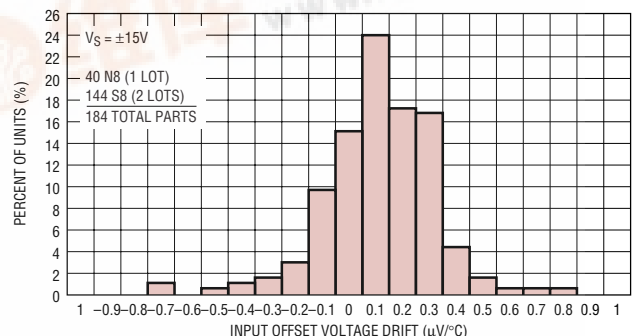

# LT1881/LT1882

## ABSOLUTE MAXIMUM RATINGS (Note 1)

Supply Voltage ( $V^+$ to $V^-$ ) .....	40V	Operating Temperature Range (Note 4) ..	$-40^{\circ}\text{C}$ to $85^{\circ}\text{C}$
Differential Input Voltage (Note 2) .....	$\pm 10\text{V}$	Specified Temperature Range (Note 5) ...	$-40^{\circ}\text{C}$ to $85^{\circ}\text{C}$
Input Voltage .....	$V^+$ to $V^-$	Maximum Junction Temperature .....	$150^{\circ}\text{C}$
Input Current (Note 2) .....	$\pm 10\text{mA}$	Storage Temperature Range .....	$-65^{\circ}\text{C}$ to $150^{\circ}\text{C}$
Output Short-Circuit Duration (Note 3) .....	Indefinite	Lead Temperature (Soldering, 10 sec) .....	$300^{\circ}\text{C}$

## PACKAGE/ORDER INFORMATION

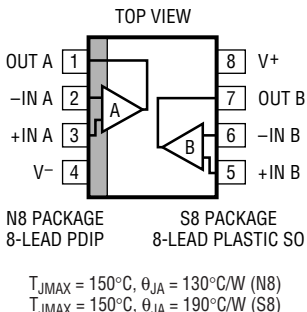
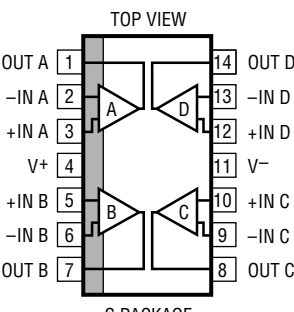
 <p>TOP VIEW</p> <p>N8 PACKAGE 8-LEAD PDIP</p> <p>S8 PACKAGE 8-LEAD PLASTIC SO</p> <p><math>T_{JMAX} = 150^{\circ}\text{C}</math>, <math>\theta_{JA} = 130^{\circ}\text{C/W}</math> (N8)  <math>T_{JMAX} = 150^{\circ}\text{C}</math>, <math>\theta_{JA} = 190^{\circ}\text{C/W}</math> (S8)</p>	ORDER PART NUMBER	 <p>TOP VIEW</p> <p>S PACKAGE 14-LEAD PLASTIC SO</p> <p><math>T_{JMAX} = 150^{\circ}\text{C}</math>, <math>\theta_{JA} = 150^{\circ}\text{C/W}</math></p>	ORDER PART NUMBER
	LT1881CN8 LT1881IN8 LT1881CS8 LT1881IS8 LT1881ACN8 LT1881AIN8 LT1881ACS8 LT1881AIS8		LT1882CS LT1882IS
	S8 PART MARKING		
	1881 1881I 1881A 1881AI		

Consult factory for parts specified with wider operating temperature ranges.

## ELECTRICAL CHARACTERISTICS

The ● denotes the specifications which apply over the full operating temperature range, otherwise specifications are at  $T_A = 25^{\circ}\text{C}$ . Single supply operation  $V_S = 5\text{V}$ ,  $0\text{V}$ ;  $V_{CM} = V_S/2$  unless otherwise noted. (Note 5)

SYMBOL	PARAMETER	CONDITIONS	MIN	TYP	MAX	UNITS
$V_{OS}$	Input Offset Voltage (LT1881A)	$0^{\circ}\text{C} < T_A < 70^{\circ}\text{C}$		25	50	$\mu\text{V}$
		$-40^{\circ}\text{C} < T_A < 85^{\circ}\text{C}$	●		85	$\mu\text{V}$
$V_{OS}$	Input Offset Voltage (LT1881/LT1882)	$0^{\circ}\text{C} < T_A < 70^{\circ}\text{C}$		30	80	$\mu\text{V}$
		$-40^{\circ}\text{C} < T_A < 85^{\circ}\text{C}$	●		125	$\mu\text{V}$
$\Delta V_{OS}/\Delta T$	Input Offset Voltage Drift (Note 6)	$0^{\circ}\text{C} < T_A < 70^{\circ}\text{C}$	●	0.3	0.8	$\mu\text{V}/^{\circ}\text{C}$
		$-40^{\circ}\text{C} < T_A < 85^{\circ}\text{C}$	●	0.3	0.8	$\mu\text{V}/^{\circ}\text{C}$
$\Delta V_{OS}/\Delta \text{TIME}$	Long-Term Input Offset Voltage Stability			0.3		$\mu\text{V}/\text{month}$
$I_{OS}$	Input Offset Current (LT1881A)	$0^{\circ}\text{C} < T_A < 70^{\circ}\text{C}$		100	200	$\text{pA}$
		$-40^{\circ}\text{C} < T_A < 85^{\circ}\text{C}$	●		250	$\text{pA}$
$I_{OS}$	Input Offset Current (LT1881/LT1882)	$0^{\circ}\text{C} < T_A < 70^{\circ}\text{C}$	●	150	500	$\text{pA}$
		$-40^{\circ}\text{C} < T_A < 85^{\circ}\text{C}$	●		600	$\text{pA}$
					700	$\text{pA}$

## ELECTRICAL CHARACTERISTICS

The ● denotes the specifications which apply over the full operating temperature range, otherwise specifications are at  $T_A = 25^\circ\text{C}$ .  
Single supply operation  $V_S = 5\text{V}$ ,  $0\text{V}$ ;  $V_{\text{CM}} = V_S/2$  unless otherwise noted. (Note 5)

SYMBOL	PARAMETER	CONDITIONS	MIN	TYP	MAX	UNITS
$I_B$	Input Bias Current (LT1881A)	$0^\circ\text{C} < T_A < 70^\circ\text{C}$	●	100	200	pA
		$-40^\circ\text{C} < T_A < 85^\circ\text{C}$	●		250	pA
	Input Bias Current (LT1881/LT1882)	$0^\circ\text{C} < T_A < 70^\circ\text{C}$	●	150	500	pA
		$-40^\circ\text{C} < T_A < 85^\circ\text{C}$	●		600	pA
	Input Noise Voltage	0.1Hz to 10Hz		0.5		$\mu\text{V}_{\text{P-P}}$
$e_n$	Input Noise Voltage Density	$f = 1\text{kHz}$		14		$\text{nV}/\sqrt{\text{Hz}}$
$i_n$	Input Noise Current Density	$f = 1\text{kHz}$		0.03		$\text{pA}/\sqrt{\text{Hz}}$
$R_{\text{IN}}$	Input Resistance	Differential Mode	●	20		$\text{M}\Omega$
		Common Mode	●	100		$\text{G}\Omega$
$C_{\text{IN}}$	Input Capacitance		●	2		pF
$V_{\text{CM}}$	Input Voltage Range		●	$V^- + 1.0$ $V^- + 1.2$	$V^+ - 1.0$ $V^+ - 1.2$	V V
CMRR	Common Mode Rejection Ratio	$1\text{V} < V_{\text{CM}} < 4\text{V}$	●	106	128	dB
		$1.2\text{V} < V_{\text{CM}} < 3.8\text{V}$	●	104		dB
PSRR	Power Supply Rejection Ratio	$V^- = 0\text{V}$ , $V_{\text{CM}} = 1.5\text{V}$	●	106	132	dB
		$0^\circ\text{C} < T_A < 85^\circ\text{C}$ , $2.7\text{V} < V^+ < 32\text{V}$ $T_A = -40^\circ\text{C}$ , $3\text{V} < V^+ < 32\text{V}$	●	106	132	dB
	Minimum Operating Supply Voltage		●	2.4	2.7	V
$A_{\text{VOL}}$	Large-Signal Voltage Gain	$R_L = 10\text{k}$ ; $1\text{V} < V_{\text{OUT}} < 4\text{V}$	●	500	1600	V/mV
			●	350		V/mV
		$R_L = 2\text{k}$ ; $1\text{V} < V_{\text{OUT}} < 4\text{V}$	●	300	800	V/mV
			●	250		V/mV
		$R_L = 1\text{k}$ ; $1\text{V} < V_{\text{OUT}} < 4\text{V}$	●	250	400	V/mV
			●	200		V/mV
$V_{\text{OL}}$	Output Voltage Swing Low	No Load	●	20	40	mV
		$I_{\text{SINK}} = 100\mu\text{A}$	●	25	50	mV
		$I_{\text{SINK}} = 1\text{mA}$	●	70	150	mV
		$I_{\text{SINK}} = 5\text{mA}$	●	270	600	mV
$V_{\text{OH}}$	Output Voltage Swing High (Referred to $V^+$ )	No Load	●	120	220	mV
		$I_{\text{SOURCE}} = 100\mu\text{A}$	●	130	230	mV
		$I_{\text{SOURCE}} = 1\text{mA}$	●	180	300	mV
		$I_{\text{SOURCE}} = 5\text{mA}$	●	360	600	mV
$I_S$	Supply Current Per Amplifier	$V_S = 3\text{V}$ , $0\text{V}$	●	0.45	0.65	0.85
			●			1.2
		$V_S = 5\text{V}$ , $0\text{V}$	●	0.5	0.65	0.9
			●			1.4
		$V_S = 12\text{V}$ , $0\text{V}$	●	0.5	0.70	1.0
			●			1.5
$I_{\text{SC}}$	Short-Circuit Current	$V_{\text{OUT}}$ Short to GND	●	15	30	mA
		$V_{\text{OUT}}$ Short to $V^+$	●	15	30	mA
GBW	Gain Bandwidth Product	$f = 20\text{kHz}$		0.35	1.0	MHz
	Channel Separation	$f = 1\text{kHz}$		120		dB
$t_S$	Settling Time	0.01%, $V_{\text{OUT}} = 1.5\text{V}$ to $3.5\text{V}$ , $A_V = -1$ , $R_L = 2\text{k}$		30		$\mu\text{s}$

# LT1881/LT1882

## ELECTRICAL CHARACTERISTICS

The ● denotes the specifications which apply over the full operating temperature range, otherwise specifications are at  $T_A = 25^\circ\text{C}$ .  
Single supply operation  $V_S = 5\text{V}$ ,  $0\text{V}$ ;  $V_{CM} = V_S/2$  unless otherwise noted. (Note 5)

SYMBOL	PARAMETER	CONDITIONS	MIN	TYP	MAX	UNITS
SR <sup>+</sup>	Slew Rate Positive	$A_V = -1$	0.15 0.12	0.35		V/ $\mu\text{s}$ V/ $\mu\text{s}$
SR <sup>-</sup>	Slew Rate Negative	$A_V = -1$	0.11 0.08	0.18		V/ $\mu\text{s}$ V/ $\mu\text{s}$
FPBW	Full-Power Bandwidth	$V_{OUT} = 4V_{P-P}$ (Note 10)	8.75 6.35	14		kHz kHz
$\Delta V_{OS}$	Offset Voltage Match (LT1881A)	(Note 7)		30	70	$\mu\text{V}$
		$0^\circ\text{C} < T_A < 70^\circ\text{C}$			125	$\mu\text{V}$
		$-40^\circ\text{C} < T_A < 85^\circ\text{C}$			160	$\mu\text{V}$
$\Delta V_{OS}$	Offset Voltage Match (LT1881/LT1882)	(Note 7)		35	125	$\mu\text{V}$
		$0^\circ\text{C} < T_A < 70^\circ\text{C}$			175	$\mu\text{V}$
		$-40^\circ\text{C} < T_A < 85^\circ\text{C}$			235	$\mu\text{V}$
	Offset Voltage Match Drift	(Notes 6, 7)		0.4	1.2	$\mu\text{V}/^\circ\text{C}$
$\Delta I_{B+}$	Noninverting Bias Current Match (LT1881A)	(Notes 7, 8)		200	300	$\rho\text{A}$
		$0^\circ\text{C} < T_A < 70^\circ\text{C}$			400	$\rho\text{A}$
		$-40^\circ\text{C} < T_A < 85^\circ\text{C}$			500	$\rho\text{A}$
$\Delta I_{B+}$	Noninverting Bias Current Match (LT1881/LT1882)	(Notes 7, 8)		250	700	$\rho\text{A}$
		$0^\circ\text{C} < T_A < 70^\circ\text{C}$			900	$\rho\text{A}$
		$-40^\circ\text{C} < T_A < 85^\circ\text{C}$			1000	$\rho\text{A}$
$\Delta\text{CMRR}$	Common Mode Rejection Match	(Notes 7, 9)	102	125		dB
$\Delta\text{PSRR}$	Power Supply Rejection Match (Notes 7, 9)	$V^- = 0\text{V}$ , $V_{CM} = 1.5\text{V}$				
		$0^\circ\text{C} < T_A < 85^\circ\text{C}$ , $2.7\text{V} < V^+ < 32\text{V}$	104	126		dB
		$T_A = -40^\circ\text{C}$ , $3\text{V} < V^+ < 32\text{V}$	104	126		dB

The ● denotes the specifications which apply over the full operating temperature range, otherwise specifications are at  $T_A = 25^\circ\text{C}$ .  
Split supply operation  $V_S = \pm 15\text{V}$ ,  $V_{CM} = 0\text{V}$  unless otherwise noted. (Note 5)

SYMBOL	PARAMETER	CONDITIONS	MIN	TYP	MAX	UNITS
$V_{OS}$	Input Offset Voltage (LT1881A)	$0^\circ\text{C} < T_A < 70^\circ\text{C}$		25	50	$\mu\text{V}$
		$-40^\circ\text{C} < T_A < 85^\circ\text{C}$			85	$\mu\text{V}$
					110	$\mu\text{V}$
$V_{OS}$	Input Offset Voltage (LT1881/LT1882)	$0^\circ\text{C} < T_A < 70^\circ\text{C}$		30	80	$\mu\text{V}$
		$-40^\circ\text{C} < T_A < 85^\circ\text{C}$			125	$\mu\text{V}$
					150	$\mu\text{V}$
$\Delta V_{OS}/\Delta T$	Input Offset Voltage Drift (Note 6)	$0^\circ\text{C} < T_A < 70^\circ\text{C}$		0.3	0.8	$\mu\text{V}/^\circ\text{C}$
		$-40^\circ\text{C} < T_A < 85^\circ\text{C}$		0.3	0.8	$\mu\text{V}/^\circ\text{C}$
$\Delta V_{OS}/\Delta\text{TIME}$	Long-Term Input Offset Voltage Stability			0.3		$\mu\text{V}/\text{month}$
$I_{OS}$	Input Offset Current (LT1881A)	$0^\circ\text{C} < T_A < 70^\circ\text{C}$		150	200	$\rho\text{A}$
		$-40^\circ\text{C} < T_A < 85^\circ\text{C}$			250	$\rho\text{A}$
					300	$\rho\text{A}$
$I_{OS}$	Input Offset Current (LT1881/LT1882)	$0^\circ\text{C} < T_A < 70^\circ\text{C}$		150	500	$\rho\text{A}$
		$-40^\circ\text{C} < T_A < 85^\circ\text{C}$			600	$\rho\text{A}$
					700	$\rho\text{A}$

## ELECTRICAL CHARACTERISTICS

The ● denotes the specifications which apply over the full operating temperature range, otherwise specifications are at  $T_A = 25^\circ\text{C}$ . Split supply operation  $V_S = \pm 15\text{V}$ ,  $V_{CM} = 0\text{V}$  unless otherwise noted. (Note 5)

SYMBOL	PARAMETER	CONDITIONS	MIN	TYP	MAX	UNITS
$I_B$	Input Bias Current (LT1881A)	$0^\circ\text{C} < T_A < 70^\circ\text{C}$	●	150	200	$\mu\text{A}$
		$-40^\circ\text{C} < T_A < 85^\circ\text{C}$	●		250	$\mu\text{A}$
	Input Bias Current (LT1881/LT1882)	$0^\circ\text{C} < T_A < 70^\circ\text{C}$	●	150	500	$\mu\text{A}$
		$-40^\circ\text{C} < T_A < 85^\circ\text{C}$	●		600	$\mu\text{A}$
	Input Noise Voltage	0.1Hz to 10Hz		0.5		$\mu\text{V}_{p-p}$
$e_n$	Input Noise Voltage Density	$f = 1\text{kHz}$		14		$\text{nV}/\sqrt{\text{Hz}}$
$i_n$	Input Noise Current Density	$f = 1\text{kHz}$		0.03		$\text{pA}/\sqrt{\text{Hz}}$
$R_{IN}$	Input Resistance	Differential Mode	●	20		$\text{M}\Omega$
		Common Mode	●	100		$\text{G}\Omega$
$C_{IN}$	Input Capacitance		●	2		$\text{pF}$
$V_{CM}$	Input Voltage Range		●	$V^- + 1.0$	$V^+ - 1.0$	$\text{V}$
				$V^- + 1.2$	$V^+ - 1.2$	$\text{V}$
CMRR	Common Mode Rejection Ratio	$-13.5\text{V} < V_{CM} < 13.5\text{V}$	●	114	130	$\text{dB}$
+PSRR	Positive Power Supply Rejection Ratio	$V^- = -15\text{V}$ , $V_{CM} = 0\text{V}$ ; $1.5\text{V} < V^+ < 18\text{V}$	●	110	132	$\text{dB}$
-PSRR	Negative Power Supply Rejection Ratio	$V^+ = 15\text{V}$ , $V_{CM} = 0\text{V}$ ; $-1.5\text{V} < V^- < -18\text{V}$	●	106	132	$\text{dB}$
	Minimum Operating Supply Voltage		●	$\pm 1.2$	$\pm 1.35$	$\text{V}$
$A_{VOL}$	Large-Signal Voltage Gain	$R_L = 10\text{k}$ ; $-13.5\text{V} < V_{OUT} < 13.5\text{V}$	●	1000	1600	$\text{V}/\text{mV}$
			●	700		$\text{V}/\text{mV}$
		$R_L = 2\text{k}$ ; $-13.5\text{V} < V_{OUT} < 13.5\text{V}$	●	175	420	$\text{V}/\text{mV}$
		●	125		$\text{V}/\text{mV}$	
		$R_L = 1\text{k}$ ; $-12\text{V} < V_{OUT} < 12\text{V}$	●	90	230	$\text{V}/\text{mV}$
			●	65		$\text{V}/\text{mV}$
$V_{OL}$	Output Voltage Swing Low (Referred to $V_{EE}$ )	No Load	●	20	40	$\text{mV}$
		$I_{SINK} = 100\mu\text{A}$	●	25	50	$\text{mV}$
		$I_{SINK} = 1\text{mA}$	●	70	150	$\text{mV}$
		$I_{SINK} = 5\text{mA}$	●	270	600	$\text{mV}$
$V_{OH}$	Output Voltage Swing High (Referred to $V_{CC}$ )	No Load	●	160	220	$\text{mV}$
		$I_{SOURCE} = 100\mu\text{A}$	●	160	230	$\text{mV}$
		$I_{SOURCE} = 1\text{mA}$	●	180	300	$\text{mV}$
		$I_{SOURCE} = 5\text{mA}$	●	360	600	$\text{mV}$
$I_S$	Supply Current Per Amplifier	$V_S = \pm 15\text{V}$	●	0.5	0.85	$\text{mA}$
					1.1	$\text{mA}$
					1.6	$\text{mA}$
$I_{SC}$	Short-Circuit Current	$V_{OUT}$ Short to $V^-$	●	20	40	$\text{mA}$
			●	15	40	$\text{mA}$
		$V_{OUT}$ Short to $V^+$	●	20	30	$\text{mA}$
			●	15	30	$\text{mA}$
GBW	Gain Bandwidth Product	$f = 20\text{kHz}$		0.4	0.85	$\text{MHz}$
	Channel Separation	$f = 1\text{kHz}$		120		$\text{dB}$
$t_S$	Settling Time	0.01%, $V_{OUT} = -5\text{V}$ to $5\text{V}$ , $A_V = -1$ , $R_L = 2\text{k}$		35		$\mu\text{s}$
$SR^+$	Slew Rate Positive	$A_V = -1$	●	0.21	0.4	$\text{V}/\mu\text{s}$
				0.18		$\text{V}/\mu\text{s}$

# LT1881/LT1882

## ELECTRICAL CHARACTERISTICS

The ● denotes the specifications which apply over the full operating temperature range, otherwise specifications are at  $T_A = 25^\circ\text{C}$ . Split supply operation  $V_S = \pm 15\text{V}$ ,  $V_{CM} = 0\text{V}$  unless otherwise noted. (Note 5)

SYMBOL	PARAMETER	CONDITIONS	MIN	TYP	MAX	UNITS
SR <sup>-</sup>	Slew Rate Negative	$A_V = -1$	0.13 0.1	0.20		V/ $\mu\text{s}$ V/ $\mu\text{s}$
FPBW	Full-Power Bandwidth	$V_{OUT} = 28\text{V}_{P-P}$ (Note 10)	1.47 1.13	2.25		kHz kHz
$\Delta V_{OS}$	Offset Voltage Match (LT1881/LT1882)	(Note 5) $0^\circ\text{C} < T_A < 70^\circ\text{C}$ $-40^\circ\text{C} < T_A < 85^\circ\text{C}$		42	125	$\mu\text{V}$ $\mu\text{V}$ $\mu\text{V}$
	Offset Voltage Match (LT1881A)	$0^\circ\text{C} < T_A < 70^\circ\text{C}$ $-40^\circ\text{C} < T_A < 85^\circ\text{C}$		35	70	$\mu\text{V}$ $\mu\text{V}$ $\mu\text{V}$
	Offset Voltage Match Drift	(Notes 6, 7)		0.4	1.1	$\mu\text{V}/^\circ\text{C}$
$\Delta I_{B+}$	Noninverting Bias Current Match (LT1881/LT1882)	(Notes 7, 8) $0^\circ\text{C} < T_A < 70^\circ\text{C}$ $-40^\circ\text{C} < T_A < 85^\circ\text{C}$		240	700	$\rho\text{A}$ $\rho\text{A}$ $\rho\text{A}$
	Noninverting Bias Current Match (LT1881A)	$0^\circ\text{C} < T_A < 70^\circ\text{C}$ $-40^\circ\text{C} < T_A < 85^\circ\text{C}$		200	300	$\rho\text{A}$ $\rho\text{A}$ $\rho\text{A}$
$\Delta\text{CMRR}$	Common Mode Rejection Match	(Notes 7, 9)	110	125		dB
$\Delta+\text{PSRR}$	Positive Power Supply Rejection Match	$V^- = -15\text{V}$ , $V_{CM} = 0\text{V}$ , $1.5\text{V} < V^+ < 18\text{V}$ , (Notes 7, 9)	108	130		dB
$\Delta-\text{PSRR}$	Negative Power Supply Rejection Match	$V^+ = 15\text{V}$ , $V_{CM} = 0\text{V}$ , $-1.5\text{V} < V^- < -18\text{V}$ , (Notes 7, 9)	104	130		dB

**Note 1:** Absolute Maximum Ratings are those values beyond which the life of a device may be impaired.

**Note 2:** The inputs are protected by internal resistors and back-to-back diodes. If the differential input voltage exceeds  $\pm 0.7\text{V}$ , the input current should be limited externally to less than 10mA.

**Note 3:** A heat sink may be required to keep the junction temperature below absolute maximum.

**Note 4:** The LT1881C, LT1882C, LT1881I and LT1882I are guaranteed functional over the operating temperature range of  $-40^\circ\text{C}$  to  $85^\circ\text{C}$ .

**Note 5:** The LT1881C and LT1882C are designed, characterized and expected to meet specified performance from  $-40^\circ\text{C}$  to  $85^\circ\text{C}$  but are not tested or QA sampled at these temperatures. The LT1881I and LT1882I are guaranteed to meet specified performance from  $-40^\circ\text{C}$  to  $85^\circ\text{C}$ .

**Note 6:** This parameter is not 100% tested.

**Note 7:** Matching parameters are the difference between amplifiers A and B in the LT1881; and between amplifiers A and D and B and C in the LT1882.

**Note 8:** This parameter is the difference between the two noninverting input bias currents.

**Note 9:**  $\Delta\text{CMRR}$  and  $\Delta\text{PSRR}$  are defined as follows: CMRR and PSRR are measured in  $\mu\text{V}/\text{V}$  on each amplifier. The difference is calculated in  $\mu\text{V}/\text{V}$  and then converted to dB.

**Note 10:** Full power bandwidth is calculated from the slew rate:  $\text{FPBW} = \text{SR}/2\pi V_P$ .

# TYPICAL PERFORMANCE CHARACTERISTICS

**Supply Current per Amplifier vs Supply Voltage**

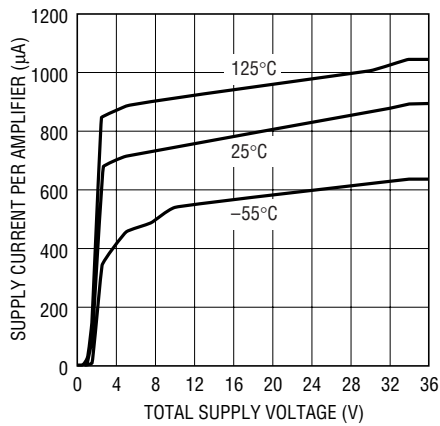

1881/2 G01

**Slew Rate vs Supply Voltage**

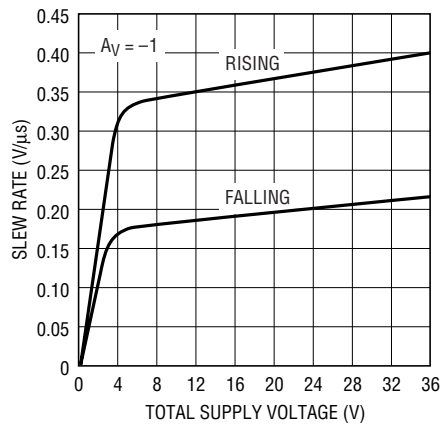

1881/2 G02

**Slew Rate vs Temperature**

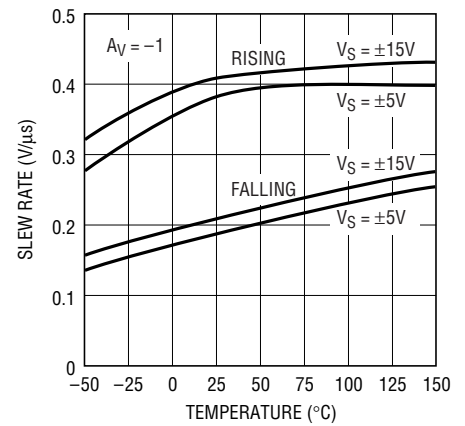

1881/2 G03

**Settling Time vs Output Step**

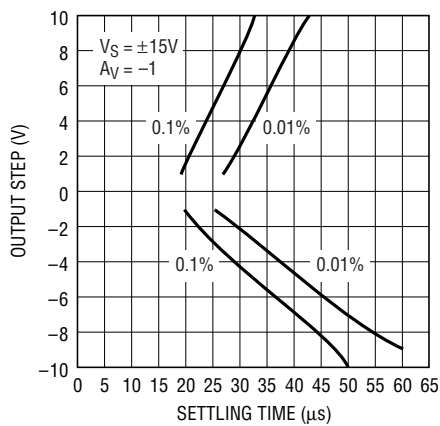

1881/2 G04

**Settling Time vs Output Step**

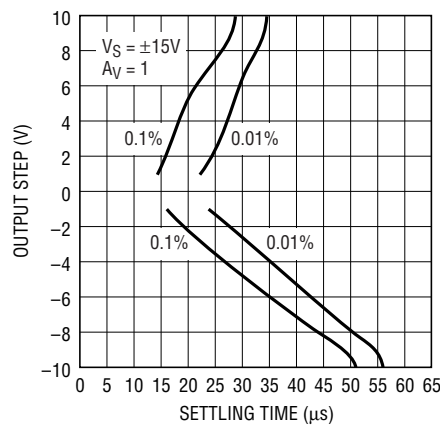

1881/2 G05

**Gain Bandwidth Product vs Supply Voltage**

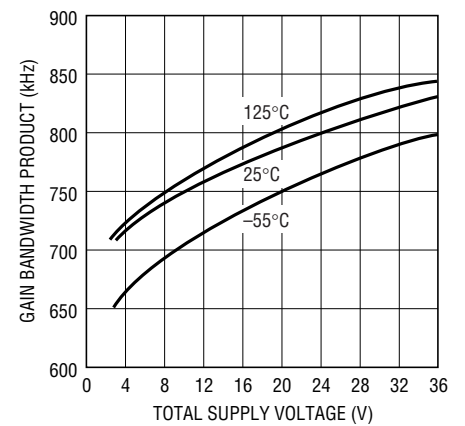

1881/2 G06

**Phase Margin vs Supply Voltage**

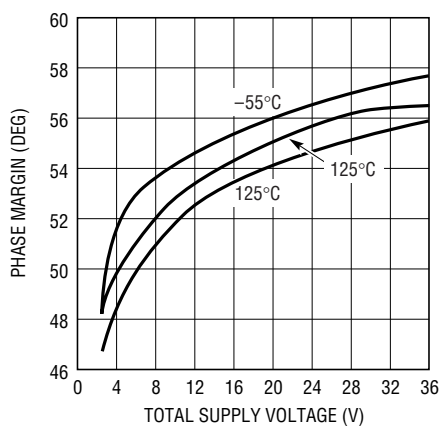

1881/2 G07

**Gain vs Frequency, Av = -1**

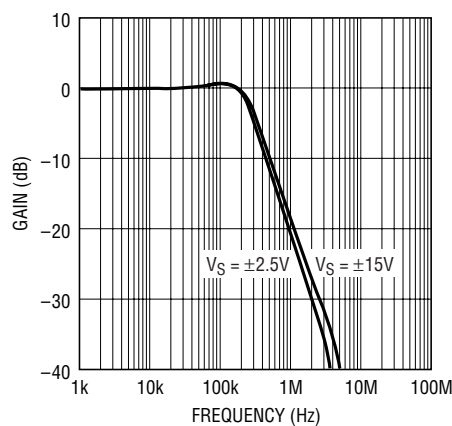

1881/2 G08

**Gain vs Frequency, Av = 1**

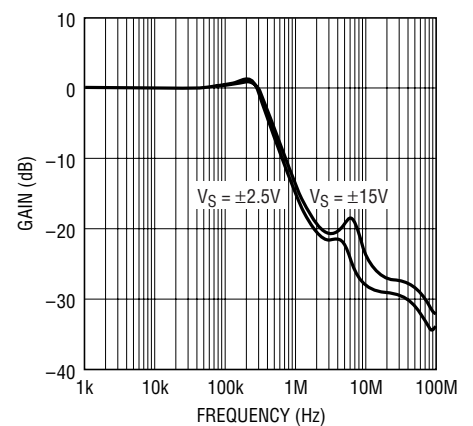

1881/2 G09

## TYPICAL PERFORMANCE CHARACTERISTICS

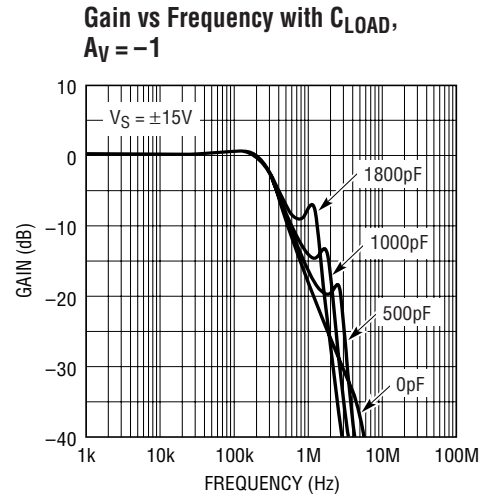
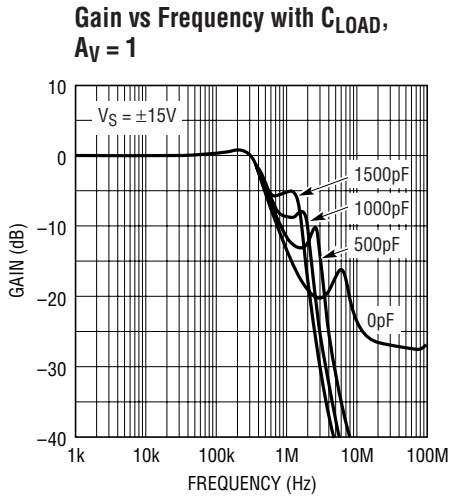

**Large Signal Response,  $A_V = -1$**

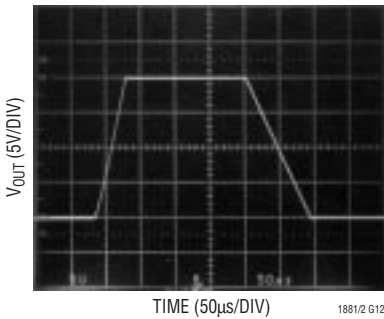

**Large Signal Response,  $A_V = 1$**

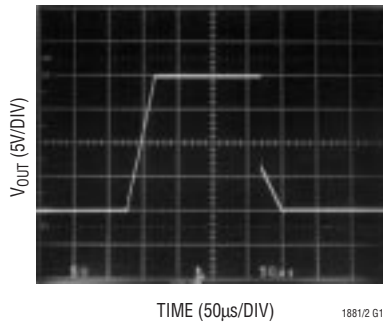

**Small Signal Response,  $A_V = -1$ , No Load**

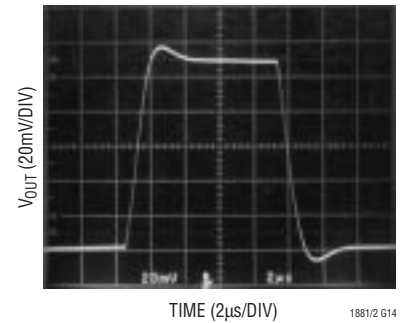

**Small Signal Response,  $A_V = -1$ ,  $C_L = 1000pF$**

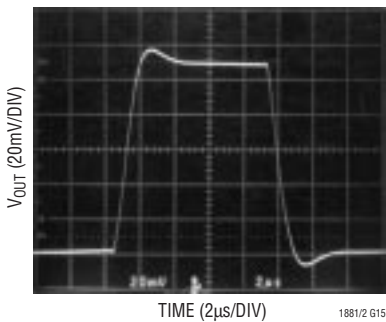

**Small Signal Response,  $A_V = 1$ ,  $R_L = 2k$**

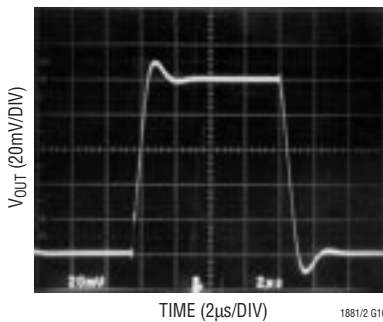

**Small Signal Response,  $A_V = 1$ ,  $C_L = 500pF$**

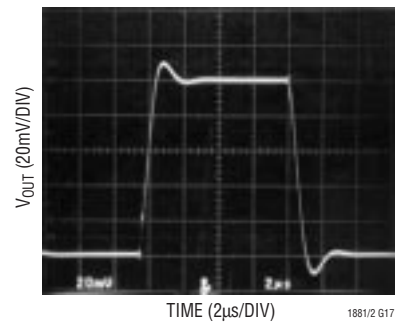



# TYPICAL PERFORMANCE CHARACTERISTICS

**LT1881  $V_{OS}$  Distribution,  $T_A = 25^\circ\text{C}$**

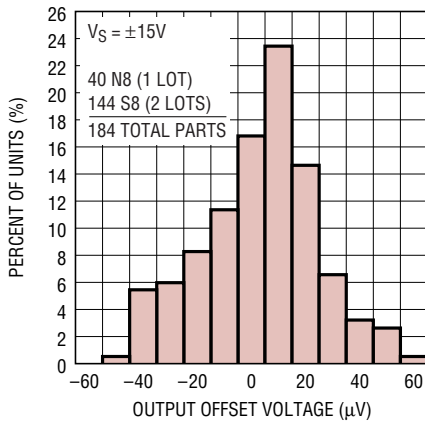

1881/2 G18

**LT1881S8 Voltage Offset vs Temperature**

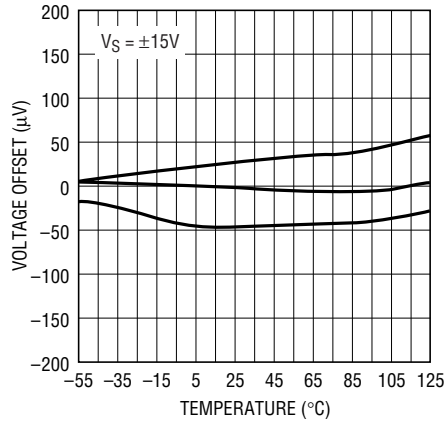

1881/2 G19

**Warm-Up Drift vs Time**

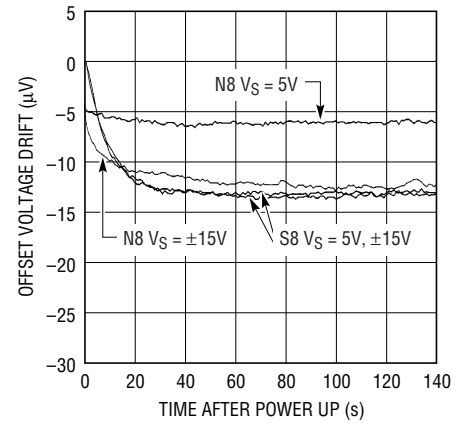

1881/2 G20

**LT1881 Input Bias Current vs Common Mode Voltage**

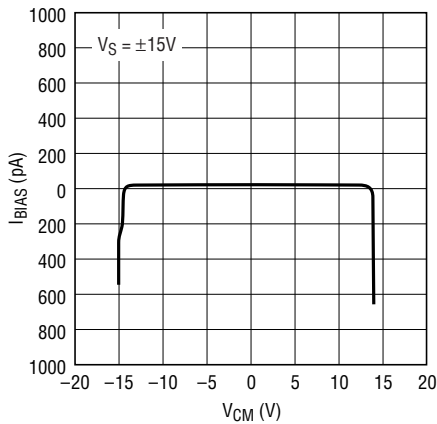

1881/2 G21

**LT1881 Input Bias Current vs Temperature**

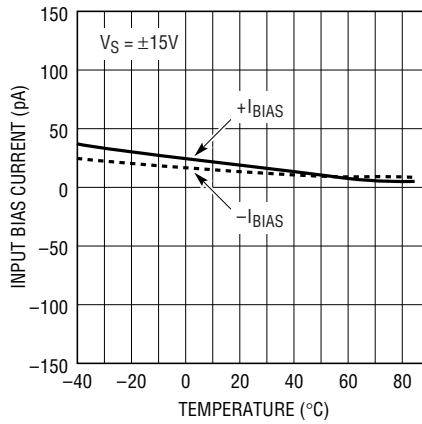

1881/2 G22

**LT1881 Input Common Mode Range vs Supply Voltage**

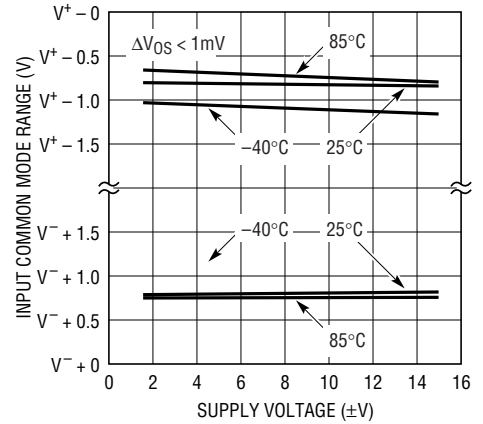

1881/2 G23

**LT1881 Input Common Mode Voltage vs Temperature**

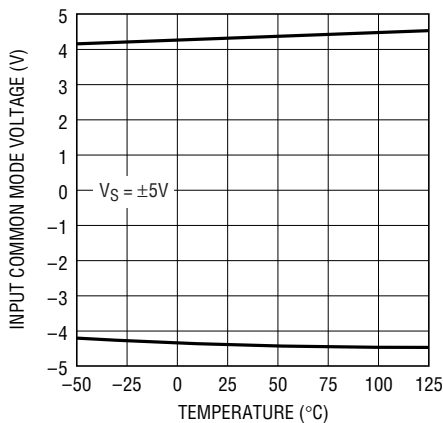

1881/2 G24

**LT1881 Output Voltage Swing vs Supply Voltage**

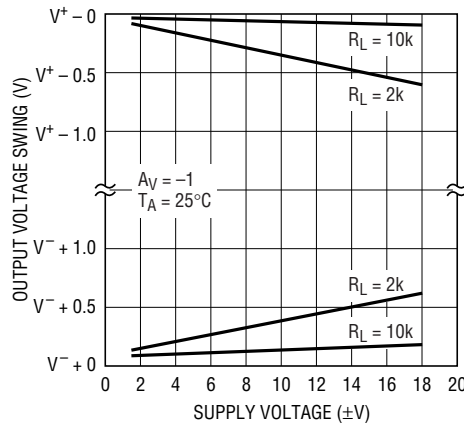

1881/2 G25

**LT1881 Output Saturation Voltage vs Load Current (Output High)**

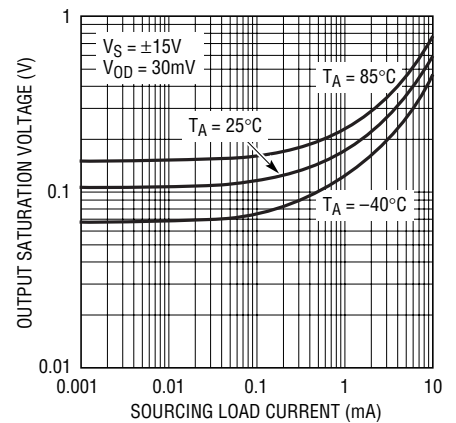

1881/2 G26

# LT1881/LT1882

## TYPICAL PERFORMANCE CHARACTERISTICS

**LT1881 Output Saturation Voltage vs Load Current (Output Low)**

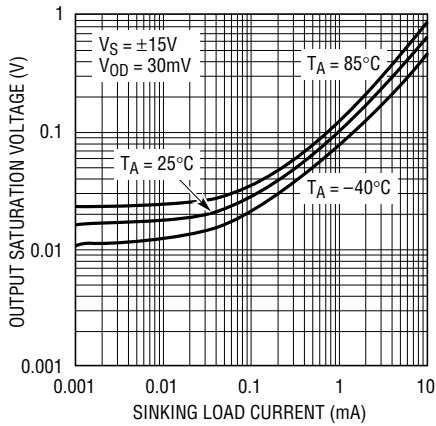

**LT1881 Output Short-Circuit Current vs Temperature**

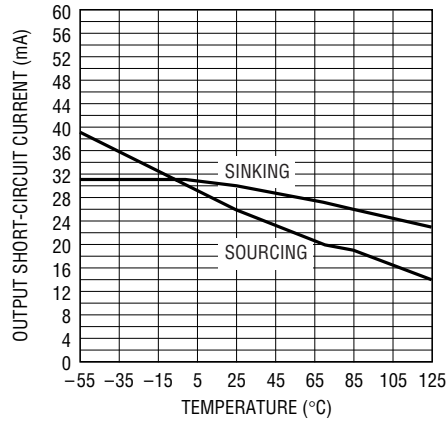

**LT1881 Output Voltage vs Large Input Voltage**

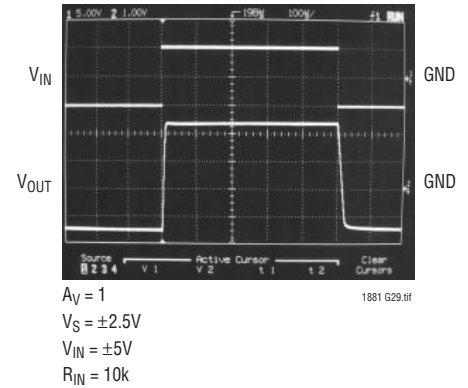

**LT1881 Open-Loop Gain vs Frequency**

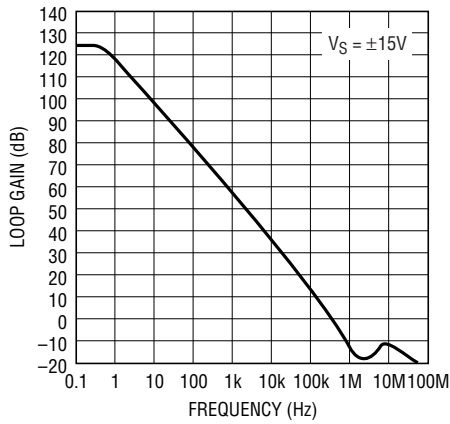

**LT1881 Open-Loop Gain and Phase vs Frequency**

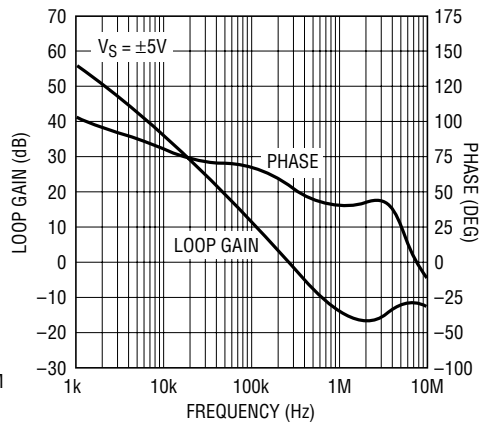

**LT1881 Channel Separation vs Frequency**

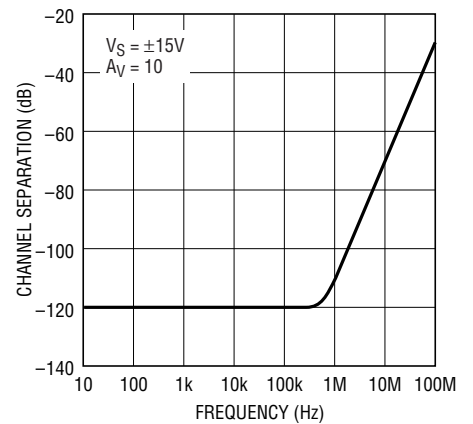

**Gain Bandwidth Product vs Temperature**

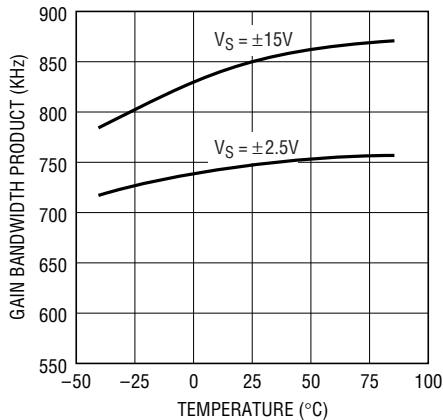

**Output Impedance vs Frequency**

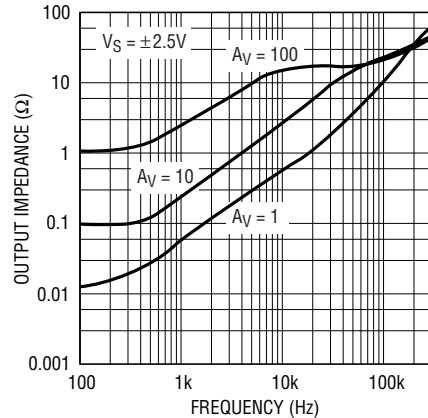

**LT1881 PSRR vs Frequency**

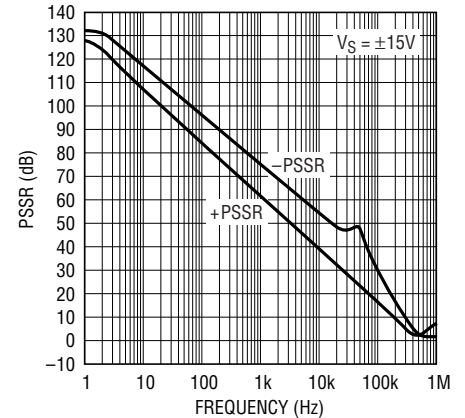

# TYPICAL PERFORMANCE CHARACTERISTICS

**Common Mode Rejection Ratio vs Frequency**

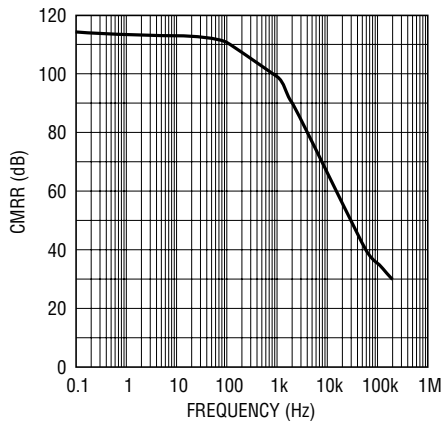

**LT1881 0.1Hz to 10Hz Noise**

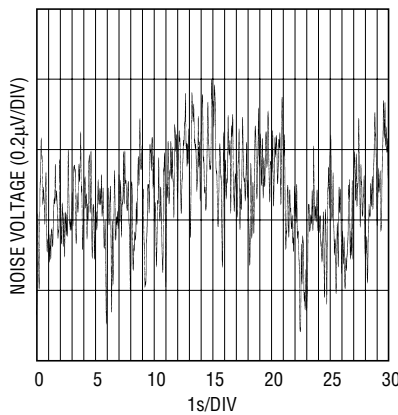

**LT1881 Noise Voltage vs Frequency**

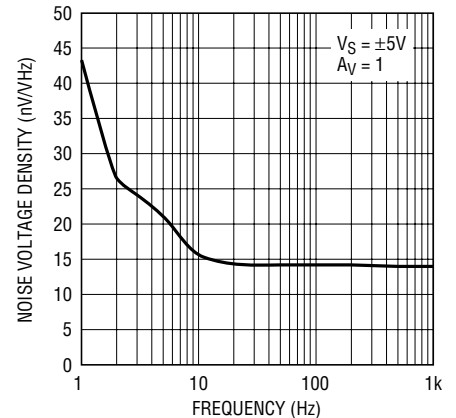

**LT1881 Noise Current Density vs Frequency**

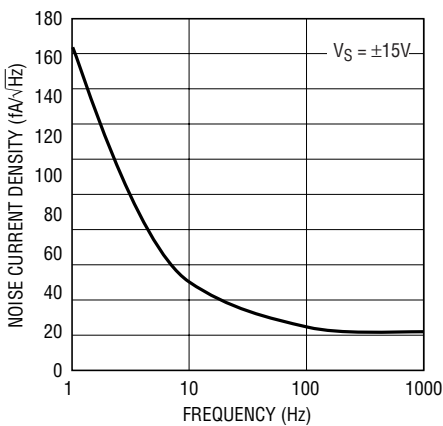

**LT1881A Total Noise vs Source Resistance**

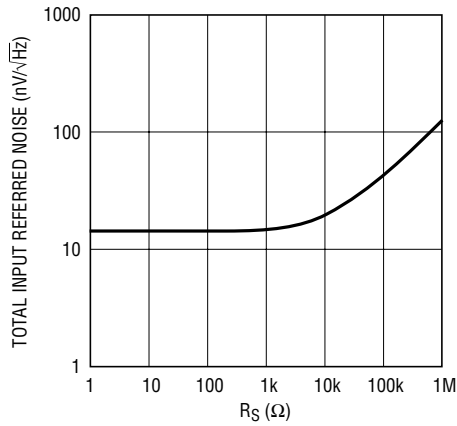

**LT1881 Overshoot vs Capacitive Load**

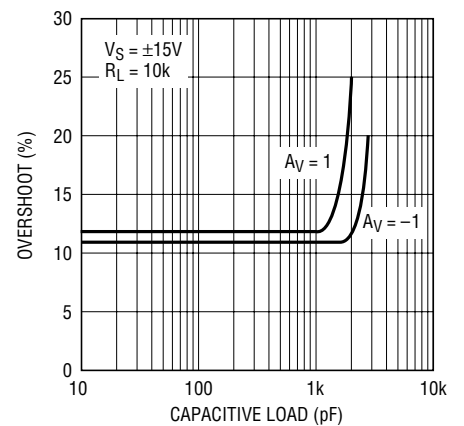

**LT1881 Series Output Resistance vs Capacitive Load**

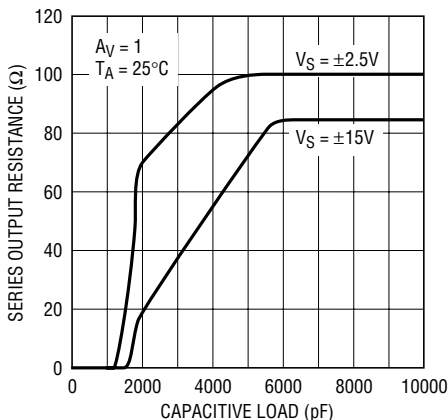

**LT1881 Undistorted Output Swing vs Frequency**

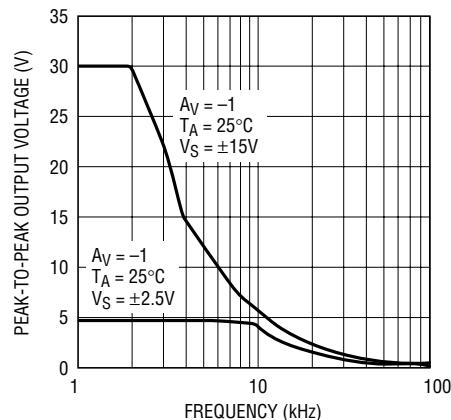

**LT1881 THD + Noise vs Frequency**

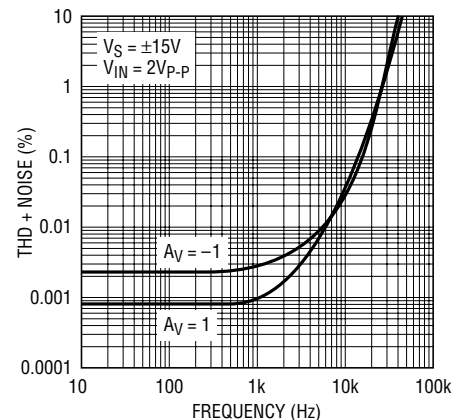

# LT1881/LT1882

## TYPICAL PERFORMANCE CHARACTERISTICS

**LT1881 Total Harmonic Distortion + Noise vs Output Voltage Amplitude**

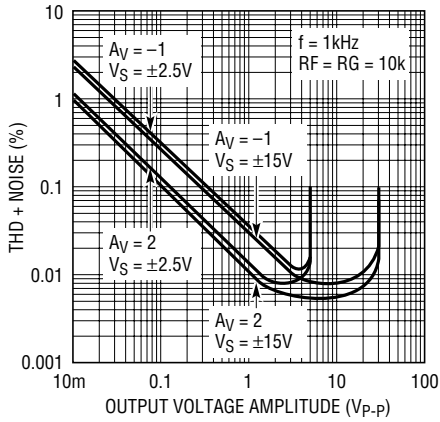

**LT1881 Open-Loop Gain**

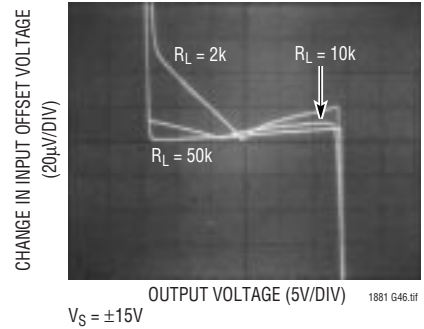

**LT1881 Settling Time/ Output Step 0.01%**

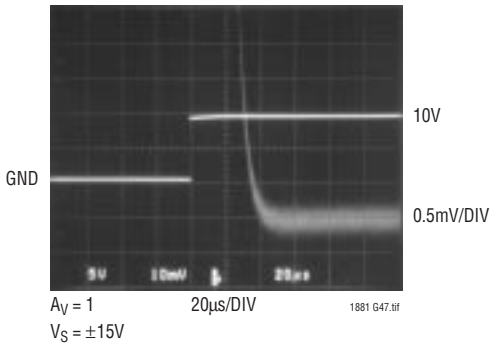

**LT1881 Settling Time/ Output Step 0.01%**

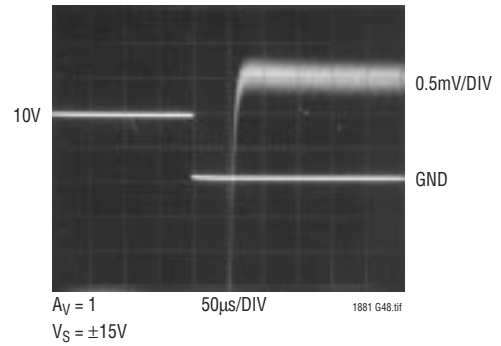

**LT1881 Gain vs Temperature**

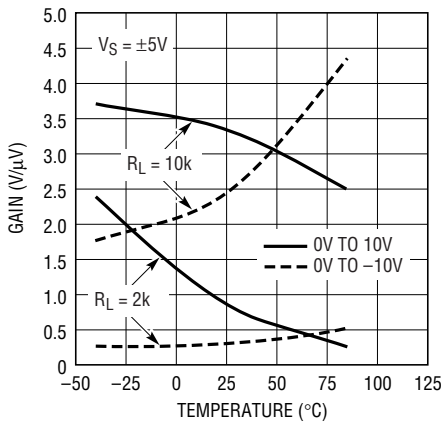

**LT1881 Gain vs Load Resistance**

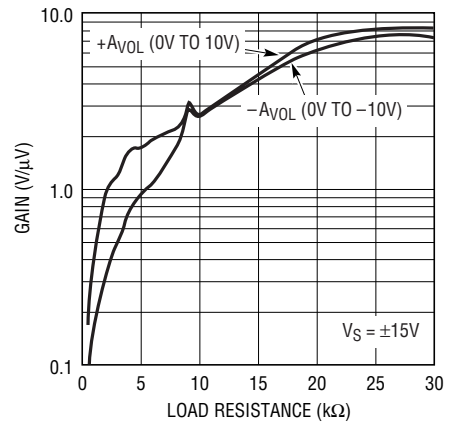

## APPLICATIONS INFORMATION

The LT1881 dual and LT1882 quad op amps feature exceptional input precision with rail-to-rail output swing. The amplifiers are similar to the LT1884 and LT1885 devices. The LT1881 and LT1882 offer superior capacitive load driving capabilities over the LT1884 and LT1885 in low voltage gain configurations. Offset voltages are trimmed to less than  $50\mu\text{V}$  and input bias currents are less than  $200\text{pA}$  on the “A” grade devices. Obtaining beneficial advantage of these precision input characteristics depends upon proper applications circuit design and board layout.

### Preserving Input Precision

Preserving the input voltage accuracy of the LT1881/LT1882 requires that the applications circuit and PC board layout do not introduce errors comparable to or greater than the  $30\mu\text{V}$  offset. Temperature differentials across the input connections can generate thermocouple voltages of  $10$ 's of microvolts. PC board layouts should keep connections to the amplifier's input pins close together and away from heat dissipating components. Air currents across the board can also generate temperature differentials.

The extremely low input bias currents,  $150\text{pA}$ , allow high accuracy to be maintained with high impedance sources and feedback networks. The LT1881/LT1882's low input bias currents are obtained by using a cancellation circuit on-chip. This causes the resulting  $I_{\text{BIAS}+}$  and  $I_{\text{BIAS}-}$  to be uncorrelated, as implied by the  $I_{\text{OS}}$  specification being greater than the  $I_{\text{BIAS}}$ . The user should not try to balance the input resistances in each input lead, as is commonly recommended with most amplifiers. The impedance at either input should be kept as small as possible to minimize total circuit error.

PC board layout is important to insure that leakage currents do not corrupt the low  $I_{\text{BIAS}}$  of the amplifier. In high precision, high impedance circuits, the input pins should be surrounded by a guard ring of PC board interconnect, with the guard driven to the same common mode voltage as the amplifier inputs.

### Input Common Mode Range

The LT1881 and LT1882 outputs are able to swing nearly to each power supply rail, but the input stage is limited to operating between  $V^- + 0.8\text{V}$  and  $V^+ - 0.9\text{V}$ . Exceeding this common mode range will cause the gain to drop to zero; however, no gain reversal will occur.

### Input Protection

The inverting and noninverting input pins of the LT1881 and LT1882 have limited on-chip protection. ESD protection is provided to prevent damage during handling. The input transistors have voltage clamping and limiting resistors to protect against input differentials up to  $10\text{V}$ . Short transients above this level will also be tolerated. If the input pins can see a sustained differential voltage above  $10\text{V}$ , external limiting resistors should be used to prevent damage to the amplifier. A  $1\text{k}$  resistor in each input lead will provide protection against a  $30\text{V}$  differential voltage.

### Capacitive Loads

The LT1881 and LT1882 can drive capacitive loads up to  $1000\text{pF}$  in unity-gain. The capacitive load driving increases as the amplifier is used in higher gain configurations. Capacitive load driving may be increased by decoupling the capacitance from the output with a small resistance.

# LT1881/LT1882

## PACKAGE DESCRIPTION

Dimensions in inches (millimeters) unless otherwise noted.

### N8 Package 8-Lead PDIP (Narrow 0.300) (LTC DWG # 05-08-1510)

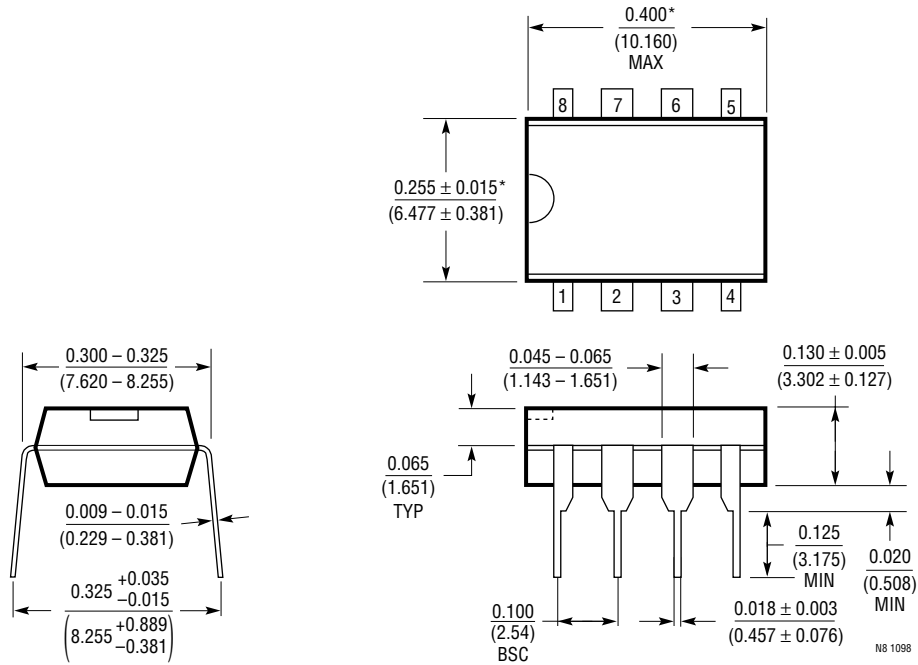

\*THESE DIMENSIONS DO NOT INCLUDE MOLD FLASH OR PROTRUSIONS.  
MOLD FLASH OR PROTRUSIONS SHALL NOT EXCEED 0.010 INCH (0.254mm)

N8 1098

**PACKAGE DESCRIPTION**

Dimensions in inches (millimeters) unless otherwise noted.

**S8 Package**  
**8-Lead Plastic Small Outline (Narrow 0.150)**  
 (LTC DWG # 05-08-1610)

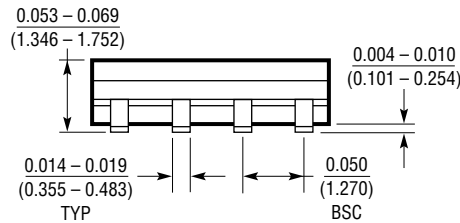
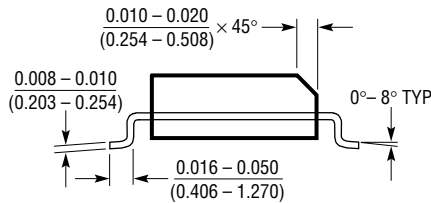
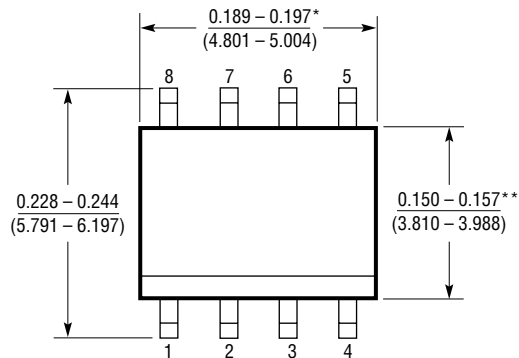

\*DIMENSION DOES NOT INCLUDE MOLD FLASH. MOLD FLASH SHALL NOT EXCEED 0.006" (0.152mm) PER SIDE

\*\*DIMENSION DOES NOT INCLUDE INTERLEAD FLASH. INTERLEAD FLASH SHALL NOT EXCEED 0.010" (0.254mm) PER SIDE

S08 1298

**S Package**  
**14-Lead Plastic Small Outline (Narrow 0.150)**  
 (LTC DWG # 05-08-1610)

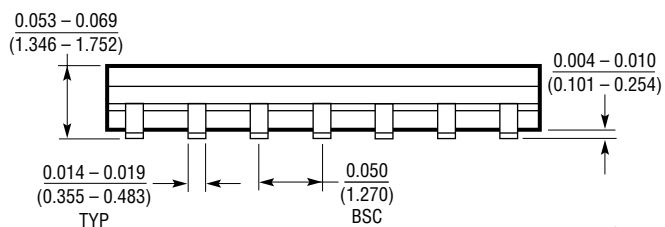
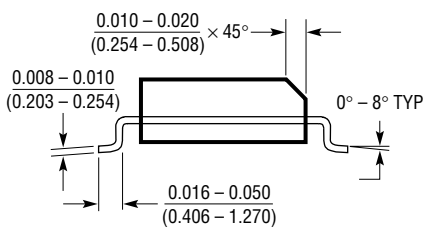
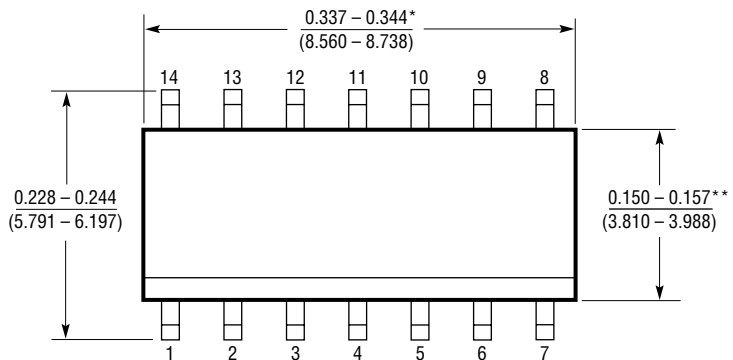

\*DIMENSION DOES NOT INCLUDE MOLD FLASH. MOLD FLASH SHALL NOT EXCEED 0.006" (0.152mm) PER SIDE

\*\*DIMENSION DOES NOT INCLUDE INTERLEAD FLASH. INTERLEAD FLASH SHALL NOT EXCEED 0.010" (0.254mm) PER SIDE

S14 1298

# LT1881/LT1882

## TYPICAL APPLICATION

-50°C to 600°C Digital Thermometer Operates on 3.3V

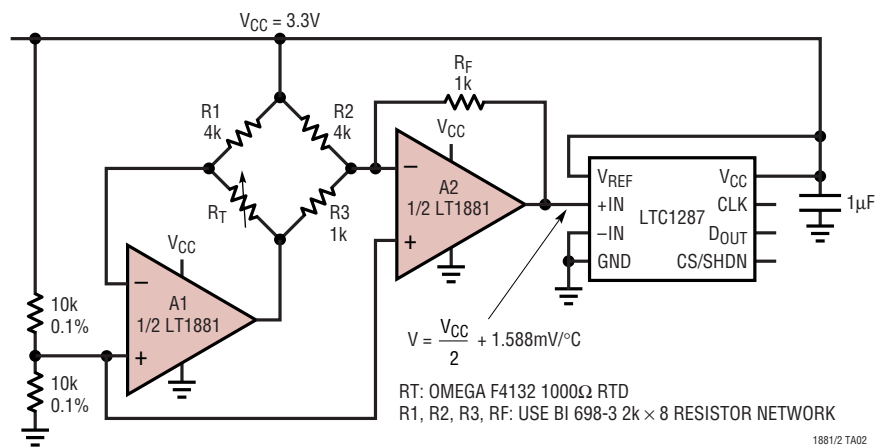

## RELATED PARTS

PART NUMBER	DESCRIPTION	COMMENTS
LT1112/LT1114	Dual/Quad Picoamp Input Op Amp	$V_{OS} = 60\mu\text{V}$ Max
LT1167	Gain Programmable Instrumentation Amp	Gain Error = 0.08% Max
LT1677	Low Noise, Rail-to-Rail Precision Op Amp	$e_n = 3.2\text{nV}/\sqrt{\text{Hz}}$
LT1793	Low Noise JFET Op Amp	$I_B = 10\text{pA}$ Max
LT1880	SOT-23 Picoamp Input Precision Op Amp	$150\mu\text{V}$ Max $V_{OS}$ , -40°C to 85°C Operation Guaranteed, SOT-23 Package
LT1884/LT1885	Dual/Quad Picoamp Input Op Amp	3 Times Faster than LT1881/LT1882
LTC2050	Zero Drift Op Amp in SOT-23	$V_{OS} = 3\mu\text{V}$ Max, Rail-to-Rail Output