

MAXIM

MAX9770 Evaluation Kit

General Description

The MAX9770 evaluation kit (EV kit) is a fully assembled and tested circuit board that uses the MAX9770, a low-EMI, filterless class D, bridge-tied-load (BTL) speaker amplifier with an 80mW stereo DirectDrive™ headphone amplifier. Designed to operate from a 2.5V to 5.5V power supply, the EV kit is capable of delivering 1.2W into an 8Ω load with efficiency up to 85%.

Ordering Information

PART	TEMP RANGE	IC PACKAGE
MAX9770EVKIT	0°C to +70°C	28 TQFN*

*Package code is T2855N-1.

Features

- ◆ Filterless Operation Class D Amplifier Passes FCC Class B Radiated Emissions
- ◆ 2.5V to 5.5V Single-Supply Operation
- ◆ 0.1μA (typ) IC Shutdown Current
- ◆ Drives 1.2W into 8Ω Speaker
- ◆ Drives 80mW into 16Ω Headphone
- ◆ Low 0.015% THD+N
- ◆ Selectable Gain Options
- ◆ Selectable 3-Way Input Mixer/Multiplexer
- ◆ Selectable Switching Frequency
- ◆ Also Evaluates MAX9771
- ◆ Surface-Mount Construction
- ◆ Fully Assembled and Tested

Component List

DESIGNATION	QTY	DESCRIPTION
C1	1	10μF ±20%, 6.3V X5R ceramic capacitor (0805) Taiyo Yuden JMK212BJ106MG or TDK C2012X5R0J106M
C2, C4-C7	5	1μF ±10%, 10V X7R ceramic capacitors (0603) TDK C1608X7R1A105K
C3	1	0.047μF ±10%, 25V X7R ceramic capacitor (0603) TDK C1608X7R1E473K
C8-C11	4	0.47μF ±10%, 10V X5R ceramic capacitors (0603) Taiyo Yuden LMK107BJ474KA or TDK C1608X5R1A474K
C12	1	0.1μF ±10%, 25V X7R ceramic capacitor (0603) Murata GRM188R71E104J or TDK C1608X7R1E104K
C13	1	100pF ±5%, 50V C0G ceramic capacitor (0402) Murata GRP1555C1H101J or Taiyo Yuden UMK105CG101JW

DESIGNATION	QTY	DESCRIPTION
C14, C15, C20	0	Not installed, ceramic capacitors (0402)
C16-C19, C21, C22	0	Not installed, ceramic capacitors (0603)
L1, L2	0	Not installed, power inductors
J1	1	3.5mm surface-mount stereo headphone jack
JU1-JU6	6	3-pin headers
JU7	1	5-pin header
JU8	1	2-pin header
OUT+, OUT-, FOUT1+, FOUT1-, HPOUTR, HPOUTL, TP1	0	Not installed, test points
R1	1	49.9Ω ±1% resistor (0402)
R2, R3	0	Not installed, resistors (0603)
T1	0	Not installed, common-mode choke
U1	1	MAX9770ETI (28-pin 5mm x 5mm thin QFN)
None	8	Shunts
None	1	MAX9770/MAX9771 PC board

Evaluates: MAX9770/MAX9771



MAX9770 Evaluation Kit

Component Suppliers

SUPPLIER	PHONE	FAX	WEBSITE
Murata	770-436-1300	770-436-3030	www.murata.com
Taiyo Yuden	800-348-2496	847-925-0899	www.t-yuden.com
TDK	847-803-6100	847-390-4405	www.component.tdk.com

Note: Indicate that you are using the MAX9770 when contacting these component suppliers.

Quick Start

The MAX9770 EV kit is fully assembled and tested. Follow the steps listed below to verify board operation. **Do not turn on the power supply until all connections are completed.**

Recommended Equipment

- 2.5V to 5.5V, 1A power supply (suggested supply of 3.3V)
- Audio source (i.e., CD player, cassette player, etc.)
- 8Ω speaker
- Stereo headphone with 3.5mm plug

Procedure

- 1) Install shunts across jumpers JU1 (pins 1 and 2, GAIN1 = high) and JU2 (pins 2 and 3, GAIN2 = low) (speaker gain = 9dB, headphone gain = -2dB).
- 2) Install shunts across jumpers JU3 (pins 1 and 2, SEL1 = high), JU4 (pins 2 and 3, SEL2 = low), and JU5 (pins 2 and 3, SELM = low) (stereo inputs VRIN1 and VLIN1 are enabled).
- 3) Install a shunt across pins 1 and 2 of jumper JU6 (the EV kit is enabled).
- 4) Install a shunt across pins 1 and 4 of jumper JU7 (SYNC = high, spread-spectrum mode).
- 5) Install a shunt across jumper JU8 (automatic switchover to headphone operation is enabled).
- 6) Connect the speaker across the OUT+ and OUT- test points.

- 7) Connect the positive terminal of the power supply to the VDD pad and the power-supply ground terminal to the GND pad.
- 8) Connect the audio source to VRIN1 and VLIN1.
- 9) Turn on the power supply.
- 10) Turn on the audio source.
- 11) Plug the headphone into J1 for headphone mode.

Detailed Description

The MAX9770 EV kit features the MAX9770 low-EMI filterless class D amplifier IC, designed to drive a BTL mono speaker or a stereo headphone with an AC stereo/mono input source in portable audio applications. The EV kit operates from a DC power supply that can provide 2.5V to 5.5V and 1A of current. The EV kit accepts only a single-ended audio input. The audio input source is amplified to drive 1.2W into an 8Ω speaker.

The MAX9770 is designed to pass FCC class B emissions without additional filtering when using 10cm of cable to connect the speaker. In applications where more margin and/or cable length are required, output capacitors C14, C15, and common-mode choke T1 can be added to reduce radiated emission. Connect the speaker to FOUT1+/FOUT1- test points. Table 1 lists the cable length vs. the required output components. The filtered outputs (FOUT2+, FOUT2-) require installation of filtering components L1, L2, C16-C19, C21, R2, and R3.

Table 1. Cable Length vs. Suggested Output Components

CABLE LENGTH X (cm)	OUTPUT CAPACITORS C14 AND C15	COMMON-MODE CHOKE T1	LCR FILTER L1, L2, C16-C19, C21, R2, R3	OUTPUT SPEAKER CONNECTED BETWEEN
X < 10	—	—	—	OUT+, OUT-
10 < X < 15	Required (100pF)	—	—	OUT+, OUT-
15 < X < 30	Required (100pF)	Required	—	FOUT1+, FOUT1-
X > 30	—	—	Required	FOUT2+, FOUT2-

MAX9770 Evaluation Kit

Evaluates: MAX9770/MAX9771

The EV kit outputs (OUT+, OUT-) can be connected directly to a speaker load without any filtering. However, a filter can be added to ease evaluation by recovering the audio signal. See Table 2 for the recommended filtering component values for an 8Ω load and 30kHz cutoff frequency.

Jumper Selection

Output Gain Selection

Jumpers JU1 and JU2 control the GAIN1 and GAIN2 pins of the MAX9770 IC. The MAX9770 can be configured to automatically switch between two gain settings depending on whether the EV kit is in speaker or headphone mode. By driving one or both gain inputs with the HPS pin, the gain of the output changes when a headphone is inserted/removed. See Table 3 for output gain settings.

Table 2. Recommended Filtering Components for Outputs with 8Ω Load

COMPONENT	RECOMMENDED VALUE
L1, L2	15μH
C16, C17	0.033μF
C18, C19	0.068μF
C21	0.15μF
R2, R3	22Ω

Table 3. JU1 and JU2 Jumpers Selection

SPEAKER MODE GAIN (HPS = 0) (dB)	HEADPHONE MODE GAIN (HPS = 1) (dB)	JU1 SHUNT POSITION	GAIN1 PIN	JU2 SHUNT POSITION	GAIN2 PIN
6	-2	Open	GAIN1 = HPS, connect pin 2 of JU1 to pin 1 of JU8	Pins 2 and 3	GAIN2 = low
3	1	Open	GAIN1 = HPS, connect pin 2 of JU1 to pin 1 of JU8	Pins 1 and 2	GAIN2 = high
6	4	Pins 2 and 3	GAIN1 = low	Open	GAIN2 = HPS, connect pin 2 of JU2 to pin 1 of JU8
9	1	Pins 1 and 2	GAIN1 = high	Open	GAIN2 = HPS, connect pin 2 of JU2 to pin 1 of JU8
6	1	Open	GAIN1 = HPS, connect pin 2 of JU1 to pin 1 of JU8	Open	GAIN2 = HPS, connect pin 2 of JU2 to pin 1 of JU8
0	1	Pins 1 and 2	GAIN1 = high	Pins 1 and 2	GAIN2 = high
9 (default)	-2 (default)	Pins 1 and 2	GAIN1 = high	Pins 2 and 3	GAIN2 = low
3	4	Pins 2 and 3	GAIN1 = low	Pins 1 and 2	GAIN2 = high
6	7	Pins 2 and 3	GAIN1 = low	Pins 2 and 3	GAIN2 = low

Note: JU8 is closed.

MAX9770 Evaluation Kit

Input Selection

Jumpers JU3, JU4, and JU5 control the SEL1, SEL2, and SELM pins of the MAX9770 IC.

See Table 4 for JU3, JU4, and JU5 functions.

Table 4. JU3, JU4, and JU5 Jumpers Selection

JU3 SHUNT POSITION	JU4 SHUNT POSITION	JU5 SHUNT POSITION	INPUT SELECTION
Pins 2 and 3 (SEL1 = low)	Pins 2 and 3 (SEL2 = low)	Pins 2 and 3 (SELM = low)	All inputs are disabled
Pins 2 and 3 (SEL1 = low)	Pins 2 and 3 (SEL2 = low)	Pins 1 and 2 (SELM = high)	VMONO (mono)
Pins 2 and 3 (SEL1 = low)	Pins 1 and 2 (SEL2 = high)	Pins 2 and 3 (SELM = low)	VRIN2/VLIN2 (stereo)
Pins 2 and 3 (SEL1 = low)	Pins 1 and 2 (SEL2 = high)	Pins 1 and 2 (SELM = high)	VRIN2/VLIN2 (stereo), VMONO (mono)
Pins 1 and 2 (SEL1 = high)	Pins 2 and 3 (SEL2 = low)	Pins 2 and 3 (SELM = low)	VRIN1/VLIN1 (stereo) (default)
Pins 1 and 2 (SEL1 = high)	Pins 2 and 3 (SEL2 = low)	Pins 1 and 2 (SELM = high)	VRIN1/VLIN1 (stereo), VMONO (mono)
Pins 1 and 2 (SEL1 = high)	Pins 1 and 2 (SEL2 = high)	Pins 2 and 3 (SELM = low)	VRIN1/VLIN1 (stereo), VRIN2/VLIN2 (stereo)
Pins 1 and 2 (SEL1 = high)	Pins 1 and 2 (SEL2 = high)	Pins 1 and 2 (SELM = high)	VRIN1/VLIN1 (stereo), VRIN2/VLIN2 (stereo), VMONO (mono)

Note: Refer to Table 2 of the MAX9770 IC data sheet for the multiplex/mixer settings.

Shutdown Mode ($\overline{\text{SHDN}}$)

Jumper JU6 controls the shutdown pin ($\overline{\text{SHDN}}$) of the MAX9770 IC. See Table 5 for shunt positions.

Table 5. JU6 Jumper Selection

SHUNT POSITION	$\overline{\text{SHDN}}$ PIN	EV KIT FUNCTION
Pins 1 and 2 (default)	Connected to VDD	EV kit enabled
Pins 2 and 3	Connected to GND	Shutdown mode

Switching Frequency Mode (SYNC)

Jumper JU7 provides an option to select the switching frequency of the MAX9770 IC. See Table 6 for the various shunt positions.

Table 6. JU7 Jumper Selection

SHUNT POSITION	SYNC PIN	INTERNAL OSCILLATOR SWITCHING FREQUENCY
Pins 1 and 2	SYNC = low	1.1MHz
Pins 1 and 3	SYNC = floating	1.45MHz
Pins 1 and 4 (default)	SYNC = high	1.22MHz \pm 120kHz (spread-spectrum mode)
Pins 1 and 5	SYNC = external clock input	Synchronized to the incoming clock frequency

MAX9770 Evaluation Kit

Evaluates: MAX9770/MAX9771

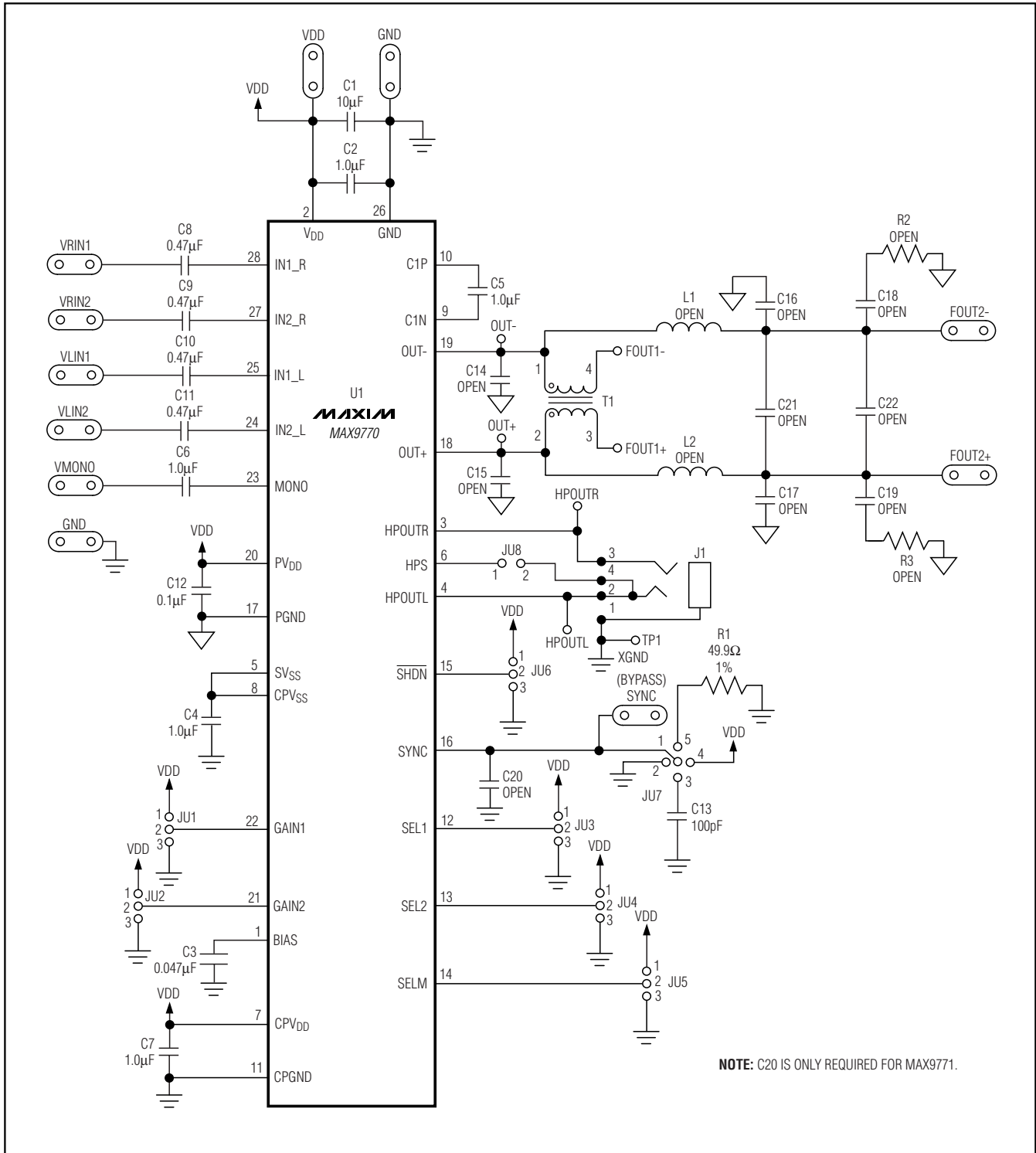

Figure 1. MAX9770 EV Kit Schematic

MAX9770 Evaluation Kit

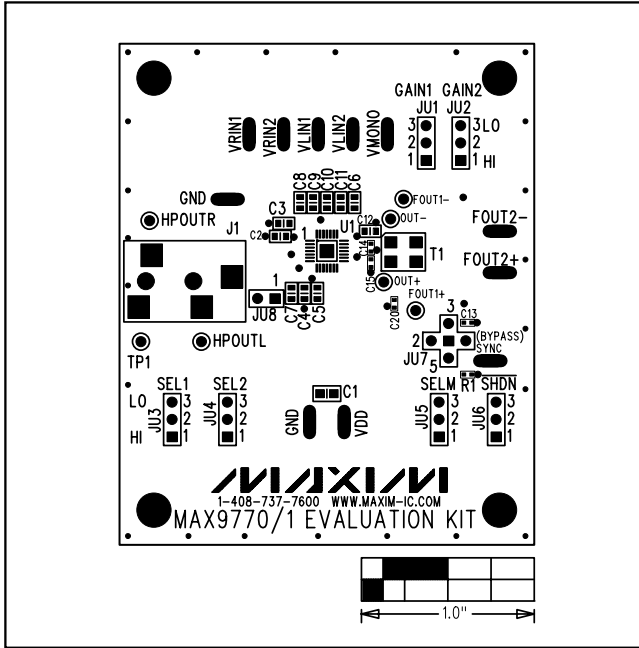

Figure 2. MAX9770 EV Kit Component Placement Guide—Component Side

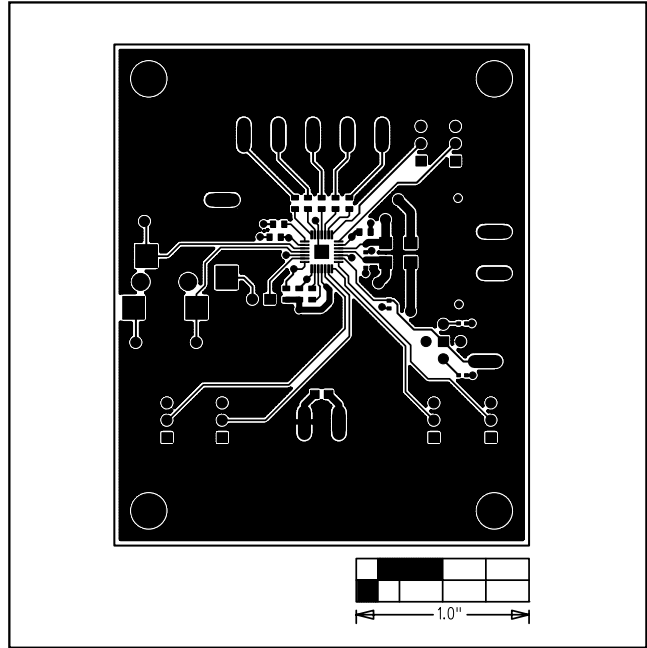

Figure 3. MAX9770 EV Kit PC Board Layout—Component Side

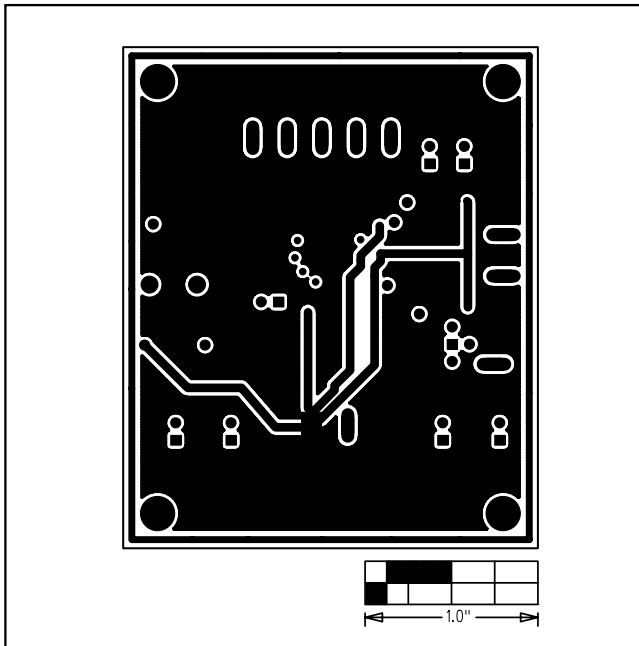

Figure 4. MAX9770 EV Kit PC Board Layout—Layer 2 (GND)

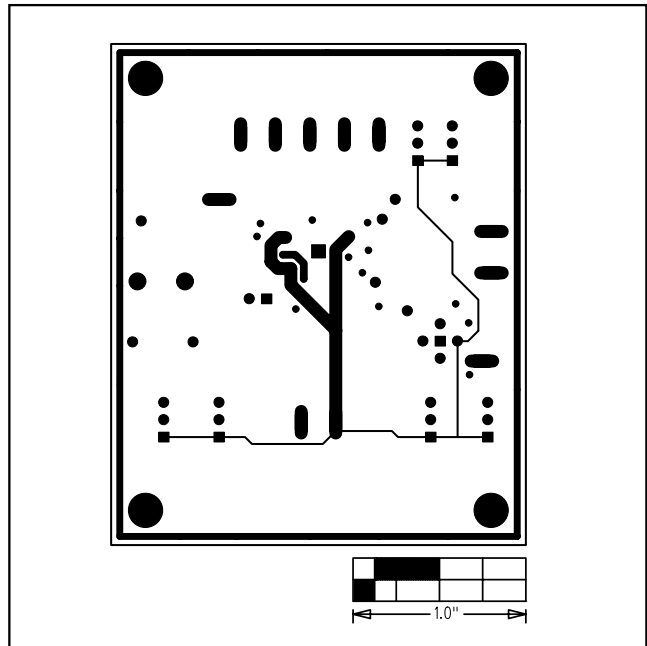

Figure 5. MAX9770 EV Kit PC Board Layout—Layer 3 (VDD)

MAX9770 Evaluation Kit

Evaluates: MAX9770/MAX9771

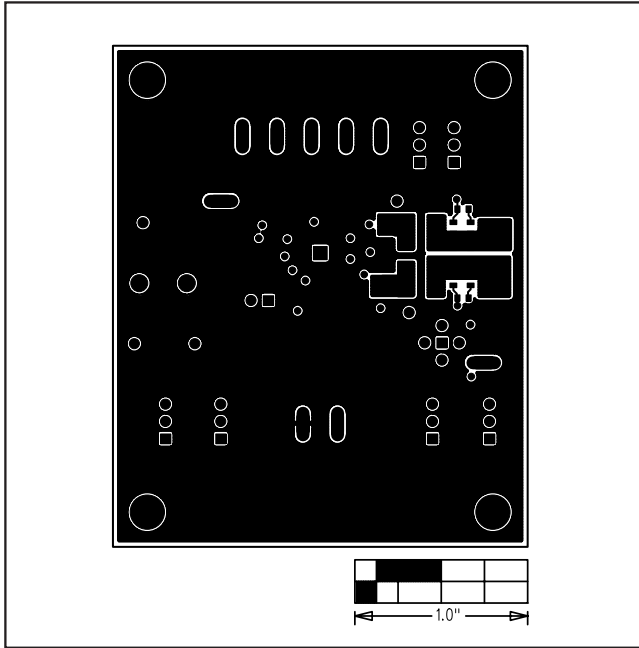

Figure 6. MAX9770 EV Kit PC Board Layout—Solder Side

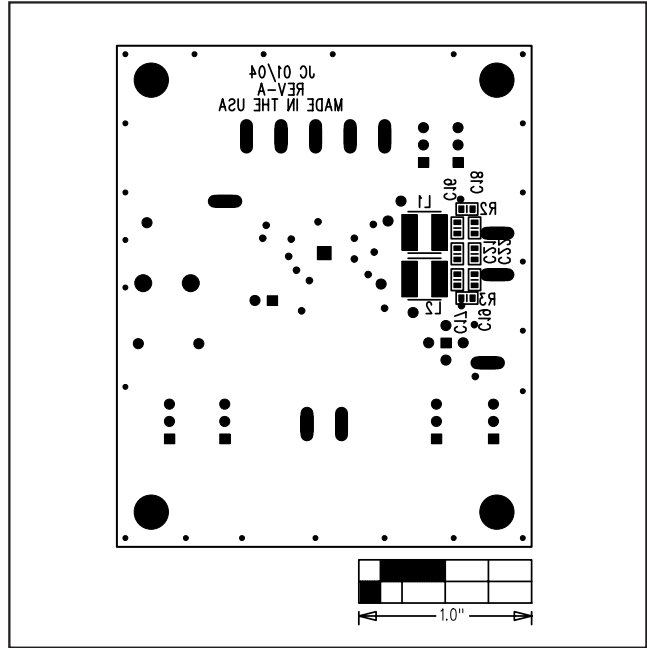

Figure 7. MAX9770 EV Kit Component Placement Guide—Solder Side

Maxim cannot assume responsibility for use of any circuitry other than circuitry entirely embodied in a Maxim product. No circuit patent licenses are implied. Maxim reserves the right to change the circuitry and specifications without notice at any time.

Maxim Integrated Products, 120 San Gabriel Drive, Sunnyvale, CA 94086 408-737-7600 _____ 7