

MAXIM

Single/Dual/Quad, General-Purpose, Low-Voltage, Rail-to-Rail Output Op Amps

General Description

The LMX321/LMX358/LMX324 are single/dual/quad, low-cost, low-voltage, pin-to-pin compatible upgrades to the LMV321/LMV358/LMV324 family of general purpose op amps. These devices offer Rail-to-Rail® outputs and an input common-mode range that extends below ground. These op amps draw only 105µA of quiescent current per amplifier, operate from a single +2.3V to +7V supply, and drive 2kΩ resistive loads to within 40mV of either rail. The LMX321/LMX358/LMX324 are unity-gain stable with a 1.3MHz gain-bandwidth product capable of driving capacitive loads up to 400pF. The combination of low voltage, low cost, and small package size makes these amplifiers ideal for portable/battery-powered equipment.

The LMX321 single op amp is available in ultra-small 5-pin SC70 and space-saving 5-pin SOT23 packages. The LMX358 dual op amp is available in the tiny 8-pin SOT23 package. The LMX324 quad op amp is available in 14-pin TSSOP and SO packages.

Applications

- Cellular Phones
- Laptops
- Low-Power, Low-Voltage Applications
- Portable/Battery-Powered Equipment
- Cordless Phones
- Active Filters

Features

- ◆ Upgrade to LMV321/LMV358/LMV324 Family
- ◆ Single +2.3V to +7V Supply Voltage Range
- ◆ Available in Space-Saving Packages
 - 5-Pin SC70 (LMX321)
 - 8-Pin SOT23 (LMX358)
 - 14-Pin TSSOP (LMX324)
- ◆ 1.3MHz Gain-Bandwidth Product
- ◆ 105µA Quiescent Current per Amplifier (VCC = +2.7V)
- ◆ No Phase Reversal for Overdriven Inputs
- ◆ No Crossover Distortion
- ◆ Rail-to-Rail Output Swing
- ◆ Input Common-Mode Voltage Range: VEE - 0.2V to VCC - 0.8V
- ◆ Drives 2kΩ Resistive Loads

Ordering Information

PART	TEMP. RANGE	PIN-PACKAGE
LMX321AXK-T	-40°C to +125°C	5 SC70-5
LMX321AUK-T	-40°C to +125°C	5 SOT23-5
LMX358AKA-T	-40°C to +125°C	8 SOT23-8
LMX358ASA	-40°C to +125°C	8 SO
LMX358AUA	-40°C to +125°C	8 µMAX
LMX324ASD	-40°C to +125°C	14 SO
LMX324AUD	-40°C to +125°C	14 TSSOP

Selector Guide appears at end of data sheet.

Pin Configurations

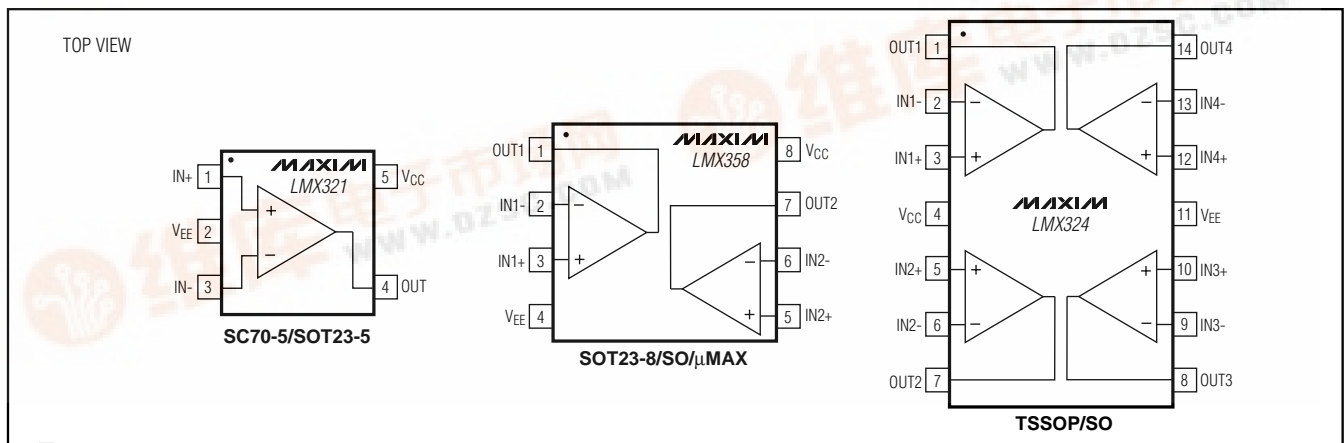

LMX321/LMX358/LMX324



Rail-to-Rail is a registered trademark of Nippon Motorola, Ltd.

Single/Dual/Quad, General-Purpose, Low-Voltage, Rail-to-Rail Output Op Amps

ABSOLUTE MAXIMUM RATINGS

Supply Voltage (V _{CC} to V _{EE})	-0.3V to +8V	8-Pin SO (derate 5.9mW/°C above +70°C)	471mW
Differential Input Voltage (V _{IN+} - V _{IN-})	V _{EE} to V _{CC}	8-Pin μMAX (derate 4.5mW/°C above +70°C)	362mW
OUT_ to V _{EE}	-0.3V to (V _{CC} + 0.3V)	14-Pin TSSOP (derate 9.1mW/°C above +70°C)	727mW
Output Short-Circuit Duration		14-Pin SO (derate 8.3mW/°C above +70°C)	667mW
OUT_ Shorted to V _{CC} or V _{EE}	Continuous	Operating Temperature Range	-40°C to +125°C
Continuous Power Dissipation (T _A = +70°C)		Junction Temperature	+150°C
5-Pin SC70-5 (derate 3.1mW/°C above +70°C)	247mW	Storage Temperature Range	-65°C to +150°C
5-Pin SOT23-5 (derate 7.1mW/°C above +70°C)	571mW	Lead Temperature (soldering, 10s)	+300°C
8-Pin SOT23-8 (derate 7.52mW/°C above +70°C)	602mW		

Stresses beyond those listed under "Absolute Maximum Ratings" may cause permanent damage to the device. These are stress ratings only, and functional operation of the device at these or any other conditions beyond those indicated in the operational sections of the specifications is not implied. Exposure to absolute maximum rating conditions for extended periods may affect device reliability.

ELECTRICAL CHARACTERISTICS

(V_{CC} = +2.7V, V_{EE} = 0, V_{OUT} = V_{CC}/2, V_{CM} = 1V, R_L > 1MΩ, T_A = +25°C, unless otherwise noted.)

PARAMETER	SYMBOL	CONDITIONS	MIN	TYP	MAX	UNITS
DC Characteristics						
Input Offset Voltage	V _{OS}			1	6	mV
Input Offset Voltage Average Drift	TCV _{OS}			6		μV/°C
Input Bias Current	I _B			18	50	nA
Input Offset Current	I _{OS}			1	8	nA
Common-Mode Rejection Ratio	CMRR	-0.2V < V _{CM} < 1.8V	72	92		dB
Power-Supply Rejection Ratio	PSRR	2.3V ≤ V _{CC} ≤ 7V, V _{OUT} = 1V	82	96		dB
Input Common-Mode Voltage Range	V _{CM}	For CMRR ≥ 72dB	Limit	-0.2	1.8	V
			Typ	-0.2	1.9	
Large-Signal Voltage Gain	A _{VOL}	R _L = 2kΩ to V _{EE} , 0.3V < V _{OUT} < 2.4V	20	120		V/mV
Output Voltage Swing	V _{OUT}	R _L = 10kΩ to 1.35V	V _{CC} - V _{OH}	12	50	mV
			V _{OL}	10	40	
		R _L = 2kΩ to 1.35V	V _{CC} - V _{OH}	40	110	
			V _{OL}	25	60	
Supply Current	I _{CC}	LMX321 (Single)		105	150	μA
		LMX358 (Dual)		210	300	
		LMX324 (Quad)		420	600	
AC Characteristics						
Slew Rate	SR	1V step Input		1		V/μs
Gain-Bandwidth Product	GBW	C _L = 200pF		1.3		MHz
Phase Margin	φ _M			64		degrees
Gain Margin	GM			24		dB
Input Noise Voltage Density	e _n	f = 1kHz		66		nV/√Hz
Input Current Noise Density	i _n	f = 1kHz		0.13		pA/√Hz

Single/Dual/Quad, General-Purpose, Low-Voltage, Rail-to-Rail Output Op Amps

LMX321/LMX358/LMX324

ELECTRICAL CHARACTERISTICS

($V_{CC} = +2.7V$, $V_{EE} = 0$, $V_{OUT} = V_{CC}/2$, $V_{CM} = 1V$, $R_L > 1M\Omega$, $T_A = -40^{\circ}C$ to $+125^{\circ}C$, unless otherwise noted.) (Note 1)

PARAMETER	SYMBOL	CONDITIONS	MIN	TYP	MAX	UNITS
DC Characteristics						
Input Offset Voltage	V_{OS}				9	mV
Input Bias Current	I_B				70	nA
Input Offset Current	I_{OS}				15	nA
Common-Mode Rejection Ratio	CMRR	$-0.1 < V_{CM} < 1.7V$	60			dB
Power-Supply Rejection Ratio	PSRR	$2.3V \leq V_{CC} \leq 7V$, $V_{OUT} = 1V$	75			dB
Input Common-Mode Voltage Range	V_{CM}	For CMRR $\geq 60dB$	Limit	-0.1	1.7	V
			Typ	-0.1	1.8	
Large-Signal Voltage Gain	A_{VOL}	$R_L = 2k\Omega$ to V_{EE} , $0.3V \leq V_{OUT} \leq 2.4V$	10			V/mV
Output Voltage Swing	V_{OUT}	$R_L = 10k\Omega$ to 1.55V	$V_{CC} - V_{OH}$		130	mV
			V_{OL}		50	
		$R_L = 2k\Omega$ to 1.35V	$V_{CC} - V_{OH}$		150	
			V_{OL}		70	
Supply Current	I_{CC}	LMX321 (Single)			180	μA
		LMX358 (Dual)			360	
		LMX324 (Quad)			720	

ELECTRICAL CHARACTERISTICS

($V_{CC} = +5V$, $V_{EE} = 0$, $V_{OUT} = V_{CC}/2$, $V_{CM} = 2V$, $R_L > 1M\Omega$, $T_A = +25^{\circ}C$, unless otherwise noted.)

PARAMETER	SYMBOL	CONDITIONS	MIN	TYP	MAX	UNITS
DC Characteristics						
Input Offset Voltage	V_{OS}			1	6	mV
Input Offset Voltage Average Drift	TCV_{OS}			6		$\mu V/^{\circ}C$
Input Bias Current	I_B			18	50	nA
Input Offset Current	I_{OS}			1	8	nA
Common-Mode Rejection Ratio	CMRR	$-0.2 < V_{CM} < 4.1V$	72	92		dB
Power-Supply Rejection Ratio	PSRR	$2.3V \leq V_{CC} \leq 7V$, $V_{OUT} = 1V$, $V_{CM} = 1V$	82	96		dB
Input Common-Mode Voltage Range	V_{CM}	For CMRR $\geq 72dB$	Limit	-0.2	4.1	V
			Typ	-0.2	4.2	
Large-Signal Voltage Gain	A_{VOL}	$R_L = 2k\Omega$ to V_{EE} , $0.3V \leq V_{OUT} \leq 4.7V$	40	200		V/mV

Single/Dual/Quad, General-Purpose, Low-Voltage, Rail-to-Rail Output Op Amps

ELECTRICAL CHARACTERISTICS (continued)

($V_{CC} = +5V$, $V_{EE} = 0$, $V_{OUT} = V_{CC}/2$, $V_{CM} = 2V$, $R_L > 1M\Omega$, $T_A = +25^\circ C$, unless otherwise noted.)

PARAMETER	SYMBOL	CONDITIONS	MIN	TYP	MAX	UNITS
Output Voltage Swing	V_{OUT}	$R_L = 10k\Omega$ to 2.5V	$V_{CC} - V_{OH}$	20	60	mV
			V_{OL}	12	40	
		$R_L = 2k\Omega$ to 2.5V	$V_{CC} - V_{OH}$	65	130	
			V_{OL}	40	80	
Output Short-Circuit Current	I_{SC}	Sourcing, $V_{OUT} = 0$	5	25	mA	
		Sinking, $V_{OUT} = 5V$	10	28		
Supply Current	I_{CC}	LMX321 (Single)		120	170	μA
		LMX358 (Dual)		240	340	
		LMX324 (Quad)		480	680	
AC Characteristics						
Slew Rate	SR	3V step input		1		V/ μs
Gain-Bandwidth Product	GBW	$C_L = 200pF$		1.3		MHz
Phase Margin	ϕ_M			65		degrees
Gain Margin	GM			25		dB
Input Noise Voltage Density	e_n	$f = 1kHz$		65		nV/ \sqrt{Hz}
Input Noise Current Density	i_n	$f = 1kHz$		0.13		pA/ \sqrt{Hz}

ELECTRICAL CHARACTERISTICS

($V_{CC} = +5V$, $V_{EE} = 0$, $V_{OUT} = V_{CC}/2$, $V_{CM} = 2V$, $R_L > 1M\Omega$, $T_A = -40^\circ C$ to $+125^\circ C$, unless otherwise noted.) (Note 1)

PARAMETER	SYMBOL	CONDITIONS	MIN	TYP	MAX	UNITS
DC Characteristics						
Input Offset Voltage	V_{OS}				9	mV
Input Bias Current	I_B				70	nA
Input Offset Current	I_{OS}				15	nA
Common-Mode Rejection Ratio	CMRR	$-0.1 < V_{CM} < 4.0V$	63			dB
Power-Supply Rejection Ratio	PSRR	$2.3V \leq V_{CC} \leq 7V$, $V_{OUT} = 1V$, $V_{CM} = 1V$	75			dB
Input Common-Mode Voltage Range	V_{CM}	For CMRR $\geq 63dB$	Limit		4.0	V
			Typ	-0.1	4.1	
Large-Signal Voltage Gain	A_{VOL}	$R_L = 2k\Omega$ to V_{EE} , $0.3V \leq V_{OUT} \leq 4.7V$	20			V/mV
Output Voltage Swing	V_{OUT}	$R_L = 10k\Omega$ to 2.5V	$V_{CC} - V_{OH}$		170	mV
			V_{OL}		70	
		$R_L = 2k\Omega$ to 2.5V	$V_{CC} - V_{OH}$		190	
			V_{OL}		90	
Supply Current	I_{CC}	LMX321 (Single)			210	μA
		LMX358 (Dual)			420	
		LMX324 (Quad)			840	

Note 1: Specifications are 100% tested at $T_A = +25^\circ C$ (exceptions noted). All temperature limits are guaranteed by design.

Single/Dual/Quad, General-Purpose, Low-Voltage, Rail-to-Rail Output Op Amps

Typical Operating Characteristics

($T_A = +25^\circ\text{C}$, $V_{EE} = 0$, unless otherwise noted.)

LMX321/LMX358/LMX324

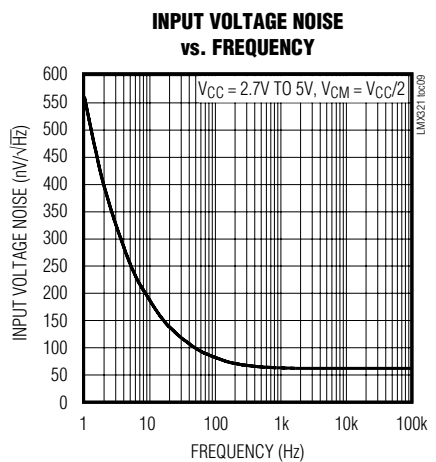
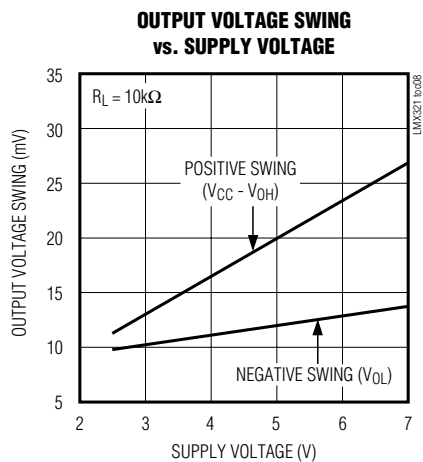
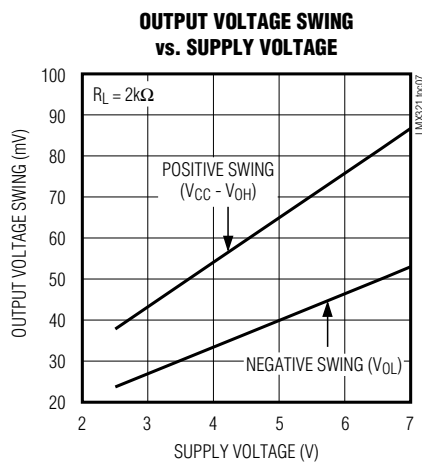
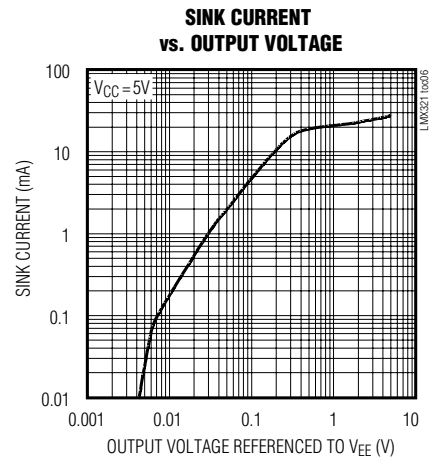
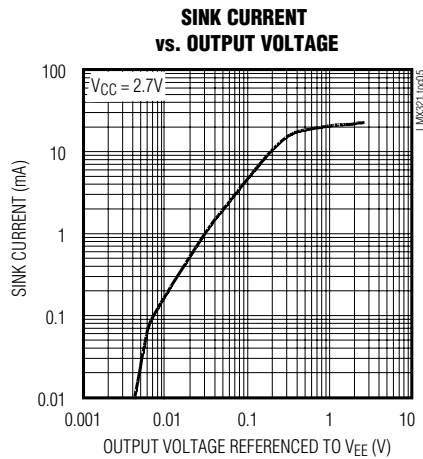
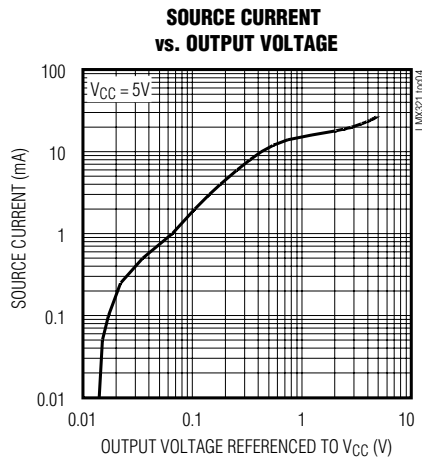
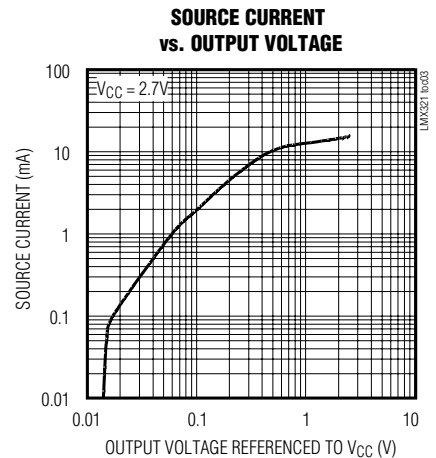
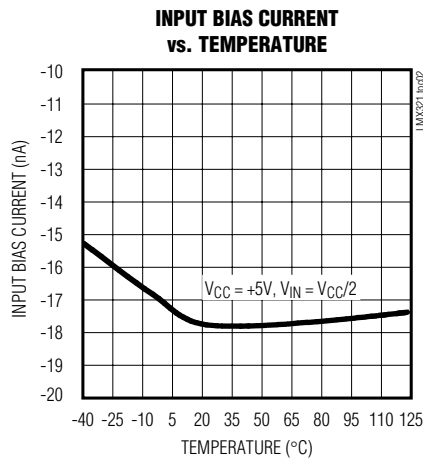
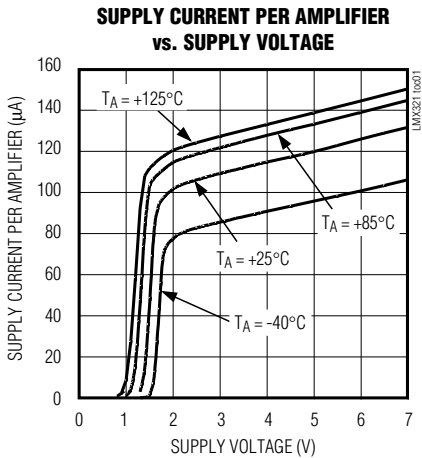

Single/Dual/Quad, General-Purpose, Low-Voltage, Rail-to-Rail Output Op Amps

Typical Operating Characteristics (continued)

($T_A = +25^\circ\text{C}$, $V_{EE} = 0$, unless otherwise noted.)

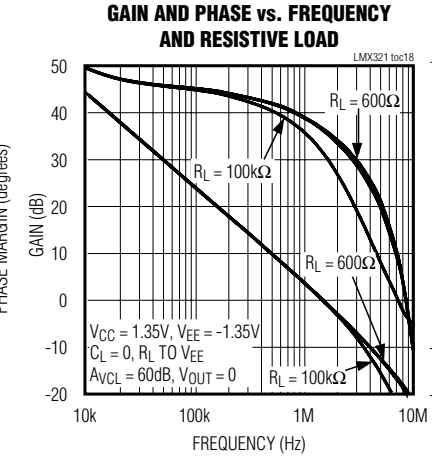
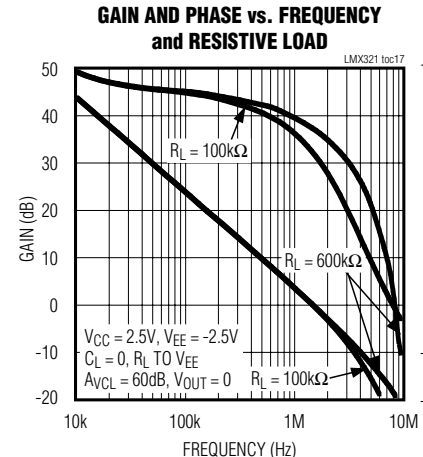
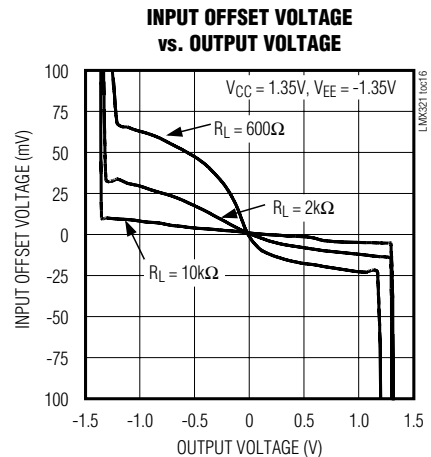
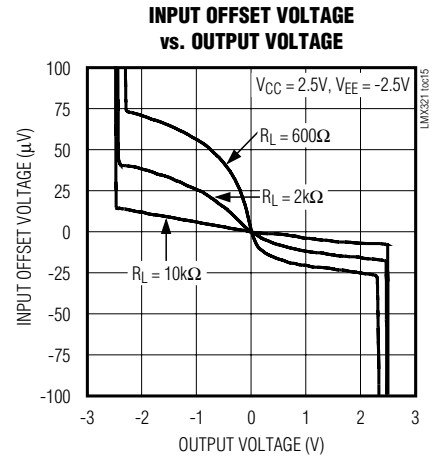
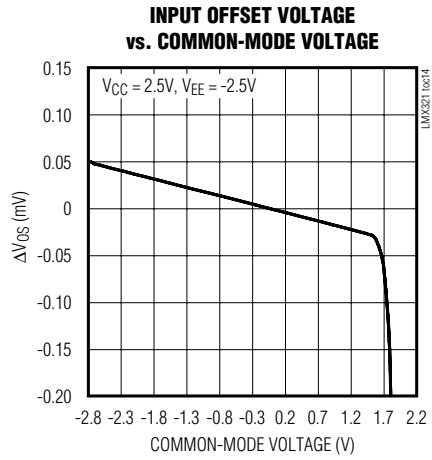
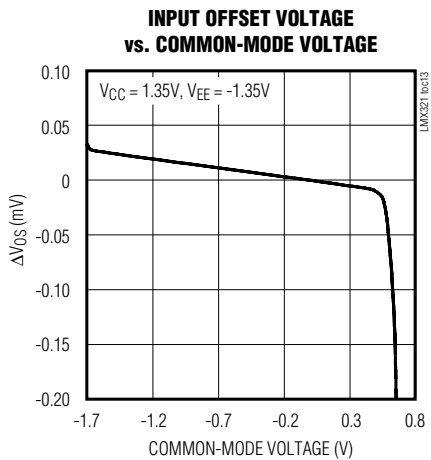
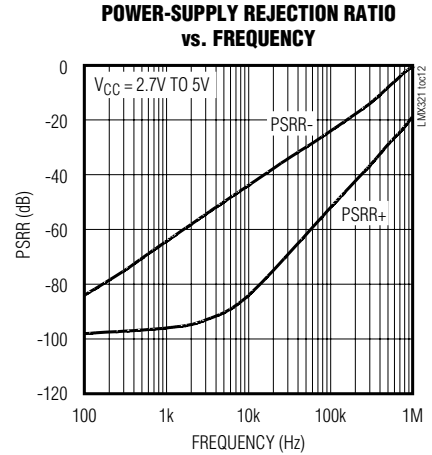
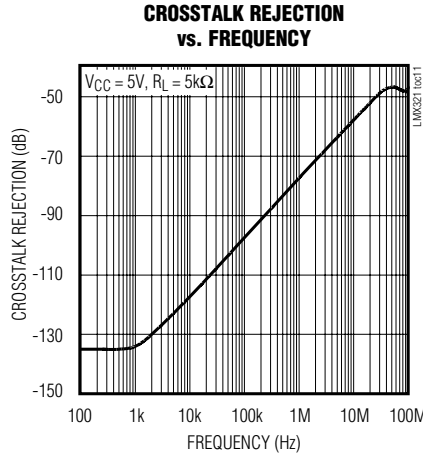
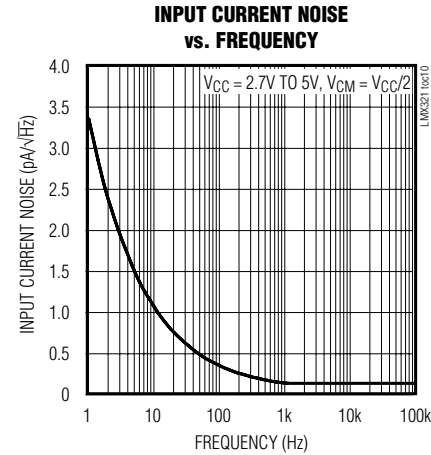

Single/Dual/Quad, General-Purpose, Low-Voltage, Rail-to-Rail Output Op Amps

Typical Operating Characteristics (continued)

($T_A = +25^\circ\text{C}$, $V_{EE} = 0$, unless otherwise noted.)

LMX321/LMX358/LMX324

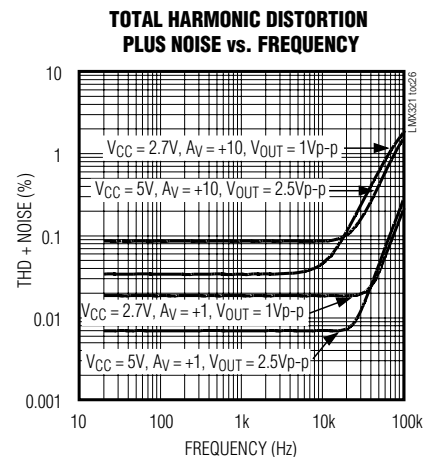
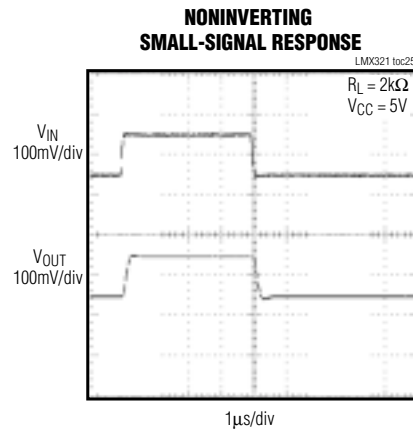
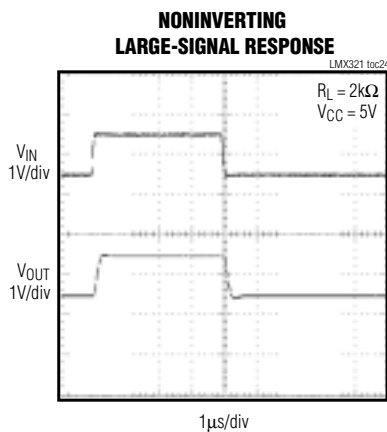
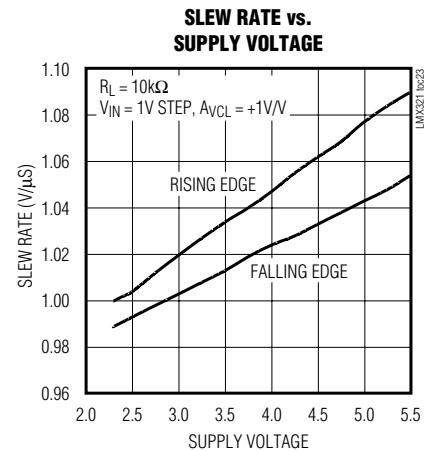
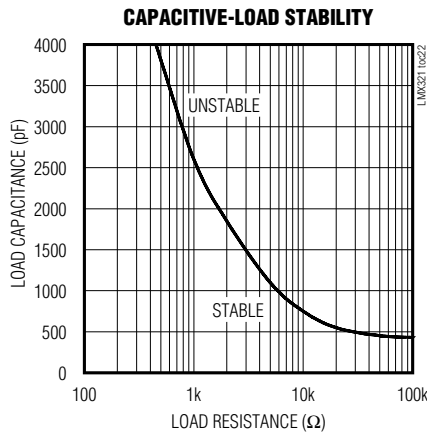
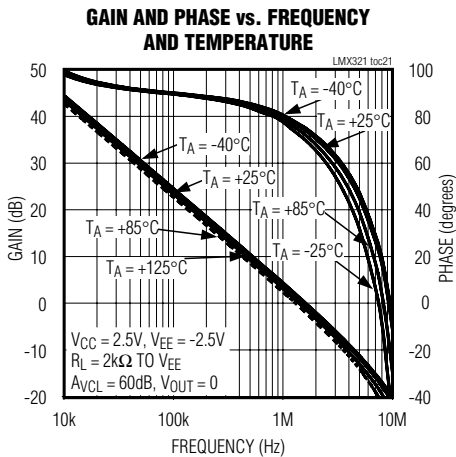
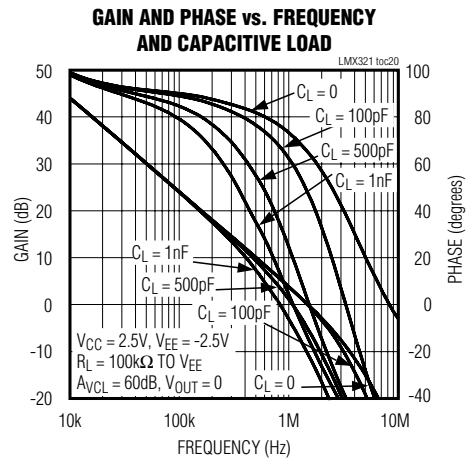
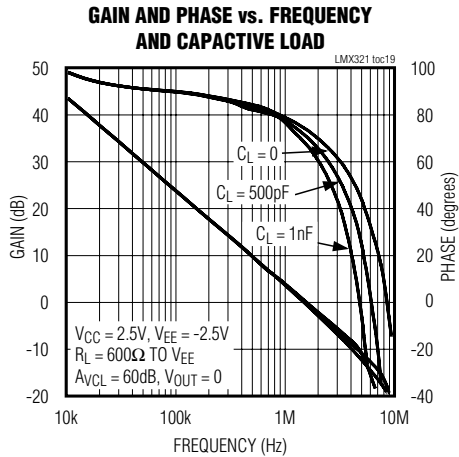

Single/Dual/Quad, General-Purpose, Low-Voltage, Rail-to-Rail Output Op Amps

Typical Operating Characteristics (continued)

($T_A = +25^\circ\text{C}$, $V_{EE} = 0$, unless otherwise noted.)

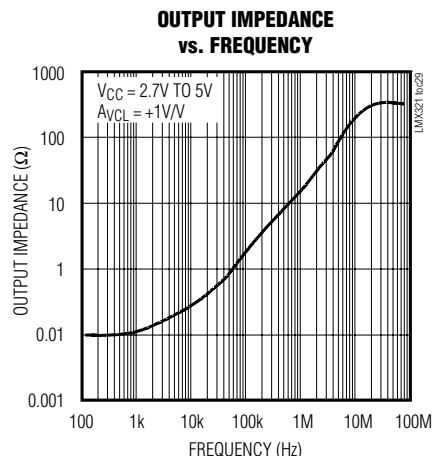
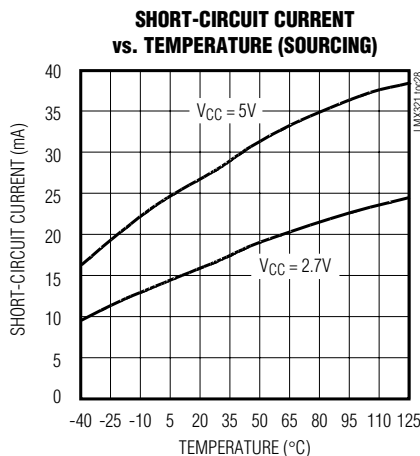
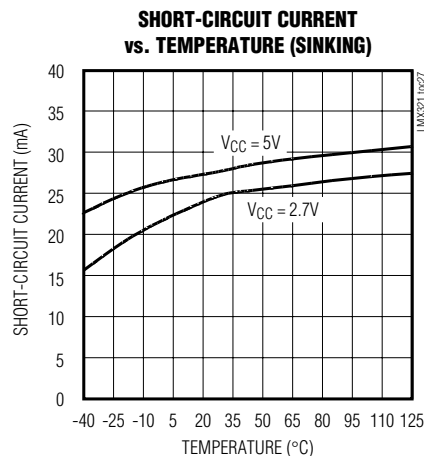

Pin Description

PIN			NAME	FUNCTION
LMX321	LMX358	LMX324		
1	—	—	IN+	Noninverting Amplifier Input
2	4	11	V_{EE}	Negative Supply. Connect to ground for single-supply operation.
3	—	—	IN-	Inverting Amplifier Input
4	—	—	OUT	Output
5	8	4	V_{CC}	Positive Supply
—	1	1	OUT1	Output for Amplifier 1
—	2	2	IN1-	Inverting Input for Amplifier 1
—	3	3	IN1+	Noninverting Input for Amplifier 1
—	7	7	OUT2	Output for Amplifier 2
—	6	6	IN2-	Inverting Input for Amplifier 2
—	5	5	IN2+	Noninverting Input for Amplifier 2
—	—	8	OUT3	Output for Amplifier 3
—	—	9	IN3-	Inverting Input for Amplifier 3
—	—	10	IN3+	Noninverting Input for Amplifier 3
—	—	14	OUT4	Output for Amplifier 4
—	—	13	IN4-	Inverting Input for Amplifier 4
—	—	12	IN4+	Noninverting Input for Amplifier 4

Single/Dual/Quad, General-Purpose, Low-Voltage, Rail-to-Rail Output Op Amps

LMX321/LMX358/LMX324

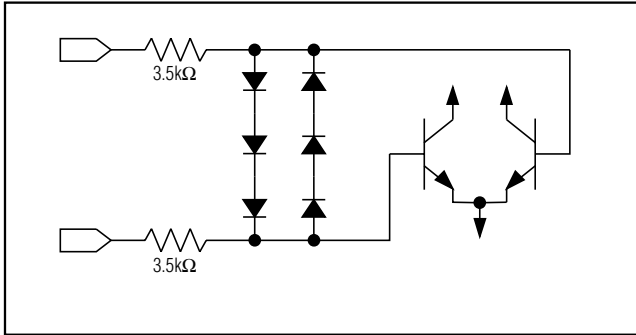

Figure 1. Input Protection Circuit

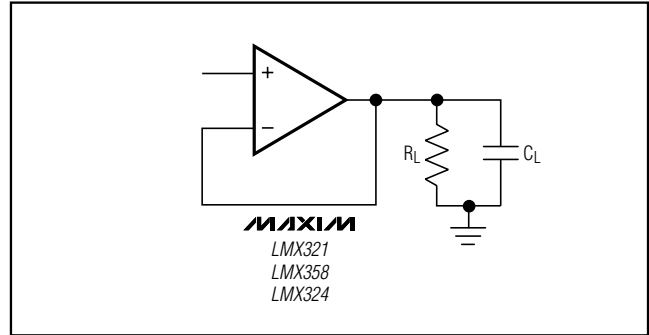

Figure 3. Capacitive-Load-Driving Circuit

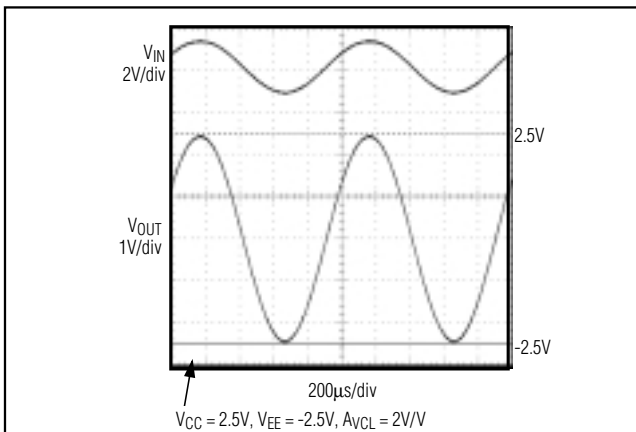

Figure 2. Rail-to-Rail Output Swing

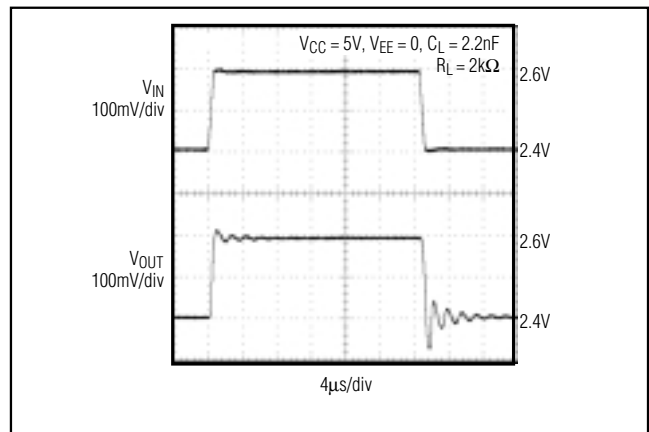

Figure 4. Output With Excessive Capacitive Load

Detailed Description

Input Protection Circuit

The LMX321/LMX358/LMX324's inputs are protected from large differential input voltages by internal 3.5kΩ series resistors and back-to-back triple diode stacks across the inputs (Figure 1). For differential input voltages (much less than 1.8V), input resistance is typically 3MΩ. For differential input voltages greater than 1.8V, input resistance is around 7kΩ, and the input bias current can be approximated by the following equation:

$$I_{BIAS} = (V_{DIFF} - 1.8V) / 7k\Omega$$

In the region where the differential input voltage approaches 1.8V, input resistance decreases exponentially from 3MΩ to 7kΩ as the diode block begins conducting. Inversely, the bias current increases with the same curve.

Rail-to-Rail Output Stage

The LMX321/LMX358/LMX324 drive 2kΩ loads and still typically swing within 40mV of the supply rails. Figure 2

shows the output voltage swing of the LMX321 configured with $A_{VCL} = +2V/V$.

Driving Capacitive Loads

Driving a capacitive load can cause instability in many op amps, especially those with low quiescent current. The LMX321/LMX358/LMX324 are unity-gain stable for a range of capacitive loads to above 400pF. Figure 4 shows the response of the LMX321 with an excessive capacitive load. Adding a series resistor between the output and the load capacitor (Figure 5) improves the circuit's response by isolating the load capacitance from the op amp's output.

Applications Information

Power-Up

The LMX321/LMX358/LMX324 outputs typically settle within 10µs after power-up. Figure 6 shows the output voltage on power-up and power-down.

Single/Dual/Quad, General-Purpose, Low-Voltage, Rail-to-Rail Output Op Amps

Power Supplies and Layout

The LMX321/LMX358/LMX324 operate from a single +2.3V to +7V power supply. Bypass the power supply with a 0.1µF capacitor to ground as close to VCC as possible.

Good layout techniques optimize performance by minimizing the amount of stray capacitance at the op amp's inputs and outputs. Place external components close to the op amp to minimize trace lengths and stray capacitance.

Chip Information

LMX321 TRANSISTOR COUNT: 88

LMX358 TRANSISTOR COUNT: 175

LMX324 TRANSISTOR COUNT: 349

PROCESS: Bipolar

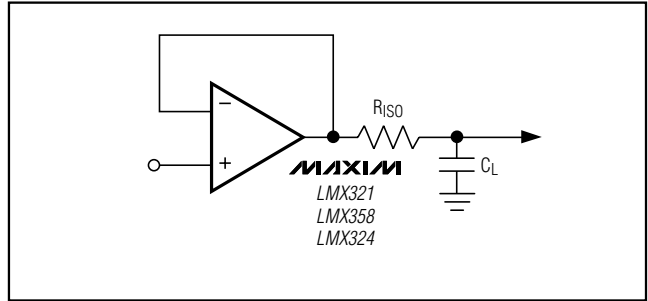

Figure 5. Capacitive-Load-Driving Circuit With Isolation Resistor

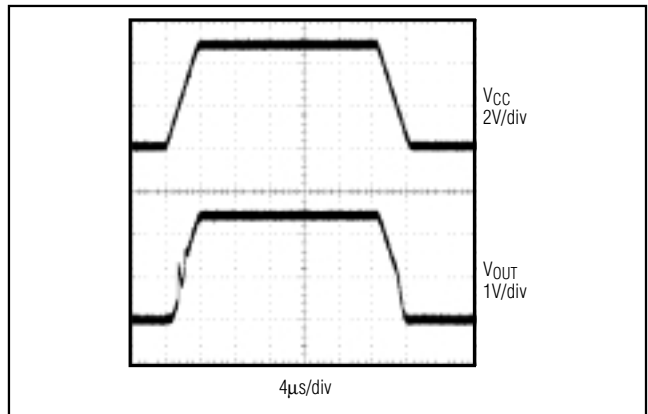

Figure 6. Power-Up/Power-Down Waveform

Selector Guide

PART	AMPLIFIERS PER PACKAGE	TOP MARK
LMX321AXK-T	1	ACP
LMX321AUK-T	1	ADSQ
LMX358AKA-T	2	AAIR
LMX358ASA	2	—
LMX358AUA	2	—
LMX324ASD	4	—
LMX324AUD	4	—

Single/Dual/Quad, General-Purpose, Low-Voltage, Rail-to-Rail Output Op Amps

Package Information

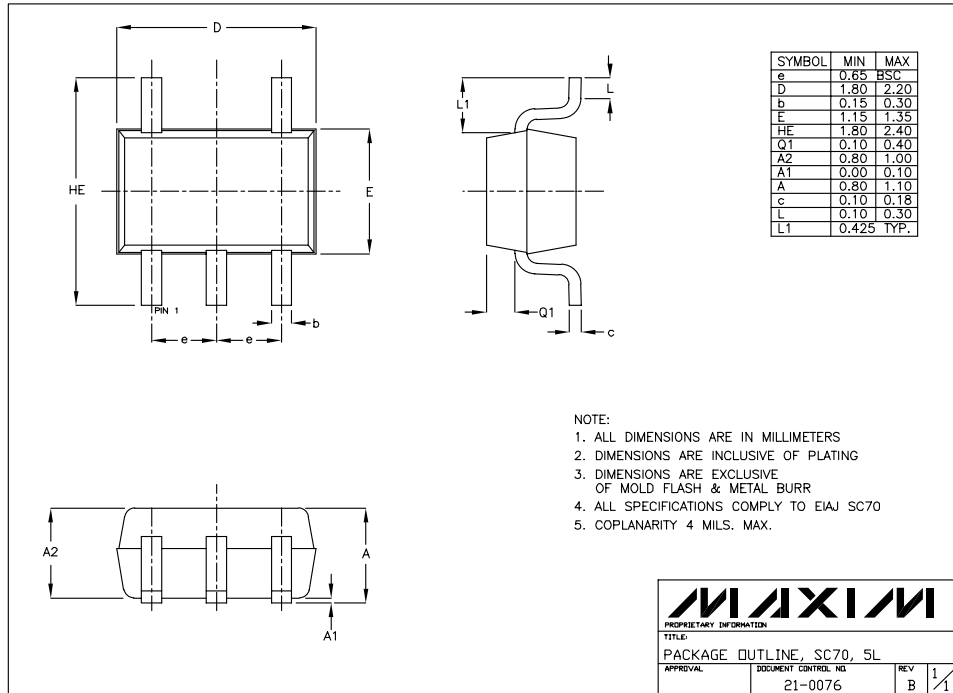

SC70-5L EPS

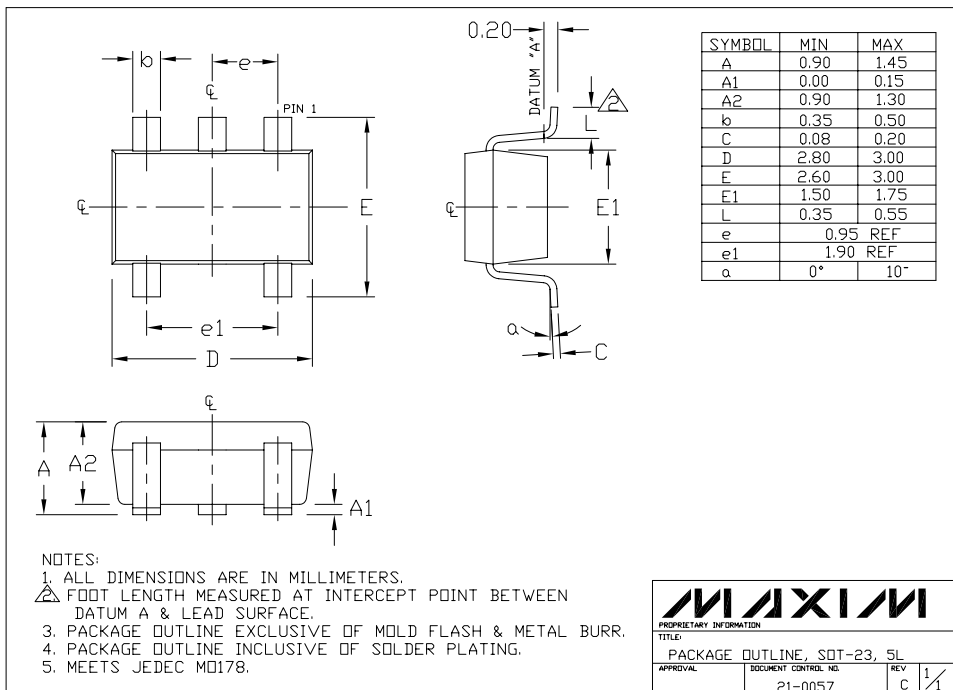

SOT23 EPS

LMX321/LMX358/LMX324

Single/Dual/Quad, General-Purpose, Low-Voltage, Rail-to-Rail Output Op Amps

Package Information (continued)

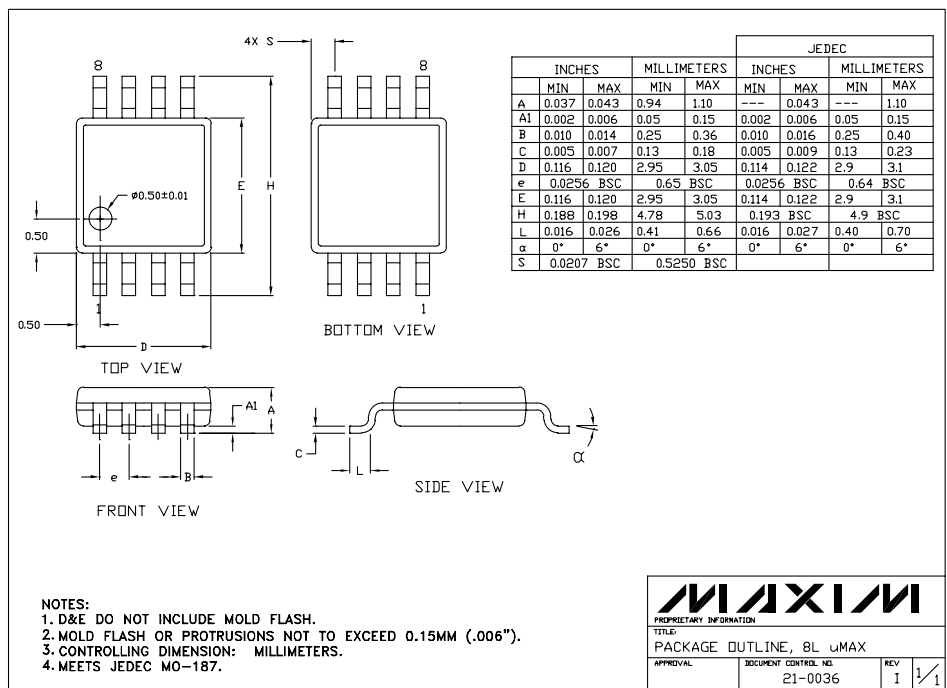
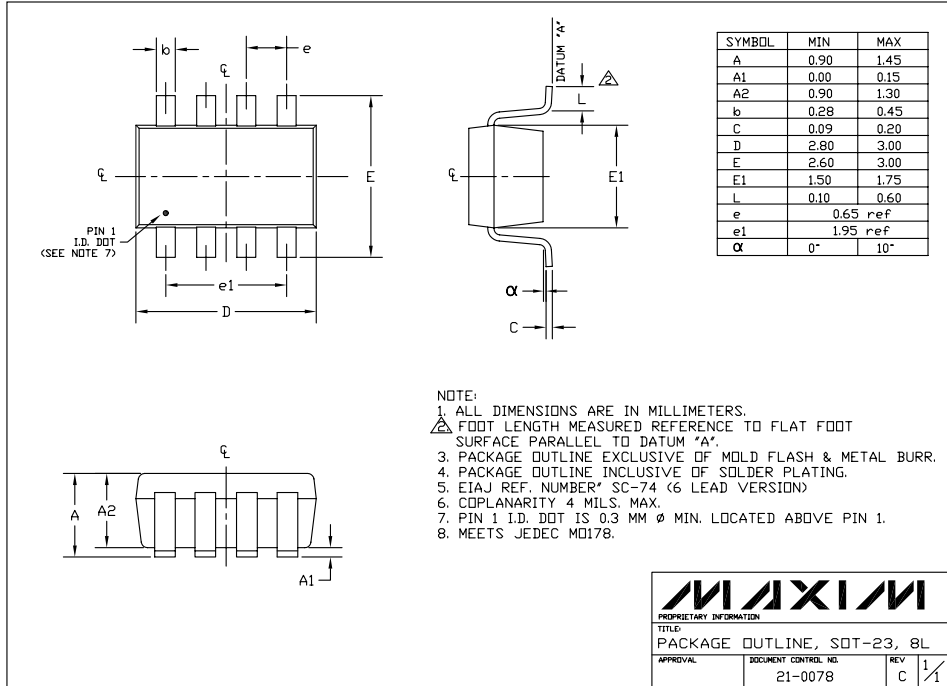

Single/Dual/Quad, General Purpose, Low-Voltage, Rail-to-Rail Output Op Amps

Package Information (continued)

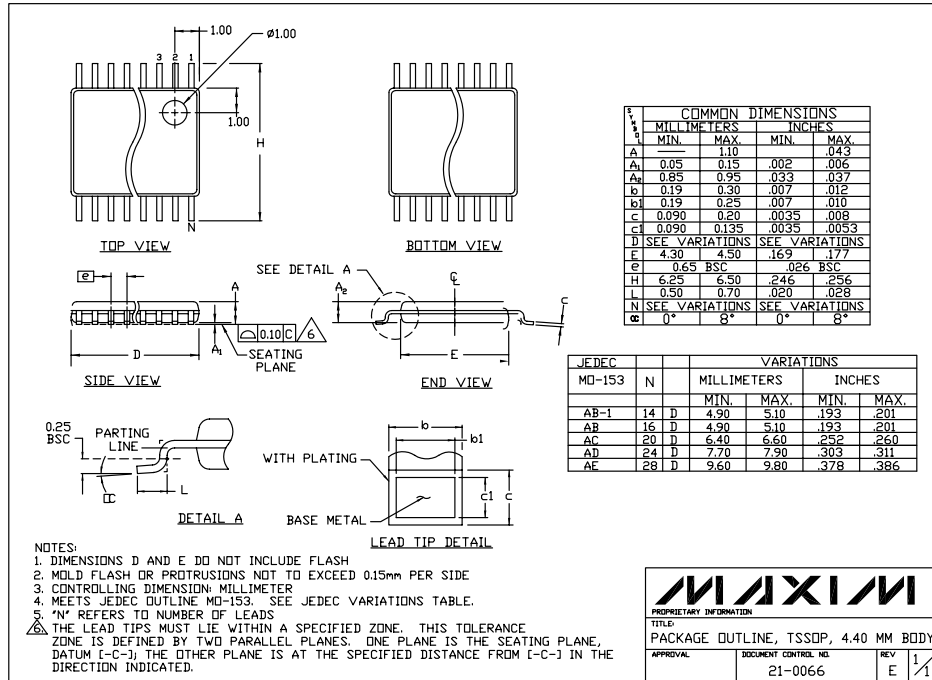

TSSOP, NO PADS/EPIS

LMX321/LMX358/LMX324

Maxim cannot assume responsibility for use of any circuitry other than circuitry entirely embodied in a Maxim product. No circuit patent licenses are implied. Maxim reserves the right to change the circuitry and specifications without notice at any time.