



**MOTOROLA**

# Three-Terminal Negative Voltage Regulators

The MC79M00 series of fixed output negative voltage regulators are intended as complements to the popular MC78M00 series devices.

Available in fixed output voltage options of -5.0, -8.0, -12 and -15 V, these regulators employ current limiting, thermal shutdown, and safe-area compensation – making them remarkably rugged under most operating conditions. With adequate heatsinking they can deliver output currents in excess of 0.5 A.

- No External Components Required
- Internal Thermal Overload Protection
- Internal Short Circuit Current Limiting
- Output Transistor Safe-Area Compensation
- Also Available in Surface Mount DPAK (DT) Package

### DEVICE TYPE/NOMINAL OUTPUT VOLTAGE

MC79M05	-5.0 V	MC79M12	-12 V
MC79M08	-8.0 V	MC79M15	-15 V

### ORDERING INFORMATION

Device	Output Voltage Tolerance	Operating Temperature Range	Package
MC79MXXBDT, BDT-1	4.0%	$T_J = -40^\circ \text{ to } +125^\circ \text{C}$	DPAK
MC79MXXBT			Plastic Power
MC79MXXCDT, CDT-1	4.0%	$T_J = 0^\circ \text{ to } +125^\circ \text{C}$	DPAK
MC79MXXCT			Plastic Power

XX indicates nominal voltage.

### Representative Schematic Diagram

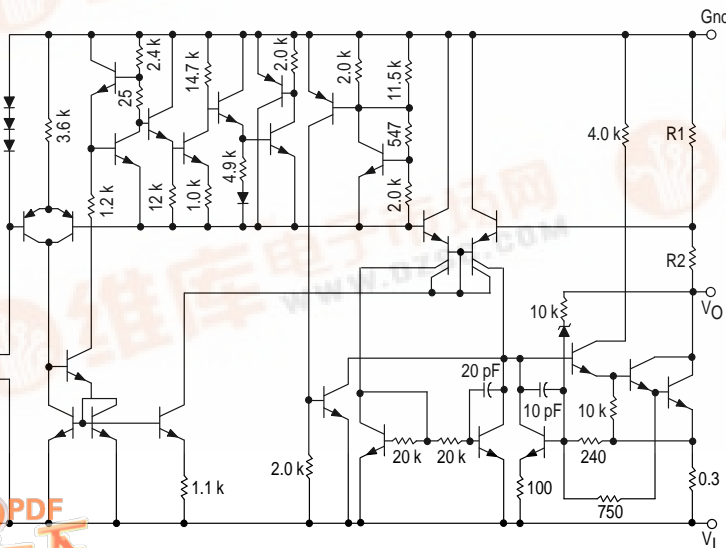

This device contains 31 active transistors.

## MC79M00 Series

### THREE-TERMINAL NEGATIVE FIXED VOLTAGE REGULATORS

**T SUFFIX**  
PLASTIC PACKAGE  
CASE 221A

Heatsink surface connected to Pin 2.

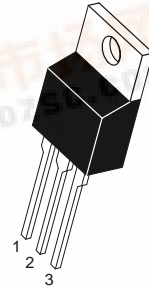

- Pin 1. Ground  
2. Input  
3. Output

**DT SUFFIX**  
PLASTIC PACKAGE  
CASE 369A  
(DPAK)

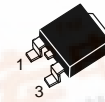

**DT-1 SUFFIX**  
PLASTIC PACKAGE  
CASE 369  
(DPAK)

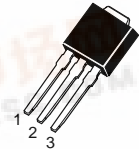

Heatsink surface (shown as terminal 4 in case outline drawing) is connected to Pin 2.

### STANDARD APPLICATION

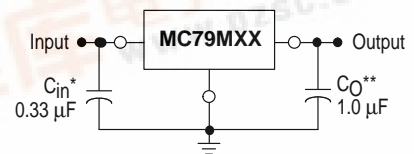

A common ground is required between the input and the output voltages. The input voltage must remain typically 1.1 V more negative even during the high point of the input ripple voltage.

XX, These two digits of the type number indicate nominal voltage.

\*  $C_{in}$  is required if regulator is located an appreciable distance from power supply filter.

\*\*  $C_o$  improve stability and transient response.

## MC79M00

### MAXIMUM RATINGS ( $T_A = 25^\circ\text{C}$ , unless otherwise noted.)

Rating	Symbol	Value	Unit
Input Voltage	$V_I$	-35	Vdc
Power Dissipation			
Case 221A			
$T_A = 25^\circ\text{C}$	$P_D$	Internally Limited	W
Thermal Resistance, Junction-to-Ambient	$\theta_{JA}$	65	$^\circ\text{C/W}$
Thermal Resistance, Junction-to-Case	$\theta_{JC}$	5.0	$^\circ\text{C/W}$
Case 369 and 369A (DPAK)			
$T_A = 25^\circ\text{C}$	$P_D$	Internally Limited	W
Thermal Resistance, Junction-to-Ambient	$\theta_{JA}$	92	$^\circ\text{C/W}$
Thermal Resistance, Junction-to-Case	$\theta_{JC}$	6.0	$^\circ\text{C/W}$
Storage Junction Temperature	$T_{stg}$	-65 to +150	$^\circ\text{C}$
Junction Temperature	$T_J$	150	$^\circ\text{C}$

NOTE: ESD data available upon request.

### THERMAL CHARACTERISTICS

Characteristic	Symbol	Value	Unit
Thermal Resistance, Junction-to-Ambient	$R_{\theta JA}$	65	$^\circ\text{C/W}$
Thermal Resistance, Junction-to-Case	$R_{\theta JC}$	5.0	$^\circ\text{C/W}$

### MC79M05B, C

#### ELECTRICAL CHARACTERISTICS ( $V_I = -10\text{ V}$ , $I_O = 350\text{ mA}$ , $T_{low}$ to $T_{high}$ [Note 2], unless otherwise noted.)

Characteristic	Symbol	Min	Typ	Max	Unit
Output Voltage ( $T_J = 25^\circ\text{C}$ )	$V_O$	-4.8	-5.0	-5.2	Vdc
Line Regulation, $T_J = 25^\circ\text{C}$ (Note 1) -7.0 Vdc $\geq V_I \geq$ -25 Vdc -8.0 Vdc $\geq V_I \geq$ -18 Vdc	$Reg_{line}$	-	7.0 2.0	50 30	mV
Load Regulation, $T_J = 25^\circ\text{C}$ (Note 1) 5.0 mA $\leq I_O \leq$ 500 mA	$Reg_{load}$	-	30	100	mV
Output Voltage -7.0 Vdc $\geq V_I \geq$ -25 Vdc, 5.0 mA $\leq I_O \leq$ 350 mA	$V_O$	-4.75	-	-5.25	Vdc
Input Bias Current ( $T_J = 25^\circ\text{C}$ )	$I_{IB}$	-	4.3	8.0	mA
Input Bias Current Change -8.0 Vdc $\geq V_I \geq$ -25 Vdc, $I_O = 350\text{ mA}$ 5.0 mA $\leq I_O \leq$ 350 mA, $V_I = -10\text{ V}$	$\Delta I_{IB}$	-	-	0.4 0.4	mA
Output Noise Voltage, $T_A = 25^\circ\text{C}$ , 10 Hz $\leq f \leq$ 100 kHz	$V_n$	-	40	-	$\mu\text{V}$
Ripple Rejection ( $f = 120\text{ Hz}$ )	RR	54	66	-	dB
Dropout Voltage $I_O = 500\text{ mA}$ , $T_J = 25^\circ\text{C}$	$V_I - V_O$	-	1.1	-	Vdc
Average Temperature Coefficient of Output Voltage $I_O = 5.0\text{ mA}$ , $0^\circ\text{C} \leq T_J \leq 125^\circ\text{C}$	$\Delta V_O / \Delta T$	-	0.2	-	mV/ $^\circ\text{C}$

NOTES: 1. Load and line regulation are specified at constant temperature. Change in  $V_O$  due to heating effects must be taken into account separately. Pulse testing with low duty cycle is used.

2. B =  $T_{low}$  to  $T_{high}$ ,  $-40^\circ\text{C} < T_J < 125^\circ\text{C}$

C =  $T_{low}$  to  $T_{high}$ ,  $0^\circ\text{C} < T_J < 125^\circ\text{C}$

## MC79M00

### MC79M08B, C

**ELECTRICAL CHARACTERISTICS** ( $V_I = -10\text{ V}$ ,  $I_O = 350\text{ mA}$ ,  $T_{\text{low}}$  to  $T_{\text{high}}$  [Note 2], unless otherwise noted.)

Characteristic	Symbol	Min	Typ	Max	Unit
Output Voltage ( $T_J = 25^\circ\text{C}$ )	$V_O$	-7.7	-8.0	-8.3	Vdc
Line Regulation, $T_J = 25^\circ\text{C}$ (Note 1) -7.0 Vdc $\geq V_I \geq -25\text{ Vdc}$ -8.0 Vdc $\geq V_I \geq -18\text{ Vdc}$	Reg <sub>line</sub>	-	5.0 3.0	80 50	mV
Load Regulation, $T_J = 25^\circ\text{C}$ (Note 1) $5.0\text{ mA} \leq I_O \leq 500\text{ mA}$	Reg <sub>load</sub>	-	30	100	mV
Output Voltage -7.0 Vdc $\geq V_I \geq -25\text{ Vdc}$ , $5.0\text{ mA} \leq I_O \leq 350\text{ mA}$	$V_O$	-7.6	-8.0	-8.4	Vdc
Input Bias Current ( $T_J = 25^\circ\text{C}$ )	$I_{IB}$	-	-	8.0	mA
Input Bias Current Change -8.0 Vdc $\geq V_I \geq -25\text{ Vdc}$ , $I_O = 350\text{ mA}$ $5.0\text{ mA} \leq I_O \leq 350\text{ mA}$ , $V_I = -10\text{ V}$	$\Delta I_{IB}$	-	-	0.4 0.4	mA
Output Noise Voltage, $T_A = 25^\circ\text{C}$ , $10\text{ Hz} \leq f \leq 100\text{ kHz}$	$V_n$	-	60	-	$\mu\text{V}$
Ripple Rejection ( $f = 120\text{ Hz}$ )	RR	54	63	-	dB
Dropout Voltage $I_O = 500\text{ mA}$ , $T_J = 25^\circ\text{C}$	$V_I - V_O$	-	1.1	-	Vdc
Average Temperature Coefficient of Output Voltage $I_O = 5.0\text{ mA}$ , $0^\circ\text{C} \leq T_J \leq 125^\circ\text{C}$	$\Delta V_O / \Delta T$	-	0.4	-	mV/ $^\circ\text{C}$

### MC79M12B, C

**ELECTRICAL CHARACTERISTICS** ( $V_I = -19\text{ V}$ ,  $I_O = 350\text{ mA}$ ,  $T_{\text{low}}$  to  $T_{\text{high}}$  [Note 2], unless otherwise noted.)

Characteristic	Symbol	Min	Typ	Max	Unit
Output Voltage ( $T_J = 25^\circ\text{C}$ )	$V_O$	-11.5	-12	-12.5	Vdc
Line Regulation, $T_J = 25^\circ\text{C}$ (Note 1) -14.5 Vdc $\geq V_I \geq -30\text{ Vdc}$ -15 Vdc $\geq V_I \geq -25\text{ Vdc}$	Reg <sub>line</sub>	-	5.0 3.0	80 50	mV
Load Regulation, $T_J = 25^\circ\text{C}$ (Note 1) $5.0\text{ mA} \leq I_O \leq 500\text{ mA}$	Reg <sub>load</sub>	-	30	240	mV
Output Voltage -14.5 Vdc $\geq V_I \geq -30\text{ Vdc}$ , $5.0\text{ mA} \leq I_O \leq 350\text{ mA}$	$V_O$	-11.4	-	-12.6	Vdc
Input Bias Current ( $T_J = 25^\circ\text{C}$ )	$I_{IB}$	-	4.4	8.0	mA
Input Bias Current Change -14.5 Vdc $\geq V_I \geq -30\text{ Vdc}$ , $I_O = 350\text{ mA}$ $5.0\text{ mA} \leq I_O \leq 350\text{ mA}$ , $V_I = -19\text{ V}$	$\Delta I_{IB}$	-	-	0.4 0.4	mA
Output Noise Voltage, $T_A = 25^\circ\text{C}$ , $10\text{ Hz} \leq f \leq 100\text{ kHz}$	$V_n$	-	75	-	$\mu\text{V}$
Ripple Rejection ( $f = 120\text{ Hz}$ )	RR	54	60	-	dB
Dropout Voltage $I_O = 500\text{ mA}$ , $T_J = 25^\circ\text{C}$	$V_I - V_O$	-	1.1	-	Vdc
Average Temperature Coefficient of Output Voltage $I_O = 5.0\text{ mA}$ , $0^\circ\text{C} \leq T_J \leq 125^\circ\text{C}$	$\Delta V_O / \Delta T$	-	-0.8	-	mV/ $^\circ\text{C}$

**NOTES:** 1. Load and line regulation are specified at constant temperature. Change in  $V_O$  due to heating effects must be taken into account separately. Pulse testing with low duty cycle is used.

2. B =  $T_{\text{low}}$  to  $T_{\text{high}}$ ,  $-40^\circ\text{C} < T_J < 125^\circ\text{C}$   
C =  $T_{\text{low}}$  to  $T_{\text{high}}$ ,  $0^\circ\text{C} < T_J < 125^\circ\text{C}$

# MC79M00

## MC79M15B, C

### ELECTRICAL CHARACTERISTICS ( $V_I = -23\text{ V}$ , $I_O = 350\text{ mA}$ , $T_{\text{low}}$ to $T_{\text{high}}$ [Note 2], unless otherwise noted.)

Characteristic	Symbol	Min	Typ	Max	Unit
Output Voltage ( $T_J = 25^\circ\text{C}$ )	$V_O$	-14.4	-15	-15.6	Vdc
Line Regulation, $T_J = 25^\circ\text{C}$ (Note 1) -17.5 Vdc $\geq V_I \geq$ -30 Vdc -18 Vdc $\geq V_I \geq$ -28 Vdc	Reg <sub>line</sub>	-	5.0 3.0	80 50	mV
Load Regulation, $T_J = 25^\circ\text{C}$ (Note 1) $5.0\text{ mA} \leq I_O \leq 500\text{ mA}$	Reg <sub>load</sub>	-	30	240	mV
Output Voltage -17.5 Vdc $\geq V_I \geq$ -30 Vdc, $5.0\text{ mA} \leq I_O \leq 350\text{ mA}$	$V_O$	-14.25	-	-15.75	Vdc
Input Bias Current ( $T_J = 25^\circ\text{C}$ )	$I_{IB}$	-	4.4	8.0	mA
Input Bias Current Change -17.5 Vdc $\geq V_I \geq$ -30 Vdc, $I_O = 350\text{ mA}$ $5.0\text{ mA} \leq I_O \leq 350\text{ mA}$ , $V_I = -23\text{ V}$	$\Delta I_{IB}$	-	-	0.4 0.4	mA
Output Noise Voltage, $T_A = 25^\circ\text{C}$ , $10\text{ Hz} \leq f \leq 100\text{ kHz}$	$V_n$	-	90	-	$\mu\text{V}$
Ripple Rejection ( $f = 120\text{ Hz}$ )	RR	54	60	-	dB
Dropout Voltage $I_O = 500\text{ mA}$ , $T_J = 25^\circ\text{C}$	$V_I - V_O$	-	1.1	-	Vdc
Average Temperature Coefficient of Output Voltage $I_O = 5.0\text{ mA}$ , $0^\circ\text{C} \leq T_J \leq 125^\circ\text{C}$	$\Delta V_O / \Delta T$	-	-1.0	-	mV/ $^\circ\text{C}$

**NOTES:** 1. Load and line regulation are specified at constant temperature. Change in  $V_O$  due to heating effects must be taken into account separately. Pulse testing with low duty cycle is used.

2. B =  $T_{\text{low}}$  to  $T_{\text{high}}$ ,  $-40^\circ\text{C} < T_J < 125^\circ\text{C}$

C =  $T_{\text{low}}$  to  $T_{\text{high}}$ ,  $0^\circ\text{C} < T_J < 125^\circ\text{C}$

**Figure 1. DPAK Thermal Resistance and Maximum Power Dissipation versus P.C.B. Copper Length**

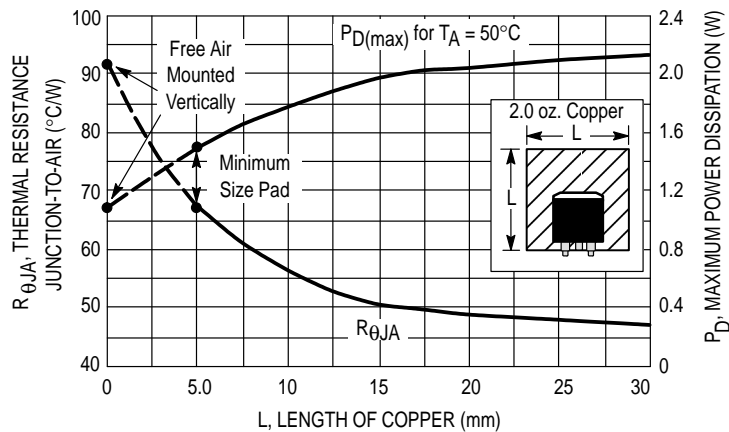

# MC79M00

## OUTLINE DIMENSIONS

**T SUFFIX**  
**PLASTIC PACKAGE**  
**CASE 221A-06**  
**ISSUE Y**

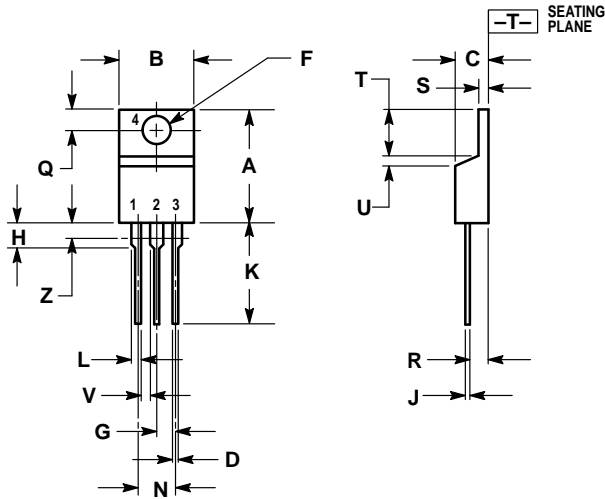

- NOTES:
1. DIMENSIONING AND TOLERANCING PER ANSI Y14.5M, 1982.
  2. CONTROLLING DIMENSION: INCH.
  3. DIMENSION Z DEFINES A ZONE WHERE ALL BODY AND LEAD IRREGULARITIES ARE ALLOWED.

DIM	INCHES		MILLIMETERS	
	MIN	MAX	MIN	MAX
A	0.570	0.620	14.48	15.75
B	0.380	0.405	9.66	10.28
C	0.160	0.190	4.07	4.82
D	0.025	0.035	0.64	0.88
F	0.142	0.147	3.61	3.73
G	0.095	0.105	2.42	2.66
H	0.110	0.155	2.80	3.93
J	0.018	0.025	0.46	0.64
K	0.500	0.562	12.70	14.27
L	0.045	0.060	1.15	1.52
N	0.190	0.210	4.83	5.33
Q	0.100	0.120	2.54	3.04
R	0.080	0.110	2.04	2.79
S	0.045	0.055	1.15	1.39
T	0.235	0.255	5.97	6.47
U	0.000	0.050	0.00	1.27
V	0.045	—	1.15	—
Z	—	0.080	—	2.04

**DT SUFFIX**  
**PLASTIC PACKAGE**  
**CASE 369A-13**  
**(DPAK)**  
**ISSUE Y**

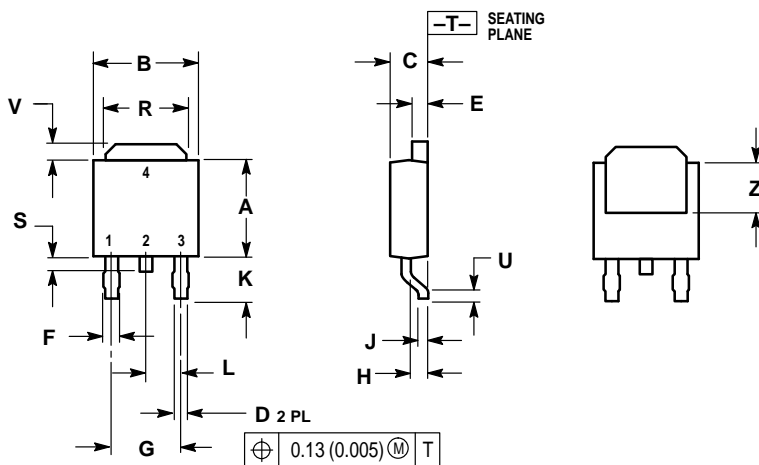

- NOTES:
1. DIMENSIONING AND TOLERANCING PER ANSI Y14.5M, 1982.
  2. CONTROLLING DIMENSION: INCH.

DIM	INCHES		MILLIMETERS	
	MIN	MAX	MIN	MAX
A	0.235	0.250	5.97	6.35
B	0.250	0.265	6.35	6.73
C	0.086	0.094	2.19	2.38
D	0.027	0.035	0.69	0.88
E	0.033	0.040	0.84	1.01
F	0.037	0.047	0.94	1.19
G	0.180 BSC	—	4.58 BSC	—
H	0.034	0.040	0.87	1.01
J	0.018	0.023	0.46	0.58
K	0.102	0.114	2.60	2.89
L	0.090 BSC	—	2.29 BSC	—
R	0.175	0.215	4.45	5.46
S	0.020	0.050	0.51	1.27
U	0.020	—	0.51	—
V	0.030	0.050	0.77	1.27
Z	0.138	—	3.51	—

# MC79M00

## OUTLINE DIMENSIONS

DT-1 SUFFIX  
 PLASTIC PACKAGE  
 CASE 369-07  
 (DPAK)  
 ISSUE K

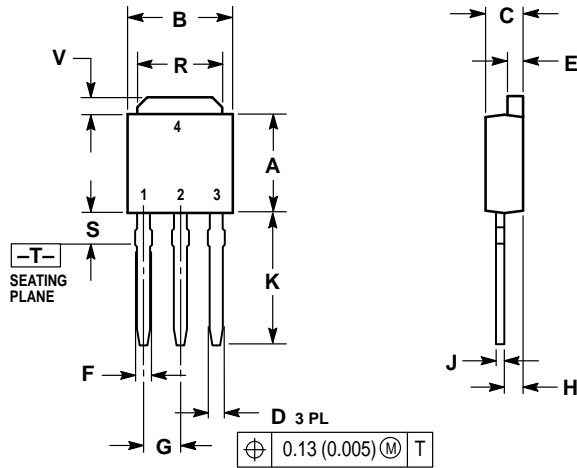

NOTES:

1. DIMENSIONING AND TOLERANCING PER ANSI Y14.5M, 1982.
2. CONTROLLING DIMENSION: INCH.

DIM	INCHES		MILLIMETERS	
	MIN	MAX	MIN	MAX
A	0.235	0.250	5.97	6.35
B	0.250	0.265	6.35	6.73
C	0.086	0.094	2.19	2.38
D	0.027	0.035	0.69	0.88
E	0.033	0.040	0.84	1.01
F	0.037	0.047	0.94	1.19
G	0.090 BSC		2.29 BSC	
H	0.034	0.040	0.87	1.01
J	0.018	0.023	0.46	0.58
K	0.350	0.380	8.89	9.65
R	0.175	0.215	4.45	5.46
S	0.050	0.090	1.27	2.28
V	0.030	0.050	0.77	1.27

## MC79M00

Motorola reserves the right to make changes without further notice to any products herein. Motorola makes no warranty, representation or guarantee regarding the suitability of its products for any particular purpose, nor does Motorola assume any liability arising out of the application or use of any product or circuit, and specifically disclaims any and all liability, including without limitation consequential or incidental damages. "Typical" parameters which may be provided in Motorola data sheets and/or specifications can and do vary in different applications and actual performance may vary over time. All operating parameters, including "Typicals" must be validated for each customer application by customer's technical experts. Motorola does not convey any license under its patent rights nor the rights of others. Motorola products are not designed, intended, or authorized for use as components in systems intended for surgical implant into the body, or other applications intended to support or sustain life, or for any other application in which the failure of the Motorola product could create a situation where personal injury or death may occur. Should Buyer purchase or use Motorola products for any such unintended or unauthorized application, Buyer shall indemnify and hold Motorola and its officers, employees, subsidiaries, affiliates, and distributors harmless against all claims, costs, damages, and expenses, and reasonable attorney fees arising out of, directly or indirectly, any claim of personal injury or death associated with such unintended or unauthorized use, even if such claim alleges that Motorola was negligent regarding the design or manufacture of the part. Motorola and  are registered trademarks of Motorola, Inc. Motorola, Inc. is an Equal Opportunity/Affirmative Action Employer.

# MC79M00

**How to reach us:**

**USA/EUROPE/Locations Not Listed:** Motorola Literature Distribution;  
P.O. Box 20912; Phoenix, Arizona 85036. 1-800-441-2447 or 602-303-5454

**MFAX:** RMFAX0@email.sps.mot.com – TOUCHTONE 602-244-6609  
**INTERNET:** <http://Design-NET.com>

**JAPAN:** Nippon Motorola Ltd.; Tatsumi-SPD-JLDC, 6F Seibu-Butsuryu-Center,  
3-14-2 Tatsumi Koto-Ku, Tokyo 135, Japan. 03-81-3521-8315

**ASIA/PACIFIC:** Motorola Semiconductors H.K. Ltd.; 8B Tai Ping Industrial Park,  
51 Ting Kok Road, Tai Po, N.T., Hong Kong. 852-26629298



MOTOROLA