

# BCR8PM-14

MEDIUM POWER USE  
INSULATED TYPE, PLANAR PASSIVATION TYPE

**BCR8PM-14**

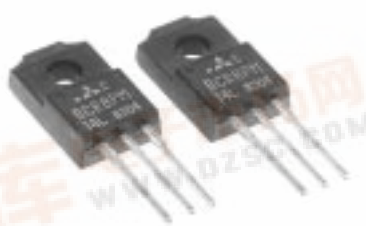

- IT (RMS) ..... 8A
- VDRM ..... 700V
- IFGT I, IRGT I, IRGT III ..... 30mA (20mA) \*5
- Viso ..... 1500V
- UL Recognized: File No. E80276

**OUTLINE DRAWING** Dimensions in mm

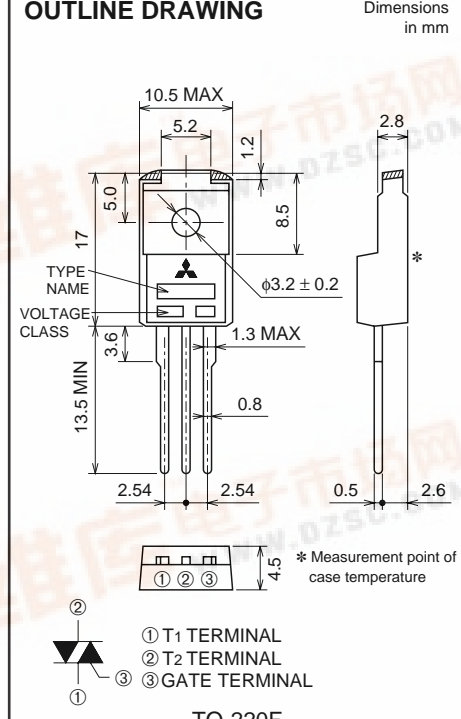

① T1 TERMINAL  
② T2 TERMINAL  
③ GATE TERMINAL

TO-220F

\* Measurement point of case temperature

## APPLICATION

Switching mode power supply, light dimmer, electric flasher unit, control of household equipment such as TV sets · stereo · refrigerator · washing machine · infrared kotatsu · carpet, solenoid drivers, small motor control, copying machine, electric tool, other general purpose control applications

## MAXIMUM RATINGS

Symbol	Parameter	Voltage class	
		14	Unit
VDRM	Repetitive peak off-state voltage *1	700	V
VDSM	Non-repetitive peak off-state voltage *1	840	V

Symbol	Parameter	Conditions	Ratings	Unit
IT (RMS)	RMS on-state current	Commercial frequency, sine full wave 360° conduction, Tc=88°C	8	A
ITSM	Surge on-state current	60Hz sine wave 1 full cycle, peak value, non-repetitive	80	A
I <sup>2</sup> <sub>t</sub>	I <sup>2</sup> <sub>t</sub> for fusing	Value corresponding to 1 cycle of half wave 60Hz, surge on-state current	26	A <sup>2</sup> s
PGM	Peak gate power dissipation		5	W
PG (AV)	Average gate power dissipation		0.5	W
VGM	Peak gate voltage		10	V
IGM	Peak gate current		2	A
T <sub>j</sub>	Junction temperature		-40 ~ +125	°C
T <sub>stg</sub>	Storage temperature		-40 ~ +125	°C
—	Weight	Typical value	2.0	g
Viso	Isolation voltage	Ta=25°C, AC 1 minute, T1 · T2 · G terminal to case	1500	V

\*1 Gate open.



# BCR8PM-14

MEDIUM POWER USE  
INSULATED TYPE, PLANAR PASSIVATION TYPE

## ELECTRICAL CHARACTERISTICS

Symbol	Parameter	Test conditions	Limits			Unit	
			Min.	Typ.	Max.		
IDRM	Repetitive peak off-state current	T <sub>j</sub> =125°C, V <sub>DRM</sub> applied	—	—	2.0	mA	
V <sub>TM</sub>	On-state voltage	T <sub>c</sub> =25°C, I <sub>TM</sub> =12A, Instantaneous measurement	—	—	1.6	V	
V <sub>FGT I</sub>	Gate trigger voltage *2	T <sub>j</sub> =25°C, V <sub>D</sub> =6V, R <sub>L</sub> =6Ω, R <sub>G</sub> =330Ω	I	—	—	1.5	V
V <sub>RGT I</sub>			II	—	—	1.5	V
V <sub>RGT III</sub>			III	—	—	1.5	V
I <sub>FGT I</sub>	Gate trigger current *2	T <sub>j</sub> =25°C, V <sub>D</sub> =6V, R <sub>L</sub> =6Ω, R <sub>G</sub> =330Ω	I	—	—	30 *5	mA
I <sub>RGT I</sub>			II	—	—	30 *5	mA
I <sub>RGT III</sub>			III	—	—	30 *5	mA
V <sub>GD</sub>	Gate non-trigger voltage	T <sub>j</sub> =125°C, V <sub>D</sub> =1/2V <sub>DRM</sub>	0.2	—	—	V	
R <sub>th(j-c)</sub>	Thermal resistance	Junction to case *4	—	—	3.7	°C/W	
(dv/dt) <sub>c</sub>	Critical-rate of rise of off-state commutating voltage		*3	—	—	V/μs	

\*2. Measurement using the gate trigger characteristics measurement circuit.  
 \*3. The critical-rate of rise of the off-state commutating voltage is shown in the table below.  
 \*4. The contact thermal resistance R<sub>th(c-f)</sub> in case of greasing is 0.5°C/W.  
 \*5. High sensitivity (I<sub>GT</sub> ≤ 20mA) is also available. (I<sub>GT</sub> item ①)

Voltage class	V <sub>DRM</sub> (V)	(dv/dt) <sub>c</sub>			Test conditions	Commutating voltage and current waveforms (inductive load)
		Symbol	Min.	Unit		
14	700	R	—	V/μs	1. Junction temperature T <sub>j</sub> =125°C 2. Rate of decay of on-state commutating current (di/dt) <sub>c</sub> =-4.0A/ms 3. Peak off-state voltage V <sub>D</sub> =400V	
		L	10			

## PERFORMANCE CURVES

MAXIMUM ON-STATE CHARACTERISTICS

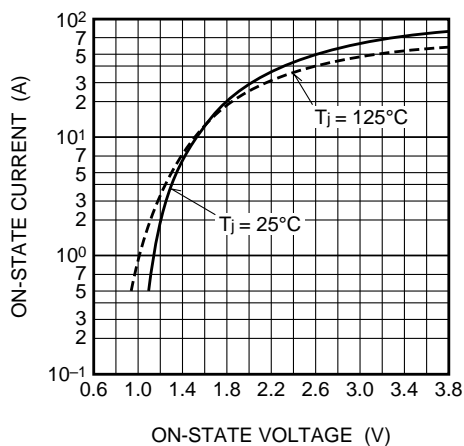

RATED SURGE ON-STATE CURRENT

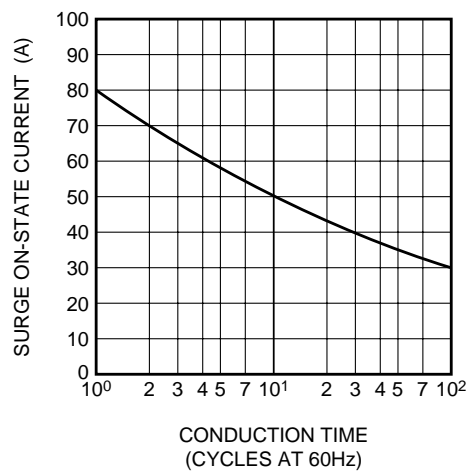

# BCR8PM-14

MEDIUM POWER USE  
INSULATED TYPE, PLANAR PASSIVATION TYPE

**GATE CHARACTERISTICS**

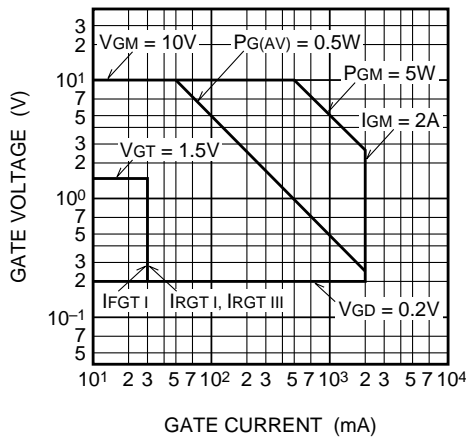

**GATE TRIGGER CURRENT VS. JUNCTION TEMPERATURE**

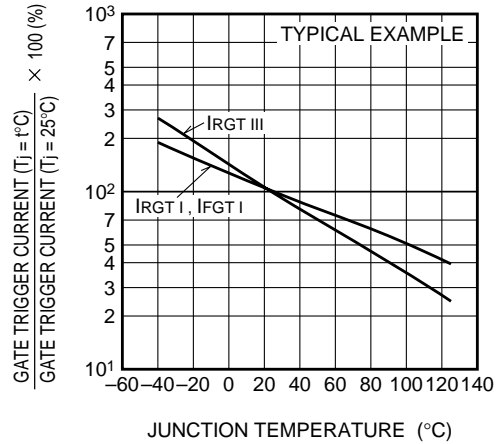

**GATE TRIGGER VOLTAGE VS. JUNCTION TEMPERATURE**

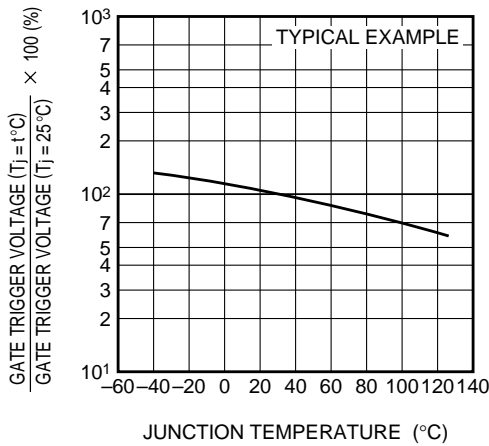

**MAXIMUM TRANSIENT THERMAL IMPEDANCE CHARACTERISTICS (JUNCTION TO CASE)**

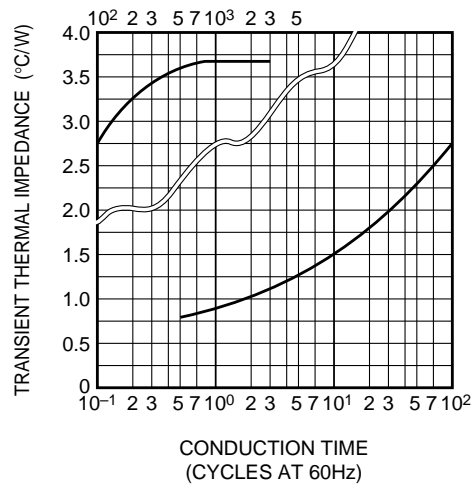

**MAXIMUM TRANSIENT THERMAL IMPEDANCE CHARACTERISTICS (JUNCTION TO AMBIENT)**

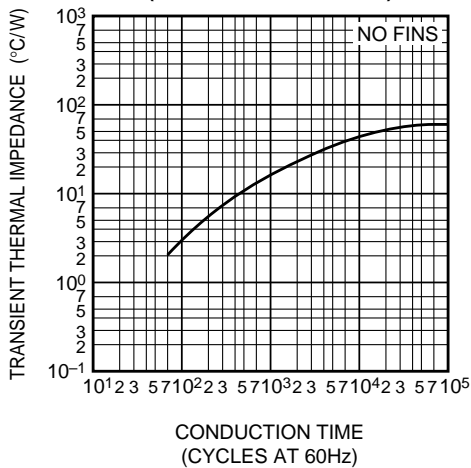

**MAXIMUM ON-STATE POWER DISSIPATION**

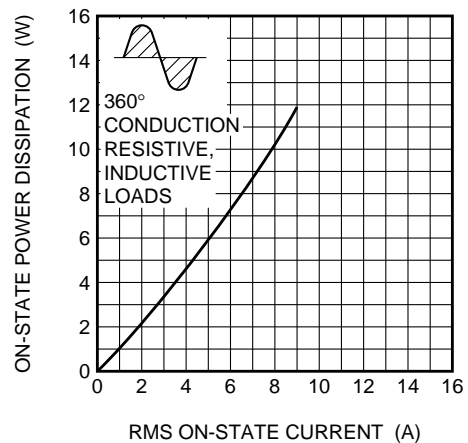

# BCR8PM-14

MEDIUM POWER USE  
INSULATED TYPE, PLANAR PASSIVATION TYPE

**ALLOWABLE CASE TEMPERATURE VS. RMS ON-STATE CURRENT**

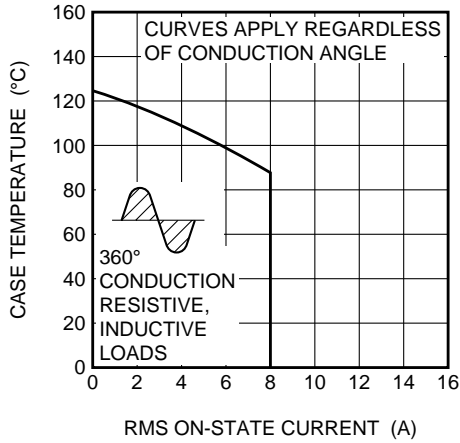

**ALLOWABLE AMBIENT TEMPERATURE VS. RMS ON-STATE CURRENT**

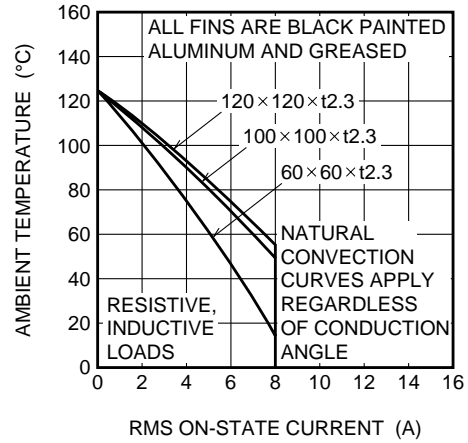

**ALLOWABLE AMBIENT TEMPERATURE VS. RMS ON-STATE CURRENT**

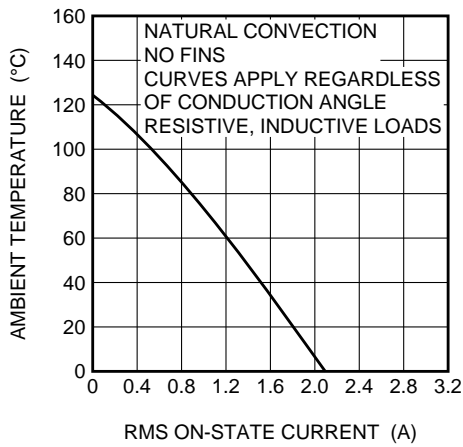

**REPETITIVE PEAK OFF-STATE CURRENT VS. JUNCTION TEMPERATURE**

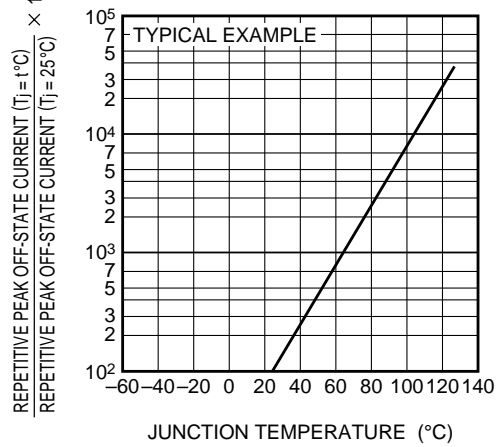

**HOLDING CURRENT VS. JUNCTION TEMPERATURE**

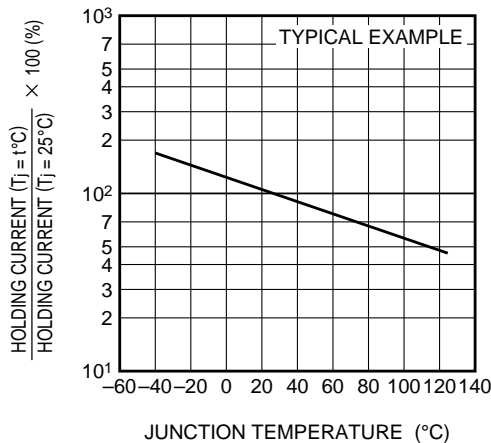

**LACHING CURRENT VS. JUNCTION TEMPERATURE**

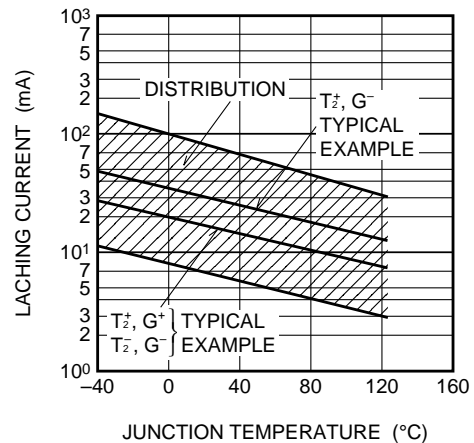

# BCR8PM-14

MEDIUM POWER USE  
INSULATED TYPE, PLANAR PASSIVATION TYPE

**BREAKEOVER VOLTAGE VS. JUNCTION TEMPERATURE**

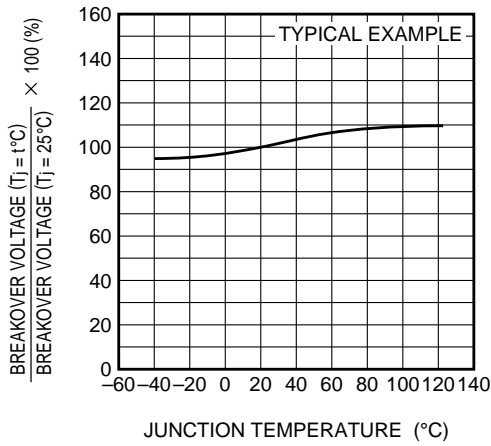

**BREAKEOVER VOLTAGE VS. RATE OF RISE OF OFF-STATE VOLTAGE**

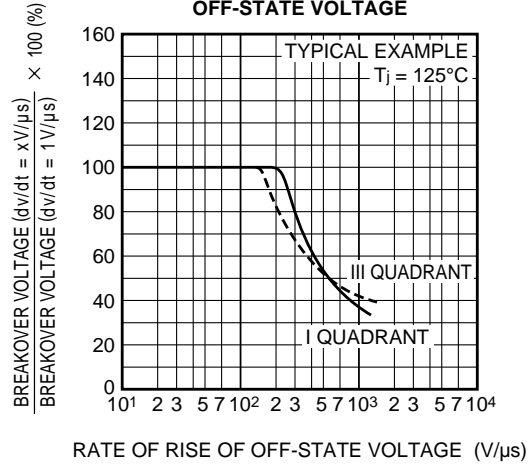

**COMMUTATION CHARACTERISTICS**

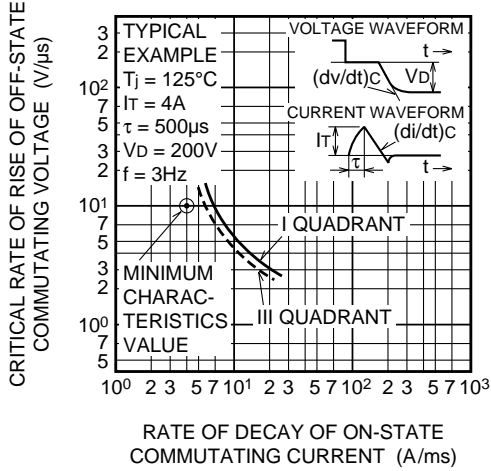

**GATE TRIGGER CURRENT VS. GATE CURRENT PULSE WIDTH**

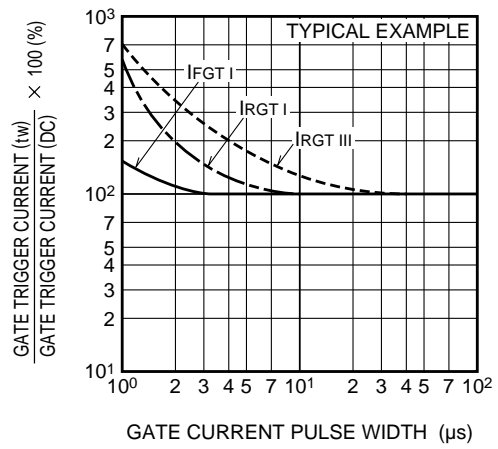

**GATE TRIGGER CHARACTERISTICS TEST CIRCUITS**

