

Bulletin PD-2.272 rev. B 11/02

# International IOR Rectifier

## 95HQ015

### SCHOTTKY RECTIFIER

### 95 Amp

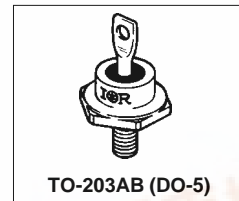

#### Major Ratings and Characteristics

Characteristics	95HQ015	Units
$I_{F(AV)}$ Rectangular waveform	95	A
$V_{RRM}$	15	V
$I_{FSM}$ @ $t_p = 5 \mu s$ sine	7500	A
$V_F$ @ 95 Apk, $T_J = 75^\circ C$	0.39	V
$T_J$ range	-65 to 100	$^\circ C$

#### Description/ Features

The 95HQ015 Schottky rectifier has been optimized for ultra low forward voltage drop specifically for the OR-ing of parallel power supplies. The proprietary barrier technology allows for reliable operation up to  $100^\circ C$  junction temperature. Typical applications are in parallel switching power supplies, converters, reverse battery protection, and redundant power subsystems.

- $100^\circ C$   $T_J$  operation
- Optimized for OR-ing applications
- Ultra low forward voltage drop
- High frequency operation
- Guard ring for enhanced ruggedness and long term reliability
- Hermetic package

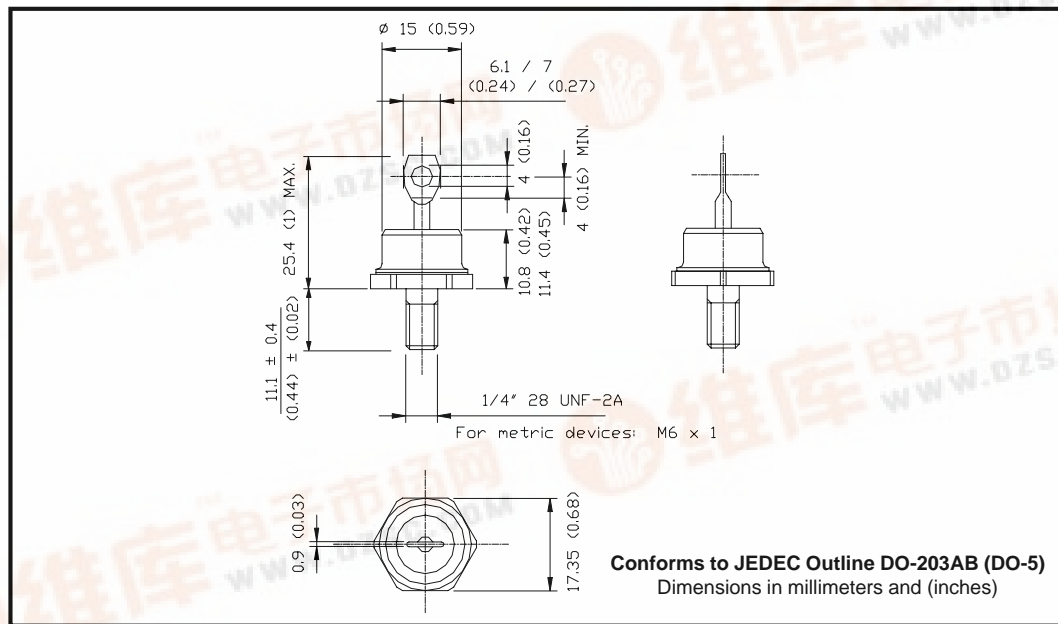

## Voltage Ratings

Part number	95HQ015
$V_R$ Max. DC Reverse Voltage (V)	15
$V_{RWM}$ Max. Working Peak Reverse Voltage (V)	25

## Absolute Maximum Ratings

Parameters	95HQ	Units	Conditions
$I_{F(AV)}$ Max. Average Forward Current * See Fig. 5	95	A	50% duty cycle @ $T_C = 44^\circ\text{C}$ , rectangular wave form
$I_{FSM}$ Max. Peak One Cycle Non-Repetitive Surge Current * See Fig. 7	7500	A	5 $\mu\text{s}$ Sine or 3 $\mu\text{s}$ Rect. pulse
	1200		10ms Sine or 6ms Rect. pulse
$E_{AS}$ Non-Repetitive Avalanche Energy	9	mJ	$T_J = 25^\circ\text{C}$ , $I_{AS} = 2$ Amps, $L = 4.5$ mH
$I_{AR}$ Repetitive Avalanche Current	2	A	Current decaying linearly to zero in 1 $\mu\text{sec}$ Frequency limited by $T_J$ max. $V_A = 3 \times V_R$ typical

## Electrical Specifications

Parameters	95HQ	Units	Conditions
$V_{FM}$ Max. Forward Voltage Drop (1) * See Fig. 1	0.46	V	@ 95A $T_J = 25^\circ\text{C}$
	0.62	V	@ 190A
	0.39	V	@ 95A $T_J = 75^\circ\text{C}$
	0.55	V	@ 190A
$I_{RM}$ Max. Reverse Leakage Current (1) * See Fig. 2	20	mA	$T_J = 25^\circ\text{C}$ $V_R = \text{rated } V_R$
	1000	mA	$T_J = 100^\circ\text{C}$
	890	mA	$T_J = 100^\circ\text{C}$ $V_R = 12\text{V}$
	540	mA	$T_J = 100^\circ\text{C}$ $V_R = 5\text{V}$
$C_T$ Max. Junction Capacitance	3600	pF	$V_R = 5V_{DC}$ , (test signal range 100Khz to 1Mhz) $25^\circ\text{C}$
$L_S$ Typical Series Inductance	7.5	nH	Measured from top of terminal to mounting plane
$dv/dt$ Max. Voltage Rate of Change (Rated $V_R$ )	10000	V/ $\mu\text{s}$	

(1) Pulse Width < 300 $\mu\text{s}$ , Duty Cycle < 2%

## Thermal-Mechanical Specifications

Parameters	95HQ	Units	Conditions
$T_J$ Max. Junction Temperature Range	-65 to 100	$^\circ\text{C}$	
$T_{stg}$ Max. Storage Temperature Range	-65 to 100	$^\circ\text{C}$	
$R_{thJC}$ Max. Thermal Resistance Junction to Case	0.83	$^\circ\text{C/W}$	DC operation * See Fig. 4
$R_{thCS}$ Typical Thermal Resistance, Case to Heatsink	0.25	$^\circ\text{C/W}$	Mounting surface, smooth and greased
wt Approximate Weight	15 (0.53)	g (oz.)	
T Mounting Torque	Min.	23 (20)	Non-lubricated threads
	Max.	46 (40)	
Case Style	DO-203AB(DO-5)	JEDEC	

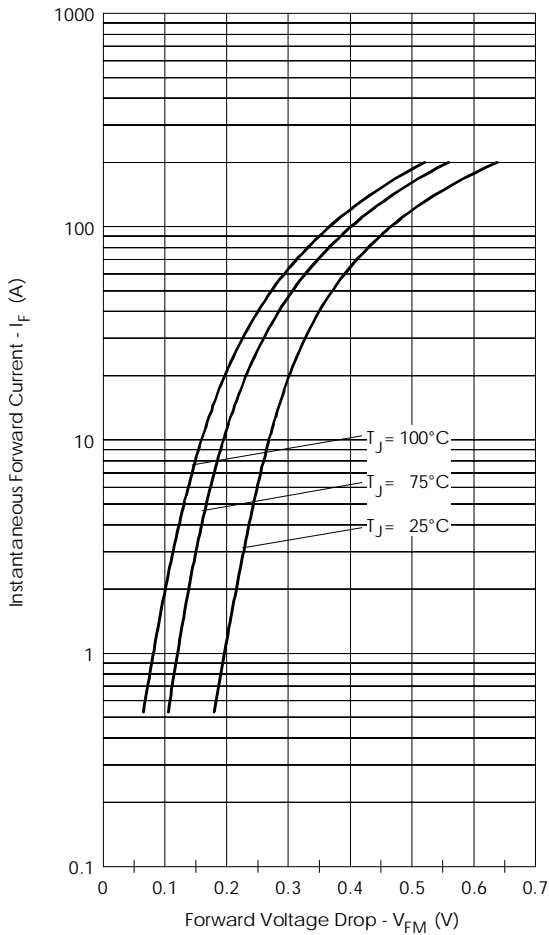

Fig. 1 - Maximum Forward Voltage Drop Characteristics

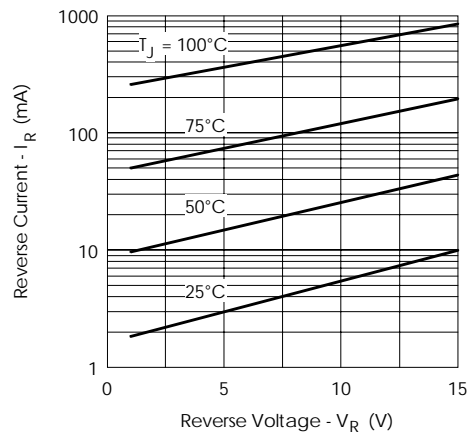

Fig. 2 - Typical Values of Reverse Current Vs. Reverse Voltage

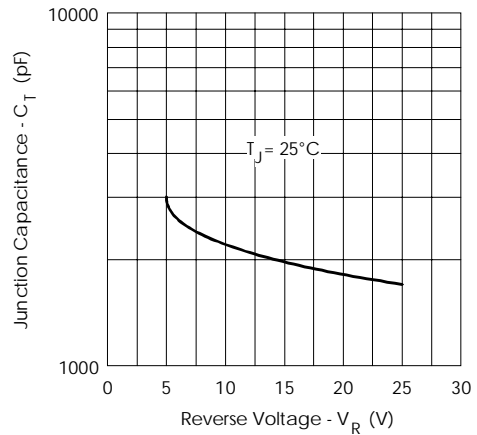

Fig. 3 - Typical Junction Capacitance Vs. Reverse Voltage

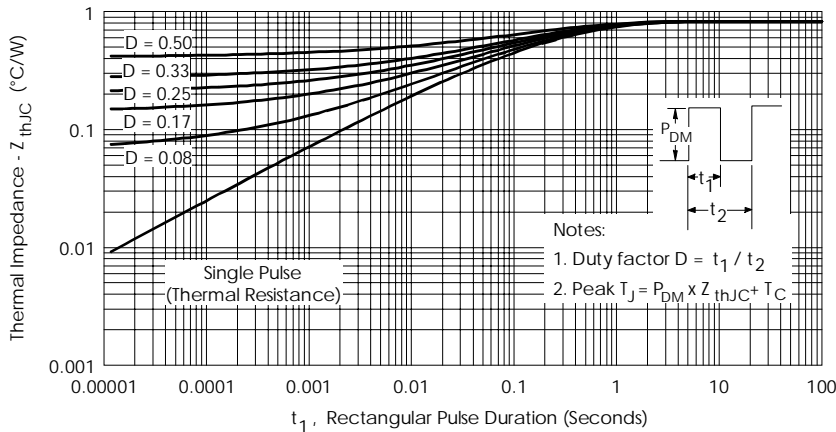

Fig. 4 - Maximum Thermal Impedance  $Z_{thJC}$  Characteristics

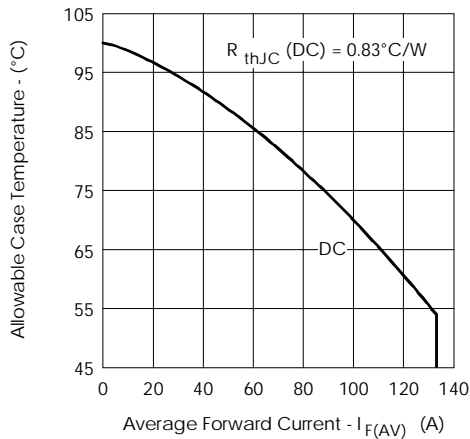

Fig. 5 - Maximum Allowable Case Temperature Vs. Average Forward Current

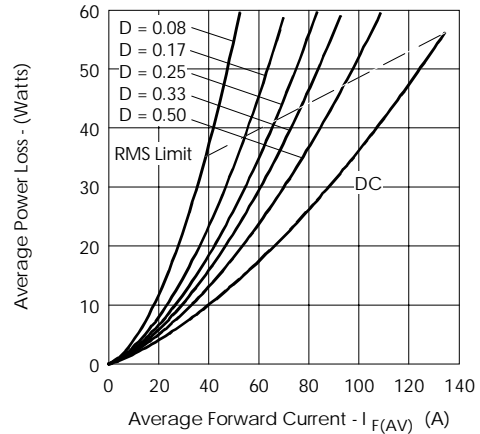

Fig. 6 - Forward Power Loss Characteristics

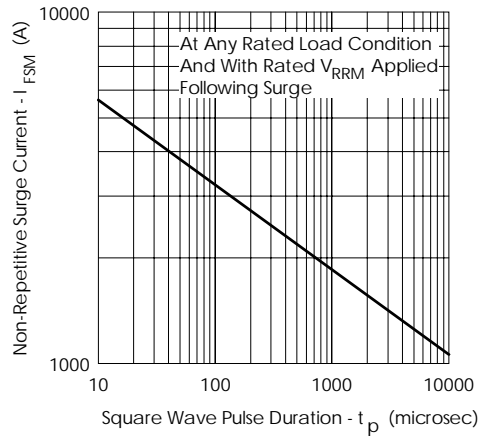

Fig. 7 - Maximum Non-Repetitive Surge Current

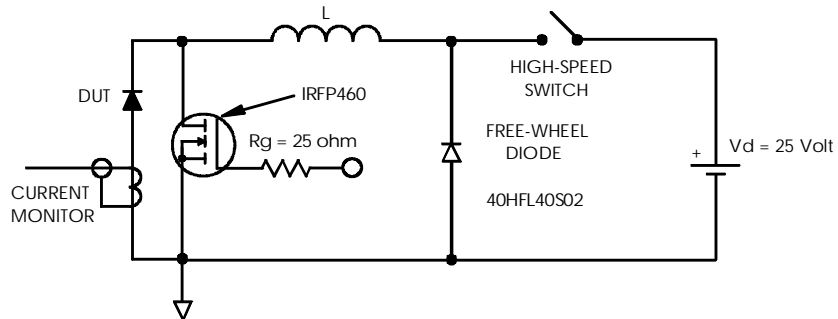

Fig. 8 - Unclamped Inductive Test Circuit

Data and specifications subject to change without notice.  
This product has been designed for Industrial Level.  
Qualification Standards can be found on IR's Web site.

International  
**IOR** Rectifier

**IR WORLD HEADQUARTERS:** 233 Kansas St., El Segundo, California 90245, USA Tel: (310) 252-7105  
TAC Fax: (310) 252-7309  
Visit us at [www.irf.com](http://www.irf.com) for sales contact information. 11/02