

Features

- Usable bandwidth 35 MHz
- For GSM-900 base station applications
- Low loss
- High Attenuation
- Single-ended operation
- No impedance matching required for operation at 50 Ω
- Ceramic Surface Mount Package (SMP)
- Hermetic
- **RoHS** compliant (2002/95/EC), **Pb-free** 

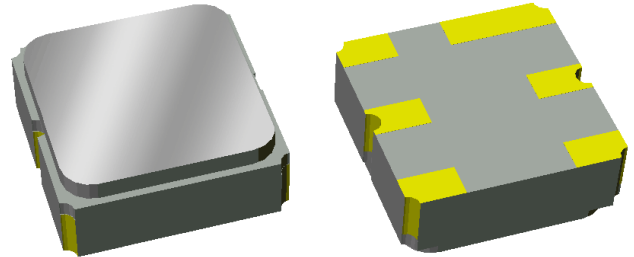

Package

Surface Mount 3.00 x 3.00 x 1.22 mm
SMP-12A

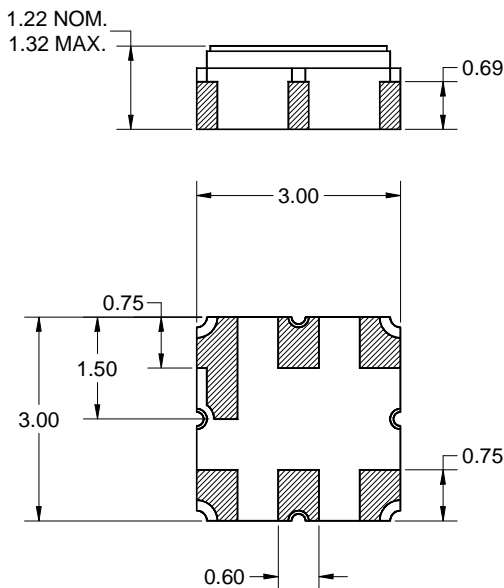

Dimensions shown are nominal in millimeters
All tolerances are ± 0.15 mm except overall
length and width ± 0.10 mm

Body: Al_2O_3 ceramic
Lid: Kovar, Ni plated
Terminations: Au plating 0.5 - 1.0 μ m,
over a 2 - 6 μ m Ni plating

Pin Configuration

Bottom View

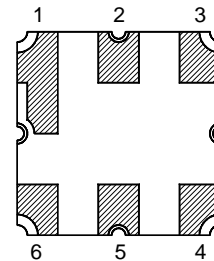

Pin No.	Description
2	Input
5	Output
1,3,4,6	Case ground

Electrical Specifications ⁽¹⁾

Operating Temperature Range: ⁽²⁾ -40 to +85 °C

Parameter ⁽³⁾	Minimum	Typical ⁽⁴⁾	Maximum	Unit
Center Frequency	-	897.5	-	MHz
Maximum Insertion Loss 880 - 915 MHz	-	1.5	2.25	dB
Absolute Attenuation 738 - 773 MHz	40	45	-	dB
773 - 836 MHz	20	25	-	
836 - 860 MHz	17	20	-	
930 - 935 MHz	15	18	-	
935 - 960 MHz	15	18	-	
960 - 1000 MHz	20	24	-	
Amplitude Variation ⁽⁵⁾ 880 - 915 MHz	-	0.5	1.3	dB p-p
Input/Output VSWR 880 - 915 MHz	-	1.8:1	2:1	dB
RF Power Handling ⁽⁶⁾	-	-	17	dBm
Load /Source Impedance ⁽⁷⁾	-	50	-	Ω

Notes:

1. All specifications are based on TriQuint test circuit shown below
2. In production, devices will be tested at room temperature to a guardbanded specification to ensure electrical compliance over temperature
3. Electrical margin has been built into the design to account for the variations due to temperature drift and manufacturing tolerances
4. Typical values are based on average measurements at room temperature
5. Describes the total variation over the defined frequency range
6. Power handling is targeted for an applied CW modulated RF signal at 55 °C for 10,000 hours. The filter is also able to sustain an instantaneous 20dBm signal without decay
7. This is the optimum impedance in order to achieve the performance shown

Test Circuit:

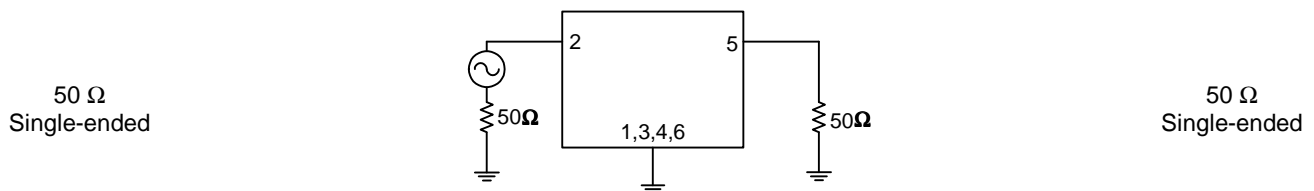

Typical Performance (at room temperature)

Frequency Response

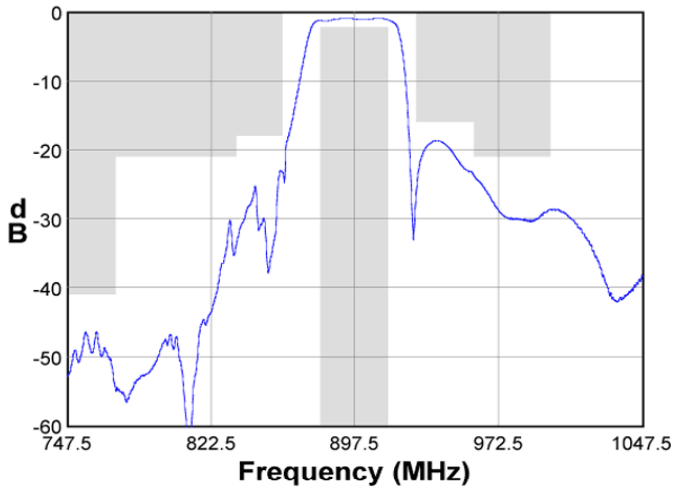

Passband Response

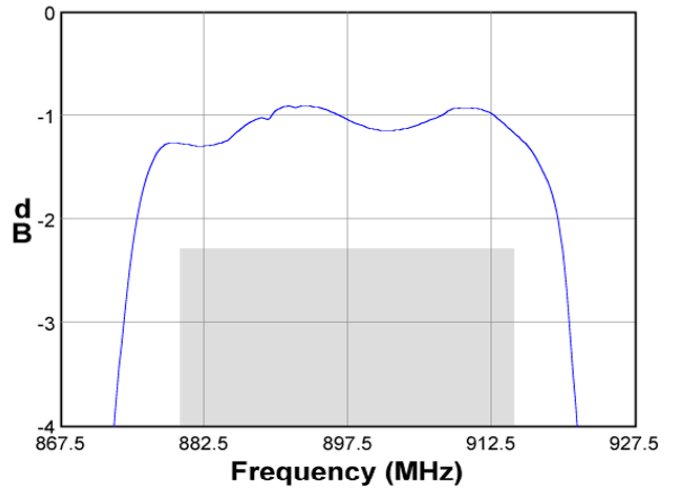

Wideband Response

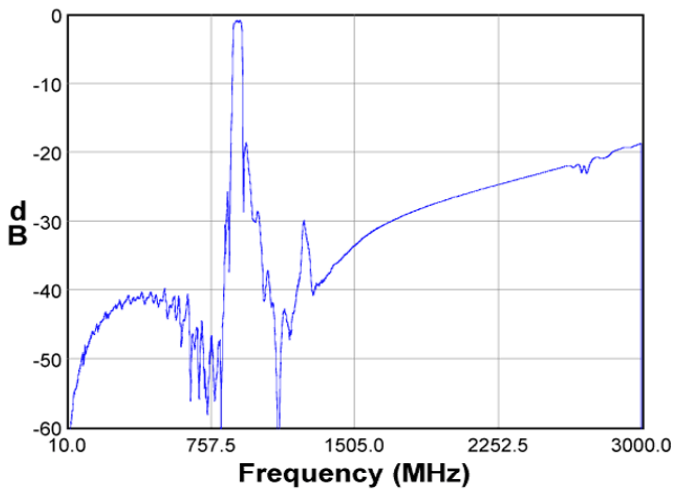

Input/Output VSWR

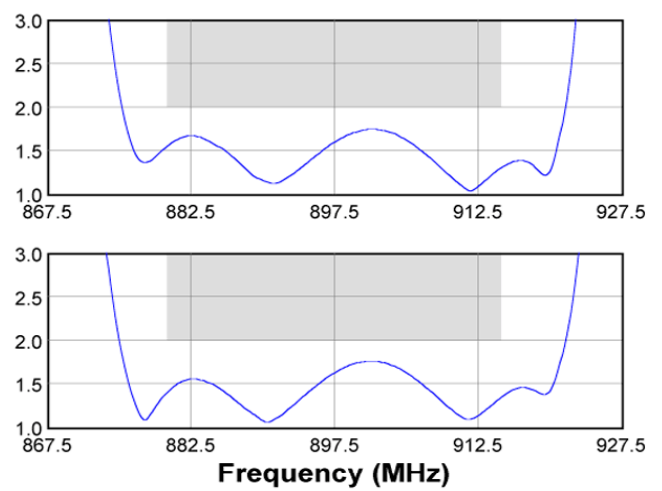

Input Smith Chart

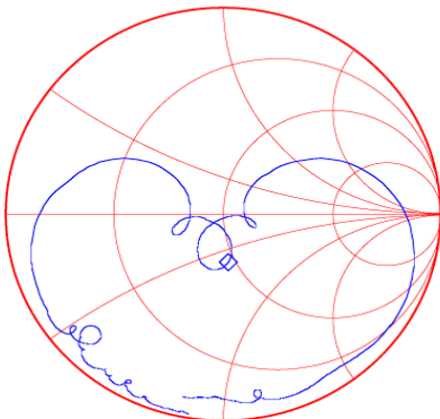

Output Smith Chart

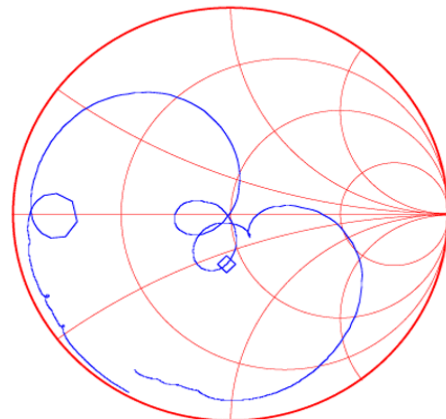

Matching Schematics

50 Ω
Single-ended

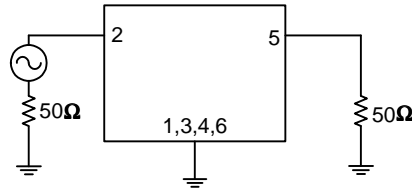

50 Ω
Single-ended

Marking

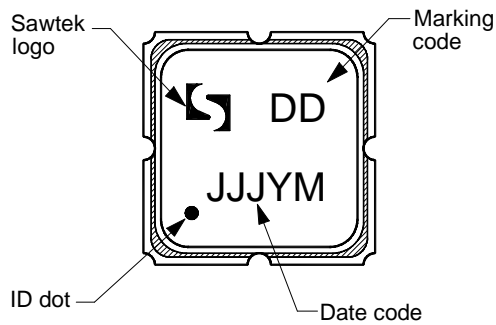

The date code consists of: JJJ = Julian day,
Y = last digit of year, M = manufacturing site code

PCB Footprint

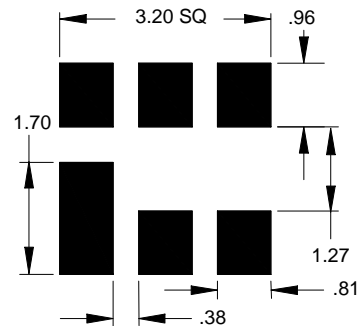

This footprint represents a recommendation only
Dimensions shown are nominal in millimeters

Tape and Reel

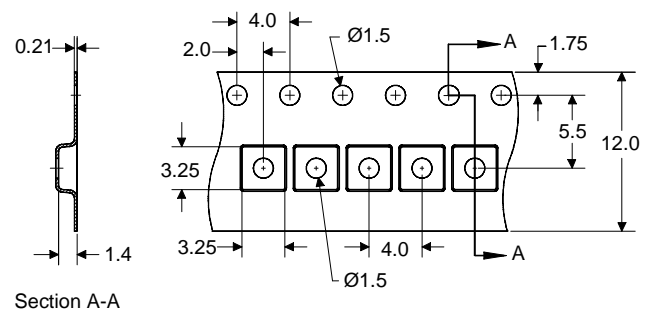
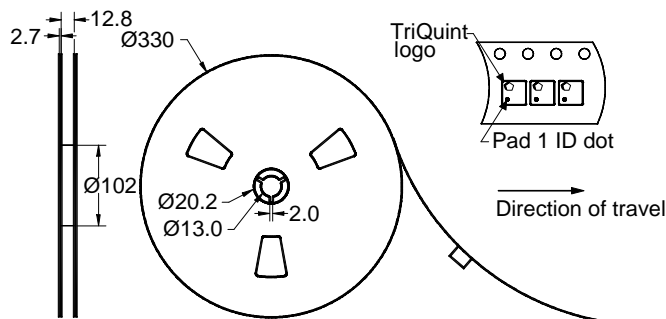

Dimensions shown are nominal in millimeters
Packaging quantity: 5000 units/reel

Maximum Ratings

Parameter	Symbol	Minimum	Maximum	Unit
Operating Temperature Range	T	-40	+85	°C
Storage Temperature Range	T _{stg}	-40	+85	°C

Important Notes

Warnings

- Electrostatic Sensitive Device (ESD) 
- Avoid ultrasonic exposure

RoHS Compliance

- This product complies with EU directive 2002/95/EC (RoHS) 

Solderability

- Compatible with JESD22-B102, Pb-free process, 260C peak reflow temperature ([see soldering profile](#))

Links to Additional Technical Information

[PCB Layout Tips](#)

[Qualification Flowchart](#)

[Soldering Profile](#)

[S-Parameters](#)

[RoHS Information](#)

[Other Technical Information](#)

TriQuint's liability is limited only to the Surface Acoustic Wave (SAW) component(s) described in this data sheet. TriQuint does not accept any liability for applications, processes, circuits or assemblies, which are implemented using any TriQuint component described in this data sheet.

Contact Information

TriQuint 
SEMICONDUCTOR

PO Box 609501
Orlando, FL 32860-9501
USA

Phone: +1 (407) 886-8860
Fax: +1 (407) 886-7061
Email: info-product@tqs.com
Web: www.triquint.com

Or contact one of our worldwide
Network of [sales offices](#),
[Representatives or distributors](#)