



Specification SWBA05

CUSTOMER

Checked by	Approved by

SUPPLIER

Drawn by	Approved by

Contents

1. Description
2. Absolute Maximum Ratings
3. Electro-Optical Characteristics
4. Characteristic Diagram
5. Reliability Test Item and Condition
6. Rank of SWBA05
7. Material
8. Outline Dimension
9. Packing
10. Soldering
11. Precaution for Use



Revision History

Revision No.	Date	Page.	Summary
1.00	December. 21 2009		The institution of New Spec.

SWBA05

1. Description

- 1-chip in one package
- SMT solderability
- Own patent reserved
- RoHS Compliant
- Low Thermal Resistance
- Pb-free Reflow Soldering application
- SWBA05 is very useful side view LED in back light unit application



SWBA05

Features

- 2.8 (W) X 1.2 (D) X 0.8 (T) mm
- Side View LED of Reflector type

Applications

- Flat Backlighting (LCD, Display)
- Mobile Phone, Camera, PDA, Notebook
- Coupling into Light Guide Panel
- AV systems

2. Absolute Maximum Ratings ^{*1}

(T_a = 25°C)

Parameter	Symbol	Value	Unit
Power Dissipation	P_d	120	mW
Forward Current	I_F	30	mA
Peak Forward Current	I_{FM}^{*2}	100	mA
Reverse Voltage	V_R	5	V
Operating Temperature	T_{opr}	-30 ~ +85	°C
Storage Temperature	T_{stg}	-40 ~ +100	°C
Junction Temperature	T_J	125	°C

*1 Care is to be taken that power dissipation does not exceed the absolute maximum rating of the product.

*2 I_{FM} was measured at $T_W \leq 0.1$ msec of pulse width and $D \leq 1/10$ of duty ratio.

3. Electro-Optical Characteristics

(T_a = 25°C)

Parameter		Symbol	Condition	Min	Typ	Max	Unit
Forward Voltage	Rank Z28	V_F	$I_F = 20\text{mA}$	2.8	-	3.0	V
	Rank Z30			3.0	-	3.2	
	Rank Z32			3.2	-	3.4	
	Rank z30			3.0	-	3.4	
Reverse Current		I_R	$V_R = 5\text{V}$	-	-	50	μA
Luminous Intensity ^{*1}	S16H	I_V	$I_F = 20\text{mA}$	1600	-	1700	mcd
	S17H			1700	-	1800	
	S18H			1800	-	1900	
	S19H			1900	-	2000	
	S20H			2000	-	2100	
	S21H			2100	-	2200	
	S22H			2200	-	2300	
Viewing Angle ^{*2}		$2\theta_{1/2}$	$I_F = 20\text{mA}$	120			deg.

*1 Luminous intensity I_V is measured at the peak of the spatial pattern which may not be aligned with the mechanical axis of the LED package.

Luminous Intensity Measurement allowance is ±10%.

*2 $\theta_{1/2}$ is the off-axis where the luminous intensity is 1/2 of the peak intensity.

* Note : All products conform to the listed minimum and maximum specifications for electric and optical characteristics, when operated at 20mA within the maximum ratings shown above.

* All measurements were made under the standardized environment of Seoul Semiconductor.

4. Characteristic Diagram

Forward Current vs. Forward Voltage

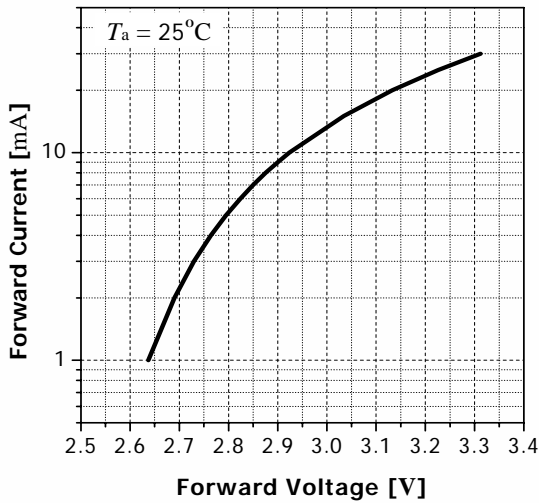

Intensity vs. Forward Current

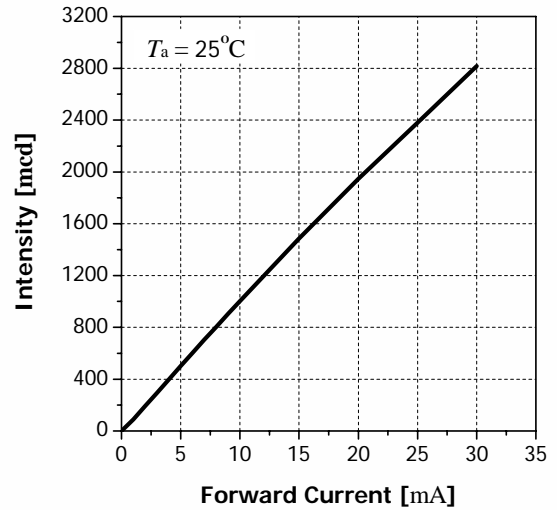

Forward Current vs. Ambient Temperature

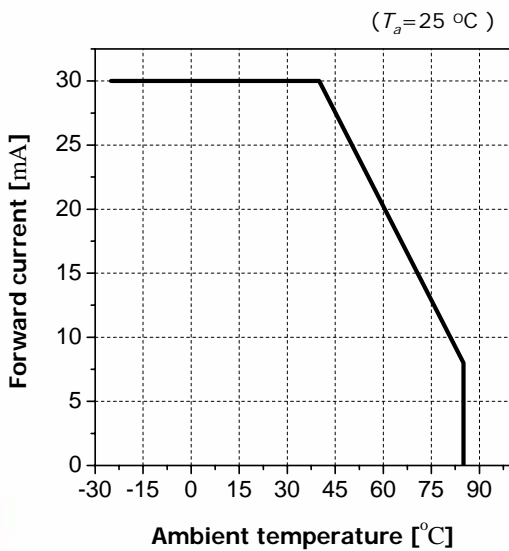

Radiation Diagram

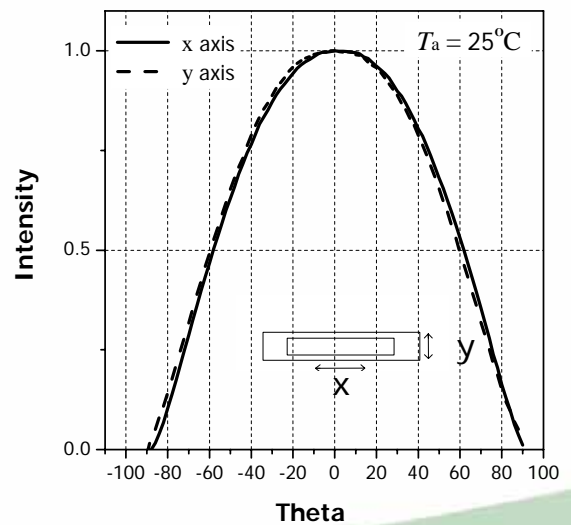

Color Coordinate vs. Forward Current

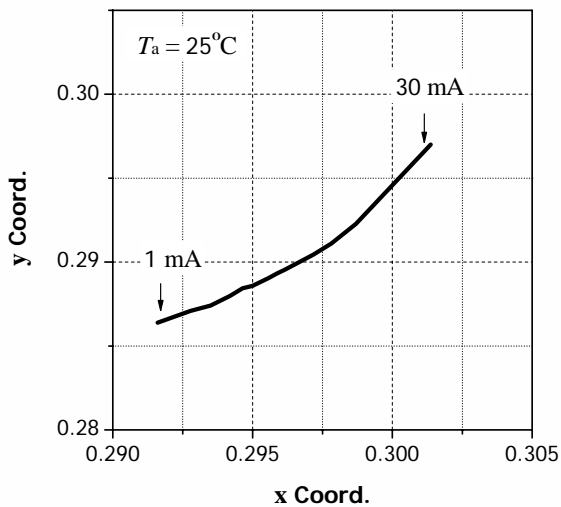

Spectrum

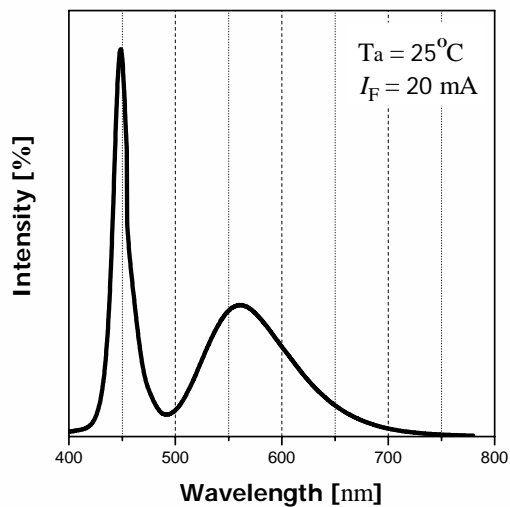

Forward Voltage vs. Ambient Temperature

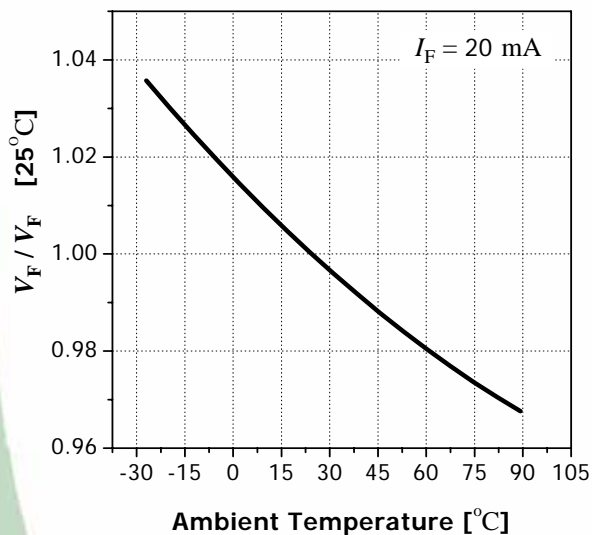

Color Coordinate vs. Ambient Temperature

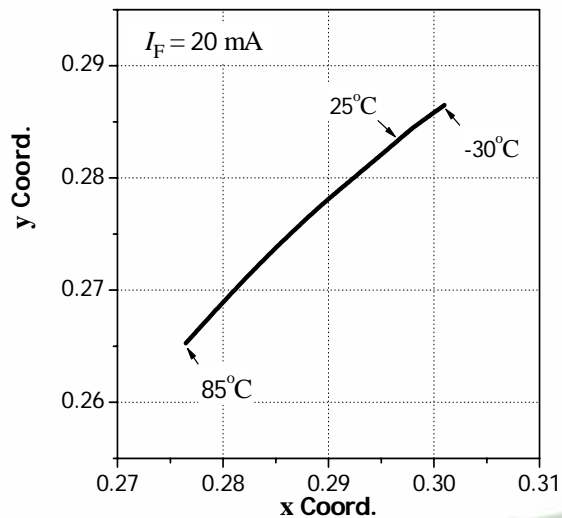

Relative Luminosity vs. Ambient Temperature

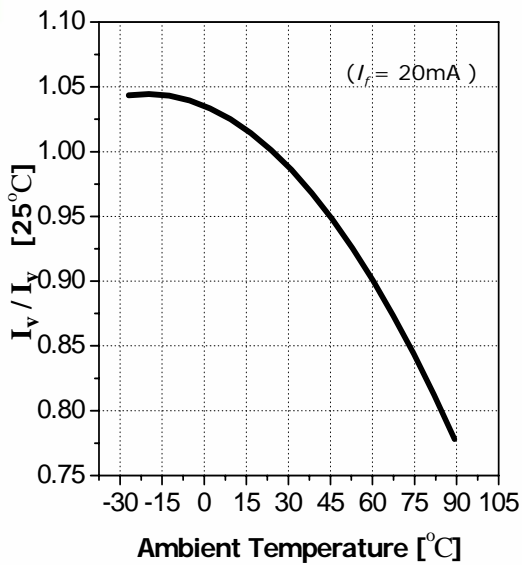

Allowable Forward Current vs. Duty Ratio

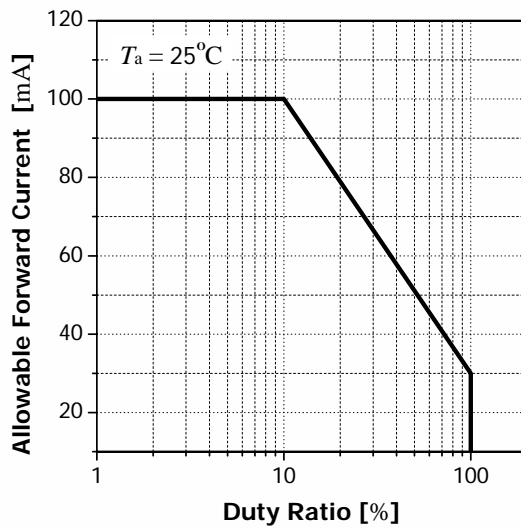

5. Reliability Test

* Test Items and Results

Item	Reference	Test Condition	Duration / Cycle	Number of Damage
Life Test 1	JEITA ED-4701 100 101	$T_a = 25^\circ\text{C}, I_F = 20\text{mA}$	1,000 Hours	0/20
Life Test 2	JEITA ED-4701 100 101	$T_a = 25^\circ\text{C}, I_F = 30\text{mA}$	500 Hours	0/20
Thermal Shock	JEITA ED-4701 300 307	$T_a = -30^\circ\text{C} (30\text{MIN}) \sim 85^\circ\text{C} (30\text{MIN})$	20 Cycle	0/50
High Temperature Life Test	-	$T_a = 85^\circ\text{C}, I_F = 5\text{mA}$	1,000 Hours	0/20
Low Temperature Life Test	-	$T_a = -30^\circ\text{C}, I_F = 20\text{mA}$	1,000 Hours	0/20
High Temperature Storage	JEITA ED-4701 200 201	$T_a = 100^\circ\text{C}$	1,000 Hours	0/20
Low Temperature Storage	JEITA ED-4701 200 202	$T_a = -40^\circ\text{C}$	1,000 Hours	0/20
High Humidity Heat Life Test	JEITA ED-4701 100 102	$T_a = 60^\circ\text{C}, \text{RH} = 90\%, I_F = 20\text{mA}$	500 Hours	0/20
Humidity Heat Load	JEITA ED-4701 100 103	$T_a = 85^\circ\text{C}, \text{RH} = 85\%$	1,000 Hours	0/20
Resistance to Soldering Heat	JEITA ED-4701 301 302	$T_{sld} = 260^\circ\text{C}, 10 \text{ sec}$ pre treatment ; $30^\circ\text{C}, 70\%, 168\text{hrs}$	2 times	0/50
Solder Ability (Reflow Soldering)	JEITA ED-4701 303	$T_{sld} = 215 \pm 5^\circ\text{C}, 3 \text{ sec}$ (Lead Solder)	1 times over 95%	0/50
Temperature Cycle	JEITA ED-4701 100 105	$-40^\circ\text{C} \sim 25^\circ\text{C} \sim 100^\circ\text{C} \sim 25^\circ\text{C}$ (30min) (5min) (30min) (5min)	100 cycle	0/50
Moisture Resistance Cycle	JEITA ED-4701 200 203	$25^\circ\text{C} \sim 65^\circ\text{C} \sim -10^\circ\text{C}$ TH = 90%, 24 hr / 1 cycle	10 cycle	0/50

* Criteria for Judging the Damage

Item	Symbol	Condition	Criteria for Judgement	
			MIN	MAX
Forward Voltage	V_F	$I_F = 20\text{mA}$	-	USL ^{*1} × 1.2
Reverse Current	I_R	$V_R = 5\text{V}$	-	USL × 2.0
Luminous Intensity	I_V	$I_F = 20\text{mA}$	LSL ^{*2} × 0.5	-

Note : *1 USL : Upper Standard Level

*2 LSL : Lower Standard Level

Rev. 1.00

July 2009

www.acriche.com

Document No. : SSC-QP-7-07-24 (Rev.00)

6. Rank of SWBA05

* CIE Chromaticity Diagram

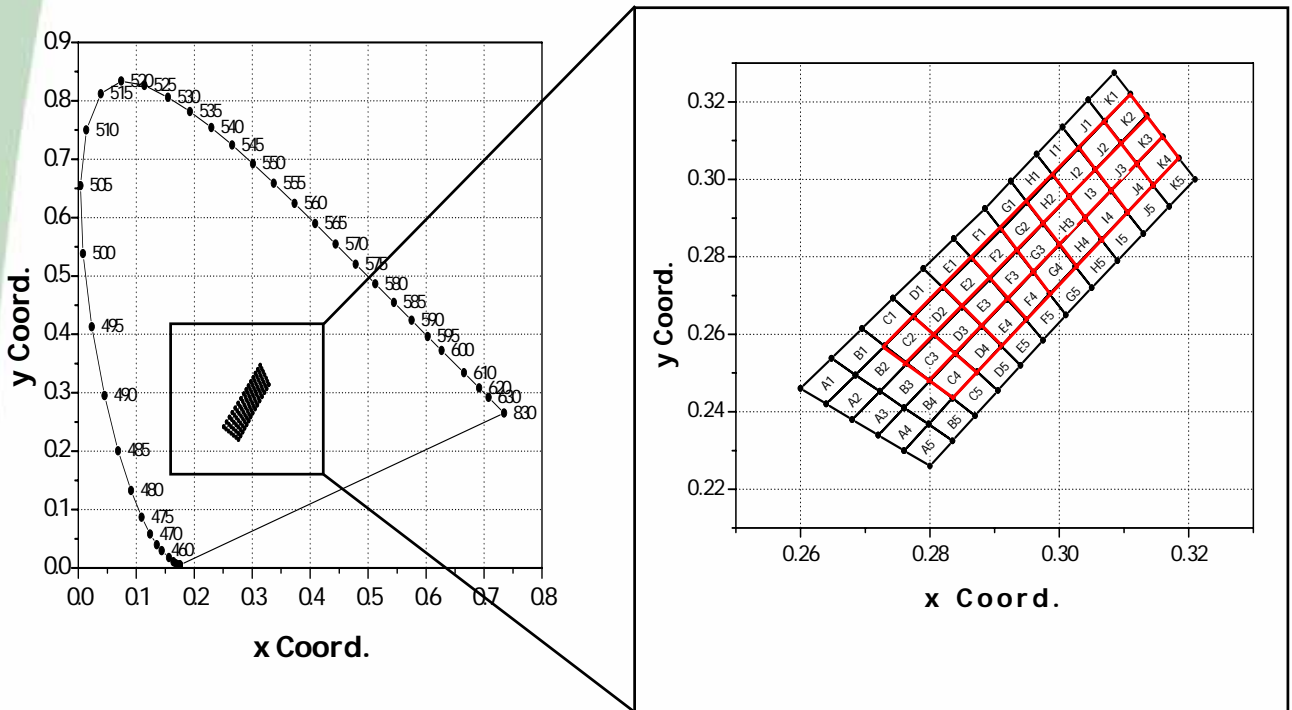

* Color Rank

A1		B1		C1	
x	y	X	y	x	y
0.2600	0.2460	0.2648	0.2538	0.2695	0.2615
0.2648	0.2538	0.2695	0.2615	0.2743	0.2693
0.2685	0.2495	0.2730	0.2570	0.2775	0.2645
0.2640	0.2420	0.2685	0.2495	0.2730	0.2570

D1		E1		F1	
x	y	x	y	x	y
0.2743	0.2693	0.2790	0.2770	0.2837	0.2847
0.2790	0.2770	0.2837	0.2847	0.2885	0.2925
0.2820	0.2720	0.2865	0.2795	0.2910	0.2870
0.2775	0.2645	0.2820	0.2720	0.2865	0.2795



G1		H1		I1	
x	y	x	y	x	y
0.2885	0.2925	0.2925	0.2995	0.2965	0.3065
0.2925	0.2995	0.2965	0.3065	0.3005	0.3135
0.2950	0.2940	0.2990	0.3010	0.3030	0.3080
0.2910	0.2870	0.2950	0.2940	0.2990	0.3010

J1		K1		L1	
x	y	x	y	x	y
0.3005	0.3135	0.3045	0.3205	0.3085	0.3275
0.3045	0.3205	0.3085	0.3275	0.3125	0.3345
0.3070	0.3150	0.3110	0.3220	0.3150	0.3290
0.3030	0.3080	0.3070	0.3150	0.3110	0.3220

A2		B2		C2	
x	y	x	y	x	y
0.2640	0.2420	0.2685	0.2495	0.2730	0.2570
0.2685	0.2495	0.2730	0.2570	0.2765	0.2525
0.2723	0.2453	0.2765	0.2525	0.2808	0.2598
0.2680	0.2380	0.2723	0.2453	0.2775	0.2645

D2		E2		F2	
x	y	x	y	x	y
0.2775	0.2645	0.2820	0.2720	0.2865	0.2795
0.2808	0.2598	0.2865	0.2795	0.2910	0.2870
0.2850	0.2670	0.2893	0.2743	0.2935	0.2815
0.2820	0.2720	0.2850	0.2670	0.2893	0.2743

G2		H2		I2	
x	y	x	y	x	y
0.2910	0.2870	0.2950	0.2940	0.2990	0.3010
0.2950	0.2940	0.2990	0.3010	0.3030	0.3080
0.2975	0.2885	0.3015	0.2955	0.3055	0.3025
0.2935	0.2815	0.2975	0.2885	0.3015	0.2955

J2		K2		L2	
x	y	x	y	x	y
0.3030	0.3080	0.3070	0.3150	0.3110	0.3220
0.3070	0.3150	0.3110	0.3220	0.3150	0.3290
0.3095	0.3095	0.3135	0.3165	0.3175	0.3235
0.3055	0.3025	0.3095	0.3095	0.3135	0.3165

A3		B3		C3	
x	y	x	y	x	y
0.2680	0.2380	0.2723	0.2453	0.2765	0.2525
0.2723	0.2453	0.2765	0.2525	0.2800	0.2480
0.2760	0.2410	0.2800	0.2480	0.2840	0.2550
0.2720	0.2340	0.2760	0.2410	0.2808	0.2598

D3		E3		F3	
x	y	x	y	x	y
0.2808	0.2598	0.3040	0.2900	0.2893	0.2743
0.2840	0.2550	0.3080	0.2970	0.2935	0.2815
0.2880	0.2620	0.3105	0.2915	0.2960	0.2760
0.2850	0.2670	0.3065	0.2845	0.2920	0.2690



G3		H3		I3	
x	y	x	y	x	y
0.2935	0.2815	0.2975	0.2885	0.3015	0.2955
0.2975	0.2885	0.3015	0.2955	0.3055	0.3025
0.3000	0.2830	0.3040	0.2900	0.3080	0.2970
0.2960	0.2760	0.3000	0.2830	0.3040	0.2900

J3		K3		L3	
x	y	x	y	x	y
0.3055	0.3025	0.3095	0.3095	0.3135	0.3165
0.3095	0.3095	0.3135	0.3165	0.3175	0.3235
0.3120	0.3040	0.3160	0.3110	0.3200	0.3180
0.3080	0.2970	0.3120	0.3040	0.3160	0.3110

A4		B4		C4	
x	y	x	y	x	y
0.2720	0.2340	0.2760	0.2410	0.2800	0.2480
0.2760	0.2410	0.2800	0.2480	0.2840	0.2550
0.2798	0.2368	0.2835	0.2435	0.2873	0.2503
0.2760	0.2300	0.2798	0.2368	0.2835	0.2435

D4		E4		F4	
x	y	x	y	x	y
0.2840	0.2550	0.2880	0.2620	0.2920	0.2690
0.2880	0.2620	0.2920	0.2690	0.2960	0.2760
0.2910	0.2570	0.2948	0.2638	0.2985	0.2705
0.2873	0.2503	0.2910	0.2570	0.2948	0.2638

G4		H4		I4	
x	y	x	y	x	y
0.2960	0.2760	0.3000	0.2830	0.3040	0.2900
0.3000	0.2830	0.3040	0.2900	0.3080	0.2970
0.3025	0.2775	0.3065	0.2845	0.3105	0.2915
0.2985	0.2705	0.3025	0.2775	0.3065	0.2845

J4		K4		L4	
x	y	x	y	x	y
0.3080	0.2970	0.3120	0.3040	0.3160	0.3110
0.3120	0.3040	0.3160	0.3110	0.3200	0.3180
0.3145	0.2985	0.3185	0.3055	0.3225	0.3125
0.3105	0.2915	0.3145	0.2985	0.3185	0.3055

* Measurement Uncertainty of the Color Coordinates is ± 0.01

7. Material

Item	Reflector	Wire	Encapsulate	Chip
Material	PPA	Gold	Silicone	GaN

8. Outline Dimension

(Tolerance: ± 0.1 , Unit: mm)

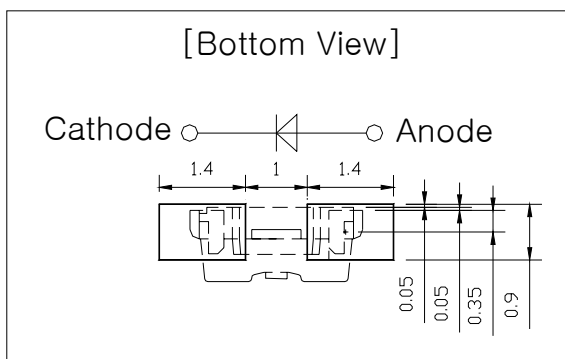
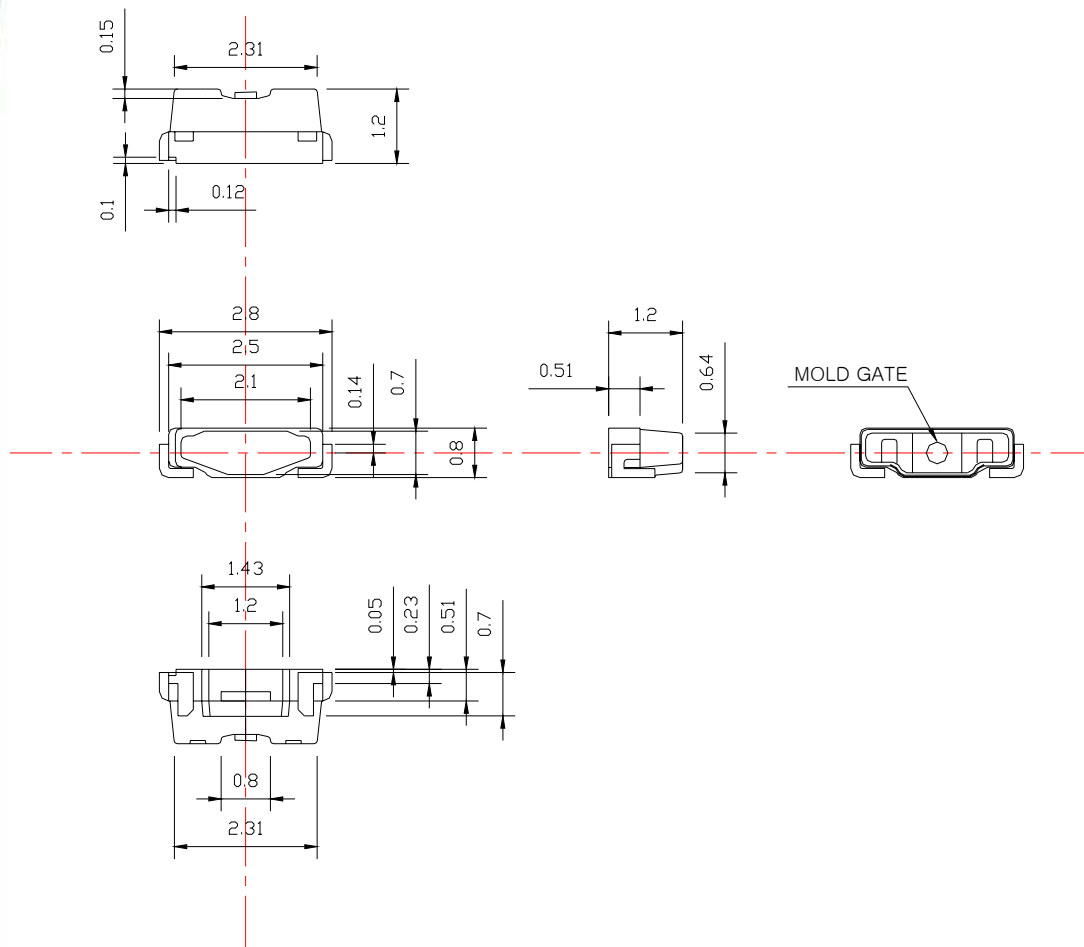

<Recommended solder Pattern>

9. Packing

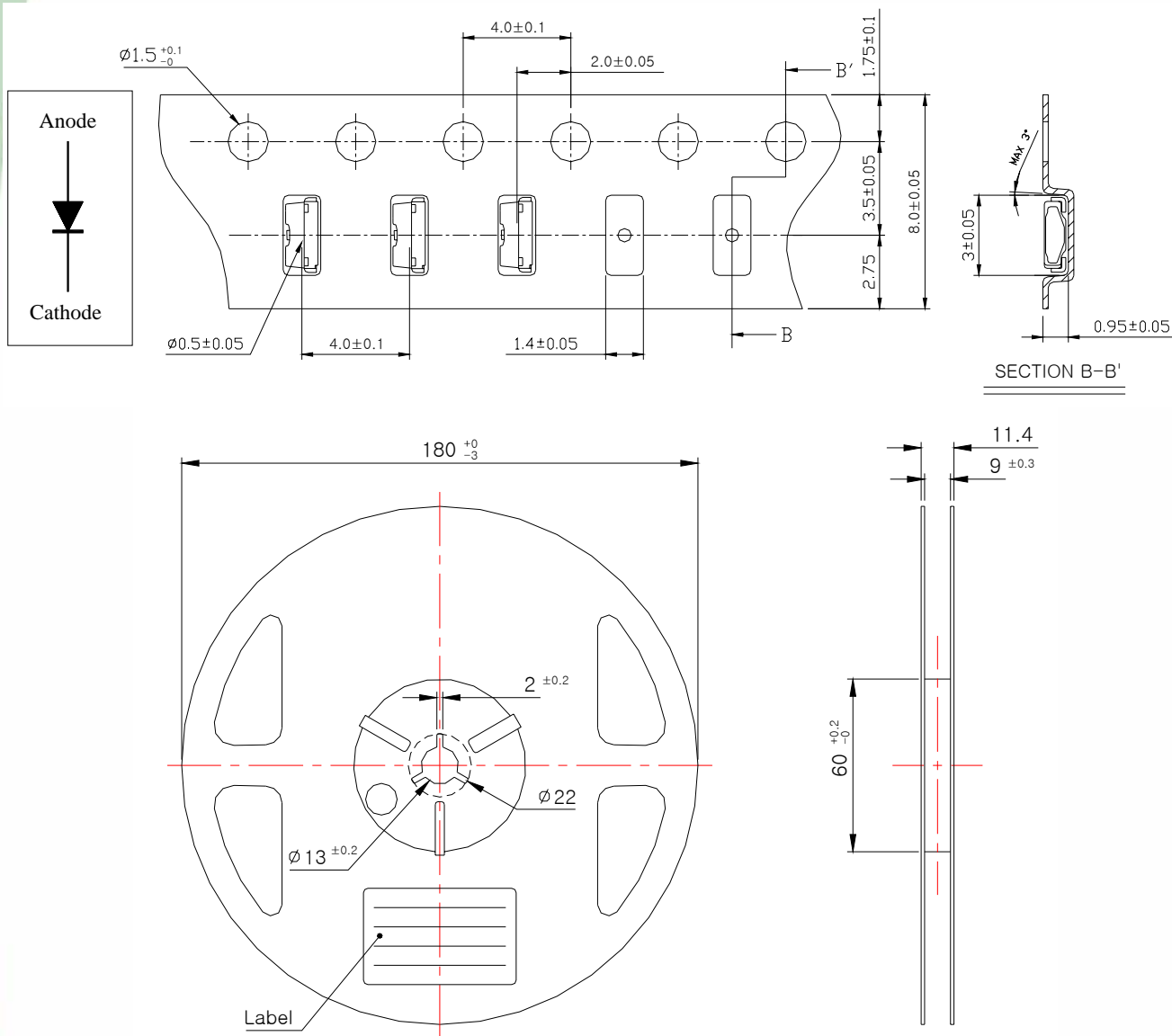

(Tolerance: ±0.2, Unit: mm)

- (1) Quantity : 3500pcs/Reel
- (2) Cumulative Tolerance : Cumulative Tolerance/10 pitches to be ±0.2mm
- (3) Adhesion Strength of Cover Tape : Adhesion strength to be 0.1-0.7N when the cover tape is turned off from the carrier tape at the angle of 10° to the carrier tape
- (4) Package : P/N, Manufacturing data Code No. and quantity to be indicated on a damp proof Package

Rev. 1.00

July 2009

www.acriche.com

Document No. : SSC-QP-7-07-24 (Rev.00)

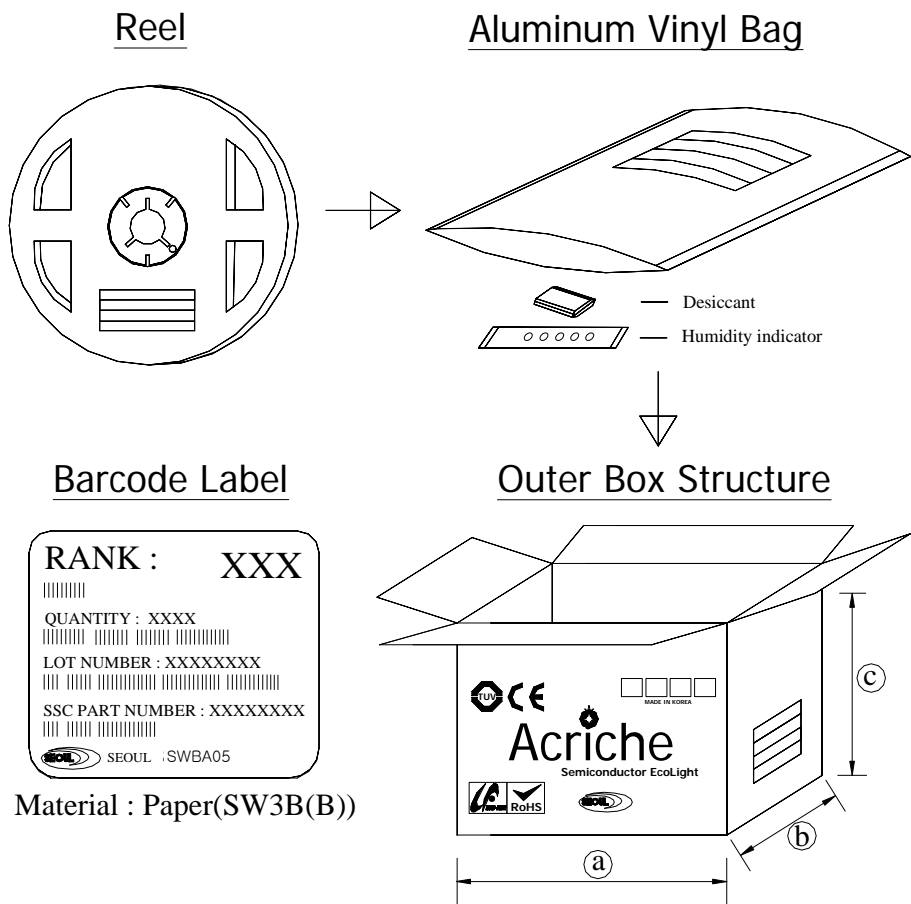

• **Lot Number**

The lot number is composed of the following characters

SWBA05 ○□□◎◎ ◇◇◇

Symbol	Meaning	Example
○	Year	8 for 2008, 9 for 2009, 10 for 2010
□□	Month	01 for Jan., 02 for Feb., 12 for Dec.
◎◎	Day	01, 02, 03, 04, 05, 27, 28, 29, 30, 31
◇◇◇	Number	001, 002, 003, 004, 005, 006, 007

10. Soldering

(1) Lead Solder

Preliminary heating to be at maximum 210°C for maximum 2 minutes.
Soldering heat to be at maximum 240°C for maximum 10 seconds.

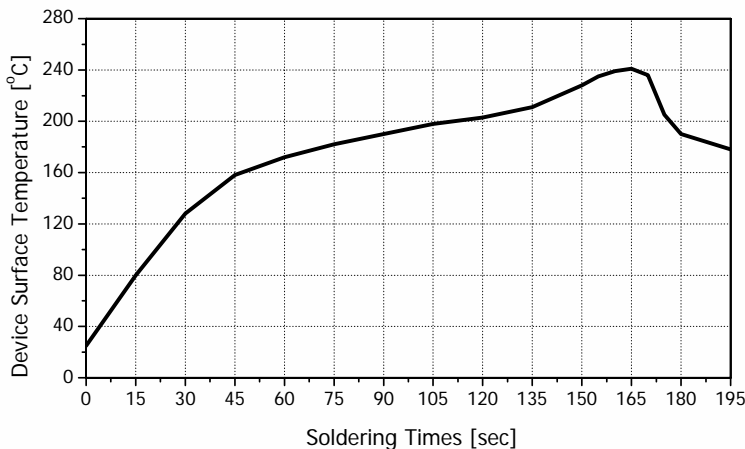

(2) Lead-Free Solder

Preliminary heating to be at maximum 220°C for maximum 2 minutes.
Soldering heat to be at maximum 260°C for maximum 10 seconds.

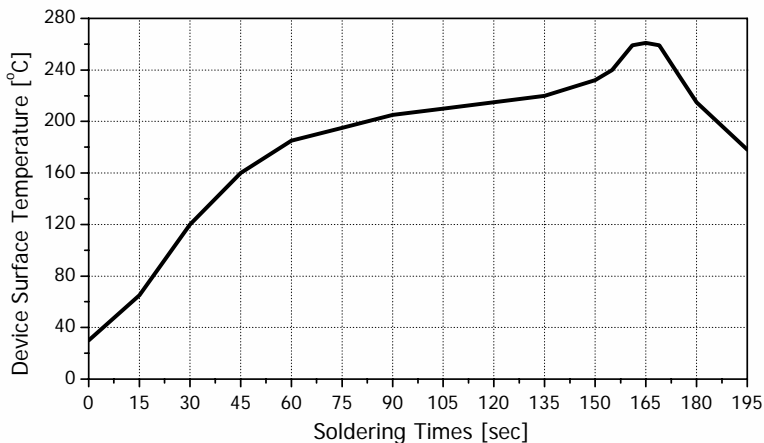

(3) Hand Soldering conditions

Not more than 5 seconds @MAX 300°C, under Soldering iron.

Note : In case that the soldered products are reused in soldering process, we don't guarantee the products.

11. Precaution for Use

(1) Storage conditions

- Keep the product in a dry box or a desiccator with a desiccant in order to prevent moisture absorption.
 - a. Keep it at a temperature in the range from 5°C to 30°C and at a humidity of less than 50% RH.
- In case of being stored for more than 3 months, the product should be sealed with Nitrogen gas.

(2) After opening the package .

- When soldering, this could result in a decrease of the photoelectric effect or light intensity.
 - a. Soldering should be done right after mounting the product.
 - b. Keep the temperature in the range from 5°C to 30°C and the humidity at less than 30%.
- Soldering should be done within 7 days after opening the desiccant package. If the product has been exposed for more than 7 days after opening the package or the indicating color of the desiccator changes, the product must be baked at a temperature between $65 \pm 5^\circ\text{C}$ for 10 to 24 hours.
- An unused and unsealed product should be repacked in a desiccant package and kept sealed in a dry atmosphere.

(3) Precautions for use

- Any external mechanical force or excessive vibration should not be applied to the product during cooling after soldering, and it is preferable to avoid rapid cooling.
- The product should not be mounted on a distorted part of PCB.
- Gloves or wrist bands for ESD(Electric Static Discharge) should be wore in order to prevent ESD and surge damage, and all devices and equipments must be grounded to the earth.

(4) Miscellaneous

- Radiation resistance is not considered.
- When cleaning the product, any kind of fluid such as water, oil and organic solvent must not be used and IPA(Isopropyl Alcohol) must be used.
- When using the product, operating current should be settled in consideration of the maximum ambient temperature.
- Its appearance or specification for improvement is subject to change without notice.