

*Customer:

Pb Free

SPECIFICATION

ITEM	CHIP LED DEVICE
MODEL	THBTGFR421
Revision No.	

[Contents]

1. Features
2. Absolute maximum ratings
3. Electro-optical characteristics
4. Characteristic Diagrams
5. Soldering profile
6. Outline dimension
7. Packing
8. Reel packing structure
9. Rank Division
10. Precaution for use

Customer

Approved by	Approved by	Approved by

Supplier

Drawn by	Checked by	Approved by

1. Features

*Top view type full-color lighting chip LED

*Package : 1.6×1.5×0.5mm, flat molding Type

2. Absolute Maximum Ratings

(Ta=25℃)

Parameter	Symbol	Color	Value	Unit	Remarks
Power Dissipation	P _d	Red	72	mW	
		Green			
		Blue			
Forward Current	I _F	Red	30	mA	*2 1-chip ON *3 3-chip ON
		Green	25 ^{*2} /15 ^{*3}		
		Blue	Per chip		
Peak Forward Current	I _{FM} ^{*1}	Red	50	mA	*1 I _{FM} conditions: Pulse width Tw≤0.1ms, Duty ratio≤1/10
		Green	35		
		Blue			
Reverse Voltage	V _R	5		V	
Operating Temperature	T _{opr}	-30 ~ +85		℃	
Storage Temperature	T _{stg}	-40 ~ +100		℃	

3. Electro-optical Characteristics

(Ta=25℃)

Parameter	Symbol	Condition	Color	Min	Typ	Max	Unit
Forward Voltage	V _F	I _F =10mA	Red	1.7	1.9	2.3	V
			Green	2.7	3.0	3.3	
			Blue	2.7	3.0	3.3	
	V _{Fm}	I _F =1μA	Red	1.3	-	1.8	
			Green	1.8	-	2.7	
			Blue	1.8	-	2.7	
Reverse Current	I _R	V _R =5V	Red	-	0.1	10	μA
Luminous Intensity ^{*2}	I _V	I _F =10mA	Red	50	65	100	mcd
			Green	150	220	290	
			Blue	30	65	85	
Wavelength	λ _d	I _F =10mA	Red	615	625	635	nm
			Green	515	525	535	
			Blue	469	474	479	
Spectral Bandwidth	Δλ	I _F =10mA	Red	-	20	-	nm
			Green	-	35	-	
			Blue	-	25	-	
Viewing angle ^{*3}	2θ _{1/2}	I _F =10mA	Red	-	150	-	°
			Green	-	150	-	
			Blue	-	150	-	

◆ Zener Diode characteristics

Parameter	Condition	Min	Typ	Max	Unit
V _F	I _F =10mA	-	-	1.6	V
I _R	V _R =5V	-	-	1.0	μA

*1 I_{FM} conditions: Pulse width Tw≤0.1ms, Duty ratio≤1/10

*2 The luminous intensity I_V is measured at the peak of the spatial pattern which may not be aligned with the mechanical axis of the LED package.

*3 θ_{1/2} is the off-axis where the luminous intensity is 1/2 the peak intensity.

[Note] All products conform to the listed minimum and maximum specifications for electric and optical characteristics, when operated at 20mA within the maximum ratings shown above. All measurements were made under the standardized environment of SSC.

(Tolerance: V_F±0.1V, I_V±10%, λ_d±2nm)

4. Characteristic Diagrams

Forward Current vs. Forward Voltage

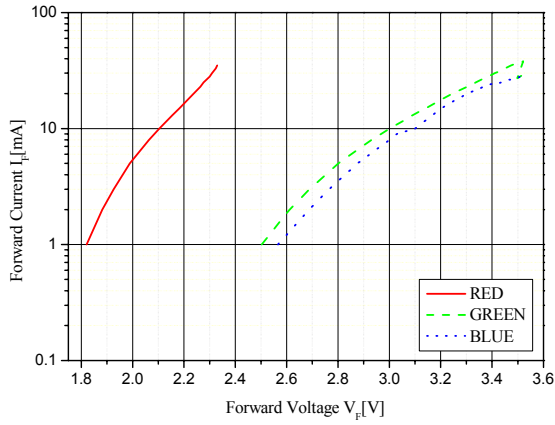

Luminous Intensity vs. Forward Current

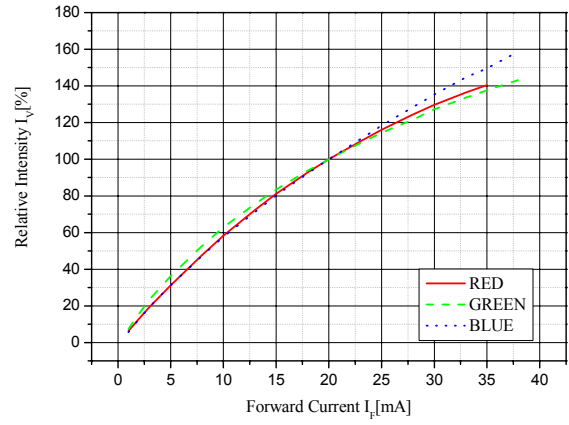

Forward Current Derating Curve

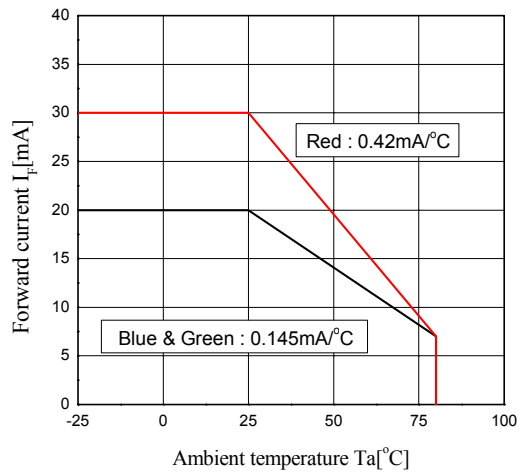

Radiation Diagram

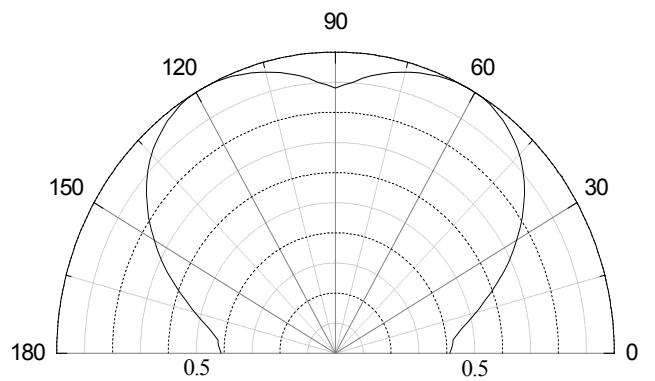

5. Soldering Profile

Reflow Soldering Conditions/ Profile

(1) Lead Solder

- Preliminary heating to be at 150°C max. for 2 minutes max.
- Soldering heat to be at 240°C max. for 5 seconds max.

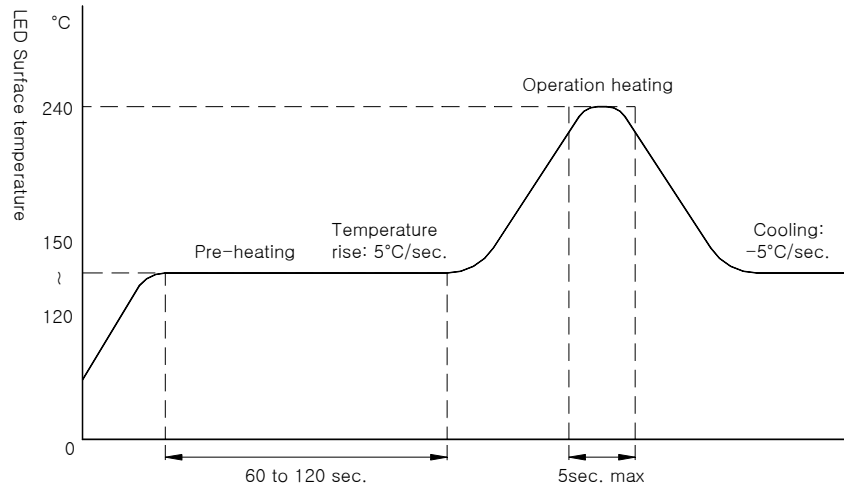

(2) Lead-Free Solder

- Preliminary heating to be at 150°C max. for 2 minutes max.
- Soldering heat to be at 255°C max. for 20 seconds max.

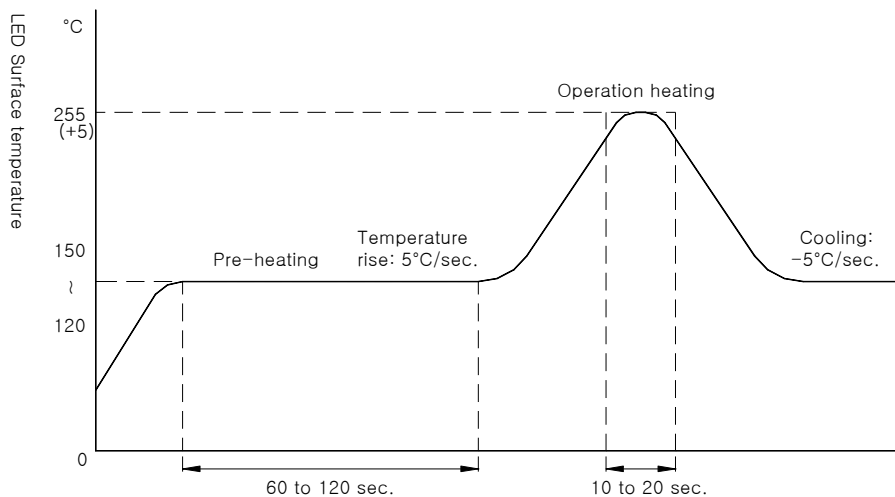

(3) Hand Soldering conditions

- Not more than 3 seconds @MAX280°C, under Soldering iron.

6. Outline Dimension

Tolerance: ± 0.1 , Unit: mm

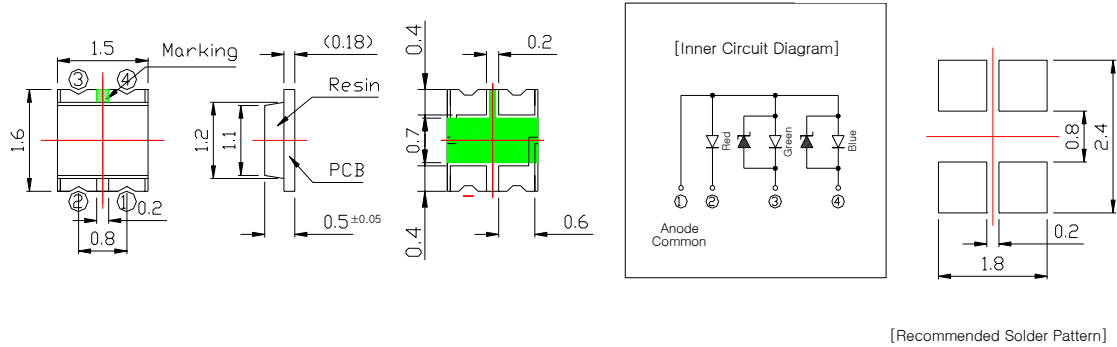

7. Packing

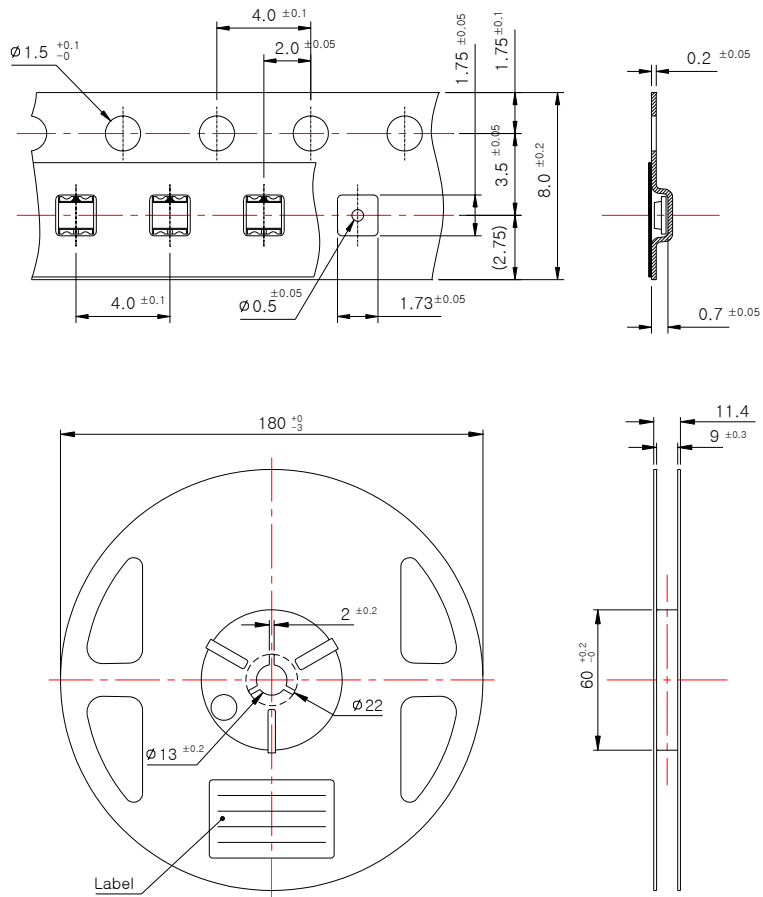

Tolerance: ± 0.2 , Unit: mm

- (1) Quantity : 4000pcs/Reel
- (2) Cumulative Tolerance : Cumulative Tolerance/10pitches to be ± 0.2 mm
- (3) Adhesion Strength of Cover Tape : Adhesion strength to be 0.1-0.7N when the cover tape is turned off from the carrier tape at 10° angle to be the carrier tape.
- (4) Package : P/N, Manufacturing data Code No. and quantity to be indicated on a damp proof Package.

8. Reel Packing Structure

Reel

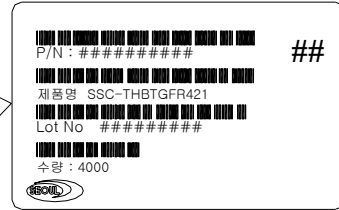
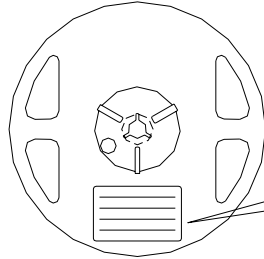

Aluminum Vinyl Bag

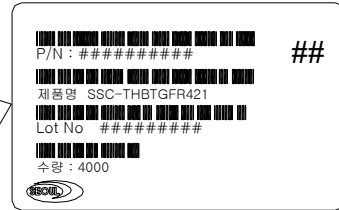
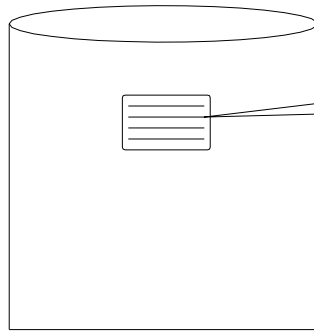

Outer Box

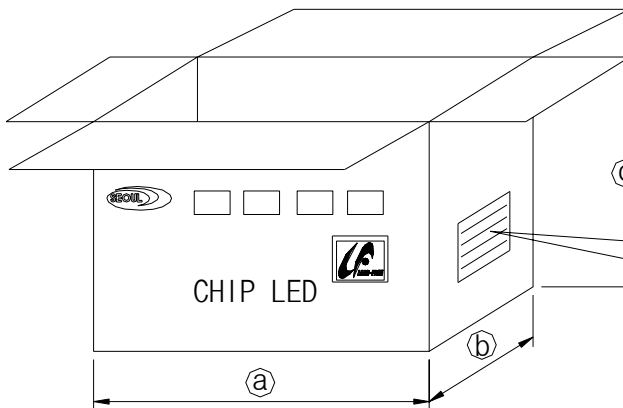

*Material: Paper(SW3B(B))

TYPE	SIZE (mm)		
	Ⓐ	Ⓑ	Ⓒ
7inch	245	220	142

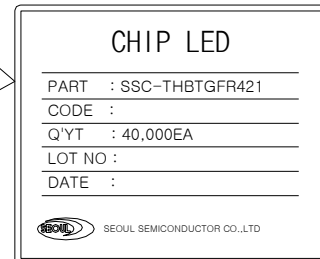

9. Rank Division

V _F [V] (I _F =10mA)			λ _d [nm] (I _F =10mA)			I _V [mcd] (I _F =10mA)			RANK
RED	GREEN	BLUE	RED	GREEN	BLUE	RED	GREEN	BLUE	
1.7~2.3	2.7~2.9	2.7~2.9	615~635	515~535	469~474	50~100	150~290	30~85	A
					474~479	50~100	150~290	30~85	B
		2.9~3.1	615~635	515~535	469~474	50~100	150~290	30~85	C
					474~479	50~100	150~290	30~85	D
		3.1~3.3	615~635	515~535	469~474	50~100	150~290	30~85	E
					474~479	50~100	150~290	30~85	F
	2.9~3.1	2.7~2.9	615~635	515~535	469~474	50~100	150~290	30~85	G
					474~479	50~100	150~290	30~85	H
		2.9~3.1	615~635	515~535	469~474	50~100	150~290	30~85	I
					474~479	50~100	150~290	30~85	J
		3.1~3.3	615~635	515~535	469~474	50~100	150~290	30~85	K
					474~479	50~100	150~290	30~85	L
	3.1~3.3	2.7~2.9	615~635	515~535	469~474	50~100	150~290	30~85	M
					474~479	50~100	150~290	30~85	N
		2.9~3.1	615~635	515~535	469~474	50~100	150~290	30~85	O
					474~479	50~100	150~290	30~85	P
		3.1~3.3	615~635	515~535	469~474	50~100	150~290	30~85	Q
					474~479	50~100	150~290	30~85	R

10. Precaution for use

(1) Storage

In order to avoid the absorption of moisture, it is recommended to store in the dry box (or desiccator) with a desiccant. Otherwise, to store them in the following environment is recommended.

Temperature : 5℃~30℃ Humidity : 60%HR max.

(2) Attention after opened

However LED is corresponded SMD, when LED be soldered dip, interfacial separation may affect the light transmission efficiency, causing the light intensity to drop. Attention in followed.

a. After opened and mounted, the soldering shall be quickly. b. Keeping of a fraction

Temperature : 5 ~ 40℃ Humidity : less than 30%

(3) In case of more than 1 week passed after opening or change color of indicator on desiccant components shall be dried 10-12hr. at 60±5℃.

(4) In case of supposed the components is humid, shall be dried dip-solder just before.

100Hr at 80±5℃ or 12Hr at 100±5℃.

(5) Any mechanical force or any excess vibration shall not be accepted to apply during cooling process to normal temp. after soldering.

(6) Quick cooling shall not be avoid.

(7) Components shall not be mounted on warped direction of PCB.

(8) Anti radioactive ray design is not considered for the products listed here in.

(9) This device should not be used in any type of fluid such as water, oil, organic solvent and etc. When washing is required, IPA should be used.

(10) When the LEDs are illuminating, operating current should be decided after considering the ambient maximum temperature.

(11) LEDs must be stored to maintain a clean atmosphere. If the LEDs are stored for 3 months or more after being shipped from SSC, a sealed container with a nitrogen atmosphere should be used for storage.

(12) The LEDs must be soldered within seven days after opening the moisture-proof packing.

(13) Repack unused products with anti-moisture packing, fold to close any opening and then store in a dry place.

(14) The appearance and specifications of the product may be modified for improvement without notice.

(15) Static Electricity and surge damages the Blue/Green LEDs.

It is recommended to use a wrist band or anti-electrostatic glove when handling the LEDs.

All devices, equipment and machinery must be properly grounded.

(16) It is recommended to use individual resistor separately when the LEDs applies in parallel circuit so that it may improve the light deviations.

(17) It is recommended to examine to the full the circuit by using resistor when the LEDs applies in case of lighting seven colors. (White colour is not available with single LED.)