

SDS52F THRU SDS520F

Surface Mount Schottky Barrier Rectifier
Reverse Voltage - 20 to 200 V
Forward Current - 5 A

SMAF

Features

- Metal silicon junction, majority carrier conduction
- For surface mounted applications
- Low power loss, high efficiency
- High forward surge current capability
- For use in low voltage, high frequency inverters, free wheeling, and polarity protection applications

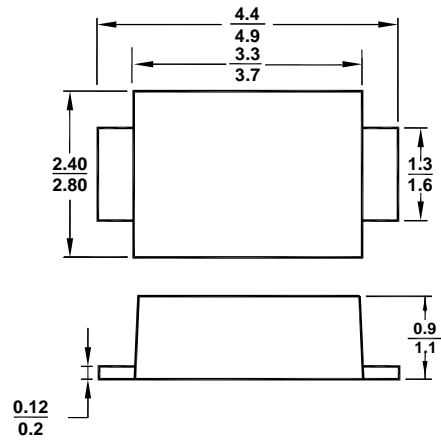

All Dimensions in mm

Maximum Ratings and Electrical Characteristics

Ratings at 25°C ambient temperature unless otherwise specified. Single phase half-wave 60 Hz, resistive or inductive load, for capacitive load current derate by 20%.

Parameter	Symbols	SDS52F	SDS54F	SDS56F	SDS58F	SDS510F	SDS512F	SDS515F	SDS520F	Unit
	Marking	SS52	SS54	SS56	SS58	SS510	SS512	SS515	SS520	-
Maximum Repetitive Peak Reverse Voltage	V_{RRM}	20	40	60	80	100	120	150	200	V
Maximum RMS Voltage	V_{RMS}	14	28	42	56	70	84	105	140	V
Maximum DC Blocking Voltage	V_{DC}	20	40	60	80	100	120	150	200	V
Maximum Average Forward Rectified Current	$I_{F(AV)}$	5								A
Peak Forward Surge Current 8.3 ms Half Sine-wave Superimposed on Rated Load (JEDEC method)	I_{FSM}	150								A
Maximum Instantaneous Forward Voltage at 5 A	V_F	0.45	0.55	0.7		0.85			V	
Maximum DC Reverse Current at Rated DC Blocking Voltage	I_R	1								mA
		50								
Typical Junction Capacitance ¹⁾	C_j	800		500					pF	
Typical Thermal Resistance ²⁾	$R_{\theta JA}$	45								°C/W
Operating Junction Temperature Range	T_j	- 55 to + 125								°C
Storage Temperature Range	T_{stg}	- 55 to + 150								°C

¹⁾ Measured at 1MHz and applied reverse voltage of 4 V D.C.

²⁾ P.C.B. mounted with 0.5 X 0.5" (12.7 X 12.7 mm) copper pad areas.

TOP DYNAMIC



ISO14001 : 2004 Certificate No. 121505007
 ISO 9001 : 2008 Certificate No. 50114012
 OHSAS 18001 : 2007 Certificate No. 05131506006
 IECQ QC 080000 Certificate No. EQS14020141002

Dated: 01/07/2016 JD Rev:02

SDS52F THRU SDS520F

Fig.1 Forward Current Derating Curve

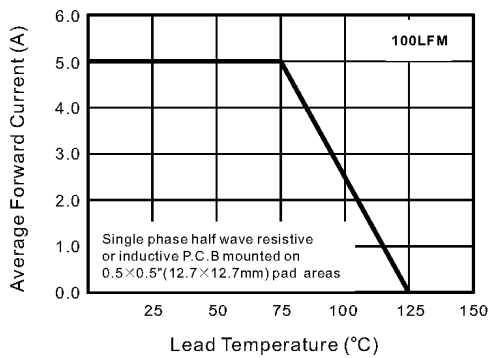

Fig.2 Typical Reverse Characteristics

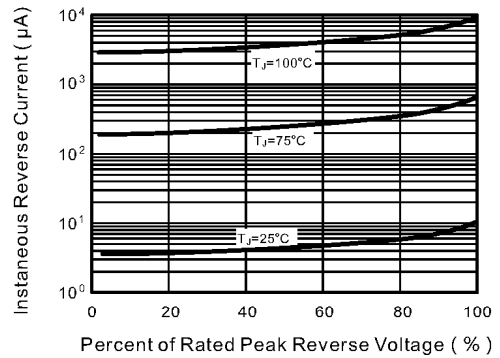

Fig.3 Typical Forward Characteristic

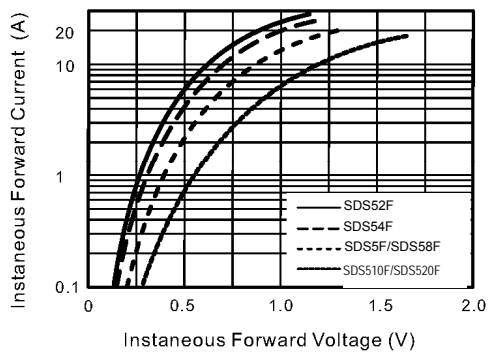

Fig.4 Typical Junction Capacitance

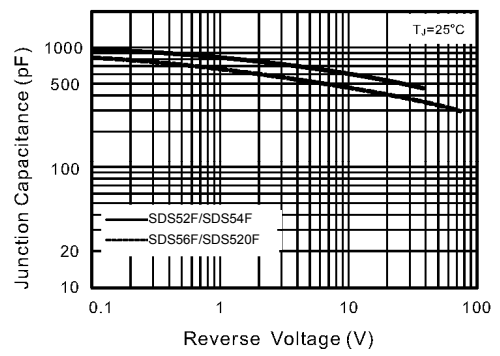

Fig.5 Maximum Non-Repetitive Peak Forward Surge Current

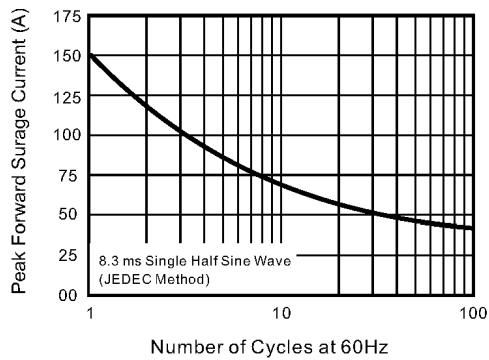
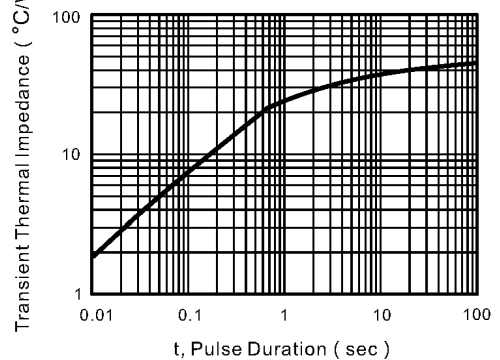

Fig.6- Typical Transient Thermal Impedance



TOP DYNAMIC

