

17 μ A Max, Dual and Quad, Single Supply, Precision Op Amps

FEATURES

- 17 μ A Max Supply Current per Amplifier
- 70 μ V Max Offset Voltage
- 250pA Max Offset Current
- 5nA Max Input Bias Current
- 0.9 μ Vp-p 0.1Hz to 10Hz Voltage Noise
- 1.5pAp-p 0.1Hz to 10Hz Current Noise
- 0.5 μ V/ $^{\circ}$ C Offset Voltage Drift
- 85kHz Gain-Bandwidth-Product
- 0.04V/ μ s Slew Rate
- Single Supply Operation
 - Input Voltage Range Includes Ground
 - Output Swings to Ground while Sinking Current
 - No Pull Down Resistors are Needed
- Output Sources and Sinks 5mA Load Current

APPLICATIONS

- Battery or Solar Powered Systems
 - Portable Instrumentation
 - Remote Sensor Amplifier
 - Satellite Circuitry
- Micropower Sample and Hold
- Thermocouple Amplifier
- Micropower Filters

DESCRIPTION

The LT1178 is a micropower dual op amp in the standard 8-pin configuration; the LT1179 is a micropower quad op amp offered in the standard 14-pin packages. Both devices are optimized for single supply operation at 5V. Specifications are also provided at ± 15 V supplies.

The extremely low supply current is combined with true precision specifications: offset voltage is 30 μ V, offset current is 50pA. Both offset parameters have low drift with temperature. The 1.5pAp-p current noise and picoampere offset current permit the use of megaohm level source resistors without introducing serious errors. Voltage noise, at 0.9 μ Vp-p, is remarkably low considering the low supply current.

Both the LT1178 and LT1179 can be operated from a single supply (as low as one lithium cell or two Ni-cad batteries). The input range goes below ground. The all-NPN output stage swings to within a few millivolts of ground while sinking current—no power consuming pull down resistors are needed.

For applications where three times higher supply current is acceptable, the micropower LT1077 single, LT1078 dual and LT1079 quad are recommended. The LT1077/78/79 have significantly higher bandwidth, slew rate; lower voltage noise and better output drive capability.

Self-Buffered, Dual Output, Micropower Reference

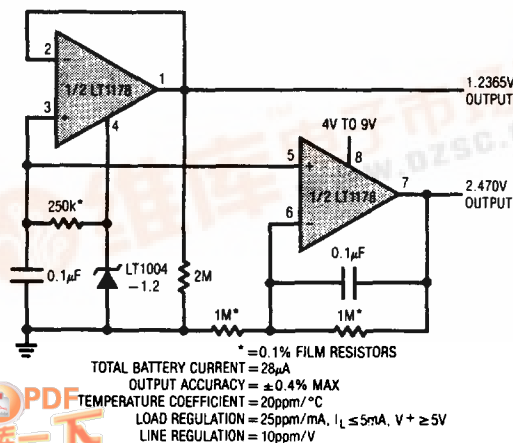

Supply Current vs Temperature

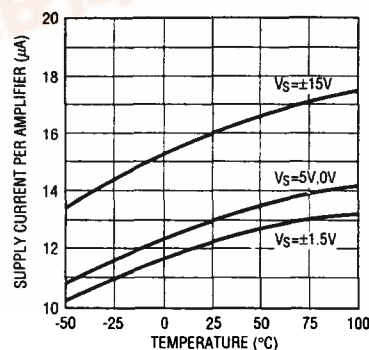

ABSOLUTE MAXIMUM RATINGS

Supply Voltage $\pm 22V$
 Differential Input Voltage $\pm 30V$
 Input Voltage Equal to Positive Supply Voltage
 5V Below Negative Supply Voltage
 Output Short Circuit Duration Indefinite

Operating Temperature Range
 LT1178I/LT1179I $-40^{\circ}C$ to $85^{\circ}C$
 LT1178C/LT1178S/LT1179C/LT1179S $0^{\circ}C$ to $70^{\circ}C$
 Storage Temperature Range $-65^{\circ}C$ to $150^{\circ}C$
 Lead Temperature (Soldering, 10 sec.) $300^{\circ}C$

PACKAGE/ORDER INFORMATION

<p>TOP VIEW V+ OUTPUT A 1 7 OUTPUT B -IN A 2 -IN B +IN A 3 +IN B V- (CASE) H PACKAGE 8-LEAD TO-5 METAL CAN</p>	<p>ORDER PART NUMBER</p> <p>LT1178ACH LT1178CH</p>	<p>TOP VIEW OUTPUT A 1 8 V+ -IN A 2 7 OUTPUT B +IN A 3 6 -IN B V- 4 5 +IN B</p> <p>J PACKAGE 8-LEAD CERAMIC DIP N PACKAGE 8-LEAD PLASTIC DIP</p>	<p>ORDER PART NUMBER</p> <p>LT1178ACJ8 LT1178CJ8 LT1178ACN8 LT1178CN8 LT1178IN8</p>	<p>TOP VIEW OUTPUT A 1 14 OUTPUT D -IN A 2 13 -IN D +IN A 3 12 +IN D V+ 4 11 V- +IN B 5 10 +IN C -IN B 6 9 -IN C OUTPUT B 7 8 OUTPUT C</p> <p>J PACKAGE 14-LEAD CERAMIC DIP N PACKAGE 14-LEAD PLASTIC DIP</p>	<p>ORDER PART NUMBER</p> <p>LT1179ACJ LT1179CJ LT1179ACN LT1179CN LT1179IN</p>
<p>TOP VIEW NC 1 16 NC NC 2 15 NC OUTPUT A 3 14 V+ -IN A 4 13 OUTPUT B +IN A 5 12 -IN B V- 6 11 +IN B NC 7 10 NC NC 8 9 NC</p> <p>S PACKAGE 16-LEAD PLASTIC SOL</p>	<p>ORDER PART NUMBER</p> <p>LT1178S</p>	<p>TOP VIEW OUTPUT A 1 16 OUTPUT D -IN A 2 15 -IN D +IN A 3 14 +IN D V+ 4 13 V- +IN B 5 12 +IN C -IN B 6 11 -IN C OUTPUT B 7 10 OUTPUT C NC 8 9 NC</p> <p>S PACKAGE 16-LEAD PLASTIC SOL</p>	<p>ORDER PART NUMBER</p> <p>LT1179S</p>		

2

ELECTRICAL CHARACTERISTICS $V_S = 5V, 0V, V_{CM} = 0.1V, V_O = 1.4V, T_A = 25^{\circ}C$, unless noted.

SYMBOL	PARAMETER	CONDITIONS (NOTE 1)	LT1178AC/1179AC			LT1178I/C/S/1179I/C/S			UNITS
			MIN	TYP	MAX	MIN	TYP	MAX	
V_{OS}	Input Offset Voltage	LT1178 LT1179 LT1178S LT1179S	30 35	70 100		40 40 80 90	120 150 450 600	μV μV μV μV	
$\frac{\Delta V_{OS}}{\Delta Time}$	Long Term Input Offset Voltage Stability		0.5			0.6			$\mu V/Mo$
I_{OS}	Input Offset Current		0.05	0.25		0.05	0.35	nA	
I_B	Input Bias Current		3	5		3	6	nA	
e_n	Input Noise Voltage	0.1Hz to 10Hz (Note 2)	0.9	2.0		0.9		μV_{p-p}	
	Input Noise Voltage Density	$f_o = 10Hz$ (Note 2) $f_o = 1000Hz$ (Note 2)	50 49	75 65		50 49		nV/\sqrt{Hz} nV/\sqrt{Hz}	
i_n	Input Noise Current	0.1Hz to 10Hz (Note 2)	1.5	2.5		1.5		pA_{p-p}	
	Input Noise Current Density	$f_o = 10Hz$ (Note 2) $f_o = 1000Hz$	0.03 0.01	0.07		0.03 0.01		pA/\sqrt{Hz} pA/\sqrt{Hz}	
	Input Resistance Differential Mode Common-Mode	(Note 3)	0.8	2.0 12		0.6	2.0 12	$G\Omega$ $G\Omega$	
	Input Voltage Range		3.5 0	3.9 -0.3		3.5 0	3.9 -0.3	V V	
CMRR	Common-Mode Rejection Ratio	$V_{CM} = 0V$ to $3.5V$	93	103		90	102	dB	
PSRR	Power Supply Rejection Ratio	$V_S = 2.2V$ to $12V$	94	104		92	104	dB	

LT1178/LT1179

ELECTRICAL CHARACTERISTICS $V_S = 5V, 0V, V_{CM} = 0.1V, V_O = 1.4V, T_A = 25^\circ C$, unless noted.

SYMBOL	PARAMETER	CONDITIONS (NOTE 1)	LT1178AC/1179AC			LT1178I/C/S/1179I/C/S			UNITS	
			MIN	TYP	MAX	MIN	TYP	MAX		
A _{VOL}	Large Signal Voltage Gain	V _O = 0.03V to 4V, No Load (Note 3)	140	700		110	700		V/mV	
		V _O = 0.03V to 3.5V, R _L = 50k	80	200		70	200		V/mV	
	Maximum Output Voltage Swing	Output Low, No Load		6.5	9		6.5	9	mV	
		Output Low, 2k to GND		0.2	0.6		0.2	0.6	mV	
		Output Low, I _{SINK} = 100μA		120	160		120	160	mV	
		Output High, No Load	4.2	4.4		4.2	4.4		V	
		Output High, 2k to GND	3.5	3.8		3.5	3.8		V	
SR	Slew Rate	A _V = +1, C _L = 10pF (Note 3)	0.013	0.025		0.013	0.025		V/μs	
GBW	Gain Bandwidth Product	f _o ≤ 5kHz		60		60			kHz	
I _S	Supply Current per Amplifier	V _S = ±1.5V, V _O = 0V		13	18		14	21		μA
				12	17		13	20		μA
	Channel Separation	ΔV _{IN} = 3V, R _L = 10k		130		130				dB
	Minimum Supply Voltage	(Note 4)		2.0	2.2		2.0	2.2		V

ELECTRICAL CHARACTERISTICS $V_S = 5V, 0V, V_{CM} = 0.1V, V_O = 1.4V, -40^\circ C \leq T_A \leq 85^\circ C$ for I grades, $0^\circ C \leq T_A \leq 70^\circ C$ for S grades, unless noted. (Note 6)

SYMBOL	PARAMETER	CONDITIONS		LT1178I/1179I			LT1178S/1179S			UNITS	
				MIN	TYP	MAX	MIN	TYP	MAX		
V _{OS}	Input Offset Voltage	LT1178	●	80	315		120	650		μV	
		LT1179	●	80	345		130	800		μV	
ΔV _{OS} /ΔT	Input Offset Voltage Drift	(Note 5)	●	0.6	3.0		0.8	4.5		μV/°C	
I _{OS}	Input Offset Current		●	0.07	0.7		0.06	0.50		nA	
I _B	Input Bias Current		●	4	8		3	7		nA	
CMRR	Common-Mode Rejection Ratio	V _{CM} = 0.05V to 3.2V I grade V _{CM} = 0V to 3.4V S grade	●	84	98		86	100		dB	
PSRR	Power Supply Rejection Ratio	V _S = 3.0V to 12V I grade V _S = 2.5V to 12V S grade	●	86	100		88	102		dB	
A _{VOL}	Large Signal Voltage Gain	V _O = 0.05V to 4V, No Load (Note 3)	●	55	350		80	500		V/mV	
		V _O = 0.05V to 3.5V, R _L = 50k	●	35	130		45	160		V/mV	
	Maximum Output Voltage Swing	Output Low, No Load	●		9	13		8	11		mV
		Output Low, I _{SINK} = 100μA	●		160	220		140	190		mV
		Output High, No Load	●	3.9	4.2		4.1	4.3			V
		Output High, 2k to GND	●	3.0	3.7		3.3	3.8			V
I _S	Supply Current per Amplifier		●	15	27		15	24		μA	

ELECTRICAL CHARACTERISTICS $V_S = 5V, 0V, V_{CM} = 0.1V, V_O = 1.4V, 0^\circ C \leq T_A \leq 70^\circ C$, unless noted.

SYMBOL	PARAMETER	CONDITIONS		LT1178AC/1179AC			LT1178C/1179C			UNITS	
				MIN	TYP	MAX	MIN	TYP	MAX		
V _{OS}	Input Offset Voltage	LT1178	●	50	170		65	250		μV	
		LT1179	●	60	200		70	290		μV	
ΔV _{OS} /ΔT	Input Offset Voltage Drift	(Note 5)	●	0.5	2.2		0.6	3.0		μV/°C	
I _{OS}	Input Offset Current		●	0.06	0.35		0.06	0.50		nA	
I _B	Input Bias Current		●	3	6		3	7		nA	
CMRR	Common-Mode Rejection Ratio	V _{CM} = 0V to 3.4V	●	90	101		86	100		dB	
PSRR	Power Supply Rejection Ratio	V _S = 2.5V to 12V	●	90	102		88	102		dB	
A _{VOL}	Large Signal Voltage Gain	V _O = 0.05V to 4V, No Load (Note 3)	●	105	500		80	500		V/mV	
		V _O = 0.05V to 3.5V, R _L = 50k	●	55	160		45	160		V/mV	
	Maximum Output Voltage Swing	Output Low, No Load	●		8	11		8	11		mV
		Output Low, I _{SINK} = 100μA	●		140	190		140	190		mV
		Output High, No Load	●	4.1	4.3		4.1	4.3			V
		Output High, 2k to GND	●	3.3	3.8		3.3	3.8			V
I _S	Supply Current per Amplifier		●	14	21		15	24		μA	

ELECTRICAL CHARACTERISTICS $V_S = \pm 15V, T_A = 25^\circ C$, unless noted.

SYMBOL	PARAMETER	CONDITIONS	LT1178AC/1179AC			LT1178I/C/S/1179I/C/S			UNITS
			MIN	TYP	MAX	MIN	TYP	MAX	
V_{OS}	Input Offset Voltage	LT1178S LT1179S		80	350		100	480	μV
							150	900	μV
							160	1050	μV
I_{OS}	Input Offset Current			0.05	0.25		0.05	0.35	nA
I_B	Input Bias Current			3	5		3	6	nA
	Input Voltage Range		13.5	13.9		13.5	13.9		V
			-15.0	-15.3		-15.0	-15.3		V
CMRR	Common-Mode Rejection Ratio	$V_{CM} + 13.5V, -15V$	97	106		94	106		dB
PSRR	Power Supply Rejection Ratio	$V_S = 5V, 0V$ to $\pm 18V$	96	112		94	112		dB
A_{VOL}	Large Signal Voltage Gain	$V_O = \pm 10V, R_L = 50k$	300	1200		250	1000		V/mV
		$V_O = \pm 10V$, No Load	600	2500		400	2500		V/mV
V_{OUT}	Maximum Output Voltage Swing	$R_L = 50k$	± 13.0	± 14.2		± 13.0	± 14.2		V
		$R_L = 2k$	± 11.0	± 12.7		± 11.0	± 12.7		V
SR	Slew Rate	$A_V = +1$	0.02	0.04		0.02	0.04		V/ μs
GBW	Gain Bandwidth Product	$f_O \leq 5kHz$		85			85		KHz
I_S	Supply Current per Amplifier			16	21		17	25	μA

ELECTRICAL CHARACTERISTICS $V_S = \pm 15V, -40^\circ C \leq T_A \leq 85^\circ C$ for I grades, $0^\circ C \leq T_A \leq 70^\circ C$ for S grades, unless noted.

SYMBOL	PARAMETER	CONDITIONS	LT1178I/1179I			LT1178S/1179S			UNITS
			MIN	TYP	MAX	MIN	TYP	MAX	
V_{OS}	Input Offset Voltage	LT1178	●	130	740		190	1150	μV
		LT1179	●	130	740		200	1300	μV
$\Delta V_{OS}/\Delta T$	Input Offset Voltage Drift	(Note 5)	●	0.7	4.0		0.9	5.5	$\mu V/^\circ C$
I_{OS}	Input Offset Current		●	0.07	0.7		0.06	0.35	nA
I_B	Input Bias Current		●	4	8		3	7	nA
A_{VOL}	Large Signal Voltage Gain	$V_O = \pm 10V, R_L = 50k$	●	100	500		150	750	V/mV
CMRR	Common-Mode Rejection Ratio	$V_{CM} = +13V, -14.9V$	●	88	103		91	104	dB
PSRR	Power Supply Rejection Ratio	$V_S = 5V, 0V$ to $\pm 18V$	●	88	109		91	110	dB
	Maximum Output Voltage Swing	$R_L = 5k$	●	± 11.0	± 13.5		± 11.0	± 13.5	V
I_S	Supply Current per Amplifier		●	19	30		18	28	μA

ELECTRICAL CHARACTERISTICS $V_S = \pm 15V, 0^\circ C \leq T_A \leq 70^\circ C$, unless noted.

SYMBOL	PARAMETER	CONDITIONS	LT1178AC/1179AC			LT1178C/1179C			UNITS
			MIN	TYP	MAX	MIN	TYP	MAX	
V_{OS}	Input Offset Voltage		●	100	480		130	660	μV
$\Delta V_{OS}/\Delta T$	Input Offset Voltage Drift	(Note 5)	●	0.6	2.8		0.7	4.0	$\mu V/^\circ C$
I_{OS}	Input Offset Current		●	0.06	0.35		0.06	0.35	nA
I_B	Input Bias Current		●	3	6		3	7	nA
A_{VOL}	Large Signal Voltage Gain	$V_O = \pm 10V, R_L = 50k$	●	200	800		150	750	V/mV
CMRR	Common-Mode Rejection Ratio	$V_{CM} = 13V, -15V$	●	94	104		91	104	dB
PSRR	Power Supply Rejection Ratio	$V_S = 5V, 0V$ to $\pm 18V$	●	93	110		91	110	dB
	Maximum Output Voltage Swing	$R_L = 5k$	●	± 11.0	± 13.6		± 11.0	± 13.6	V
I_S	Supply Current per Amplifier		●	17	24		18	28	μA

The ● denotes the specifications which apply over the full operating temperature range.

Note 1: Typical parameters are defined as the 60% yield of parameter distributions of individual amplifiers; i.e., out of 100 LT1179s (or 100 LT1178s) typically 240 op amps (or 120) will be better than the indicated specification.

Note 2: This parameter is tested on a sample basis only. All noise parameters are tested with $V_S = \pm 2.5, V_O = 0V$.

Note 3: This parameter is guaranteed by design and is not tested.

Note 4: Power supply rejection ratio is measured at the minimum supply voltage. The op amps actually work at 1.7V supply but with a typical offset skew of $-300\mu V$.

Note 5: This parameter is not 100% tested.

Note 6: During testing at $-40^\circ C$, the 5V power supply turn on time is less than 0.5 seconds.

TYPICAL PERFORMANCE CHARACTERISTICS

**Input Offset Voltage Distribution
N, J, H Package**

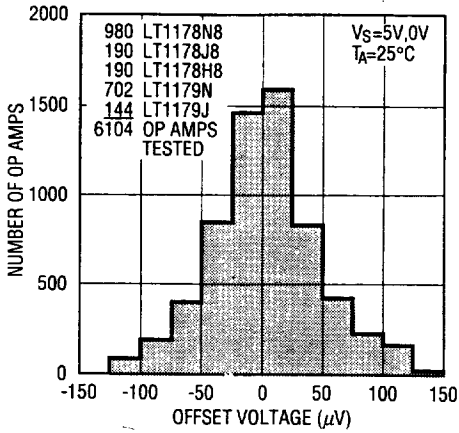

**Input Offset Voltage Distribution
Surface Mount Package**

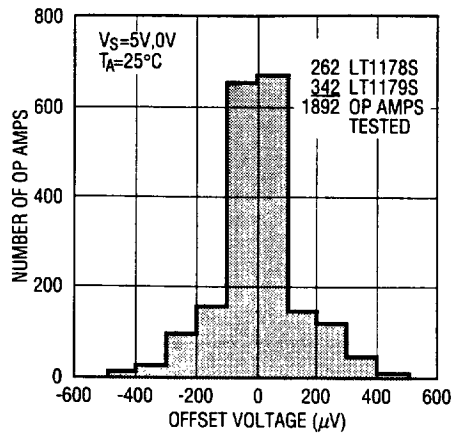

Minimum Supply Voltage

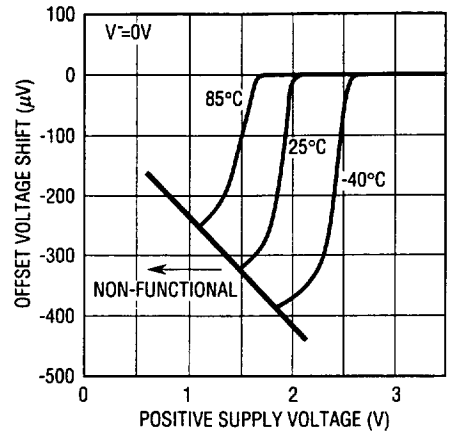

**Input Bias and Offset Currents vs
Temperature**

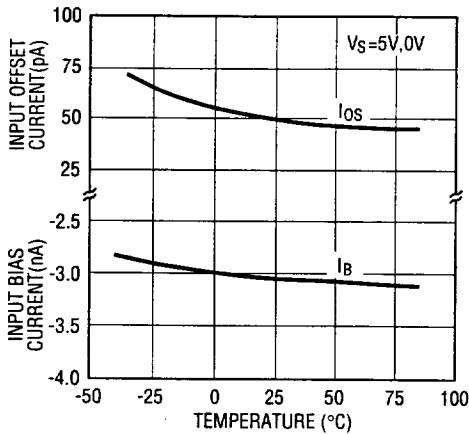

**Output Saturation vs Temperature
vs Sink Current**

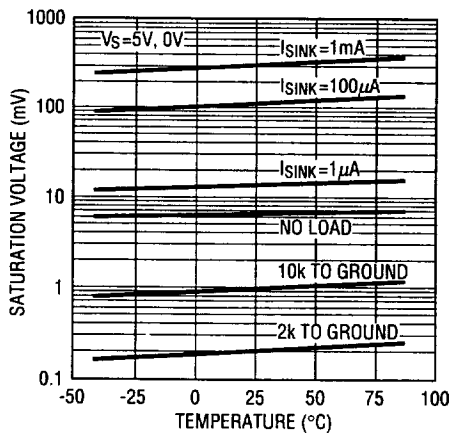

Short Circuit Current

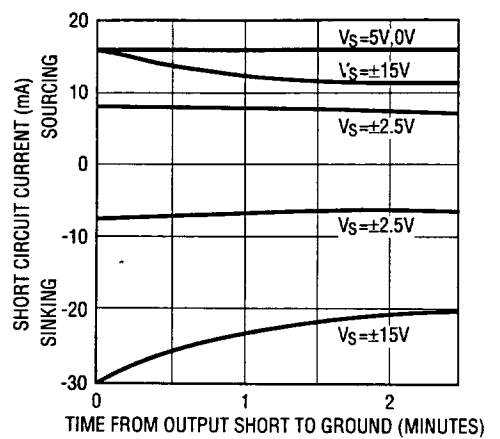

0.1Hz to 10Hz Noise

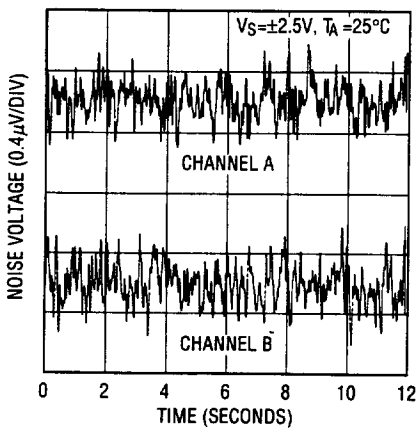

0.01Hz to 10Hz Noise

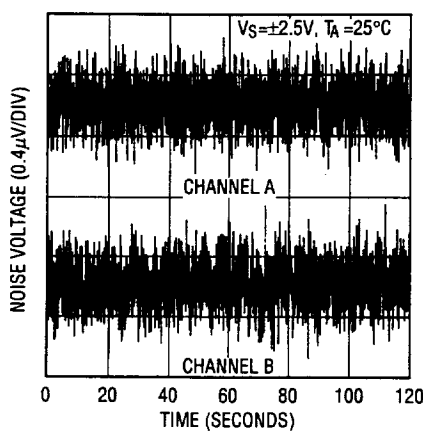

Noise Spectrum

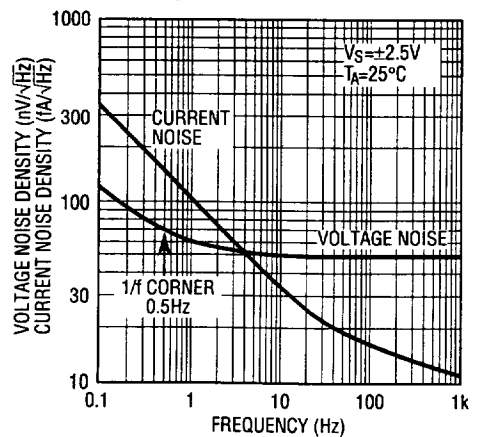

TYPICAL PERFORMANCE CHARACTERISTICS

Voltage Gain vs Frequency

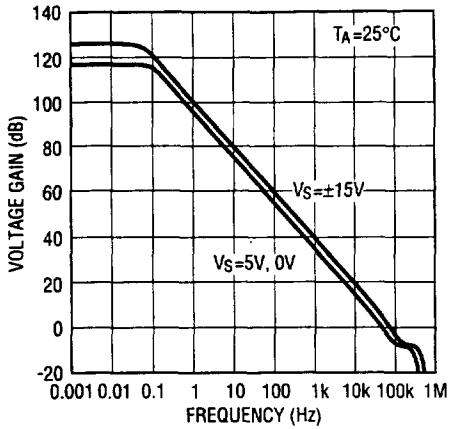

Gain, Phase vs Frequency

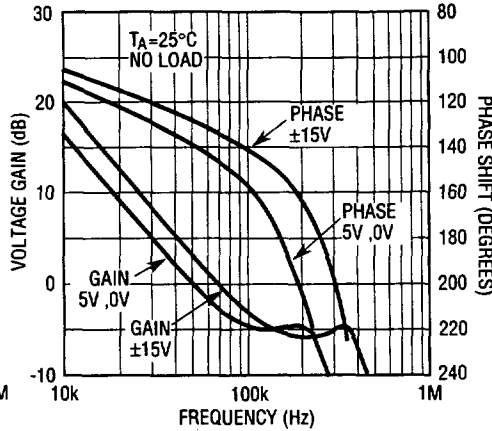

Voltage Gain vs Load Resistance

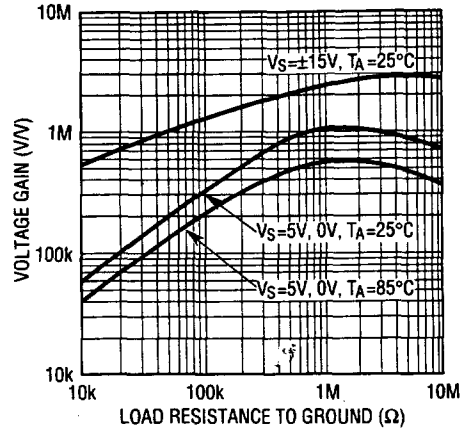

2

Capacitive Load Handling

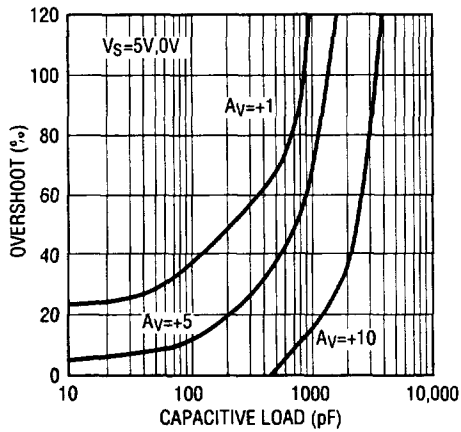

**Large Signal Transient Response
VS = ±15V**

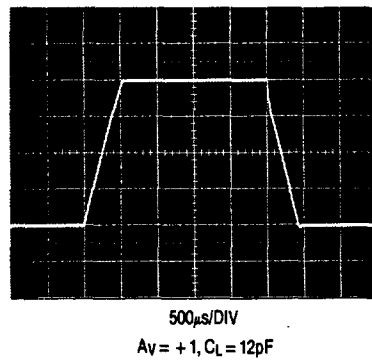

**Large Signal Transient Response
VS = 5V, 0V**

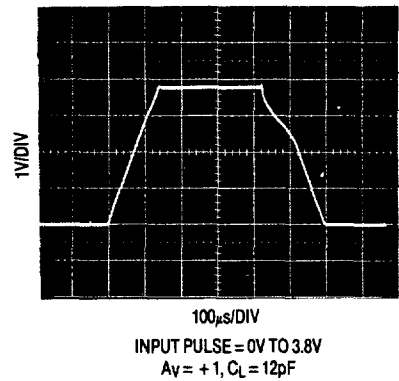

**Small Signal Transient Response
VS = ±2.5V**

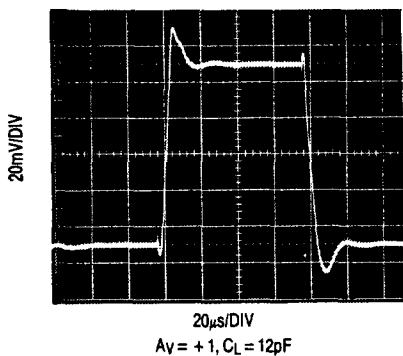

**Small Signal Transient Response
VS = ±15V**

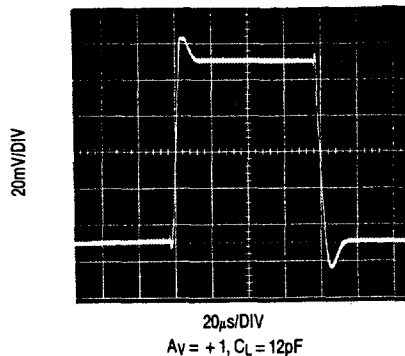

**Small Signal Transient Response
VS = 5V, 0V**

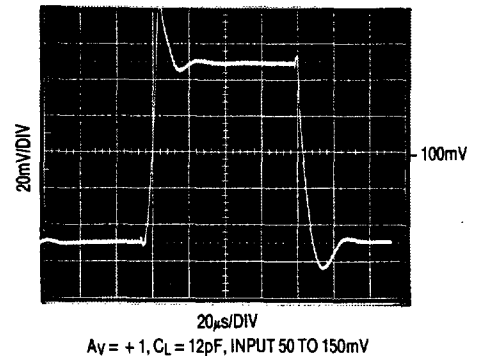

TYPICAL PERFORMANCE CHARACTERISTICS

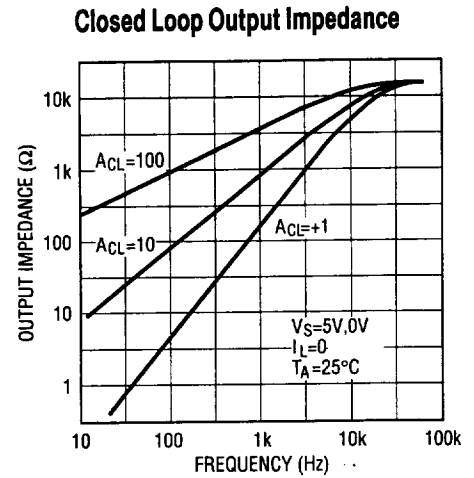
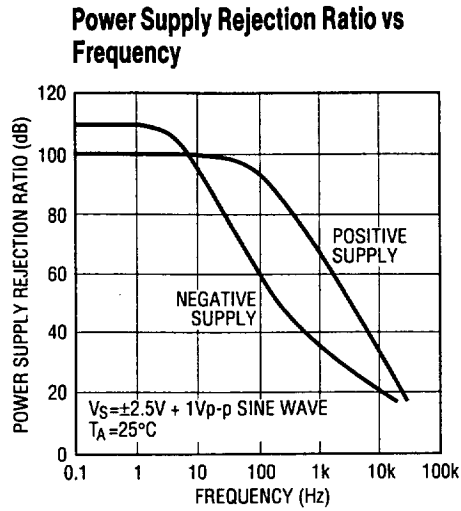
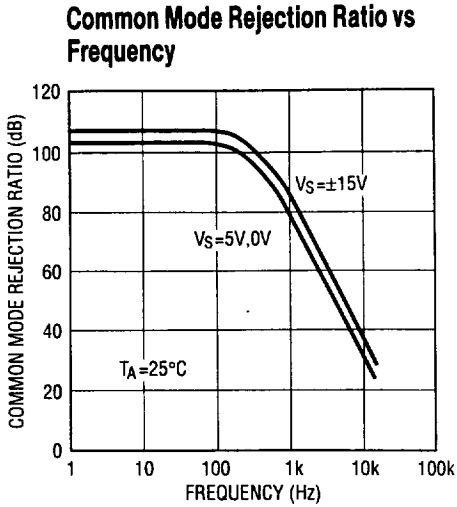

APPLICATIONS INFORMATION

Please see the LT1078/LT1079 data sheet for applications information. All comments relating to specifications,

single supply operation and phase reversal protection are directly applicable to the LT1178/LT1179.

Micropower 100Hz to 1MHz V-to-F Converter

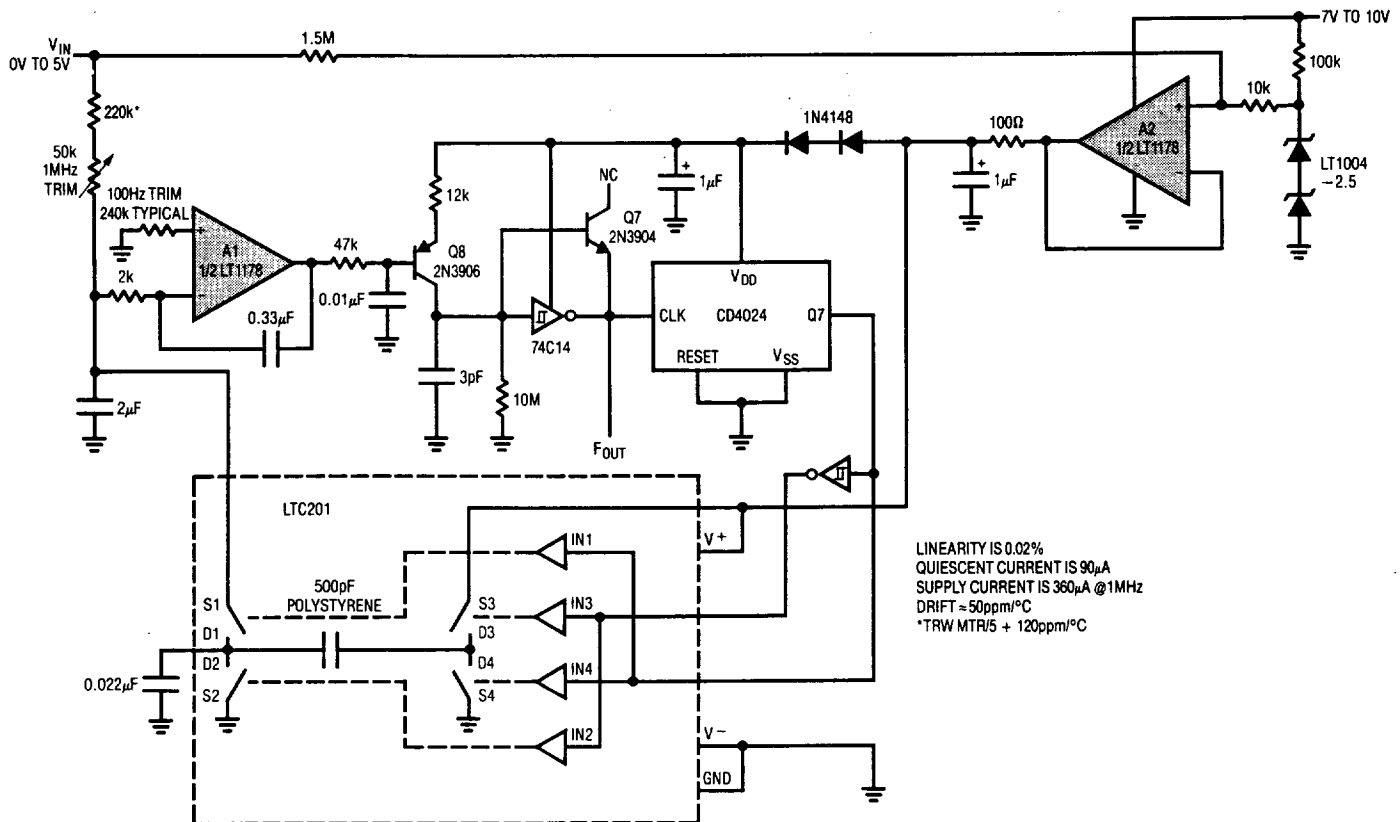

SIMPLIFIED SCHEMATIC

1/2 LT1178
1/4 LT1179

