

# NEC

## 8-PIN SOP, SLOW SWITCHING TYPE, 260 V BREAK DOWN VOLTAGE 2-CH OPTICAL COUPLED MOS FET

PS7622A-2A

### FEATURES

- **2 CHANNEL TYPE**  
1a + 1a output
- **LOW LED OPERATING CURRENT**  
 $I_F = 1 \text{ mA}$
- **DESIGNED FOR AC/DC SWITCHING LINE CHANGER**
- **SMALL AND THIN PACKAGE**  
8-pin SOP, Height = 2.1 mm
- **LOW OFFSET VOLTAGE**
- **ORDERING NUMBER OF TAPING PRODUCT**  
PS7622A-2A-F3,F4

### DESCRIPTION

The PS7622-2A is a solid state relay containing GaAs LEDs on light emitting side (input side) and MOS FETs on the output side.

It is suitable for analog signal control because of its low offset and high linearity.

### APPLICATIONS

- EXCHANGE EQUIPMENT (FAX, MODEM, OCU + SLIC, ETC.)
- MEASUREMENT EQUIPMENT
- FA/OA EQUIPMENT

### ELECTRICAL CHARACTERISTICS<sup>1</sup> ( $T_A = 25^\circ\text{C}$ )

SYMBOL		PART NUMBER	PARAMETERS	UNITS	PS7622A-2A		
					MIN	TYP	MAX
Diode	$V_F$		Forward Voltage, $I_F = 1.4 \text{ mA}$	V		1.2	1.4
	$I_R$		Reverse Current, $V_R = 5 \text{ V}$	$\mu\text{A}$			5.0
MOS FET	$I_{\text{LOFF}}$		Off-state Leakage Current, $V_D = 260 \text{ V}$	$\mu\text{A}$			1.0
	$C_{\text{OUT}}$		Output Capacitance, $V_D = 0 \text{ V}$ , $f = 1 \text{ MHz}$	pF/ch		122	
Coupled	$I_{\text{FON}}$		LED On-state Current, $I_L = 200 \text{ mA}$	mA			1.0
	$R_{\text{ON}}$		On-state Resistance, $I_F = 1.4 \text{ mA}$ , $I_L = 10 \text{ mA}$	$\Omega$		3.5	5.0
	$T_{\text{ON}}$		Turn-on Time <sup>1</sup> , $I_F = 1.4 \text{ mA}$ , $V_0 = 60 \text{ V}$ , $R_L = 1.5 \text{ k}\Omega$ , $PW = 50 \text{ ms}$	ms		10	20
	$T_{\text{OFF}}$		Turn-off Time <sup>1</sup> , $I_F = 1.4 \text{ mA}$ , $V_0 = 60 \text{ V}$ , $R_L = 1.5 \text{ k}\Omega$ , $PW = 50 \text{ ms}$	ms		7.0	12
	$T_R$		Rise Time, $I_F = 1.4 \text{ mA}$ , $V_0 = 60 \text{ V}$ , $R_L = 1.5 \text{ k}\Omega$ , $PW = 50 \text{ ms}$	ms	0.80		
	$T_F$		Fall Time, $I_F = 1.4 \text{ mA}$ , $V_0 = 60 \text{ V}$ , $R_L = 1.5 \text{ k}\Omega$ , $PW = 50 \text{ ms}$	ms	0.4		
	$R_{\text{I-O}}$		Isolation Resistance, $V_{\text{I-O}} = 1.0 \text{ kVDC}$	$\Omega$	$10^9$		
	$C_{\text{I-O}}$		Isolation Capacitance, $V = 0 \text{ V}$ , $f = 1 \text{ MHz}$	pF		0.4	

Notes:

1. Test Circuit for Switching Time

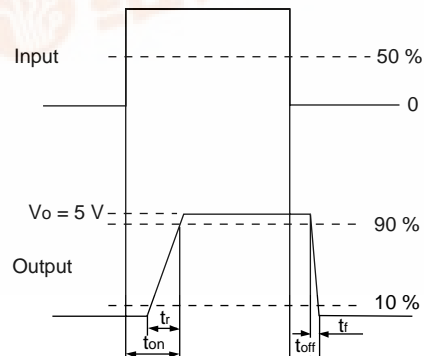
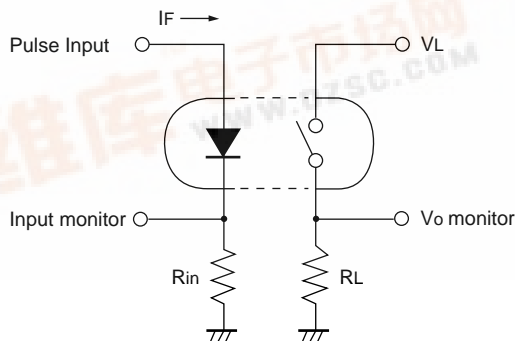

**ABSOLUTE MAXIMUM RATINGS<sup>1</sup>** (T<sub>A</sub> = 25°C)

SYMBOLS	PARAMETERS	UNITS	RATINGS
Diode			
I <sub>F</sub>	Forward Current	mA	50
V <sub>R</sub>	Reverse Voltage	V	5.0
P <sub>D</sub>	Power Dissipation	mW/ch	50
I <sub>FP</sub>	Peak Forward Current <sup>2</sup>	A	1
MOS FET			
V <sub>L</sub>	Break Down Voltage	V	260
I <sub>L</sub>	Countinuous Load Current	mA	200
I <sub>LP</sub>	Pulse Load Current <sup>3</sup>	mA	400
P <sub>D</sub>	Power Dissipation	mW/ch	180
Coupler			
BV	Isolation Voltage <sup>4</sup>	V <sub>r.m.s.</sub>	1500
P <sub>T</sub>	Total Power Dissipation	mW	460
T <sub>OP</sub>	Operating Ambient Temp.	°C	-40 to +80
T <sub>STG</sub>	Storage Temperature	°C	-40 to +100

Notes:

1. Operation in excess of any one of these parameters may result in permanent damage.
2. PW = 100 μs, Duty Cycle = 1%.
3. PW = 100 ms, 1 shot
4. AC voltage for 1 minute at T<sub>A</sub> = 25 °C, RH = 60% between input and output.

**OUTLINE DIMENSIONS** (Units in mm)

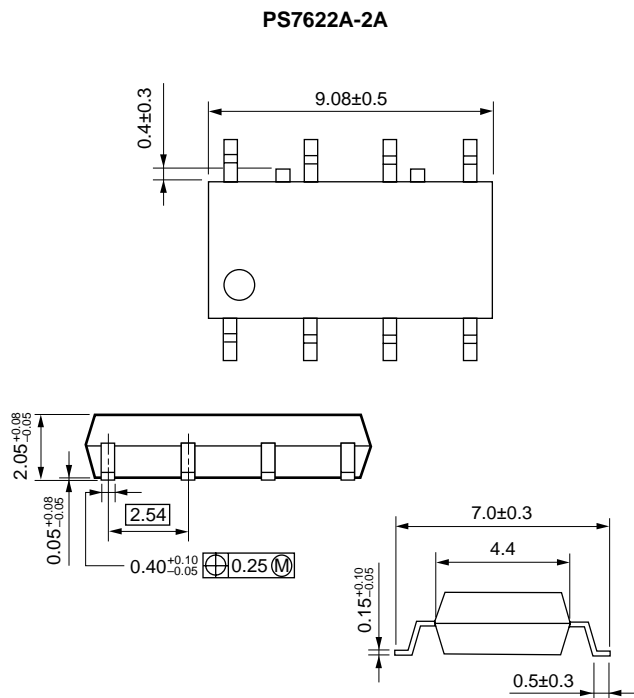

**RECOMMENDED OPERATING CONDITIONS**

PART NUMBER			PS7622A-2A		
SYMBOLS	PARAMETERS	UNITS	MIN	TYP	MAX
I <sub>F</sub>	LED Operating Current	mA	1	1.4	20
V <sub>F</sub>	LED off Voltage	V	0		0.5

TOP VIEW

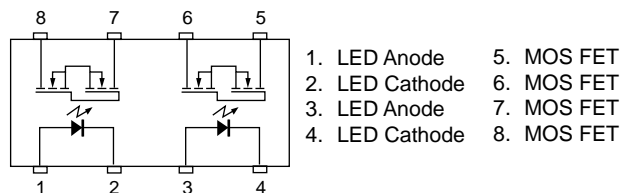

**ORDERING INFORMATION**

PART NUMBER	PACKAGE	PACKING STYLE	APPLICATION PART NUMBER <sup>1</sup>
PS7622A-2A	8-pin SOP	Magazine case 45 pcs	PS7622A-2A
PS7622A-2A-F3		Embossed Tape 1500 pcs/reel	
PS7622A-2A-F4			

Notes:

1. For the application of the Safety Standard, following part number should be used.

# PS7622A-2A

## TYPICAL PERFORMANCE CURVES ( $T_A = 25^\circ\text{C}$ , unless otherwise specified)

**MAXIMUM FORWARD CURRENT vs. AMBIENT TEMPERATURE**

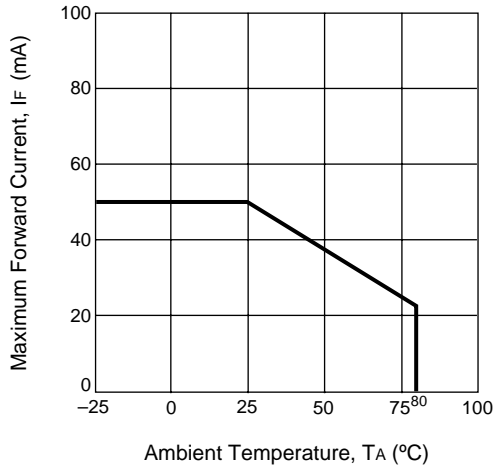

**MAXIMUM LOAD CURRENT vs. AMBIENT TEMPERATURE**

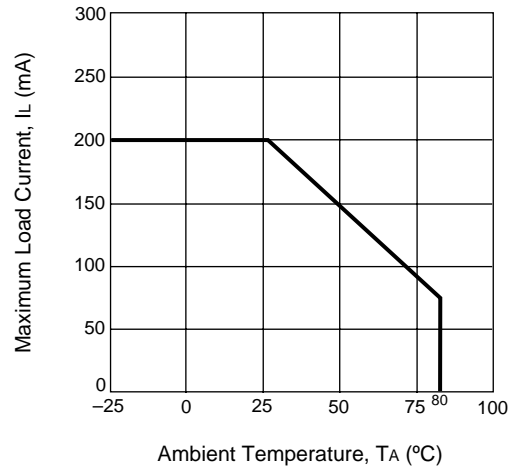

**FORWARD VOLTAGE vs. AMBIENT TEMPERATURE**

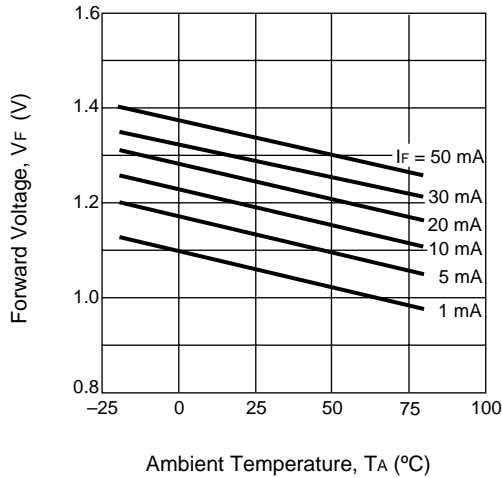

**OUTPUT CAPACITANCE vs. APPLIED VOLTAGE**

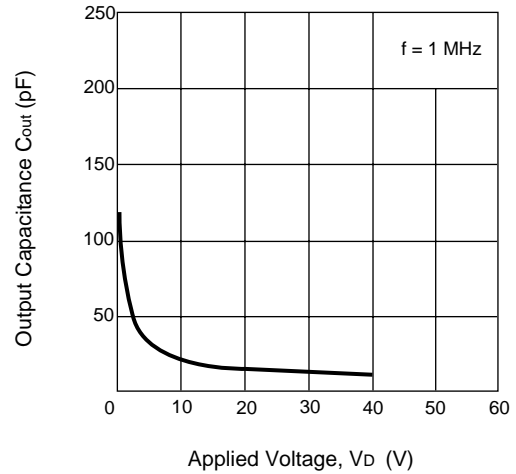

**OFF-STATE LEAKAGE CURRENT vs. AMBIENT TEMPERATURE**

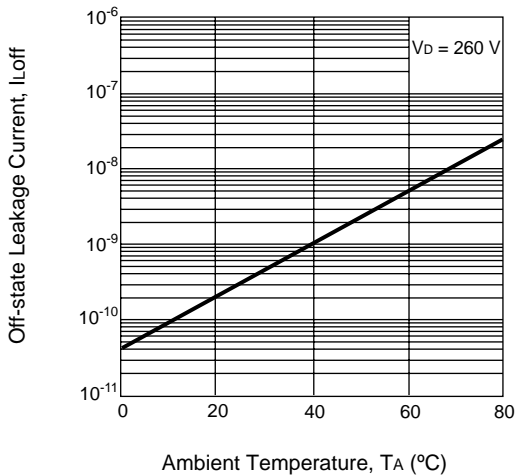

**LOAD CURRENT vs. LOAD VOLTAGE**

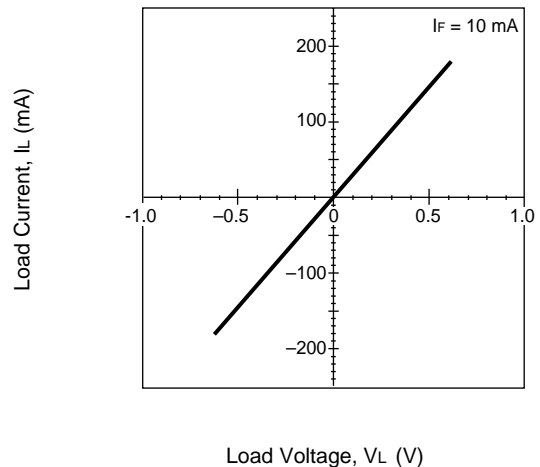

Remarks: The graphs indicate nominal characteristics.

**TYPICAL PERFORMANCE CURVES** ( $T_A = 25^\circ\text{C}$ , unless otherwise specified)

**NORMALIZED ON-STATE RESISTANCE vs. AMBIENT TEMPERATURE**

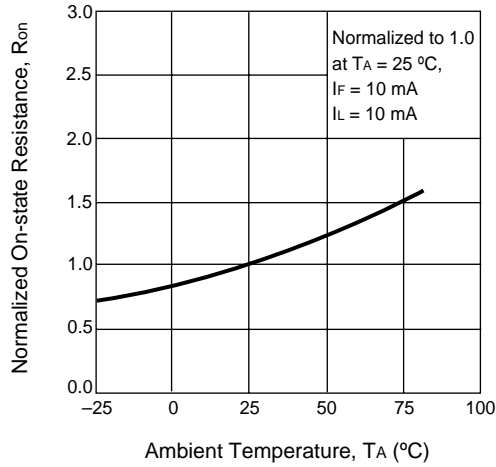

**ON-STATE RESISTANCE DISTRIBUTION**

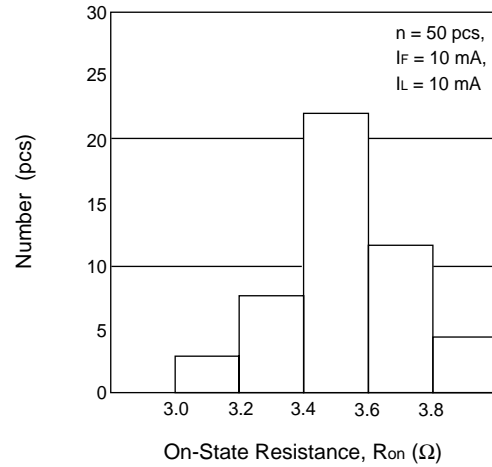

**TURN-ON TIME vs. FORWARD CURRENT**

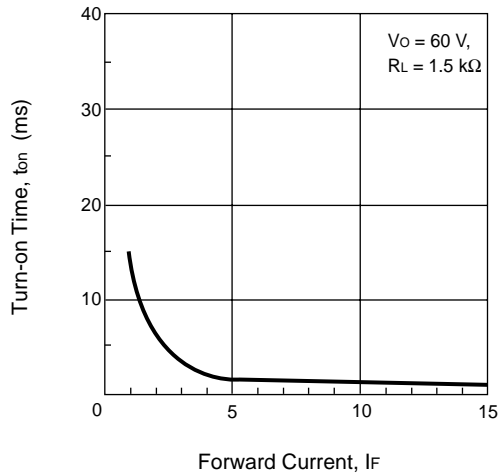

**TURN-OFF TIME vs. FORWARD CURRENT**

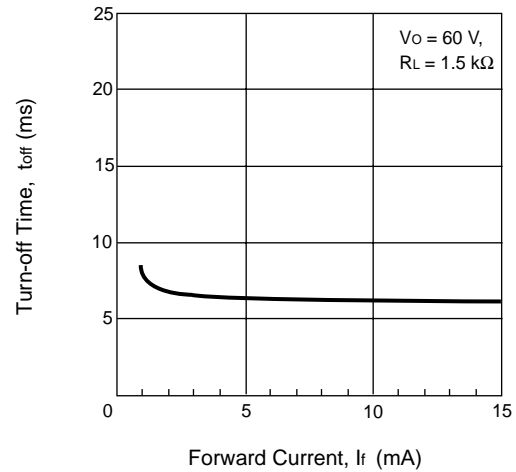

**TURN-ON TIME DISTRIBUTION**

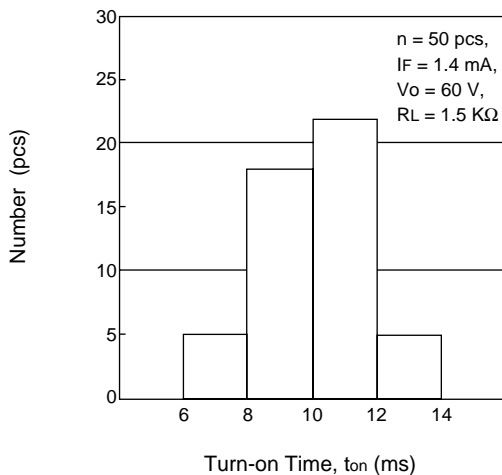

**TURN-OFF TIME DISTRIBUTION**

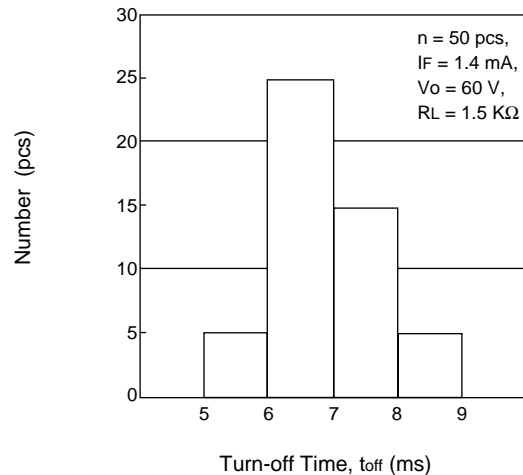

Remarks: The graphs indicate nominal characteristics.

# PS7622A-2A

## TYPICAL PERFORMANCE CURVES (TA = 25°C)

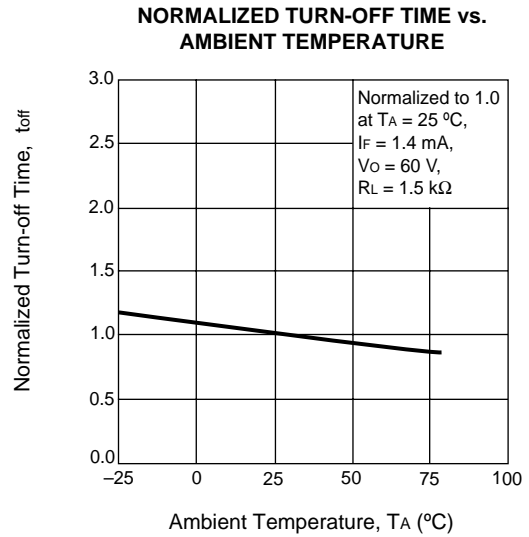
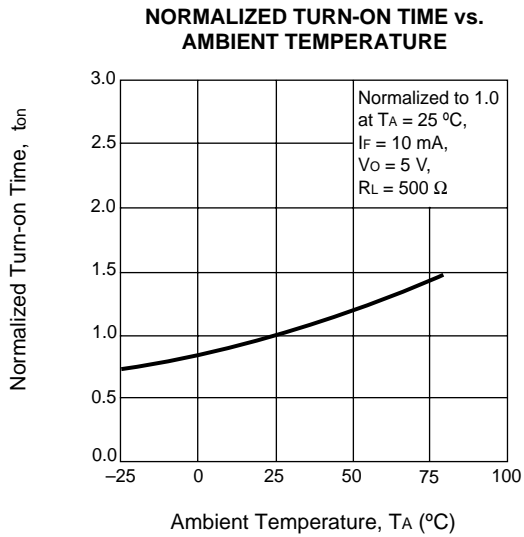

## TAPING SPECIFICATIONS (Units in mm)

### OUTLINE AND DIMENSIONS (TAPE)

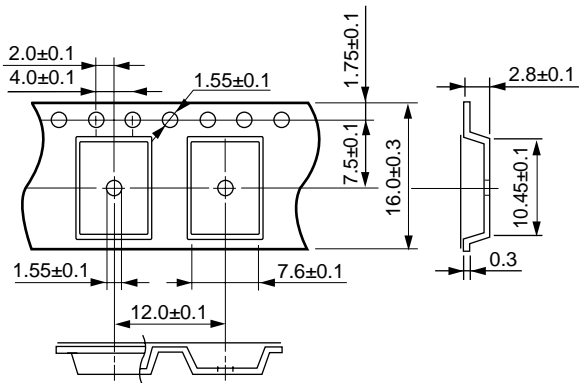

### OUTLINE AND DIMENSIONS (REEL)

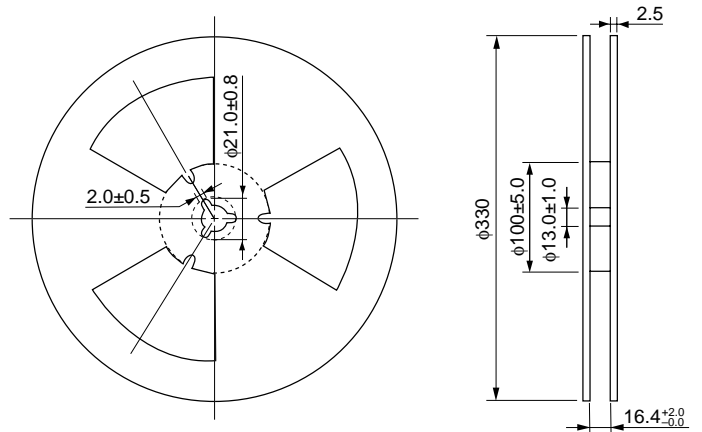

Notes:

1. Packing : 1500 pcs/reel F3, F4

### TAPE DIRECTION

PS7622A-2A-F3

PS7622A-2A-F4

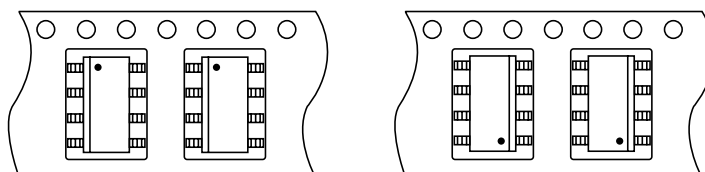

## RECOMMENDED SOLDERING CONDITIONS

### (1) Infrared reflow soldering

- **Peak reflow temperature**  
235 °C (package surface temperature)
- **Time of temperature higher than 210 °C**  
30 seconds or less
- **Number of reflows**  
Two
- **Flux**  
Rosin flux containing small amount of chlorine (The flux with a max. chlorine content of 0.2 Wt % is recommended)

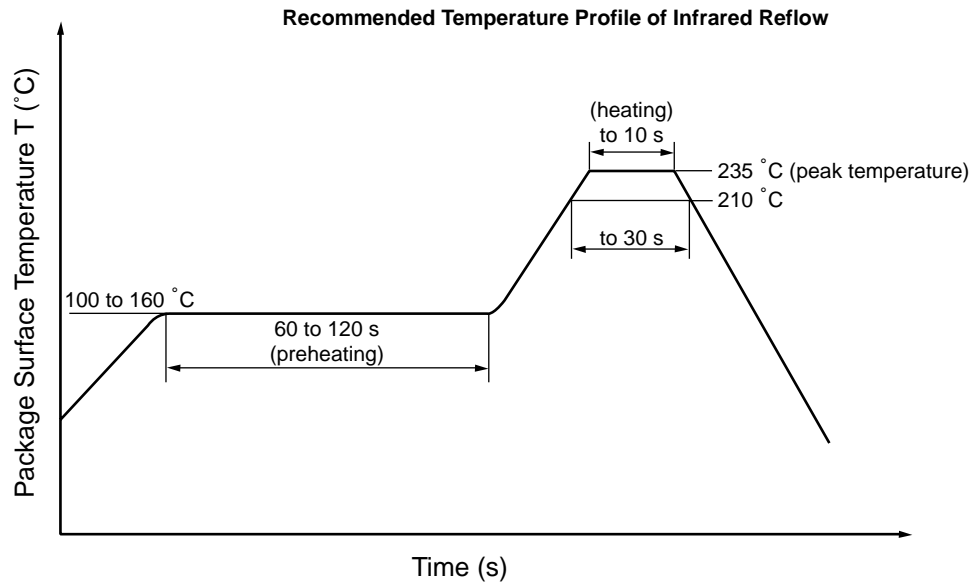

### (2) Dip soldering

- **Temperature**  
260 °C or below (molten solder temperature)
- **Time**  
10 seconds or less
- **Number of times**  
One (Allowed to be dipped in solder including plastic mold portion.)
- **Flux**  
Rosin flux containing small amount of chlorine (The flux with a max. chlorine content of 0.2 Wt % is recommended.)

### (3) Cautions

- **Fluxes**  
Avoid removing the residual flux with freon-based and chlorine-based cleaning solvent.  
Avoid shorting between portion of frame and leads.

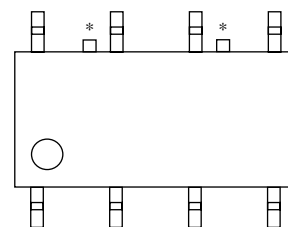

\* : Portion of frame

Life Support Applications

These NEC products are not intended for use in life support devices, appliances, or systems where the malfunction of these products can reasonably be expected to result in personal injury. The customers of CEL using or selling these products for use in such applications do so at their own risk and agree to fully indemnify CEL for all damages resulting from such improper use or sale.